

# 2021 CATALOG



# ONE SOURCE LIFT TRUCK PARTS PROGRAM KEEPS YOUR MIXED FLEET MOVING

**Have a mixed fleet of material handling equipment? Count on Crown to keep your fleet moving.**

Crown's service technicians are trained through our award winning Demonstrated Performance<sup>®</sup> Service Training. This training along with Crown's genuine Integrity Parts keep your Crown fleet efficient and well maintained.

Add Crown's One Source program and you'll also have access to more than 50 brands of material handling equipment.



**one**<sup>®</sup>  
**source**  
LIFT TRUCK PARTS

# Crown One Source

# Contents

|                   |   |
|-------------------|---|
| <b>Section 1</b>  | <b>Service Supplies</b>                                     |
| <b>Section 2</b>  | <b>Safety Equipment</b>                                     |
| <b>Section 3</b>  | <b>Warehouse</b>  |
| <b>Section 4</b>  | <b>Electric Truck Components</b>                            |
| <b>Section 5</b>  | <b>Internal Combustion (IC) Truck Components</b>            |
| <b>Section 6</b>  | <b>Work Assist®</b>   |
| <b>Section 7</b>  | <b>InfoLink®, PTH 50, Chain, Forks and Attachment Parts</b> |
| <b>Section 8</b>  | <b>Battery and Charger</b>                                  |
| <b>Section 9</b>  | <b>Tools</b>  |
| <b>Section 10</b> | <b>Hydraulic Components</b>                                 |
| <b>Section 11</b> | <b>Wheels and Tires</b>                                     |
| <b>Section 12</b> | <b>Crown Operator and Service Training</b>                  |
| <b>Section 13</b> | <b>Index</b>  |

- ▶ **Featured Crown promotional items, available through the Crown Store, listed on reverse side.**



### Flexfit Caps

C-CP-6577-IP (Parts)  
C-CP-6577-IS (Service)

- 92% polyester, 8% spandex
- Stretches to fit a wide variety of head sizes comfortably (6<sup>7</sup>/<sub>8</sub>"-7<sup>1</sup>/<sub>2</sub>" )



### LED Stealth Powercap - Black

C-CP-2117

- Integrated LED's for hands free lighting
- Up to 50 hours battery life
- Takes 2 CR2032 batteries, included
- Velcro closure; 100% cotton



### LED Beanie Cap - Black

C-CP-4148

- Integrated LED light panel - 4 bright white LED lights with 3 levels of brightness
- Uses 2 button cell batteries, included
- Acrylic knit beanie; hand wash only; remove light panel prior to washing



### Stainless Steel Insulated Tumbler

Part Number - S-MG-9842

- 20 oz. durable, double wall vacuum construction, copper insulation
- Keeps liquids hot or cold for considerable time period
- Push on lid with twist closure

### Sherpa Vacuum Tumbler

Part Number - S-MG-6621

- 11 oz. double wall construction, vacuum insulated
- Clear, press on lid with slide closure
- Works as a tumbler or drink insulator



### USB Memory Stick

Part Number - S-CP-29-BLK (black)  
Part Number - S-CP-29-ORG (orange)

- 16 Gigabytes - USB 2.0
- Swivel design flash drive-no cap to lose
- Easy to grip in rubberized casing
- Compact, portable data storage



### LED Flashlight

Part Number - S-FL-322304

- Pen light
- Metal clip included



S-TK-77010

### Scale Models

S-TK-5350 (Service Van)  
S-TK-77000 (ESR)  
S-TK-77010 (RM)  
S-TK-77700 (PE 4000)  
S-TK-77400 (SP 3000)  
S-TK-77900 (RC 5500)  
S-TK-77250 (SC)  
S-TK-77800 (C5)

- Model replicas
- Spin cast material
- Durable
- Moveable wheels
- Includes gift box



S-TK-77250

### Pen

Part Number - S-PN-V-FORCE (V-Force®)

Part Number - S-PN-IS (Service)

- Six-sided twist-action ballpoint has a textured metal grip, metal clip, spirit level, 3"/7cm ruler, small reversible Phillips and flathead screwdriver bit and a capacitive stylus that works with touch screen devices.



### Tape Measure

Part Number - S-TL-322269

- 25' tape measure
- Automatic blade lock for easy use
- Push button retrieval – quick, one finger operation
- Rubber coated housing for durability and long life
- 1-year warranty



### Silicone Card Holder

Part Number - S-CP-8277

- Attaches to cell phone with adhesion and holds business cards, credit cards, ID cards

### Counter Mats

Part Number - PF19102 (One Source)

Part Number - PF19540 (Integrity Parts & Service)



- Heavy duty, vynex
- 17" x 26"
- 1/8" thickness



## Section 1

# Service Supplies

### Contents

|   |      |
|---|------|
| Oils  | 1.02 |
| Fluids  | 1.04 |
| Grease  | 1.05 |
| Cleaners  | 1.07 |
| Aerosol Lubricants  | 1.11 |
| Bulk Service Supplies   | 1.12 |
| Wiper Blades  | 1.13 |
| Paint   | 1.14 |
| Gloves  | 1.14 |
| Cable Ties  | 1.16 |
|  Kneeling Pads | 1.16 |
| Industrial Wiping Products  | 1.17 |
| Can Liners  | 1.19 |
|  Floor Mats    | 1.20 |
| Tape/Packaging  | 1.21 |
| Chemicals   | 1.22 |
| Repair Filler   | 1.25 |
| Filter Cross Reference  | 1.26 |

### New Items:

35 lb. Grease Pump - p. 1.06  
Hand Sanitizer - p. 1.07  
Hand Cleaner Gel - p. 1.07  
Disinfectant Spray Q - p. 1.08  
Ethanol Surface Cleaner - p. 1.08  
Disinfectant Wipes - p. 1.10  
Performance® Disinfectant Wipes - p. 1.10  
Bucket Dispenser - p. 1.10  
Bucket Dispenser Lid - p. 1.10  
Centerfeed Wall Mount Dispenser - p. 1.10  
Stainless Steel Floor Dispenser - p. 1.10  
Spray Bottle - p. 1.13  
Crown Branded Kneeling Pad - p. 1.16  
Floor Mats - p. 1.20

Note: 1910.178(q)(5) (1998) of the Occupational Safety and Health Act (OSHA) requires that "All parts of any such industrial truck requiring replacement shall be replaced only by parts equivalent as to safety with those used in the original design."





**5W30 Motor Oil**

| Part Number | Sales Unit     |
|-------------|----------------|
| 363502-001  | Quart          |
| 363502-055  | 55 Gallon/Drum |

Superior high quality, multi-viscosity and fuel-efficient motor oil which exceeds manufacturers' warranty requirements. Meets API highest automotive standards for high temperature protection (API SN, SM, SL, SJ).

⚠ **WARNING:** Cancer and reproductive harm - [www.P65Warnings.ca.gov](http://www.P65Warnings.ca.gov)



**5W20 Motor Oil**

| Part Number | Sales Unit |
|-------------|------------|
| 363526-001  | Quart      |

Superior high quality, multi-viscosity and fuel-efficient motor oil which exceeds manufacturers' warranty requirements. Used on Hamech V34 lift trucks with a 2.4 Hyundai LP engine. Excellent low-temperature pumpability for protection during cold starts. Formulated to protect emissions control system catalysts. Keep engine clean by minimizing deposit formation. Improved gas mileage. Reduce oil consumption by reducing volatility and oil evaporation. API SN/RC, SM/SL, API SN, SJ, ILSAC GF-5, Ford (WSS-M2C945A, Chrysler (MS-6395).

⚠ **WARNING:** Cancer and reproductive harm - [www.P65Warnings.ca.gov](http://www.P65Warnings.ca.gov)



**10W30 Motor Oil**

| Part Number | Sales Unit     |
|-------------|----------------|
| 363500-001  | Quart          |
| 363500-101  | Gallon         |
| 363500-055  | 55 Gallon/Drum |

Superior high quality, multi-viscosity and fuel-efficient motor oil which exceeds manufacturers' warranty requirements. Provides the highest API performance level available for gasoline engines. Exceeds U.S. car and truck warranty requirements. Thermal stability to combat sludge build-up. Anti-rust and anti-foam additives.

⚠ **WARNING:** Cancer and reproductive harm - [www.P65Warnings.ca.gov](http://www.P65Warnings.ca.gov)



**Food Grade AW32 Hydraulic Oil**

| Part Number | Sales Unit     |
|-------------|----------------|
| 363516-005  | 5 Gallon       |
| 363516-055  | 55 Gallon/Drum |

Premium quality, ashless, food-grade lubricant specially developed for the lubrication of machinery in food processing and beverage plants. Registered by NSF

International as an H1 lubricant for use where incidental food contact may occur, also as an H2 lubricant for use in applications where there is no chance for incidental food contact. It also meets former 1998 USDA H1 & H2 guidelines, and is certified Kosher and Pareve. **Meets FDA 21 CFR 178.3570 for incidental food contact.** Used in hydraulic systems, rotary air compressors and circulating systems. Meets performance requirements of Parker Hannifin HPD and Vickers (Eaton). Excellent wear protection for critical system components. Good oxidation resistance to minimize sludge and varnish formation. Protects against rust & corrosion. Good water-separating properties to minimize the formation of emulsions.



**Hydraulic Oil DTE 24**

| Part Number | Sales Unit     |
|-------------|----------------|
| 063001-021  | 1 Gallon       |
| 063001-020  | 55 Gallon/Drum |

Mobil DTE 24 Series oils are supreme performance anti-wear hydraulic oils designed to satisfy a wide range of hydraulic equipment requirements.

**Note:** All products rated by the API will continually be upgraded to meet or exceed the newest standards. All products are blended using some of the highest quality base oils and additives available.



**Universal 10W30 Motor Oil**

| Part Number | Sales Unit |
|-------------|------------|
| 363510-001  | Quart      |
| 363510-101  | Gallon     |

Universal 10W-30 Heavy Duty Motor Oil exceeds the demands of API Service Classification CJ-4 / SN, CI-4 Plus. It meets the requirements of Mack EO-O Premium Plus, Volvo VDS-4, Renault VI RDL-3 and Detroit Diesel 93K218 (MBE 4000, MBE 900 Engines). It is a commercial multigrade oil for all-season use by fleets with diesel power or mix of gasoline and diesel power engines. This oil is designed to perform with currently marketed low and high sulfur diesel fuels. It provides exceptional low temperature flow properties to help cold start, enhanced oxidation stability, excellent TBN retention, superior viscosity retention, deposit control, superior engine protection and durability and outstanding soot handling ability.

⚠ **WARNING:** Cancer and reproductive harm - [www.P65Warnings.ca.gov](http://www.P65Warnings.ca.gov)



**15W40 Motor Oil**

| Part Number | Sales Unit     |
|-------------|----------------|
| 363523-001  | Quart          |
| 363523-101  | Gallon         |
| 363523-055  | 55 Gallon/Drum |

Heavy duty motor oil that is an ideal year-round oil for use in diesel and gasoline powered engines. Provides complete engine protection. Allows easy cold starting and guards against sludge, soot formation, rust and corrosion. Performs with low sulfur diesel fuels. Meets or exceeds the performance requirements for: API Service Classification CJ-4 / SN, CI-4 Plus, Allison C4, Caterpillar ECF-3, Cummins CES 20081, Detroit Diesel 93K218, Mack EO-0 Premium Plus, Mercedes-Benz p228.31, Volvo VDS 4, ACEA E7-04, Renault VI RDL-3 MTU Type I and II engine tests.

⚠ **WARNING:** Cancer and reproductive harm - [www.P65Warnings.ca.gov](http://www.P65Warnings.ca.gov)



**Mobil SHC Cibus Food Grade Low Temp Hydraulic Oil AW32**

| Part Number | Sales Unit |
|-------------|------------|
| 363530-005  | 5 Gallon   |

Mobil SHC Cibus Hydraulic Oil is a NSF H1 registered lubricant and it also complies with Title 21 CFR 178.3570 by the Food and Drug Administration (USA) for lubricants with incidental food contact and is accepted by the Canadian Food Inspection Agency for use in food processing facilities. This oil can be used as hydraulic, gear, bearing and circulating oils in all areas within the food processing plant. Pour Point -65° F, Flash Point 487° F.



**AW46 Hydraulic Oil**

| Part Number | Sales Unit     |
|-------------|----------------|
| 363527-101  | Gallon         |
| 363527-005  | 5 Gallon       |
| 363527-055  | 55 Gallon/Drum |

Quality anti-wear AW46 hydraulic oil designed to meet the requirements of fluid power systems. Formulated with a proven anti-wear additive that is effective in reducing pump wear. Excellent water separation, rust and corrosion prevention, oxidation stability and anti-foam properties. Meets or exceeds: Cincinnati Milacron P-68, P-69, P-70, Denison HF-1, HF-2, HF-0, Vickers 35VQ25M-2950-S, I-286-S, GM LH-04-1, LH-06-1, LH-15-1, DIN 51524, Part II, Toshiba Machinery.



**AW68 Hydraulic Oil**

| Part Number | Sales Unit     |
|-------------|----------------|
| 363531-101  | 1 Gallon       |
| 363531-005  | 5 Gallon       |
| 363531-055  | 55 Gallon/Drum |

Formulated to provide maximum pump life and trouble free service in industrial and mobile hydraulic systems. Provides long service in high-output hydraulic systems using vane, piston or gear pumps. Meets or exceeds following industry and OEM specifications: Vickers I-286-S, M-2950-S, 35VQ25, Denison TE6-C, HF-1, HF-2, HF-0, General Motors LH-04-1, LH-06-1, LH-15-1, Military Specifications 2075-T-H, 2110-T-H, 2135-T-H.



**Hydraulic Oil Additive**

Part Number Sales Unit

363537-001 | 1 Quart

Low friction additive for some hydraulic systems, relieves "stick-slip" on noisy hydraulic cylinders. (Not for use on machines which have a common sump for hydraulics, brake, and transmissions.) Compatible with hydraulic oils. Excellent wetting, combats stick-slip. Forms a stable lubricating film which reduces wear. Non-flammable.



**STP Oil Treatment Additive**

Part Number Sales Unit

363538-001 | 15 oz.

Fights friction to help protect against engine wear by providing a thicker cushion between moving engine parts. Use every oil change or in between. High-viscosity formula. Excellent for all cars, light trucks and SUVs. Resist motor oil breakdown. Counteract oil thinning by boosting viscosity. Increase anti-wear protection. Provides high stress lubrication protection. Add up to 1 bottle for every 4-5 quarts of oil as needed.



**Synthetic Compressor Oil**

Part Number Sales Unit

363524-001 | Quart

Quality compressor oil has four times the life of mineral-grade compressor oils. Synthetic, all-temperature blend that is designed to increase efficiency, reduce wear and prevent carbon buildup. For use with single and two stage reciprocating air compressors.

⚠️ **WARNING:** Cancer - [www.P65Warnings.ca.gov](http://www.P65Warnings.ca.gov)



**80W90 Gear Oil**

Part Number Sales Unit

363506-001 | Quart  
363506-005 | 5 Gallon  
363506-055 | 55 Gallon/Drum

High Performance, multi-purpose gear lubricant. Protects in the extreme pressure gear conditions encountered in heavy-duty equipment, trucks, farm tractors, passenger cars, earthmoving, and construction equipment. This oil is recommended where a multi-purpose gear oil or one suitable for API Services, MT-1, GL-5, Mack GO-H, GO-J are required.

⚠️ **WARNING:** Cancer - [www.P65Warnings.ca.gov](http://www.P65Warnings.ca.gov)



**Gear Oil**

Part Number Sales Unit

363536-005 | 5 Gallon

Use in ESR trucks. Demulsifying, fully-synthetic industrial gear oil with elevated aging resistance, excellent load-carrying capacity and wear protection. Great for low and high operating temperatures. Meets or exceeds the following: ISO 6743-6:CKD, AISE 224, FAG-FEG-Test 1-4 pass, DIN 51 517-3:CLP, ISO 12929: CKD, David Brown S1 53.101, SKF: pass (100 degrees C-test).

⚠️ **WARNING:** Cancer and reproductive harm - [www.P65Warnings.ca.gov](http://www.P65Warnings.ca.gov)



**75W-90 Synthetic Gear Oil**

Part Number Sales Unit

363514-001 | Quart  
363514-101 | Gallon  
063002-044 | 5 Gallon  
063002-047 | 55 Gallon/Drum

Mobil Delvac 1 Gear Oli 75W-90 is recommended for TSP 6000 and RC 5500 & SC5200 drive unit, standard or freezer trucks. Used in heavy-duty transmissions, axles and drives requiring API GL-5 and MT-1 performance. Off-highway industries including construction, mining, quarrying and agriculture. Used on-highway light and heavy-duty trucks, busses and vans.



**Oil Test Kit**

Part Number 363515 — Tests hydraulic and motor oil. Mail oil samples in for content test results. Comes with container for oil, mailing container and labels.

▼ **Test Kit Accessories**

**Suction Pump**

Part Number - 363515-001



**Tubing, 100 Feet**

Part Number - 363515-002



**Oil-Glo 30**

Part Number Sales Unit

363200-001 | Six 1 oz. Bottles  
363200-002 | 8 oz. Bottle  
363200-003 | 16 oz. Bottle  
363200-005 | 1 Gallon Pail  
363200-007 | 5 Gallon

363200-001



363200-003

Oil Glo 30 is a fluorescent dye used to aid in leak detection. It works with any host fluid and will not damage fluid. When added to a fluid system and circulated, the dye can help identify the source of a leak by glowing brightly when scanned with an UV inspection light. Oil Glo 30 glows white under ultraviolet light. Recommended usage ration is: 1 oz. dye to 8 gal. of fluid.

Part Number Description

363200-006 | UV Flashlight - Bulb Type LED 390  
363200-012 | UV Flashlight - Bulb Type 365nm, UV LED  
363200-008 | Safety Glasses - Amber Lens with Amber Temples  
363200-010 | Safety Glasses - Amber Lens with Black Temples

363200-006



363200-010



**Hydraulic Fluid Anti-Wear AW32**

**Part Number Sales Unit**

|            |                |
|------------|----------------|
| 363504-101 | Gallon         |
| 363504-005 | 5 Gallon Pail  |
| 363504-055 | 55 Gallon/Drum |

Excellent benefits are achieved when using our high quality Anti-Wear Hydraulic Fluid. Reduced filter blockage and sludge formation. Extended fluid and pump life. Improved durability of non-ferrous parts. Compatible with existing fluids.

Reduces downtime and maintenance cost. Meets the most severe requirements of hydraulic pump and equipment manufacturers including the following specifications: Denison HF-1, HF-2, HF-0, HG-14, TE6-C. Vickers I-286-S, M-2950-S. DIN 51524 Part 2. U.S. Steel 136, 127. Racine, variable volume pump. Vickers 35VQ25. Cincinnati Milacron P-68, P-69, P-70. General Motors LH-04-01, LH-06-01, LH 15-1. B.F. Goodrich 0152. Lee-Norse 100-1. Military Specifications 2075-T-H, 2110-T-H. Toshiba Machinery. Afnor 2-48-603.



**Hydraulic Fluid Low Temp**

**Part Number Sales Unit**

|            |                |
|------------|----------------|
| 363505-101 | 1 Gallon       |
| 363505-005 | 5 Gallon Pail  |
| 363505-055 | 55 Gallon/Drum |

Low temp hydraulic fluid meets the most severe requirements of hydraulic pump and equipment manufacturers. This high quality formulation has a long history of excellent performance and provides long, trouble-free service over a wide range of operating conditions. Operates in a wide range of temperatures and is designed for freezer applications. Meets military specs MIL PRF-5606 and NATO Code H-515.



**Automatic Transmission Fluid**

**Part Number Sales Unit**

|            |                |
|------------|----------------|
| 363503-001 | Quart          |
| 363503-055 | 55 Gallon/Drum |

Premium transmission fluid provides transmission protection, smooth shifting and long service life. Meets the requirements of most US and import specifications. Recommended for service in cars & light truck automatic transmissions where Dexron® III or Mercon® fluid is specified. Meets Allison C-4, ZF TEMPL 14 Heavy Duty.

**WARNING:** Cancer and reproductive harm - [www.P65Warnings.ca.gov](http://www.P65Warnings.ca.gov)



**Universal Hydraulic and Transmission Fluid**

**Part Number Sales Unit**

|            |                |
|------------|----------------|
| 363513-001 | Quart          |
| 063001-025 | 55 Gallon/Drum |

All season hydraulic and transmission fluid designed to meet the special lube requirements of most industrial trucks and implements. This fluid provides EP protection, oxidation and corrosion resistance, and moisture dispersion capability. Meets or exceeds the following fluid requirements. AGCO-ALLIS, ALLIS CHALMERS, DEUTZ-ALLIS Power Fluid 821 XL, 272843, 257541, 246634/ Allison C-3, C-4. International B-6 (Hy-Tran), B-5, Steiger SEMS 17001/ Caterpillar TO-2/ Denison HF-0, HF-1, HF-2/ John Deere J20D (Hy-Gard), J20C (Hy-Gard), J20A/B, J14B (303 Fluid)/ Kubota UDT Fluid.



**Mobil HD Transmission Fluid**

**Part Number Sales Unit**

|            |                |
|------------|----------------|
| 363522-001 | Gallon         |
| 363522-005 | 5 Gallon Pail  |
| 363522-055 | 55 Gallon Drum |

Mobiltrans HD 10W is an extra high performance, heavy duty transmission and drive-train lubricant engineered to meet or exceed the requirements of the rigorous Caterpillar TO-4 specification. This product line is uniquely designed to optimize the performance of powershift transmissions, gearboxes, and final drives. In hydraulic applications, they provide maximum protection even in high pressure systems.



**Mobil 424 Hydraulic Fluid**

**Part Number Sales Unit**

|            |               |
|------------|---------------|
| 363532-005 | 5 Gallon Pail |
|------------|---------------|

Extra high performance multipurpose tractor lubricant engineered to meet or exceed transmission and hydraulic fluid requirements. It is particularly well suited for reducing wet brake and Power Take-Off (PTO) chatter. SAE 80W. Meets Allison C4, API GL4, Vickers 35VQ25, Caterpillar TO-2, John Deere J20C. For Hamech / CLARK with Wet Disc Brakes.



**Dot 3 Brake Fluid**

**Part Number Sales Unit**

|            |              |
|------------|--------------|
| 363507-001 | Net wt 12 oz |
|------------|--------------|

National Brake Fluid meets SAE J1703 and FMVSS-116 specs.



**Dot 5 Brake Fluid**

**Part Number Sales Unit**

|            |              |
|------------|--------------|
| 063004-002 | Net wt 12 oz |
| 063004-003 | Gallon       |

Premium brake fluid that meets all required specs for use in Crown lift trucks.



**BlueDEF® Diesel Exhaust Fluid**

**Part Number Sales Unit**

|            |                |
|------------|----------------|
| 363525-002 | 2.5 Gallon     |
| 363525-055 | 55 Gallon Drum |

Mixture of high purity synthetic urea and deionized water. Contains no chemical additives or other compounds that could cause SCR system failure. Meets the quality standards established by the ISO-22241-1 for Diesel Exhaust Fluid. Certified by the American Petroleum Institute. For Diesel SCR engines.



**Antifreeze - Concentrated**

**Part Number Sales Unit**

|            |        |
|------------|--------|
| 363509-101 | Gallon |
|------------|--------|



**Antifreeze - 50/50**

**Part Number Sales Unit**

|               |        |
|---------------|--------|
| 363509-101-50 | Gallon |
|---------------|--------|

Universal formula for both automotive and heavy-duty diesel engines (ASTM D3306 and ASTM D4985). Green. Freezing Point - 34°F, Boiling Point 224° F.



**Dex-Cool Antifreeze/Coolant - Concentrated**

**Part Number Sales Unit**

|            |        |
|------------|--------|
| 363511-101 | Gallon |
|------------|--------|

DEX-COOL approved. Protection up to five years/150,000 miles. Patented formula contains no silicates, phosphates, borates, nitrates or amines. Excellent rust and corrosion protection. Helps prevent boil-overs and freeze-ups.

Protects all cooling system metal including aluminum. Organic Acid Technology (OAT) minimizes corrosion inhibitor depletion. Heavy duty extended life coolant specifically for diesel and heavy duty trucks. Not for use in RST or C5 trucks.



## Fluids

### Acustrip - Antifreeze Test Kit

| Part Number | Sales Unit     |
|-------------|----------------|
| 380030-189  | 70 Test Strips |



Make sure antifreeze in gas trucks does not reach an acidity level that ruins seals, gaskets and parts. Provides an exceptional, simple and economical way to test all types and colors of coolants for their freeze point, boil over, and corrosion protection. Perform the test in a minute without the need for separate instruments or laboratory analysis. Regular testing of antifreeze coolant minimizes downtime and its associated costs. Test before maintenance is performed. Meets or exceeds standards as outlined with: EVA Certification, GMP, AMRA/MAP UICS.

### De-Icer Concentrate

| Part Number | Sales Unit     |
|-------------|----------------|
| 363529-055  | 55 Gallon Drum |



Specially formulated to remove oil, road grime, and bugs from the windshield. The level of freezing protection is -20°F (-29°C).

### Mobil Delvac Extended Life Coolant 50/50 Premix

| Part Number | Sales Unit |
|-------------|------------|
|-------------|------------|

|            |                      |
|------------|----------------------|
| 363535-101 | Gallon               |
| 363535-005 | 6 (1) Gallon Bottles |
| 363535-055 | 55 Gallon Drum       |



Ready to use phosphate-free, silicate-free, nitrite-free and borate-free ethylene glycol base coolant that is designed to provide exceptional wet sleeve liner cavitation and corrosion protection of all cooling system metals.

It is formulated with organic corrosion inhibitors to provide total cooling system protection. Since the organic corrosion inhibitors do not readily deplete, it eliminates the need for supplemental coolant additives (SCAs) as required when using conventional coolants. Red in color. Use in RST &

**WARNING:** Reproductive Harm - [www.P65Warnings.ca.gov](http://www.P65Warnings.ca.gov)

### Windshield Washer Fluid

| Part Number | Sales Unit |
|-------------|------------|
|-------------|------------|

|            |                |
|------------|----------------|
| 300100-101 | 1 Gallon       |
| 063044     | 5 Gallon Pail  |
| 300100-055 | 55 Gallon Drum |



Windshield Washer Fluid is a conventional blue all-season windshield cleaner that is safe to use in any vehicle. Formula strengths -20°F.

**Note:** Windshield wiper blades available. See p. 1.13.

## Grease

Continued ▶

### High-Temp Grease

| Part Number | Sales Unit |
|-------------|------------|
| 364003      | 14 oz Tube |



High-temperature, multi-purpose, lithium complex grease with a high dropping point in excess of 500°F, insures retention where high temperatures are encountered. The special additive package insures high film strength, extreme pressure and anti-wear properties. Provides extra stability under storage and extreme service conditions. Application use: disc brake wheel bearings, universal joints, heavily loaded plain and rolling element bearings, and conveyor bearings. Red in color. NLGI Certified. Temperature range: -10°F to 325°F.

### Low Temperature Multi-Purpose Grease

| Part Number | Sales Unit |
|-------------|------------|
|-------------|------------|

|            |                         |
|------------|-------------------------|
| 063002-017 | Net wt 14 oz Tube       |
| 063002-046 | Case (40) - 14 oz Tubes |
| 063002-005 | 5 Gallon Pail           |



High performance grease for low temperature applications. Provides a high resistance to water wash and prevents wear in the coldest environments. Temperature range: -60°F to 250°F.

### Low-Temp Grease

| Part Number | Sales Unit |
|-------------|------------|
| 364004      | 14 oz Tube |



Low-temperature calcium grease is formulated for work under extreme pressure and has anti-wear additives to protect against rust and oxidation. Recommended for extremely low to medium temperatures. Amber in color. Temperature range: -65° to 225°F.

**WARNING:** Cancer - [www.P65Warnings.ca.gov](http://www.P65Warnings.ca.gov)

### JT6 Multi-Purpose Grease

| Part Number | Sales Unit |
|-------------|------------|
|-------------|------------|

|            |            |
|------------|------------|
| 363005-001 | 14 oz Tube |
|------------|------------|



Multi-purpose grease is extremely water resistant and water insoluble. Light-colored, low staining, and has a very low oil separation rate. Provides excellent anti-seize protection under high loads. Stays in place better than most other greases. It is fully rust and oxidation inhibited. A medium temperature range multi-purpose grease for extreme pressure loads, slow to medium speed bearings, greased chassis points, fifth wheels, and water pumps. Temperature Range: 0° to 250°F.

**WARNING:** Cancer - [www.P65Warnings.ca.gov](http://www.P65Warnings.ca.gov)

### Multi-Purpose Grease

| Part Number | Sales Unit |
|-------------|------------|
| 364001      | 14 oz Tube |



Multi-purpose, high performance, high temperature, lithium complex grease has a high dropping point in excess of 500°F, which insures retention where high temperatures are encountered. Grease has been formulated with a special additive package that ensures high film strength, extreme pressure (EP), and anti-wear properties. Application uses: wheel axles, fork slides, steering gears, reach assembly. Formulated for medium load applications. Blue in color. NLGI grade 2. Temperature range: -30°F to 325°F.

**WARNING:** Cancer - [www.P65Warnings.ca.gov](http://www.P65Warnings.ca.gov)

### Premium Multi-Purpose Lubricating Grease

| Part Number | Sales Unit |
|-------------|------------|
|-------------|------------|

|            |                     |
|------------|---------------------|
| 063002-025 | Net wt 14.5 oz Tube |
| 063002-026 | 35 lbs (5 gallons)  |



Mobilux EP 2 is a high performance, general-purpose industrial-type grease. This lithium hydroxystearate based grease is formulated to provide extra protection against wear, rusting and water washout. The recommended operating temperature range is from -20°C to 130°C, but it may be used at higher temperatures if the lubrication frequency is increased.

**DAYLube™ Food Grade NanoCeramic Lubricating Grease**

Part Number Sales Unit

363008-001 | 16 oz Tube

High-performance lubricating grease, NLGI No. 2, used where incidental contact with food is a possibility (NSF-H1). Excels in applications where resistance to water washout and broad operating temperatures are absolutely necessary. Operating range of -40° F to + 800°. The formulation of this product provides unsurpassed resistance to extreme pressures and corrosion, including salt spray. It contains no heavy metals or other environmentally undesirable additives.

⚠️ **WARNING:** Cancer - [www.P65Warnings.ca.gov](http://www.P65Warnings.ca.gov)



**Food Grade Multi-Purpose Grease**

Part Number Sales Unit

363002-002 | 10 oz Spray

363002-001 | 14 oz Tube

363002-005 | 37.5 lbs (5 gallons)

Advanced food grade grease specially formulated for the toughest food processing applications. Provides outstanding protection against wear and water washout, over a wide range of operating temperatures.

**Meets the highest food industry safety standards.**

Temperature range: -40°F to 392°F.



**Electric Motor Grease**

Part Number Sales Unit

363010-001 | 14.1 oz Tube

Mobil Polyrex EM grease is specially formulated for electric-motor bearings. Provides outstanding long-life, high-temperature lubrication of ball and roller bearings, excellent corrosion resistance, and advanced polyurea thickener protection for long electric motor life.



**Molykote BR2-Plus Multi-Purpose Extreme Pressure Grease**

Part Number Sales Unit

063002-024 | Net wt 14.1 oz Tube

063002-022 | 35 lb Pail

Extreme pressure bearing grease. Used for ball bearings, roller bearings, sleeve bearings, swivel joints, metal-to-metal, spindles, splines & shafts. Recommended using in mast channels.



**Molykote 44M Grease**

Part Number Sales Unit

063002-043 | Net wt 5.3 oz Tube

High temperature bearing grease with medium consistency. Contains silicone, resistant to oxidation, moisture and corrosive atmospheres, -40° F to 400° F.

⚠️ **WARNING:** Cancer - [www.P65Warnings.ca.gov](http://www.P65Warnings.ca.gov)



**Grease Gun, Lever Handle 10,000 PSI**

Part Number - 323000

Rugged pump with cast iron head for strength and durability. Heavy-duty plated steel lever handle. "Flip-Over" follower allows for a superior seal. For use with 16 ounce bulk or 14.5 ounce cartridge.

**Accessories:**

18" Whip Hose Extension - P.N. 323000-100

Hydraulic Coupler - P.N. 323000-101

*Note: Both parts can be added to 323000 to make a flex hose.*



**Grease Gun, Lever Handle 10,000 PSI**

Part Number - 323000-001

**Flex hose nozzle extension.** Rugged pump with cast iron head for strength and durability. Heavy duty plated steel lever handle. Barrel with flip follower allows for a superior seal. For use with 16 ounce bulk or 14.5 ounce cartridge.



**Grease Gun, Pistol Grip Handle 3,500 PSI**

Part Number - 323001

Flex-hose nozzle extension. Includes die-cast aluminum pump head, hose and follower.



**120 lb. Grease Pump**

Part Number - 363160

Use with 120 lb keg. Pump ratio: 60:1. Includes: pump, drum cover, follower plate, 1/4" x 6' high pressure hose, 3/8" x 6' air hose, filter regulator w/gauge, carrying handle which allows for easy movement of the grease pail.



**35 lb. Grease Pump**

Part Number - 363167

Designed for 35 lb. grease containers. Includes: 50:1 high pressure pump, control handle, Z-swivel, drum cover, follower plate and 8' outlet hose.



**Mast Lubrication Tool Kit**

Part Number - 363163

Use for greasing hard-to-reach areas on mast channels. The 6-12 ft pro-pole provides an extension for the chip brush to grease desired areas. Kit includes: Pro-Pole, Brush Holder, and 3" Straight Edge Chip Brush.

**Replacement Brush:** P.N. 363163-003



**Mobile Grease XHP005**

Part Number Sales Unit

063002-060 | 16 oz can

High-temperature grease for centralized grease application systems, gear lubrication, and where extreme-cold-temperature pumpability is important. NLGI grade 00. Used on steering gearbox on TSP6000/6500/7000.



**Spline Grease**

Part Number Sales Unit

063002-039 | 1 lb Jar

127801S | 1 oz Jar

Synthetic spline grease with PTFE & MoS2. Used specifically for Crown lift pump motor spline connection.



## Cleaners - Kit and Accessories

### Aerosol Products Kit\*

Part Number - 363121

Kit includes heavy-duty storage bucket with lid seat kit contents listed right. SDS sheets included in kit.



**Note:** PF14423 6-Pack Carrier. Holds up to 6 aerosols or soaps. Aerosols not included.

### ▼ Contents

| Part Number (Can) | Product                                      | Quantity |
|-------------------|--|----------|
| 363120            | 5 Gallon Storage Bucket with Lid Seat        | 1        |
| 363119-001        | Low V.O.C. Brake and Parts Cleaner           | 1        |
| 363115-001        | Premium Chain & Cable Lube                   | 1        |
| 363106-001        | Electrical Grade High Purity Contact Cleaner | 1        |
| 363104-001        | Penetrating Lubricant                        | 1        |
| 363108-001        | Premium Formula Multi-Purpose Grease         | 1        |
| 363110-001        | White Lithium Grease                         | 1        |
| 363109-001        | Choke & Carburetor Cleaner                   | 1        |
| 363105-001        | Degreaser & Cleaner                          | 1        |
| 363114-001        | All Purpose Cleaner                          | 1        |
| 363101-001        | Glass Cleaner                                | 1        |
| 363111-001        | Waterless Hand Cleaner                       | 1        |

⚠ **WARNING:** Cancer and reproductive harm - [www.P65Warnings.ca.gov](http://www.P65Warnings.ca.gov)



### 5 Gallon Storage Bucket with Lid Seat

Part Number - 363120

## Cleaners - Hand Cleaners and Accessories



### Waterless Hand Cleaner

Part Number Sales Unit

|            |                   |
|------------|-------------------|
| 363111-001 | Net wt 15 oz Tube |
| 363117-001 | Gallon Jug        |

Excellent for service technicians on the road, this waterless hand cleaner removes oil, grease, paint, and soil without the need to rinse with water. Keeps your hands from feeling raw or dry from over scrubbing.

**GREAT FOR ON THE ROAD TECHNICIANS**



### Pumiced and Smooth Hand Cleaner

Part Number Sales Unit

|            |                     |
|------------|---------------------|
| 363118-001 | Net wt 16 oz Bottle |
| 363112-001 | Gallon Jug          |

Pumice fortified hand cleaner that removes encrusted grime, soil, heavy grease, and embedded paints and stains. This one gallon jug can be dispensed with a hand pump or wall mounted shop dispenser.



### Soap Hand Pump - Gallon Jug

Part Number - 363123

Durable hand pump designed to remove the maximum amount of soap from each container, with its extra long tube.



### Wall Mounted Deluxe Soap Dispenser

Part Number - 363122

Heavy-duty stainless steel construction, with a pump that will not drip.



### Hand Sanitizer\*

Part Number

|            |                 |
|------------|-----------------|
| 365296-012 | 12 bottles/case |
|------------|-----------------|

Gel based hand sanitizer made with 70% USP cosmetic grade Ethyl Alcohol. Kills 99.99% of germs. Scent free, gentle formula keeps skin smooth. Does not irritate or dry the skin. Push cap for easy dispensing from 16.5 fluid ounce bottles.



**NEW!**



### Hand Cleaner Gel

Part Number Sales Unit

|            |                        |
|------------|------------------------|
| 363540-101 | 1 Gallon               |
| 363540-005 | 5 Gallon               |
| 363541     | Hand Pump for 5 Gallon |

Contains 80% alcohol which meets the CDC recommendations for a hand sanitizer. Formula includes glycerin to moisturize hands. Dispense on hands to help reduce bacteria. Rub hands together until dry.

**NEW!**

\*Available only to customers in USA

## Cleaners - Surface Cleaners



### Citra-Sol Degreaser

**Part Number Sales Unit**

363146-001 | Net wt 19 oz Can

Formulated with orange citrus solvents, this product removes grease, especially animal fats, oil, dirt, and scuff marks from floors. Can be used on porcelain and tile surfaces. Effective on sticky or tar based surfaces. Leaves no residue, and is safe on painted surfaces.



### All Purpose Cleaner

**Part Number Sales Unit**

363114-001 | Net wt 19 oz Can

Safe to use on almost any surface, this foaming cleaner contains a unique blend of detergent systems that cut through dirt, grime, and grease. Dries streak-free leaving surfaces crystal clear.



### Glass Cleaner

**Part Number Sales Unit**

363101-001 | Net wt 19 oz Can

Easy to use, fast-acting product that uses a clinging foam to break-up soils and hold them even on vertical surfaces. With an exclusive formulation using denatured alcohol and no ammonia, this product cleans thoroughly, dries quickly, requires no rinsing and leaves no streaks.



### Degreaser and Cleaner

**Part Number Sales Unit**

363105-001 | Net wt 19 oz Can  
363105-C01 | Net wt 19 oz Can - Canada  
363105-M01 | Net wt 19 oz Can - Mexico

Heavy-duty formula uses a high foaming spray for cleaning and clinging to vertical and horizontal surfaces. With a blend of ammonia and butyl, this fast-acting cleaner attacks and loosens dirt, greases, oils and much more from hard surfaces. May remove certain paints - test in small area.



### Disinfectant Spray Q

**Part Number Sales Unit**

363206-001 | Net wt 17 oz Can

Disinfectant is approved for use in health care, schools, hotels, restaurants, and commercial establishments. Use on high touch areas. Sanitizes soft, non-food contact surfaces. Lemon scent. Instructions: Wash surface before applying disinfectant if there is any visible soiling, contamination, or dirt. If the soiling is minimal, wipe surface down with disinfectant. Then re-apply the product again. The surface must be clearly wet with product as you apply it or spray it on. If you can't see that the surface is wet, reapply with enough product to thoroughly wet surface. Do not apply bleach after disinfecting spray. See product label for cloth and fabric materials and for more application instructions.



### Ethanol Surface Cleaner

**Part Number Sales Unit**

363542 | 5 Gallon Pail

Multi-purpose, 79% ethyl alcohol hard surface cleaner. Fill spray bottles and spray surface. Surface must remain wet for 60 seconds. Wipe or air dry. No rinsing required.



## Cleaners - Specialty Cleaners

Continued ▶



### Low V.O.C. Brake and Parts Cleaner

**Part Number Sales Unit**

363119-001 | Net wt 15 oz Can  
363119-M01 | Net wt 15 oz Can - Mexico

High performance non-chlorinated brake cleaner with no carbon tetrachloride or silicones. Accomplishes 3 times the work of an economy low V.O.C. brake cleaner. No more one can per brake job usage. Designed with a powerful blasting spray for fast acting, quick drying, and residue free results. Extension tube included.



### High V.O.C. Brake & Parts Cleaner

**Part Number Sales Unit**

363147-001 | Net wt 14 oz Can

Helps improve brake performance by instantly removing grease, oil, brake fluid, dirt and other residues from brake linings and drums. Application can be made without disassembling brake unit. Reduces disc brake squeal, and leaves no surface film. **NOTE: Can not use in the following states: California, Connecticut, Delaware, District of Columbia, Illinois, Indiana, Maine, Maryland, Massachusetts, Michigan, New Hampshire, New Jersey, New York, Ohio, Pennsylvania, Rhode Island, Utah and Virginia; also Canada.**



### 45% V.O.C. Brake & Parts Cleaner

**Part Number Sales Unit**

363154-001 | Net wt 14 oz Can  
363154-C01 | Net wt 14 oz Can - Canada

High performance non-chlorinated brake cleaner. Designed with a powerful blasting spray for fast acting, quick drying, and residue free results. More powerful than our Low V.O.C. Quickly removes brake fluid, grease, oil and other contaminants from brake linings & pads. Extension tube included. **Can not use in California, Delaware, Maryland, New Hampshire, Rhode Island or Utah.**



### Non-Flammable Brake Cleaner

**Part Number Sales Unit**

363116-001 | Net wt 18.05 oz Can  
363116-C01 | Net wt 18.05 oz Can - Canada  
363116-M01 | Net wt 18.05 oz Can - Mexico

High performance non-flammable brake cleaner. Designed with a powerful blasting spray for fast acting, quick drying, and residue-free results. Extension tube included. **Not for use in California and New Jersey.**



**Choke and Carburetor Cleaner**

**Part Number Sales Unit**

363109-001 | Net wt 14 oz Can

Instantly cleans carburetor throat, the automatic choke butterfly valve, the PCV valve and the linkage. This excellent cleaner is computer/oxygen sensor safe, leaves no sticky film, removes gum and varnish and helps increase gas mileage. Extension tube included.

⚠ **WARNING:** Reproductive Harm - [www.P65Warnings.ca.gov](http://www.P65Warnings.ca.gov)



**Final Step**

**Part Number Sales Unit**

363129-001 | Net wt 11 oz Can

363129-C01 | Net wt 11 oz Can - Canada

363129-M01 | Net wt 11 oz Can - Mexico

Great silicone release agent. Works on plastic, rubber, vinyl and metal. **Will not collect dirt.** No need to wipe off; spray on and leave it.

⚠ **WARNING:** Cancer and reproductive harm - [www.P65Warnings.ca.gov](http://www.P65Warnings.ca.gov)



**Sea Foam Engine Cleaner & Lube**

**Part Number Sales Unit**

363161 | Net wt 12 oz Can

For internal combustion engine use to clean carbon deposits from intake systems, intake valves and combustion chambers.



**Battery Cleaner**

**Part Number Sales Unit**

363124-001 | Net wt 18 oz Can

363124-C01 | Net wt 18 oz Can - Canada

363124-M01 | Net wt 18 oz Can - Mexico

Heavy duty industrial battery cleaner is engineered for fast, effective, economical maintenance of storage battery terminals, hold downs, cables and battery boxes. It detects leaks by changing from yellow to reddish purple when it comes in contact with acid. It neutralizes the acid.

⚠ **WARNING:** Cancer - [www.P65Warnings.ca.gov](http://www.P65Warnings.ca.gov)



**Battery Protector**

**Part Number Sales Unit**

363125-001 | Net wt 14 oz Can

363125-C01 | Net wt 14 oz Can - Canada

363125-M01 | Net wt 14 oz Can - Mexico

Heavy-duty industrial, non-methylene chloride, battery protector extends battery life and prevents corrosion. It provides an air-tight, waterproof seal, and resists oil, gasoline, dirt, grease and heat. Assures maximum electrical connectivity.



**Black Battery Reconditioner**

**Part Number Sales Unit**

363133-001 | Net wt 12 oz Can

Restores battery to original look. Formulated to adhere to battery plastics and metal. Ideal for automotive, truck and industrial batteries. When dry, paint finish resembles gloss of original molded plastic. Industrial grade, high solids for single coat coverage, outstanding hardness and durability, resists abrasion and heat. Fast drying. Other uses include battery hold-downs, trays and cases.



**Contact Cleaner**

**Part Number Sales Unit**

363128-001 | Net wt 13.5 oz Can

363128-M01 | Net wt 13.5 oz Can - Mexico

Excellent precision cleaning solvent that cleans and protects sensitive electronic components and contacts. Instantly penetrates hard-to-reach areas to safely dissolve dirt, dust, grease, flux and other contaminants on contact. Dries fast with zero residue. Regular use helps prevent contact failure and malfunction. Harmless to most plastics and paper tapes. 22,600 volts/mil dielectric strength. EPA snap approved.

⚠ **WARNING:** Cancer and reproductive harm - [www.P65Warnings.ca.gov](http://www.P65Warnings.ca.gov)



**Non-Flammable Electrical Grade High Purity Contact Cleaner**

**Part Number Sales Unit**

363106-001 | Net wt 10 oz Can

363106-M01 | Net wt 10 oz Can - Mexico

Electrical grade high purity contact cleaner is safe to use on almost any electrical product: Circuit Boards, Wire Terminals, Relays, Switches, Contacts, Circuit Breakers, Tuners, Potentiometers, Control Panels, Motors, and other electrical equipment. There are cheaper contact cleaners on the market, but they run a much greater risk of damaging the plastics, paints, and rubbers that surround most electrical components. This product can be used with the confidence that it will not damage the components you are trying to clean.



**DeoxIT Contact Cleaner**

**Part Number Sales Unit**

363136 | Net wt 5 oz Can

DeoxIT Contact Cleaner/Rejuvenator is a fast-acting deoxidizing solution that cleans, lubricates, protects and improves conductivity on metal connectors, contacts and surfaces. It is ideal for stationary and moving contacts and connectors. Stabilizes connections between similar and dissimilar metals.



**DeoxIT Gold**

**Part Number Sales Unit**

363155 | Net wt 5 oz Can

DeoxIT Gold is a unique contact cleaner, conditioner, enhancer, lubricant and protectant for PLATED metal surfaces. Improves conductivity, maintains optimum signal quality, reduces fretting & dendrite corrosion, and stabilizes connections between similar and dissimilar metals. It also reduces wear and abrasion, arcing, RFI and intermittent connections and improves connector performance/reliability. Ideal for gold plated surfaces. On oxidized surfaces, pre-treat with DeoxIT contact cleaner.

## Cleaners - Specialty Cleaners



363130-001

### Multi-Surface Cleaner Wipes\*\*

**Part Number Sales Unit**

363130-001 | 70 Wipes per Tub

363130-101 | 70-Wipe Refill Pack

Heavy-duty waterless cleaner wipes cut through tar, grease, wax, ink, paint, lubricants and adhesives. These non-scratching, citrus-scented towels are industrial strength. They don't leave an annoying residue.



363130-101 (Refill Pack)

\*\*Available for all customers



### Performance® Disinfectant Wipes\*

**Part Number Sales Unit**

365298-004 | 800 sheets/roll; 4 rolls/case

Antibacterial disinfecting wipes kills 99.9% of bacteria in 15 seconds. Great for disinfecting hard surfaces. Performance wipes are an excellent and cost effective way to disinfect your service vehicles, work areas, equipment, lunchrooms and restrooms. Bleach, Benzyl Alcohol, Citrus and Phenol free. EPA registered in all 50 states. Various dispensing options below.



### FLEX Wipes Disinfectant Wipes\*

**Part Number Sales Unit**

365217-006 | 75 sheets/canister; 6 canisters/case

Heavy duty disinfectant cleaner that cleans, disinfects and deodorizes in one labor saving step. Deodorizes by killing bacteria that cause offensive odors. Area proven "one-step" disinfectant - cleaner effective in the presence of 5% serum contamination. Does not contain bleach or ammonia; phosphate free. Kills 99.9% of bacteria in 15 seconds. Eliminates Pseudomonas, MRSA, CA-MRSA, E.coli, Campylobacter, VRE, Salmonella in 4 minutes.



### Bucket Dispenser\*

**Part Number Sales Unit**

365298-BKT | 1 Bucket

For use with Performance® Disinfectant Wipes. 10.75" diameter. Holds 2.9 gallons.



365219-006

### Dirteeze Wipes Rough and Smooth\*

**Part Number Sales Unit**

365219-006 | 80 sheets/tub; 6 tubs/case

365219-016 | 40 sheets/pack; 16 packs/case

365219-050 | 2 sheets/pack; 50 packs/box

Pre-moistened tear-proof spunlace material. Three times stronger than traditional pre-moistened wipes. Micro-beaded side for power scrubbing without scratching. Smooth side for wiping away. Good absorbency with liquid spills. Contains aloe vera for keeping hands moisturized.



365219-016



365219-050

### Bucket Dispenser Lid\*

**Part Number Sales Unit**

365298-LID | 1 Lid

For use with Performance® Disinfectant Wipes. Snap on lid with flip top cap. Lid and pail sold separately.



### Centerfeed Wall Mount Dispenser\*

**Part Number Sales Unit**

265298-WMT | Smoke gray dispenser

Wetworks® Pre-Moistened Centerfeed Towel Dispenser. For use with Performance® Disinfectant Wipes. 9.5"x9.5"x13".

NEW!



\*\*Available for all customers

### Disinfectant Wipes\*\*

**Part Number Sales Unit**

365217-101 | 80 sheets/pack

Single use disposable antibacterial wipes. Dual action cleaner and antibacterial. Kills 99.9% of germs; contains glycerin for moisturizing. Alcohol free. 6" x 8".



### Floor Dispenser with Hidden Waste Basket\*

**Part Number Sales Unit**

365298-FLR | Stainless Steel Waste Basket

Includes bucket and lid dispenser. For use with Performance® Disinfectant Wipes. Heavy gauge stainless steel; dispenses one wipe at a time from the top. Sleek design with hidden wastebasket.

\* Available only to customers in USA



### Chain and Cable Lube

**Part Number Sales Unit**

363107-001 | Net wt 15 oz Can

Premium-quality chain lube fortified with molybdenum disulfide and graphite, reducing friction and wear for longer chain life. This lubricating film will not wipe away under extreme pressure and high speeds. Especially recommended for exposed chains where contamination is a problem. Extension tube included.

**WARNING:** Cancer - [www.P65Warnings.ca.gov](http://www.P65Warnings.ca.gov)



### Premium Chain and Cable Lube

**Part Number Sales Unit**

363115-001 | Net wt 12 oz Can

363115-C01 | Net wt 12 oz Can - Canada

363115-M01 | Net wt 12 oz Can - Mexico

Superior, non-gumming premium oil that penetrates and lubricates all types of chains and cables. Prevents wear and rust. Loosens rusty nuts. Goes on clean, not running or dripping. Extension tube included.



### Dock Door Lube

**Part Number Sales Unit**

363145-001 | Net wt 16 oz Can

Superior lubricant that prevents friction and wear. This long-lasting, odorless, non-drip spray is safe on most plastics. Use on garage or overhead doors, hinges and pins, cables, springs, door tracks and chains, bearings and bushings, dock parts, hold-downs, rollers and toe guards. It's great in a variety of applications where a high quality lubricant is needed.

**SPRAYS  
8 FT.**



### Penetrating Lubricant

**Part Number Sales Unit**

363104-001 | Net wt 15 oz Can

363104-M01 | Net wt 15 oz Can - Mexico

Heavy-duty penetrant that cleans, loosens and protects faster than traditional products. The high concentration of AOLX in this product displaces water and reaches deep down to loosen nuts and bolts where corrosion and rust have collected. Inhibits rust and stops corrosion on battery terminals. Extension tube included.



### Channel Slide Lube

**Part Number Sales Unit**

363143-001 | Net wt 10.5 oz Can

High performance petroleum based lubricant, fortified with finely diffused moly sulfide to protect against wear and corrosion. Designed for use in industrial, heavy equipment, shop applications, automotive, marine, and farm. Use on inner slides and mast slides, torsion bars, fifth wheels, rails and rollers.

**WARNING:** Reproductive Harm - [www.P65Warnings.ca.gov](http://www.P65Warnings.ca.gov)



### Premium Formula Multi-Purpose Grease

**Part Number Sales Unit**

363108-001 | Net wt 13 oz Can

363108-C01 | Net wt 13 oz Can - Canada

363108-M01 | Net wt 13 oz Can - Mexico

Premium Formula Multi-Purpose Grease is a unique formulation of superior quality industrial lubricants in a convenient aerosol form. This product offers tremendous coating ability that withstands seizing, pounding out, wash-out and excessive wear. Timken rated (load bearing) to 65 lb and heat stable to 500 plus degrees.

**WARNING:** Cancer and reproductive harm - [www.P65Warnings.ca.gov](http://www.P65Warnings.ca.gov)



### White Lithium Grease

**Part Number Sales Unit**

363110-001 | Net wt 14 oz Can

363110-C01 | Net wt 14 oz Can - Canada

363110-M01 | Net wt 14 oz Can - Mexico

Highly concentrated, heavy-duty spray grease lubricant that leaves a long-lasting film and has excellent resistance to heat. Great for anything that squeaks, sticks or rusts. Extension tube included.

**WARNING:** Reproductive Harm - [www.P65Warnings.ca.gov](http://www.P65Warnings.ca.gov)



### Moly PTFE 45 Plus Lubricant

**Part Number Sales Unit**

363153-001 | Net wt 15 oz Can

This lubricant is formulated with PTFE and fortified with Moly to provide long lasting lubrication and protection from friction, wear and corrosion. The light viscosity of this product allows for deep penetration into hard to reach parts. Safe for use on most surfaces.



### Food Grade Machinery Lubricant

**Part Number Sales Unit**

363127-001 | Net wt 12 oz Can

Non-toxic, anti-wear fortified oil for use on bottling, dairy and food processing machinery. For chain, cables, conveyors, slides, o-rings, valves, pistons, seals and general lubrication. Certified OU Kosher Pareve. Manufactured with ingredients that comply with FDA regulation 21 CFR 178.3570 and 178.3530 for lubricants with incidental food contact.



### Food Grade Silicone Spray

**Part Number Sales Unit**

363126-001 | Net wt 11 oz Can

Can be used on food packaging and processing equipment as a protective anti-rust film, as a release agent on gaskets or seals of tank closures and as a lubricant for machine parts and equipment. This product can be used in contact with fresh, frozen, cooked or baked food products when used in accordance to prescribed regulations. **Manufactured with ingredients that comply with FDA regulation 21 CFR 178.3570 for lubricants with incidental food contact.**



**Citrus Degreaser Spray**

| Part Number  | Sales Unit              |
|--------------|-------------------------|
| 363156-001*  | Net wt 32 oz Bottle     |
| 363156-001-L | Label for 32 oz Bottle  |
| 363139       | 32 oz Bottle Hand Pump  |
| 363157-101   | 1 Gallon Refill         |
| 363158-101   | 1 Gallon (Concentrated) |

Instantly cleans grease, oils, and fats without the use of harsh acids, alkalines or petroleum solvents. For use on all washable surfaces. 100% biodegradable. Environmentally friendly with reusable containers and no ozone hazardous chemicals. More economical than aerosol cleaners especially when using the refills. Available in quart spray bottles and 1 gallon refills.

\*Note: Includes Pump Spray Nozzle

**55 Gallon Poly Drum (Empty)**

Part Number - 363141

Mix Ratio: 3 Gallons Citrus Degreaser Concentrate (P.N. 363158-101) per 52 Gallons Water  
Contents Label included



**55 Gallon Drum Plastic Pump**

Part Number - 363142

**Non-Flammable Brake Cleaner Bulk**

Part Number Sales Unit

|            |                |
|------------|----------------|
| 363150-005 | 5 Gallon       |
| 363150-055 | 55 Gallon Drum |

Formulated to effectively and quickly flush dust, grease, dirt, and oil from brake shoes, retaining springs, and backing plates. **NOTE: Not for use in California and New Jersey.**

⚠ **WARNING:** Reproductive Harm - [www.P65Warnings.ca.gov](http://www.P65Warnings.ca.gov)



**Stainless Steel & Plastic Pumps**

| Part Number | Sales Unit                                    |
|-------------|---|
| 363151-001  | 55 Gallon Stainless Steel Drum Pump           |
| 363151-002  | 5 Gallon Stainless Steel Bucket Pump          |
| 363142      | 55 Gallon Drum Plastic Pump (see photo above) |



**Floor and Vehicle Wash - Concentrated**

| Part Number | Sales Unit |
|-------------|------------|
| 363132      | 6 Gallon   |
| 363132-055  | 55 Gallon  |

Premium liquid floor cleaner and vehicle wash. It is formulated to remove grease and oils, dirt, road film and bug residue in one application without brushing. Safe on all paint at the suggested dilution, is free rinsing and leaves a shine. This wash is made from 100% biodegradable detergents and contains no caustics, phosphates, acids or solvents. Was designed for use with sweeper/scrubber floor cleaning units as well as pressure washing applications. This very concentrated product can be diluted 40:1 for light cleaning and 10:1 for heavy cleaning on vehicles. Works well in sweeper/scrubber floor cleaning units at 25:1 dilution. Use with a bucket and brush at 20:1 dilution ratio.



**Industrial Battery Cleaner/Neutralizing Wash Cleaner**

| Part Number | Sales Unit |
|-------------|------------|
| 300422-001  | Quart      |
| 300422      | 5 Gallon   |
| 300422-035  | 35 Gallon  |



- Dissolves corrosion, eliminates acid shorts
- Stops damaging corrosion
- Allows for reuse of wash water
- Safe to use on all industrial and starter batteries
- Neutralizing Wash Cleaner with color change, turns purple when acid is present and back to yellow when safe

Wash Cleaner color indicates when acid is neutralized.

|              |              |      |
|--------------|--------------|------|
| Acid Present | Neutralizing | Safe |
|--------------|--------------|------|

**Note:** Protective acid resistant goggles and gloves are recommended.

**Wash Water Neutralizer**

| Part Number | Sales Unit |
|-------------|------------|
| 300415-005  | 5 Gallon   |

Used to adjust pH in wash water and clean acid contaminated floors and equipment such as battery racks and delivery vehicles.

- Concentrated sulfuric acid neutralizer
- Non-corrosive and non-hazardous
- Allows for reuse of wash water
- Can also be used to remove acid from concrete floors
- Use on Reusable Battery Acid Floor and Counter Mat P.N. 300403-050 (see Section 8, Battery and Charger)



**Acid Spill Absorber and Neutralizer**

| Part Number | Sales Unit |
|-------------|------------|
| 300421      | 5 Gallon   |
| 300421-030  | 30 Gallon  |

- Specifically formulated to absorb and neutralize battery acid, with color change to show when acid is neutralized and safe for disposal
- Ideal for use in acid drip pans
- Safe and non-hazardous
- Sweeps up clean and dry, is not dusty like kitty litter/clay
- Durable easy to store container with resealable lid
- Instructions and SDS included  
See OSHA 1926.441 & 1910.173



**Non-Butyl Cleaner/Degreaser**

| Part Number | Sales Unit |
|-------------|------------|
| 063009-005  | 1 Gallon   |

General purpose cleaner for food processing plants, kitchens, factories, schools and office buildings. Its degreasing and deodorizing properties make it suitable for mopping, spraying or wiping. Use it to clean walls, floors, fixtures, equipment and utensils. Its low-sudsing formula contains rust inhibitors, rinses quickly and is fortified with builders for fast soil penetration and emulsification.





# Bulk Service Supplies

## SPRAY TOOLS

Sure Shot sprayers are an inexpensive way to apply bulk chemicals like cleaners, degreasers, penetrating oils, solvents and lubricants. They use readily available compressed air, instead of propellants, and because they are reusable you don't have to worry about disposal of empty cans. Not recommended for acids or paint.



### Sure Shot Sprayer - 32 oz.

**Part Number - 363148**

- Enameled steel
- Brass nozzles
- Can be used with oil and solvent-based materials
- Do not use water or water-based materials in steel sprayers
- 200 PSI maximum
- Includes (1) standard nozzle, 363148-003

#### Nozzle Options:

| Part Number | Description           |
|-------------|-----------------------|
| 363148-002  | Pin Stream            |
| 363148-003  | Cone Pattern Standard |
| 363148-004  | Fan Shape Flat        |



363148-002



363148-003



363148-004



### Sure Shot Sprayer Kit - 16 oz.

**Part Number - 363148-001**

- Electroless Nickel Plated Aluminum, w/ Plastic Cap, superior chemical resistance compared to base aluminum
- Slim design fits in hand easily
- 200 PSI Maximum
- Includes extra valve, seal, and nozzle assortment, including: 2 fine, 2 regular, 2 medium, 2 coarse and 1 pin stream nozzle



#### Nozzle Options:

| Part Number | Description              |
|-------------|--------------------------|
| 363148-006  | Medium Spray             |
| 363148-008  | Regular Spray (Standard) |
| 363148-009  | Coarse Spray             |



### Spray Bottle

| Part Number  | Sales Unit                            |
|--------------|---------------------------------------|
| 365460-004-S | 4 empty trigger spray bottles; 32 oz. |



## Wiper Blades

| Part Number   | Description            | Length | Vehicle                                       |
|---------------|------------------------|--------|---|
| 300099-001    | Standard-Conventional  | 22"    | Chevy Express 3500 Cargo Van /Ford F450 Truck |
| 300099-002    | Premium-Exact Fit      | 22"    | Chevy Express 3500 Cargo Van /Ford F450 Truck |
| 300099-003    | Winter-Chill           | 22"    | Chevy Express 3500 Cargo Van /Ford F450 Truck |
| 300099-004    | Premium-Pro            | 21"    | Chevy Silverado 3500 Truck                    |
| 300099-005    | Winter Beam-Ice        | 22"    | Chevy Silverado 3500 Truck                    |
| 300099-006    | Right-Premium-Pro      | 21"    | Ford Transit T350 Van                         |
| 300099-007    | Left-Premium-Pro       | 27"    | Ford Transit T350 Van                         |
| 300099-008    | Right-Winter Beam-Ice  | 21"    | Ford Transit T350 Van                         |
| 300099-008    | Left-Winter Beam-Force | 28"    | Ford Transit T350 Van                         |
| 300099-020    | Premium-Exact Fit      | 20"    | Ford Full Size Service Van                    |
| 300099-020-01 | Winter Premium-Chill   | 20"    | Ford Full Size Service Van                    |

(One blade per package)

**Note:** Windshield washer fluid part number is 300100-101.



300099-001



300099-002



300099-003



300099-004



300099-005



300099-006



300099-007



300099-008



300099-020























300099-020-01

SERVICE SUPPLIES





# Paint

## Aerosol Paint Cans - Net wt. 12 oz.

| Color                               | Individual   | Case (12 Cans) |
|-------------------------------------|--|----------------|
| Crown 88 Dark Gray                  | 063011-007   | 063011-017     |
| Crown 94 Medium Gray                | 063011-008   | 063011-018     |
| Crown 94 Beige                      | 063011-009   | 063011-019     |
| Crown Bright Beige                  | 063011-033   | 063011-034     |
| Crown Medium Silver                 | 063011-037   | 063011-038     |
| Crown Alpine White                  | 063011-025   |                |
| Crown Light Graphite                | 063011-027   |                |
| Crown Crystal Silver                | 063011-029   |                |
| Crown Control Orange                | 063011-031   |                |
| Crown 88 Blue                       | 063011-010   |                |
| Crown Motor Silver                  | 063011-035   |                |
| Crown 90 Orange                     | 063011-002   |                |
| Crown 90 Yellow                     | 063011-021   |                |
| Hamech 8782539 Yellow               |  363018-002   |                |
| Hamech 8772306 Black                |  363018-003   |                |
| Hyster HY1345809 Nugget Yellow      |  363018-004   |                |
| Kalmar/Tusk 8776201 Red             |  363018-001   |                |
| Komatsu 3EE-97-21110L Blue          |  363018-012   |                |
| Komatsu 3ZB-97-21110L Gray          |  363018-013   |                |
| Komatsu 3EB-99-A6110 Natural Yellow |  363018-019   |                |
| Komatsu 3EB-99-A6120 Black          |  363018-003   |                |
| Komatsu 3EB-99-A6130 Summer Green   |  363018-018   |                |
| Komatsu 3EB-99-31120 2K Blue        |  363018-014   |                |
| Komatsu 3EB-99-31110 2K Yellow      |  363018-015   |                |
| Komatsu 3EB-99-31130 2K Teal Green  |  363018-016   |                |
| Raymond 1053174-001 High Gloss Red  |  363018-010   |                |
| Raymond 990-181 93 Red/Orange       |  363018-011  |                |
| Raymond 990-164 Black               |  351096-307 |                |
| Toyota 90900-U9024-71 New Orange    |  363018-007 |                |
| Toyota 90900-U9022-71 Black         |  363018-008 |                |
| Toyota 90900-U9023-71 Gray          |  363018-009 |                |
| Yale 310120350 Bright Gold          |  363018-005 |                |
| Yale 310120348 Bright Parchment     |  363018-006 |                |

**WARNING:** Cancer and reproductive harm - [www.P65Warnings.ca.gov](http://www.P65Warnings.ca.gov)

## Quart, Gallon and 5 Gallon Paint Cans#

| Color  | Quart      | Gallon     | 5 Gallons  |
|--|------------|------------|------------|
| Crown 88 Dark Gray   | 063016-007 | 063000-104 | 063000-040 |
| Crown 94 Medium Gray   | 063016-008 | 063000-106 | 063000-034 |
| Crown 94 Beige   | 063016-009 | 063000-108 |            |
| Crown Bright Beige   | 063016-029 | 063000-105 | 063000-069 |
| Crown Control Orange   |            | 063000-103 |            |
| Crown Alpine White   | 063016-025 | 063000-151 |            |
| Hamech 8782541 Yellow       |            | 363017-002 |            |
| Hamech 8772305 Black        |            | 363017-003 |            |
| Kalmar/Tusk 8776201 Red     |            | 363017-001 |            |
| Komatsu 3EB-99-A6220 Black  |            | 363017-003 |            |

#Note: Spray equipment required.

**WARNING:** Cancer and reproductive harm - [www.P65Warnings.ca.gov](http://www.P65Warnings.ca.gov)



## Adhesive Eraser



| Part Number | Description              |
|-------------|--------------------------|
| 380030-191  | 3M Adhesive Eraser Wheel |

Easy to use tool for removing adhesives and films from painted surfaces. Will not scratch or damage acrylic enamel or urethane paint. For use with electric drill. Eraser wheel dimensions: 4" x 3/8". Attachment: 3/8".

## Gloves

Continued ▶

### Nitrile, Latex & Vinyl Gloves



| Part Number | Description                        | Size     |
|-------------|------------------------------------|----------|
| 300075-006  | Nitrile, 5 mil, Powder Free, Black | Small    |
| 300075-001  | Nitrile, 5 mil, Powder Free, Black | Medium   |
| 300075-002  | Nitrile, 5 mil, Powder Free, Black | Large    |
| 300075-003  | Nitrile, 5 mil, Powder Free, Black | X-Large  |
| 300075-004  | Nitrile, 5 mil, Powder Free, Black | XX-Large |
| 300076-006  | Nitrile, 5 mil, Powdered, Blue     | Small    |
| 300076-001  | Nitrile, 5 mil, Powdered, Blue     | Medium   |
| 300076-002  | Nitrile, 5 mil, Powdered, Blue     | Large    |
| 300076-003  | Nitrile, 5 mil, Powdered, Blue     | X-Large  |
| 300073-001  | Latex, 5 mil, Powder Free, Natural | Medium   |
| 300073-002  | Latex, 5 mil, Powder Free, Natural | Large    |
| 300073-003  | Latex, 5 mil, Powder Free, Natural | X-Large  |
| 300077-001  | Vinyl, Powdered, Clear             | Medium   |
| 300077-002  | Vinyl, Powdered, Clear             | Large    |
| 300077-003  | Vinyl, Powdered, Clear             | X-Large  |

Note: 100 per package

### Latex Gloves\*

| Part Number   | Sales Unit      | Size    |
|---------------|-----------------|---------|
| 365248-001-10 | 10 boxes of 100 | Medium  |
| 365248-002-10 | 10 boxes of 100 | Large   |
| 365248-003-10 | 10 boxes of 100 | X-Large |

Heavy duty, industrial grade. 8 mil. Non-sterile. Powder free.



### Diamond Grip Latex Gloves

| Part Number | Sales Unit     | Size    |
|-------------|----------------|---------|
| 300151-000  | 100 gloves/box | X-Small |
| 300151-006  | 100 gloves/box | Small   |
| 300151-001  | 100 gloves/box | Medium  |
| 300151-002  | 100 gloves/box | Large   |
| 300151-003  | 100 gloves/box | X-Large |



Better elasticity and puncture resistance. Glove is textured along the length of the fingers for improved grip and thicker at the fingertips for added protection. Palm thickness is 6.3 mils and the finger thickness is 7.9 mils. Chlorinated glove allows for quick donning, particularly in wet environments. Powder-free glove leaves no residue, helping to reduce the risk of spreading bacteria.

\*Available only to customers in USA

**Nitrile Pyramid Grip Industrial Gloves\***



**NOW IN BLACK**



SUPPLIES MAY BE LIMITED

| Orange Part No. | Black Part. No. | Sales Unit      | Size     |
|-----------------|-----------------|-----------------|----------|
| 365225-001-10   | 365225-BK1-10   | 10 boxes of 100 | Medium   |
| 365225-002-10   | 365225-BK2-10   | 10 boxes of 100 | Large    |
| 365225-003-10   | 365225-BK3-10   | 10 boxes of 100 | X-Large  |
| 365225-004-10   | 365225-BK4-10   | 10 boxes of 100 | XX-Large |

Palm and finger textured; deep textured for better gripping both in wet and dry applications. Available in orange and black. Cuff: 5 mil. Palm: 6.5 mil. Latex free. Powder free. Standard: Meets ASTM D6319, meets FDA CFR Title 21 Indirect Food Additive Regulations Part 174-178.

**Cotton Jersey Gloves\***



| Part Number | Sales Unit | Size     |
|-------------|------------|----------|
| 365240-012  | 12 pairs   | One Size |

General duty. Can be used alone or as glove liners. Brown cotton jersey. Knit cuff.

**Nitrile Gloves\***



| Part Number   | Sales Unit | Size    |
|---------------|------------|---------|
| 365241-003-12 | 12 pairs   | Large   |
| 365241-004-12 | 12 pairs   | X-Large |

15 mil green nitrile. Nitrile flock, lined. 13" length.

**Foam Nitrile Coated Cut Resistant Gloves\***



| Part Number   | Sales Unit | Size     |
|---------------|------------|----------|
| 365229-001-12 | 12 pairs   | Medium   |
| 365229-002-12 | 12 pairs   | Large    |
| 365229-003-12 | 12 pairs   | X-Large  |
| 365229-004-12 | 12 pairs   | XX-Large |

13 gauge High Performance Polyethylene (HPPE) provides cut resistance. Foam nitrile palm dip provides protection from abrasion in wet or dry conditions. Seamless design provides a comfortable fit. Meets EN 388:2003 standards for Abrasion Resistance, Blade Cut, Tear, and Puncture (4 5 4 3). ANSI cut level 4, CE cut level 5.

**Nitrile Foam Coated Gloves\***



| Part Number   | Sales Unit | Size    |
|---------------|------------|---------|
| 365236-001-12 | 12 pairs   | Medium  |
| 365236-002-12 | 12 pairs   | Large   |
| 365236-003-12 | 12 pairs   | X-Large |

High-dexterity foam nitrile coated. Gray nylon knit shell. Excellent grip.

**Full Latex Coated Waterproof Gloves\***



| Part Number   | Sales Unit | Size     |
|---------------|------------|----------|
| 365227-001-12 | 12 pairs   | Medium   |
| 365227-002-12 | 12 pairs   | Large    |
| 365227-003-12 | 12 pairs   | X-Large  |
| 365227-004-12 | 12 pairs   | XX-Large |

13 gauge orange nylon shell. Full latex, waterproof coating. Black sandy foam palm dip. Good abrasion resistance. Elastic wrist. Tested to EN388:2015 standards for Abrasion Resistance, Blade Cut, Tear and Puncture (3 1 3 1).

**Cotton Poly Coated Flex Gloves\***



| Part Number   | Sales Unit | Size    |
|---------------|------------|---------|
| 365237-001-12 | 12 pairs   | Medium  |
| 365237-002-12 | 12 pairs   | Large   |
| 365237-003-12 | 12 pairs   | X-Large |

Excellent abrasion resistance with a high level of dexterity. Heavy latex with textured palm and fingers. String knit, palm dipped in latex, knit wrist.

**Neoprene Over Latex Gloves\***



| Part Number   | Sales Unit | Size    |
|---------------|------------|---------|
| 365239-002-12 | 12 pairs   | Large   |
| 365239-003-12 | 12 pairs   | X-Large |

Heavyweight neoprene over latex, flock lined - 28 mil. Chemical/oil resistant. Outstanding dexterity. Impermeable to gases, vapor and moisture.

**Polyurethane-Coated, Nylon Knit Gloves\***



| Part Number   | Sales Unit | Size     |
|---------------|------------|----------|
| 365228-006-12 | 12 pairs   | Small    |
| 365228-001-12 | 12 pairs   | Medium   |
| 365228-002-12 | 12 pairs   | Large    |
| 365228-003-12 | 12 pairs   | X-Large  |
| 365228-004-12 | 12 pairs   | XX-Large |

Polyurethane palm coating is tough and durable. Gray nylon knit shell. Durable, but still allows for excellent tactile feel.

\*Available only to customers in USA

## Gloves

### Leather Palm Gloves\*

| Part Number   | Sales Unit | Size    |
|---------------|------------|---------|
| 365238-012    | 12 pairs   | Large   |
| 365238-003-12 | 12 pairs   | X-Large |

Made from select shoulder leather. Leather palms, fingers and knuckle strap. 2½" rubberized safety cuff. Safety Orange back and cuff.



### Welding Gloves\*

| Part Number | Sales Unit | Size     |
|-------------|------------|----------|
| 365473      | 1 pair     | One Size |

Economy welding glove. 13" length. Fully cotton lined and welted cowhide.



### Drivers Gloves\*

| Part Number   | Sales Unit | Size    |
|---------------|------------|---------|
| 365242-002-12 | 12 pairs   | Medium  |
| 365242-003-12 | 12 pairs   | Large   |
| 365242-004-12 | 12 pairs   | X-Large |

Select pigskin drivers gloves. Shirred back. Keystone thumb. Unlined.



### Mechanics Insulated Gloves\*

| Part Number | Sales Unit | Size    |
|-------------|------------|---------|
| 365471-001  | 1 pair     | Medium  |
| 365471-002  | 1 pair     | Large   |
| 365471-003  | 1 pair     | X-Large |

High dexterity mechanics gloves. Full fingertip and knuckle protection. Insulated with 3M thinsulate. Adjustable velcro closure & padded palm.



### Crown Mechanics Gloves



| Part Number | Description             | Size    |
|-------------|-------------------------|---------|
| 300094-001  | Integrity Service Black | Medium  |
| 300094-002  | Integrity Service Black | Large   |
| 300094-003  | Integrity Service Black | X-Large |

Lightweight, yet durable for the toughest tasks. Synthetic leather palm extends life of the glove while the spandex back provides breathability. Reinforced fingertips for maximum durability. Easy slip-on, open cuff design. Sold by the pair.

### Crown Mechanics Fingerless Gloves

| Part Number | Sales Unit | Size     |
|-------------|------------|----------|
| 152892-014  | 1 pair     | Medium   |
| 152892-011  | 1 pair     | Large    |
| 152892-012  | 1 pair     | X-Large  |
| 152892-013  | 1 pair     | XX-Large |

Cow grain leather palm extends life of the glove while the spandex back provides breathability. Fingerless, double stitched for maximum durability. Velcro wrist closure.



\*Available only to customers in USA

## Cable Ties



| Part Number | Length (in) | Width (in) | Maximum Wire Bundle | Color   | Qty Per Box |
|-------------|-------------|------------|---------------------|---------|-------------|
| 365003-002  | 3.62        | 0.09       | 0.63                | Natural | 1000        |
| 365003-003  | 7.44        | 0.19       | 1.75                | Natural | 1000        |
| 365003-004  | 5.60        | 0.14       | 1.38                | Black   | 1000        |
| 365003-005  | 11.40       | 0.14       | 3.00                | Black   | 1000        |
| 18108-X     | 14.00       | 0.3125     | 4.00                | Black   | 100         |

## Kneeling Pads



### Crown Branded Kneeling Pad\*

| Part Number | Description            | Sales Unit |
|-------------|------------------------|------------|
| 365472      | 1" thick; 7.5" x 15.5" | 1/each     |

Lightweight EVA foam cushioning. Built-in handle for easy storage. Helps reduce knee and back strain.



### Kneeling Pad\*

| Part Number | Description         | Sales Unit |
|-------------|---------------------|------------|
| 365472-004  | 1" thick; 14" x 21" | 4/case     |

Made of Nitrile blend resilient foam. Non-conductive and minimal water absorption. Lightweight with built-in handle for easy storage.



\*Available only to customers in USA

Pop-Up Wipers



| Part Number    | Sales Unit   |
|----------------|--------------|
| 365201-800-06* | 6 boxes/case |

Extremely durable, made with Hydrospun Technology. Reusable, long-lasting performance. Similar to red cloth shop towels but disposable. Compare to KC X80 red. Red, 9.5" x 16.5", 100 sheets in a box.



| Part Number    | Sales Unit    |
|----------------|---------------|
| 365201-700-10* | 10 boxes/case |

Durable, made with Hydrospun Technology. Excellent tear strength. Solvent resistant. Superior wipe-dry. Ideal for manufacturing, maintenance, transportation & hi-tech areas. Compare to KC Wypall® X70. White, 9' x 16". 100 sheets in a box.



| Part Number    | Sales Unit    |
|----------------|---------------|
| 365201-600-10* | 10 boxes/case |

Durable, low lint, made with Hydrospun Technology. Excellent shop towel replacement. Ideal for light manufacturing, general maintenance & transportation. Resistant to most solvents. Compare to Wypall® KC X60. White, 9" x 16.5". 125 sheets in a box.



| Part Number    | Sales Unit   |
|----------------|--------------|
| 365201-050-09* | 9 boxes/case |

Excellent general purpose wiper. Durable and strong. Packaging allows for wipers to be contained and portable. Can be assigned to worker to help control over usage. Compare to KC Wypall® X50. Blue. 16.5" x 9.5". 100 sheets in a box.



| Part Number    | Sales Unit   |
|----------------|--------------|
| 365212-050-08* | 8 boxes/case |

Excellent general purpose wiper. Durable and strong. Packaging allows for wipers to be contained and portable. Can be assigned to worker to help control over usage. Compare to KC Wypall® X50. White, 12.75" x 9.5". 275 sheets in a box.



| Part Number    | Sales Unit   |
|----------------|--------------|
| 365201-030-09* | 9 boxes/case |

Lightweight general purpose wiper. Soft enough to use as a personal wiper. Easily absorbs liquids, lubricants and oils. Compare to KC Wypall® L30. White. 9.8" x 16.4". 120 sheets in a box.



| Part Number    | Sales Unit    |
|----------------|---------------|
| 365201-010-18* | 18 boxes/case |

High quality, for everyday tasks. Compare to KC Wypall® L10. White, 2-ply. 9" x 10.25". 110 sheets in a box.



| Part Number** | Sales Unit   |
|---------------|--------------|
| 323014-000-08 | 8 boxes/case |

Standard wiper. Comparable to WypAll® X60 series of wipes. White, 9.5" x 16.5". 126 sheets in a box.

**\*\*Available for all customers**



| Part Number    | Sales Unit   |
|----------------|--------------|
| 365201-000-06* | 6 boxes/case |

Premier wiping cloth for low lint applications - creped finish, blue. Excellent for the final wipe in painting applications. Made with Hydro-Entangled binder free technology. Superior wipe-dry properties. Solvent resistant. Excellent tear strength. 16.75" x 9". 150 sheets in a box.





| Part Number** | Sales Unit   |
|---------------|--------------|
| 323015-000-08 | 8 boxes/case |

Economy wiper. Comparable to WypAll® L40 series of wipes. White, 9.2" x 16.5". 100 sheets in a box.

**\*\*Available for all customers**

Jumbo Roll / Small Roll Wipers



| Part Number    | Sales Unit   |
|----------------|--------------|
| 365202-800-03* | 3 rolls/case |

Heavy-duty absorbency and maintains strength in solvents & other liquids. Made with Hydrospun Technology. Durable wiper for extended cleaning performance. Reusable, long-lasting performance. High capacity Jumbo Roll helps control waste. Compare to KC Wypall® X-80 Jumbo Roll. Red, perforated. 12.5" x 12". 500 sheets on a roll.



| Part Number    | Sales Unit   |
|----------------|--------------|
| 365202-700-03* | 3 rolls/case |

Heavy-duty absorbency and maintains strength in solvents & other liquids. Made with Hydrospun Technology. Durable wiper for extended cleaning performance. Reusable, long-lasting performance. High capacity Jumbo Roll helps control waste. Compare to KC Wypall® X-70 Jumbo Roll. White, perforated. 12.6" x 13.1". 870 sheets on a roll.



| Part Number    | Sales Unit   |
|----------------|--------------|
| 365202-600-03* | 3 rolls/case |

Made with Hydrospun Technology. Medium-duty absorbency and strength in solvents and other liquids. Durable wiper for extended cleaning performance. Reusable, long-lasting performance. High capacity Jumbo Roll helps control waste. Compare to Wypall® X-60 Jumbo Roll. White, perforated. 12.5" x 13". 1100 sheets on a roll.



| Part Number    | Sales Unit   |
|----------------|--------------|
| 365202-040-03* | 3 rolls/case |

Excellent general purpose wiper. Durable and strong. High capacity Jumbo Roll helps control waste. Compare to Wypall® L-40 Jumbo Roll. White, perforated. 11.8" x 13.4". 750 sheets on a roll.



| Part Number | Description           |
|-------------|-----------------------|
| 365203-001* | Dispenser, wall mount |

Holds 1 Jumbo Roll. Mount on wall in work station. Blue. Metal.



| Part Number | Description      |
|-------------|------------------|
| 365203-002* | Dispenser, floor |

Holds 1 Jumbo Roll. Mobile floor mount for use in work station. Blue. Metal.

\*Available only to customers in USA

**Jumbo Roll / Small Roll Wipers (continued)**



| Part Number    | Sales Unit    |
|----------------|---------------|
| 365204-040-30* | 30 rolls/case |

Excellent general purpose wiper. Durable and strong. Small roll can be used in standard household paper towel dispenser. Perforated sheets. Blue. 11" x 9.4". 60 sheets on a roll.

SUPPLIES MAY BE LIMITED



| Part Number    | Sales Unit    |
|----------------|---------------|
| 365210-040-30* | 30 rolls/case |

Excellent general purpose wiper. Durable and strong. Small roll can be used in standard household paper towel dispenser. Perforated sheets. White. 11" x 9.4". 56 sheets on a roll.

SUPPLIES MAY BE LIMITED



| Part Number    | Sales Unit    |
|----------------|---------------|
| 365205-010-30* | 30 rolls/case |

Soft task white kitchen roll towel. General purpose. Fits all standard roll towel dispensers. Light weight. Rolls are individually wrapped. Premium quality for softness and absorption. White. 8.8" x 11" sheet size. 85 sheets per roll.

**Centerfeed Towels**



| Part Number | Sales Unit   |
|-------------|--------------|
| 365206-002* | 2 rolls/case |

Excellent general purpose wiper. Durable and strong. Centerfeed rolls. Fits standard center pull dispensers. White. 9" x 13". 200 sheets on a roll.



| Part Number    | Sales Unit   |
|----------------|--------------|
| 365207-040-08* | 8 rolls/case |

Excellent general purpose wiper. Durable and strong. Centerfeed rolls. Fits standard center pull dispensers. Blue, perforated. 9" x 15". 275 feet on a roll.



| Part Number | Sales Unit   |
|-------------|--------------|
| 365208-006* | 6 rolls/case |

100% cellulose. Excellent mechanics wipe. Centerfeed towel dispensing. Two-ply. A low lint light duty wiper. White, perforated. 7.6" x 12". 600 sheets on a roll.



| Part Number | Sales Unit   |
|-------------|--------------|
| 365344-006* | 6 rolls/case |

SCA Tork® White Advanced Centerfeed Towels. Perforated, highly absorbent towels dispense easily with one-at-a-time service for source reduction. Made from 100% recycled fiber. EcoLogo certified. Two-ply. 8.3" x 11.8". 610 sheets on a roll.



| Part Number | Description          |
|-------------|----------------------|
| 365209*     | Centerfeed dispenser |

Southern Soft® Center Pull Dispenser. Adjustable nozzle accepts a wide range of center pull towels. Easy loading; built-in level on back of dispenser for quicker mounting. All center feed towels listed above fit in this dispenser. Color is black/carbon translucent. 12.4" x 10" x 10.12".

**Flat Bulk Materials & Quarter Fold**



| Part Number    | Sales Unit       |
|----------------|------------------|
| 365211-040-18* | 18 packages/case |

Leading all-purpose wiper. Highly absorbent. Soft, cloth-like feel. Compare to KC Wypall® L40. White. ¼ fold. 12.5" x 13". 56 sheets in package.



| Part Number | Sales Unit              |
|-------------|-------------------------|
| 365213*     | Approximately 1700/case |

Leading grease and oil wiper. Excellent for any type of automotive clean-up. Soft and thick. Highly absorbent with grease and oil. White. Flat packed. 15" x 13".



| Part Number | Sales Unit              |
|-------------|-------------------------|
| 365215*     | Approximately 1650/case |

Smooth. Hydroknit irregulars. 25 lb. bulk. White or colors. 10" or 12" x 15".

**Woven Wiping Materials**



| Part Number | Sales Unit |
|-------------|------------|
| 365220-012* | 12/case    |

Cleans without harmful chemicals. Use wet or dry. Non-Abrasive. Non-Linting. Machine Washable. Blue. 16" x 16".



| Part Number | Sales Unit |
|-------------|------------|
| 365221-500* | 500/case   |

100% cotton shop towel. High absorption capability. Used for many grease and oil applications. A popular towel among mechanics. Red. 18" x 18".



| Part Number | Sales Unit   |
|-------------|--------------|
| 365222-025* | 25 lbs./case |

Mostly cotton hand towel. Will vary in size and color within each case. High absorbent and becomes even more absorbent after laundering. 14" x 24".



| Part Number | Sales Unit   |
|-------------|--------------|
| 365223-050* | 50 lbs./case |

Mostly cotton T-shirt towel. Excellent for cleaning, polishing and staining. Light to medium weight material. Soft and low linting. Towels compressed into heavy gauge polybags for shipping and storage. Un-washed material. Gray 12" x 18" to 24" x 24".



| Part Number | Sales Unit   |
|-------------|--------------|
| 365224-050* | 50 lbs./case |

Mostly cotton recycled knit T-shirt. Washed. Resists bleeding. Packaged in Spaceworks bag to reduce shipping costs. Inexpensive alternative to rental rags. Some may have screen printing. Shades of gray.

\* Available only to customers in USA

## Industrial Wiping Products

### Hand Towels



| Part Number    | Sales Unit    |
|----------------|---------------|
| 365340-150-16* | 16 packs/case |

C-Fold towels are soft, strong and absorbent. Made from 100% recycled fiber - EcoLogo Certified. White. 12¾" x 10⅞". 150/pack.



| Part Number    | Sales Unit    |
|----------------|---------------|
| 365352-250-16* | 16 packs/case |

Multi-fold Towels. Excellent drying capacity which reduces consumption. Each towel is dispensed individually for better hygiene. Ideal solution for a multitude of hand drying applications. White. 9.5" x 9". 250/pack.



| Part Number | Sales Unit    |
|-------------|---------------|
| 365353*     | 16 packs/case |

Southern Soft™ Multi-fold Dispenser. High capacity single serve dispensing. Adaptable to accommodate proprietary product size. Ideal solution for a multitude of hand drying applications. Accepts C-Fold, M-Fold and fits product size up to 10.125" in width. Includes a permanent turn-knob key that stays in the dispenser for low security locations and maintenance key for personnel. 15.89" H x 11.76" W x 5.34" D; built-in level on back of dispenser for quicker mounting.



| Part Number    | Sales Unit    |
|----------------|---------------|
| 365341-125-16* | 16 packs/case |

Premium Multi-Fold towel. White. 9½" x 9". 150/pack.



| Part Number    | Sales Unit    |
|----------------|---------------|
| 365342-250-16* | 16 packs/case |

Multi-Fold towels are soft, strong and absorbent. Made from 100% recycled fiber - EcoLogo Certified. White. 9½" x 9⅞". 250/pack.

### Drape Material/Fender Covers



| Part Number | Sales Unit     |
|-------------|----------------|
| 365226-072* | 72 sheets/case |

Treated material repels liquids. Economy drape material. Can be used as an outdoor cover, fender cover or floor/carpet protection. Blue/green. 6' x 41".

\* Available only to customers in USA

### Can Liners



| Part Number    | Description  |
|----------------|--|
| 365400-010-20* | 6 micron; 7-10 gallons, 24" x 24", 50/roll; 20 rolls/case  |
| 365400-012-20* | 6 micron; 12-16 gallons, 24" x 33", 50/roll; 20 rolls/case |
| 365400-020-20* | 10 micron; 30 gallons, 30" x 37", 50/roll; 10 rolls/case   |
| 365402-060-08* | 14 micron; 60 gallons; 38" x 60". 25/roll; 8 rolls/case    |

High density. High tensile strength. Very little stretch, Regular use. Natural.



| Part Number    | Description   |
|----------------|---|
| 365400-056-08* | 19 micron; 56 gallons; 43" x 48". 25/roll; 8 rolls/case |

High density. High tensile strength. Very little stretch, Extra heavy use. Black.



| Part Number    | Description  |
|----------------|--|
| 365401-045-01* | 1 mil; 40-45 gallons, 40" x 46", 20/roll, 5 rolls/case   |
| 365401-056-01* | 1 mil; 56 gallons, 43" x 47", 20/roll, 5 rolls/case      |
| 365401-033-01* | 1.2 mil; 33 gallons, 33" x 39", 20/roll, 10 rolls/case   |
| 365401-040-01* | 1.5 mil; 40-60 gallons, 40" x 46", 20/roll, 5 rolls/case |
| 365401-060-01* | 1.5 mil; 55 gallons, 38" x 58", 20/roll, 5 rolls/case    |
| 365401-062-01* | 2 mil; 55 gallons, 38" x 58", 10/roll, 10 rolls/case     |

Linear low density. Stretch, Extra heavy weight. Black.



| Part Number    | Description  |
|----------------|--|
| 365401-042-01* | 3 mil; 42 gallons, 33" x 48", 32/roll, 1 roll/case |
| 365401-055-01* | 3 mil; 55 gallons, 36" x 56", 15/roll, 1 roll/case |

Linear low density. Stretch, Premium heavy weight. Black.

\* Available only to customers in USA

## Floor Mats



**Note:** see Tools Section, page 9.04, for Crown Bar Stools.



### Crown Branded Mats

| Part Number | Size     |
|-------------|----------|
| 368200-001  | 2' x 3'  |
| 368200-002  | 3' x 5'  |
| 368200-003  | 4' x 6'  |
| 368200-004  | 3' x 10' |

Use the Crown branded mats to make a lasting impression to your customers. Static dissipative nylon yarn treated with StainStopper™ Technology. 100% nitrile rubber backing for increased slip and resistance. Certified High-Traction by the National Floor Safety Institute.

### Tough Rib Floor Mat

Dirt-trapping design is uniquely built for heavy-traffic and high soil areas. Extra coarse polypropylene fibers stand up to demanding use. Vinyl backing and borders. Can be cleaned by vacuuming, sweeping or hosing.

| Part Number | Size     | Color    |
|-------------|----------|----------|
| 368200-202  | 3' x 5'  | Charcoal |
| 368200-203  | 4' x 6'  | Charcoal |
| 368200-204  | 3' x 10' | Charcoal |



### Tire Tuff Royale High-Traffic Entrance Mat

Heavyweight floor mat designed for busy traffic areas – inside or out. Crush-resistant bi-level surface removes debris and moisture from passing shoes. Dual-fiber needle-punch mats dry quickly and resist staining and fading. Molded rubber backing for durability. Product contains 50% total recycled content.

| Part Number | Size    | Color |
|-------------|---------|-------|
| 368200-302  | 3' x 5' | Onyx  |

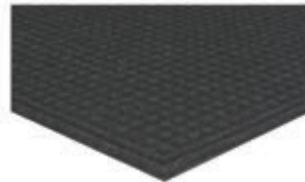

### Unifirst Great Impressions 2.0 Walk-Off Floor Mat

Heavy-duty, nylon-tufted mat with stay-put "hugger" backing. Dense rubber back helps mat stay in place, reduce flex and improve durability. Absorbent surfaces trap and hold up to a gallon of water per square yard. Heavier weight helps hold mat in place and reduce potential for "flip-ups".

| Part Number | Size     | Color |
|-------------|----------|-------|
| 368200-102  | 3' x 5'  | Grey  |
| 368200-103  | 4' x 6'  | Grey  |
| 368200-104  | 3' x 10' | Grey  |

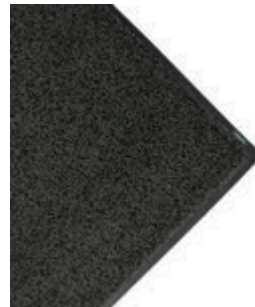



**Double Coated Tape**

| Part Number | Description                   |
|-------------|-------------------------------|
| 061000-002  | 5 mil, 1" x 36 yds - 3M #410M |

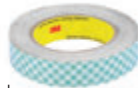

Utilizes a natural rubber adhesive system that offers good to excellent adhesion to many types of surfaces. Good holding power to a wide variety of materials. Low temp -40, high temp 200. Used on C5, SC45 & FC45 seats.

**Industrial Strapping Tape**

| Part Number | Description         |
|-------------|---------------------|
| 061000-003  | ½" x 180' - 3M #898 |



Reinforces corrugated and fiberboard boxes. Tackles heavy duty sealing and bundling. Recommended for "L" clip closures and "C" clip reinforcements. Excellent abrasion, moisture and scuff resistance. Clear polypropylene backing reinforced with glass yarn filaments. Synthetic rubber adhesive.

**3.5 Mil Transparent Polyester Film**

| Part Number | Description          |
|-------------|----------------------|
| 061000-004  | ¾" x 72 yds - 3M #57 |
| 061000-005  | 1" x 72 yds - 3M #57 |



Rubber adhesive, supplied on 3" core. Is suited for use as a coil cover, layer insulation and capacitor wrap where higher electrical strength is desirable. Color is yellow. Temperature class 266°F/ 130°C. Used on coil in contactor.

**Acetate Black Cloth Tape**

| Part Number | Description     |
|-------------|-----------------|
| 061000-006  | 7 mil, ¾" x 72' |



This tape offers excellent conformability in coil wrapping applications up to 105°C, 221°F. Acetate cloth tape offers excellent absorption of resins and varnishes. Printable. Used on coil in contactor.

**Black Fusion Tape**

| Part Number | Description                     |
|-------------|---------------------------------|
| 061000-015  | 1" x .020" x 30' - Amp 605980-2 |

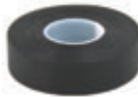

Fusion Tape is very easy to use and is ideal for wrapping electrical cable splices and terminations. It provides neat, trim, long-lasting insulation on a wide range of sizes, shapes, and materials. Applications are mostly electrical but Fusion Tape can be used in a wide variety of areas. This durable, black elastic tape has excellent electrical properties, water resistance, ozone resistance, and corrosion resistance at temperatures ranging from (-40°C) to 212°F, (100°C) continuous, and to 266°F (130°C) for short periods of time.

⚠️WARNING: Cancer and reproductive harm - [www.P65Warnings.ca.gov](http://www.P65Warnings.ca.gov)

**Electrical Tape**

| Part Number | Description     |
|-------------|-----------------|
| 380030-053  | 7 mil, ¾" x 60' |



Suitable for use at not more than 600 V and not more than 176°F (80°C). UL rated.

**Masking Tape\***

| Part Number | Description          | Sales Unit    |
|-------------|----------------------|---------------|
| 365406-024  | 5.1 mil, 2" x 60 yds | 24 rolls/case |
| 365407-016  | 5.1 mil, 3" x 60 yds | 16 rolls/case |



Industrial grade, general purpose masking tape for everyday needs. Used for masking, packaging, bundling and labeling. Off white.

**3M Super 33 Electrical Vinyl Tape**

| Part Number | Description     |
|-------------|-----------------|
| 323009      | 7 mil, ¾" x 66' |



Flame retardant, hot and cold weather resistant. Resists UV rays, abrasion, moisture, alkalis, acids and corrosion. Used as a primary insulation for wire cable splices up to 600V and for fixture and wire splices up to 1000V. Black.

**3M Super 88 Electrical Vinyl Tape**

| Part Number | Description       |
|-------------|-------------------|
| 323010      | 8.5 mil, ¾" x 66' |



Flame retardant, hot and cold weather resistant. Resists UV rays, moisture, alkalis, acids and corrosion. Superior cold weather handling and conformability. Extra thickness provides added electrical properties, quicker insulation build up and abrasion resistance. Black.

**Blue Painters Tape - Paint Shop Quality\***

| Part Number | Description            | Sales Unit |
|-------------|------------------------|------------|
| 365422-001  | 6.6 mil, .75" x 60 yds | 1 roll     |
| 365422-002  | 6.6 mil, 1.5" x 60 yds | 1 roll     |
| 365422-003  | 6.6 mil, 2" x 60 yds   | 1 roll     |



High performance painters tape. Clean removal, residue free. UV resistant up to 3 days. Resists bleed through. Aqua blue color.

**Blue Painters Tape\***

| Part Number | Description            | Sales Unit   |
|-------------|------------------------|--------------|
| 365408-024  | 5.6 mil, 1.5" x 60 yds | 6 rolls/case |



Low adhesion painters tape, acrylic-based adhesive. Not for body shop use. Removes cleanly from cured painted walls, trim, woodwork, glass and metal for up to 14 days without damage to the substrate even when exposed to direct or indirect sunlight.

**Duct Tape\***

| Part Number | Description        | Sales Unit   |
|-------------|--------------------|--------------|
| 365409-006  | 9 mil, 2" x 60 yds | 6 rolls/case |

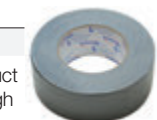

Has a strong poly-coated cloth backing. Excellent product to use to fix, repair, patch and seal. Sticks instantly in high and low temperatures. Silver. Individually wrapped.

**Carton Sealing Tape\***

| Part Number | Description           | Sales Unit    |
|-------------|-----------------------|---------------|
| 365410-024  | 1.9 mil, 3" x 110 yds | 24 rolls/case |
| 365411-036  | 1.9 mil, 2" x 110 yds | 36 rolls/case |



Sticks instantly to most surfaces. Conformable with smooth, easy release. Clear polypropylene with acrylic adhesive. Hot melt.

\* Available only to customers in USA

## Tape/Packaging

### Tape Dispenser\*

| Part Number | Description    |
|-------------|----------------|
| 365414      | Tape dispenser |

Holds 48mm x 110 yds (2" x 110 yds) roll. Adjustable tension brake.



### Tape Dispenser\*\*

| Part Number | Tape Width |
|-------------|------------|
| 351097-365  | 2"         |

Dispenses 2" tape. Adjustable spool accommodates large rolls. Blade guard protects hands and helps place tape onto box or envelope.



\*\*Available for all customers

### Shrink Wrap, Small Rolls\*

| Part Number | Description          | Sales Unit    |
|-------------|----------------------|---------------|
| 365405-018  | 90 gauge, 3" x 1000' | 18 rolls/case |

Polyethylene-cast stretch film. Exceptional load holding force. Superior cling and tear resistance in a wide variety of applications. **Faster and more economical to use than tape or strapping.** Includes handle.



### Shrink Wrap\*

| Part Number   | Description           | Sales Unit      |
|---------------|-----------------------|-----------------|
| 365405-004    | 80 gauge, 18" x 1500' | 4 rolls/case    |
| 365405-004-36 | 80 gauge, 18" x 1500' | 36 cases/pallet |

Polyethylene-cast stretch film. Exceptional load holding force. Superior cling and tear resistance in a wide variety of applications. **Faster and more economical to use than tape or strapping.**



### Quick Change Utility Knife and Blades\*

| Part Number | Description        | Sales Unit |
|-------------|--------------------|------------|
| 365412-006  | Utility Knife      | 6 knives   |
| 365413-100  | Replacement Blades | 100 blades |

Bi-metal Irwin blades stay sharp three times longer than ordinary blades and are unbreakable under normal working conditions. Smooth, durable, three-position slide exposes variable blade lengths and stands up to frequent use. Push-button offers easy access to interior blade storage. Fully retractable blade for safety. Built-in twine cutter. Includes one blade.



\*Available only to customers in USA

## Chemicals - Adhesives

Continued ▶

### Devcon Zip-Grip #4044 - Instant Adhesive

| Part Number | Sales Unit                      |
|-------------|---------------------------------|
| 061001-004  | Net wt 1/2 oz or 14 gram Bottle |

Suitable for bonding plastics, rubber, metals and dissimilar substrates. Adhesive fixes in seconds and provides a durable bond. Resistant to aging and weathering. Low viscosity for close fitting parts. Use on grommets and pedal pads.



### 3M Fastbond 30NF Adhesive

| Part Number | Sales Unit |
|-------------|------------|
| 061001-021  | Quart      |

Water-dispersed high-strength contact adhesive. Has high coverage, a long bonding range, and good heat resistance. Can be used to bond foamed plastics, plastic laminate, wood, plywood and wood veneer, and canvas to themselves and each other, as well as for post-forming operations. Non-flammable in the wet state. Neutral color. Used on foot pedals along with 061001-004. Also used on plastic grommets, seal strip extrusion like in the steering on SC and screws.



### Permabond HM128 Threadlocker

| Part Number | Sales Unit    |
|-------------|---------------|
| 061001-012  | 250 ml Bottle |

High strength adhesive for permanent assembly. Used for preventing vibration loosening of bolts, studs and cap screws. Replaces lock washers. Full cure at room temperature. Provides corrosion protection. Red in color.



### Hernon Instant Bond 113 - General Purpose

| Part Number | Sales Unit         |
|-------------|--------------------|
| 061001-007  | Net wt 1 oz Bottle |

This thin liquid is suitable for close tolerance bonding of a wide variety of materials. Used on self tapping screws.



### Super Bonder 498 Thermal Cycling Resistant - Instant Adhesive

| Part Number | Sales Unit         |
|-------------|--------------------|
| 061001-022  | Net wt 1 oz Bottle |

A medium viscosity, high temperature product for all metals, and most plastics and rubbers. Resists temperatures to 223 F continuous or up to 250 F intermittent. Used on thermal sensor on lift and drive motors.



## Chemicals - Adhesives



**3M Scotch Grip 1099 - Plastic Adhesive**  
**Part Number** | **Sales Unit**  
 061001-018 | Net wt 5 oz Tube

Excellent for bonding most vinyl extrusions and sheeting. Also bonds many fabrics and foams. Note: it may stain light colored, flexible vinyls; check before using. It is not recommended for bonding polyethylene or polypropylene. Meets MIL-A-13883B, Type I and MMM-A-189C, Class 2. Used on felt seals like on caster brake assembly on reach trucks.



**Jowat Laminating Adhesive**  
**Part Number** | **Sales Unit**  
 363600 | 9 lb jug

Laminating Adhesive - PVA Water based primer suitable for solid woods & high pressure laminates. Plastic film lamination / Primer for HPL. Used on rubber mats and grommets.



**3M Super Weatherstrip and Gasket Adhesive**  
**Part Number** | **Sales Unit**  
 061001-023 | Net wt 2 oz Tube

Yellow in color - A strong, flexible, rubbery adhesive that can withstand vibration and extreme temperature variations. It can be used to bond automotive weatherstripping and is a great adhesive for holding paper, cork, or rubber gaskets in place during installation. Used to glue wear strip on quick adjust casters.



**TRA-BOND 2143D**  
**Part Number** | **Sales Unit**  
 061001-020 | 6 cc

A medium viscosity adhesive recommended for industrial bonding and sealing applications where toughness, impact resistance, and superior mechanical properties are required. This two-part adhesive is easily mixed and cured at room temperature, and develops strong bonds to most clean, dry material surfaces including most metals, rigid plastics, glass, ceramics, leather, rubber, wood and concrete. Fully cured TRA-BOND 2143D bonds offer good low-temperature electrical, mechanical, and impact resistant properties, superior thermal shock resistance, low permeability to gases and vapors, good dimensional stability, and resistance to water, weather, oxygen and ozone, most petroleum products, mild acids and alkalis, and many other chemicals. Used on buttons and inserts like in the control handle.



**3M 1300 Rubber and Gasket Adhesive**  
**Part Number** | **Sales Unit**  
 061001-015 | Net wt 5 oz Tube

Yellow, versatile, heat resistant and adheres to metal and wood. A yellow, premium quality, versatile, brushable, heat resistant adhesive that develops strength rapidly. Has excellent adhesion to metal, bake enamel, wood, most plastics, and neoprene, reclaim, SBR, and butyl rubber. NOT for EPDM rubber. Used on felt seals, poly pads, and grommets.

## Chemicals - Retaining Compounds



**Turbo Fuse Instant Bonding Super Glue**  
**Part Number** | **Sales Unit**  
 061001-024 | Net wt 16 oz Bottle

Used on floormats. Comes with nozzle.

**Loctite Retaining Compounds**

| Part Number | Sales Unit | Description             |
|-------------|------------|-------------------------|
| 061004-027  | 0.5 ml     | Loctite 680 - Slip Fit  |
| 061004-021  | 250 ml     | Loctite 680 - Slip Fit  |
| 061004-022  | 50 ml      | Loctite 680 - Slip Fit  |
| 061004-025  | 0.5 ml     | Loctite 609 - Press Fit |
| 061004-009  | 10 ml      | Loctite 609 - Press Fit |



## Chemicals - Lubricants



**O-Ring and Valve Lubricant / Sealant**  
**Part Number** | **Sales Unit**  
 063002-020 | Net wt 5.3 oz Tube

Used as a lubricant for rubber and plastic o-rings, water softener and faucet valves, valve stems for potable water, aircraft vacuum systems, electronic and ignition systems. Used as a sealant in applications such as vacuum and pressure systems, equipment subject to washing and harsh environments, electrical service entrances and underground connections, and transformer gaskets and equipment enclosures. Used on Wave traction pod on torsion springs, FC4 compression spring on park brake switch, spacer in Wave clip pad.



**Nygel Contact Lubricant**  
**Part Number** | **Sales Unit**  
 127189-001 | 55 cc

Recommended lubricate for pins and sockets of GE EV100/200 and GenII products.



**G-n Metal Assembly Spray**  
**Part Number** | **Sales Unit**  
 063002-021 | Net wt 11 oz Can

Contains MoS<sub>2</sub>. Reduces galling and seizing. Use for cutting and shearing, drills and taps, metal fabricating, metal forming, press fitting, and running-in. Used on threaded shaft in servo control valve and spacer in height sensor.

**WARNING:** Reproductive Harm - [www.P65Warnings.ca.gov](http://www.P65Warnings.ca.gov)



**Permatex 133K Anti-Seize Lubricant**  
**Part Number** | **Sales Unit**  
 065005-003 | Net wt 8 oz Bottle

Heavy duty, formulated not to evaporate and harden, contains a heavy-duty blend of aluminum, copper and graphite. Designed to prevent galling, corrosion and seizing of mated parts. Withstands salt, corrosion and moisture. For use in assemblies up to 1600°F (871°C). Meets Mill Spec #907E.

## Chemicals - Insulator



### Silicone Dielectric

**Part Number** Sales Unit

063002-018 | Net wt 5.3 oz Tube

Insulator and bushing flashover protection. Good resistance against oxidation, moisture, and salt spray.



### Electrical Insulating Compound

**Part Number** Sales Unit

063002-019 | Net wt 5.3 oz Tube

Contains silicone. Provides moisture barrier. -70° F to 400° F. Applications: Electrical assemblies and terminals, cable connectors, battery terminals, and rubber and plastic o-rings.

## Chemicals - Heat Sink Compounds



### Silicone Heat Sink Compound

**Part Number** Sales Unit

063002-029 | Net wt 5.0 oz Tube

Thermal coupling of electrical/electronic devices to heat sinks. High thermal conductivity, low bleed, stable at high temperatures. White grease-like silicone heavily filled with heat-conductive metal oxides. Used on Access II & III traction control modules.



### Heat Sink Compound

**Part Number**

093983

Extra high-efficiency heat transfer compound. Used on heat sink assemblies, SCR panels, contactor panels and freezer heaters and limit switch assembly.

## Chemicals - Sealants



### Primer

**Part Number** Sales Unit

061004-002 | Net wt 4.5 oz Can

Loctite 7471 Locquic Primer T - Increases cure speed of Loctite anaerobic products. Especially recommended for applications with passive metals or inert surfaces and with large bond gaps. Use of activator is particularly recommended for cure conditions below 15° C.



### Primer

**Part Number** Sales Unit

061004-016 | Net wt 4.5 oz Can

Loctite 7649 Primer N - a solvent-based primer that features very long on-part life. Use to speed the cure of all Loctite Anaerobic Products and ensure proper cure on inactive metals. Ideal for cure conditions below room temperature.



### Liquid Gasket

**Part Number** Sales Unit

**Description**

|            |        |  |
|------------|--------|--|
| 061004-030 | 50 ml  | Loctite 518 (Gasket Eliminator-preferred sealant for aluminum flanges)                                   |
| 061004-015 | 300 ml |  |
| 323018     | 50 ml  | Loctite 515 (Medium strength, for machined metal flanges and gaps up to 0.25 mm; 30 minute fixture time) |
| 323018-001 | 300 ml |  |



### Security Sealant

**Part Number** Sales Unit Seal Type

065102-002 | 1 oz | Sentry Seal

Used to visually detect any movement in the adjustment of parts. Used on compression fittings, studs, nuts, parts and assemblies after they have been set to proper tension or position. Inspectors can visually detect any movement or tampering.

### Thread Locker

**Part Number** Sales Unit Description

|            |        |  |
|------------|--------|--|
| 061004-019 | 0.5 ml | Loctite 271 high strength                            |
| 061004-010 | 10 ml  | Loctite 271 high strength                            |
| 061004-026 | 0.5 ml | Loctite 242 medium strength                          |
| 061004-012 | 10 ml  | Loctite 242 medium strength                          |
| 061004-020 | 10 ml  | Loctite 222 low strength                             |
| 061004-018 | 250 ml | Nuts'n bolts 420 low strength                        |
| 061004-028 | 20 g   | Loctite 425 instant adhesive - assure surface curing |
| 323013     | 6 ml   | Medium strength blue                                 |



⚠️WARNING: Cancer and reproductive harm - www.P65Warnings.ca.gov

### Loctite Thread Sealant

**Part Number** Sales Unit Description

|            |        |   |
|------------|--------|---|
| 061004-011 | 50 ml  | Loctite 569 - high strength hydraulic sealant                 |
| 061004-023 | 50 ml  | Loctite 565 - PST pipe sealant                                |
| 061004-029 | 250 ml | Loctite 565 - PST pipe sealant                                |
| 061004-014 | 10 ml  | Nuts'n bolts 431 - fast cure, penetrating, preassembled parts |



### Gasket Maker

**Part Number** Sales Unit

363007-001 | 7 oz  
363007-003 | 3 oz

Permatex 85224 Powerbead The Right Stuff Instant Rubber Gasket Maker. The Right Stuff is blowout resistant and outperforms pre-cut gaskets. Protects against leaks caused by vibration and thermal expansion. Temp Range -75°F to 450°F continuous, 500°F intermittent and is Sensor-Safe.



### Loctite Flange Sealant

**Part Number** Sales Unit

805044 | 50 ml

Fast curing, provides resistance to low pressures immediately after assembly of flanges.



### Release Compound

**Part Number** Sales Unit

063002-033 | Net wt 5.3 oz Tube

Non-curing release agent. Applications: mold release agent, mold break-in, release agent for adhesives, release agent for plastic extruders, lubricant for plastics and elastomers.

## Chemicals - Sealant RTV



**Dow Corning 732/GE RTV Multi-Purpose Sealant**

| Part Number | Sales Unit               | Color |
|-------------|--------------------------|-------|
| 065031-001  | Net wt 10.3 oz Cartridge | Clear |
| 065031-002  | Net wt 3 oz tube         | Clear |
| 065031-003  | Net wt 3 oz tube         | Black |

Used for general sealing and bonding. One part nonslumping RTV paste. Tough, rubbery solid. Used on gaskets and terminal blocks.



**Loctite 598 High Performance Black RTV Silicone Gasket Maker**

| Part Number | Sales Unit          |
|-------------|---------------------|
| 323012      | Net wt 2.36 oz Tube |

Applications (horizontal or vertical): windshields, door frames, electrical connections, seams and roofs, vinyl tops, weatherstripping. General purpose, waterproof, flexible, RTV indoor/outdoor sealant. Seals, bonds, repairs metal, plastics, fabric vinyl. -80°F to 450°F.



**Dow Corning RTV Sealant 734 Flowable Sealant**

| Part Number | Sales Unit       |
|-------------|------------------|
| 065031-005  | Net wt 3 oz Tube |

100% silicone rubber. Self-leveling consistency. Forks flexible, long lasting seal. Extreme temperature performance. Applications: Making formed in place gaskets, filling minute cracks and crevices, sealing electrical equipment, sealing threads, coating fabrics and encapsulating small components. Used on heaters in freezer applications.



**Dow Corning 748 Non-Corrosive Sealant**

| Part Number | Sales Unit               | Color |
|-------------|--------------------------|-------|
| 065031-004  | Net wt 10.3 oz Cartridge | White |
| 065031-007  | Net wt 3.3 oz Tube       | White |

100% silicone rubber, safe for food contact, non-corrosive, -67° F to 350° F. Applications: Sealing corrosion-sensitive electrical & electronic equipment (electrical connections, wire entries, power and control cable connections, etc.), bonding and sealing food processing equipment. Formed-in-place gaskets for sensitive substrates. Used on modules and distribution panels.

**WARNING:** Cancer and reproductive harm - [www.P65Warnings.ca.gov](http://www.P65Warnings.ca.gov)



**Loctite 593 Superflex Black RTV Silicone**

| Part Number | Sales Unit          |
|-------------|---------------------|
| 323011      | Net wt 2.36 oz Tube |

Formulated to withstand extreme temperature cycling (-65°F to 450°F), UV light and ozone. Cannot be painted. Tack free in 30 minutes; full strength in 24 hours. General purpose, one-part silicone adhesive sealant. Cures at room temperature to form a tough rubber seal. Will not slump in overhead or vertical applications.

## Chemicals - Gasket Sealer



**Form-A-Gasket Sealant Liquid**

| Part Number | Sales Unit       |
|-------------|------------------|
| 065005-001  | Net wt 16 oz Can |

Resists hot and cold water, antifreeze, glycerin, fuel oil, kerosene, butane, and other fluids. Pressure resistant and leakproof to high octane gasoline, grease and lubricating oils. Applied as liquid changes to paste in a few seconds.



**Loctite Aerosol Hi-Tack Gasket Sealant 30526**

| Part Number | Sales Unit      |
|-------------|-----------------|
| 363009      | Net wt 9 oz Can |

Red-colored liquid sealant that holds gaskets in place during assembly. Seals and bonds rubber, cork, paper, felt, metal and asbestos gaskets. Sets quickly to a very tacky film. Suitable to 500°F (260°C). Contains no ozone-depleting compounds. Increased oil resistance. Non-corrosive.



**Loctite Hi-Tack Gasket Sealant 30525**

| Part Number | Sales Unit       |
|-------------|------------------|
| 065005-002  | Net wt 16 oz Can |

Red-colored, liquid sealant that holds gaskets in place during assembly. Seals and bonds rubber, cork, paper, felt, metal and asbestos gaskets. Sets quickly to a very tacky film.

## Repair Filler



**3M Bondo Body Filler**

| Part Number | Sales Unit |
|-------------|------------|
| MSC00001834 | 32 oz Tub  |

Shapes in minutes; formulated to be non shrinking, non reactive, permanently durable material for repairing metal, wood, steel, and plastic. Repairs dents, patches holes and leaks, and restores chips quickly.

**WARNING:** Cancer - [www.P65Warnings.ca.gov](http://www.P65Warnings.ca.gov)

# Filter Cross Reference



Oil & Transmission Filters  
364100-xxx



Fuel Filters  
364300-xxx



Hydraulic Filters  
364500-xxx



Fuel/Water Separators  
364600-xxx



Air Filters  
364200-xxx

| OE Number            | Crown Part Number |
|----------------------|-------------------|
| <b>AC Delco (AB)</b> |                   |
| 1240619-H2           | 364600-004        |
| 24-897               | 364500-016        |
| 550C                 | 364200-024        |
| 6732-71-6310         | 364600-004        |
| 6733-71-9110         | 364600-004        |
| A1033C               | 364200-027        |
| A1169C               | 364200-045        |
| A1172C               | 364700-003        |
| A120C                | 364200-049        |
| A133C                | 364200-049        |
| A1506C               | 364200-048        |
| A1518C               | 364200-043        |
| A1519C               | 364200-043        |
| A1604C               | 364700-002        |
| A170C                | 364200-049        |
| A170CW               | 364200-049        |
| A251C                | 364200-048        |
| A301CL               | 364200-046        |
| A3086C               | 364200-043        |
| A5004                | 364200-027        |
| A529C                | 364200-036        |
| A72C                 | 364200-048        |
| AC95                 | 364950-001        |
| C111                 | 364950-001        |
| C14                  | 364950-001        |
| C203                 | 364950-001        |
| C203X                | 364950-001        |
| C301                 | 364950-001        |
| C315                 | 364950-001        |
| C316                 | 364950-001        |
| CU3931062            | 364600-004        |
| CUFS1251             | 364600-004        |
| K14                  | 364950-001        |
| K15                  | 364950-001        |
| L14                  | 364950-001        |
| P203X                | 364950-001        |
| P204                 | 364950-001        |
| PC133K               | 364200-046        |
| PF1051               | 364100-008        |
| PF1056               | 364100-051        |
| PF1091               | 364500-009        |
| PF1097               | 364500-014        |
| PF1127               | 364100-046        |
| PF1180               | 364100-037        |
| PF1212               | 364100-017        |
| PF1218               | 364100-048        |
| PF1222               | 364100-008        |
| PF1230               | 364100-008        |
| PF1233               | 364100-041        |
| PF1237               | 364100-065        |
| PF1238               | 364100-044        |
| PF1250               | 364100-049        |
| PF13                 | 364100-020        |
| PF17                 | 364100-052        |
| PF20                 | 364100-050        |
| PF2057               | 364100-015        |
| PF2072               | 364500-011        |

| OE Number                       | Crown Part Number |
|---------------------------------|-------------------|
| PF2112                          | 364100-065        |
| PF2123                          | 364100-044        |
| PF2132                          | 364100-042        |
| PF2135                          | 364100-065        |
| PF2140                          | 364100-050        |
| PF2174                          | 364100-091        |
| PF2191                          | 364100-050        |
| PF2203                          | 364100-051        |
| PF2210                          | 364100-050        |
| PF28                            | 364100-052        |
| PF33                            | 364100-086        |
| PF41                            | 364100-044        |
| PF46                            | 364100-019        |
| PF48                            | 364100-031        |
| PF59                            | 364100-084        |
| PF881                           | 364500-009        |
| PF897                           | 364500-016        |
| PF9                             | 364100-047        |
| PF926                           | 364500-005        |
| PF933                           | 364100-086        |
| PF952                           | 364100-050        |
| PF960                           | 364100-045        |
| PM13-16                         | 364500-016        |
| T1068                           | 364300-017        |
| TP1001                          | 364300-024        |
| TP1067                          | 364300-027        |
| WF114                           | 364900-001        |
| X116                            | 364100-017        |
| X119                            | 364100-046        |
| X120                            | 364100-008        |
| X124                            | 364100-017        |
| X13                             | 364100-050        |
| X15                             | 364100-044        |
| X18                             | 364100-044        |
| X1K                             | 364100-020        |
| X20                             | 364100-044        |
| X46                             | 364100-008        |
| X7                              | 364100-050        |
| X72                             | 364100-075        |
| X9                              | 364100-044        |
| XD701                           | 364300-013        |
| <b>Allis Chalmers/Tusk (AC)</b> |                   |
| 0232578                         | 364100-005        |
| 0237000                         | 364100-005        |
| 0255191                         | 364100-026        |
| 0490015                         | 364200-046        |
| 0507826                         | 364950-001        |
| 0681546                         | 364900-001        |
| 0697635                         | 364900-001        |
| 1004421                         | 364200-018        |
| 10044213                        | 364200-018        |
| 1004652                         | 364200-018        |
| 10046522                        | 364200-018        |
| 10050698                        | 364300-003        |
| 10050789                        | 364300-003        |
| 1014120                         | 364100-038        |
| 1014121                         | 364100-026        |
| 1122177                         | 364100-026        |

| OE Number   | Crown Part Number |
|-------------|-------------------|
| 1140887     | 364200-018        |
| 1240483-H1  | 364300-024        |
| 1240621-H1  | 364500-015        |
| 190910-4    | 364950-001        |
| 20701K1230  | 364300-027        |
| 20801K1310  | 364300-024        |
| 20974077    | 364200-007        |
| 21P01K1390  | 364300-027        |
| 21U6-011330 | 364100-083        |
| 240760      | 364200-007        |
| 243163      | 364200-003        |
| 2447281     | 364200-046        |
| 246364      | 364200-007        |
| 246366      | 364200-007        |
| 247060      | 364200-007        |
| 2470607     | 364200-007        |
| 251397      | 364300-003        |
| 2513976     | 364300-003        |
| 252050      | 364300-003        |
| 3100276     | 364100-035        |
| 3193115     | 364950-001        |
| 344622      | 364200-046        |
| 4006995     | 364300-031        |
| 4048147     | 364950-001        |
| 4048417     | 364950-001        |
| 4059263     | 364100-016        |
| 4059343     | 364100-016        |
| 4060050     | 364300-003        |
| 40600504    | 364300-003        |
| 4135600-0   | 364100-050        |
| 4348147     | 364950-001        |
| 43905934    | 364100-016        |
| 4394407     | 364300-031        |
| 4490296     | 364300-003        |
| 4502498     | 364950-001        |
| 4502498-4   | 364950-001        |
| 4502499     | 364950-001        |
| 4502499-4   | 364950-001        |
| 4511629     | 364100-005        |
| 4512207     | 364100-016        |
| 4530702     | 364100-007        |
| 4789026     | 364200-003        |
| 4855745     | 364100-034        |
| 4900600     | 364100-016        |
| 4905902     | 364100-035        |
| 4906397     | 364100-035        |
| 4907794     | 364200-002        |
| 4907795     | 364200-003        |
| 4910328     | 364100-038        |
| 4910775     | 364100-005        |
| 4910810     | 364100-005        |
| 4915223     | 364100-036        |
| 4915238     | 364200-007        |
| 4915347     | 077145            |
| 4940471     | 364400-004        |
| 4941243     | 364500-003        |
| 4941711     | 364500-004        |
| 4942265     | 364100-001        |

| OE Number    | Crown Part Number |
|--------------|-------------------|
| 4942493      | 364100-001        |
| 4942494      | 364100-005        |
| 4942587      | 364200-003        |
| 4942657      | 364100-036        |
| 4945308      | 364400-004        |
| 4947751      | 364100-034        |
| 4948738      | 364100-050        |
| 4948955      | 364100-001        |
| 4949078      | 364200-002        |
| 4953804      | 380103-911        |
| 4966684      | 364100-020        |
| 4968759      | 364100-037        |
| 4996245      | 364200-003        |
| 4997958      | 364100-036        |
| 4999447      | 364100-035        |
| 507826       | 364950-001        |
| 540955       | 364950-001        |
| 545240       | 364950-001        |
| 600-211-5242 | 364100-086        |
| 600-311-8281 | 364300-031        |
| 600-311-8290 | 364300-031        |
| 600-311-8291 | 364300-031        |
| 600-311-8292 | 364300-031        |
| 6127-71-6090 | 364300-031        |
| 617966M      | 364950-001        |
| 62703506     | 364100-026        |
| 639050       | 364200-003        |
| 6732-71-6110 | 364300-027        |
| 6732-71-6111 | 364300-027        |
| 6732-71-6112 | 364300-027        |
| 67355-15140  | 364500-015        |
| 67365-15140  | 364500-015        |
| 6742-01-3790 | 364300-027        |
| 70239518     | 364200-002        |
| 70240760     | 364200-007        |
| 70243163     | 364200-003        |
| 70246364     | 364200-007        |
| 70246366     | 364200-007        |
| 70247060     | 364200-007        |
| 70639050     | 364200-003        |
| 72470607     | 364200-007        |
| 73100276     | 364100-035        |
| 74059263     | 364100-016        |
| 74059343     | 364100-016        |
| 74512207     | 364100-016        |
| 74530702     | 364100-007        |
| 74789026     | 364200-003        |
| 74855745     | 364100-034        |
| 74900600     | 364100-016        |
| 74905902     | 364100-035        |
| 74906397     | 364100-035        |
| 74907794     | 364200-002        |
| 74907795     | 364200-003        |
| 74915043     | 364300-003        |
| 74915238     | 364200-007        |
| 74915347     | 077145            |
| 74920158     | 364100-004        |
| 74941575     | 364200-002        |

⚠ WARNING: Cancer - [www.P65Warnings.ca.gov](http://www.P65Warnings.ca.gov)

Note: More crosses available; contact your dealer.

1.26 Crown One Source

Allis Chalmers/Tusk Continued ▶

# Filter Cross Reference

Allis Chalmers/Tusk Continued

| OE Number         | Crown Part Number |
|-------------------|-------------------|
| 74942265          | 364100-001        |
| 74942493          | 364100-001        |
| 74942587          | 364200-003        |
| 74943271          | 364200-002        |
| 74947751          | 364100-034        |
| 74947978          | 364100-007        |
| 74948955          | 364100-001        |
| 74949078          | 364200-002        |
| 74996245          | 364200-003        |
| 74996253          | 364200-002        |
| 74999447          | 364100-035        |
| 8760118           | 364100-041        |
| 8761948           | 364100-014        |
| 8763270           | 364100-037        |
| 8765210           | 364100-030        |
| 8767408           | 364200-014        |
| 8775054           | 364100-015        |
| 8775086           | 364200-026        |
| 8775575           | 364100-015        |
| 890321-H1         | 364200-046        |
| AX58828           | 364200-046        |
| B4844             | 364950-001        |
| CU3315843         | 364300-024        |
| CU3903640         | 364300-027        |
| CUFF5052          | 364300-027        |
| DE48147           | 364950-001        |
| DE65245           | 364100-016        |
| DHD222            | 364100-034        |
| DNP13D8627        | 364300-031        |
| DPF20             | 364100-037        |
| DPF2072           | 364500-011        |
| DPF56             | 364100-038        |
| DPF855            | 364100-035        |
| DPF881            | 364500-009        |
| DPF897            | 364500-016        |
| DPF939            | 364100-026        |
| DTP1067           | 364300-027        |
| <b>Baker (BK)</b> |                   |
| 0001160243        | 364300-027        |
| 0001174423        | 364300-027        |
| 0009830532        | 364300-029        |
| 0009830608        | 364100-034        |
| 0009830608V       | 364100-034        |
| 0009830621        | 364100-068        |
| 0009831415        | 364100-083        |
| 0009831615        | 364300-001        |
| 0009831617        | 364300-001        |
| 0009831625        | 364300-001        |
| 0009831625V       | 364300-001        |
| 0009831631        | 364200-018        |
| 0009831647        | 364300-001        |
| 0009831647V       | 364300-001        |
| 0009839012        | 364200-027        |
| 0009839012V       | 364200-027        |
| 068127177B        | 364300-001        |
| 101052            | 077145            |
| 101053            | 364100-007        |
| 101254            | 364100-016        |
| 1035337001        | 364300-003        |
| 1036728001        | 364100-038        |
| 104170            | 364200-003        |
| 118740            | 364100-022        |
| 126695            | 364100-007        |
| 135396            | 364100-022        |
| 151418            | 364300-001        |
| 400204            | 364100-005        |
| 7370              | 364950-001        |

| OE Number           | Crown Part Number |
|---------------------|-------------------|
| 737E1               | 364950-001        |
| 737J1               | 364200-009        |
| 737R1               | 364100-016        |
| 737W1               | 364100-016        |
| 9033AY1             | 364200-002        |
| 9033BM1             | 364200-003        |
| 9830606             | 364100-020        |
| 9830608             | 364100-034        |
| 9830621             | 364100-068        |
| 9831625             | 364300-001        |
| 9831631             | 364200-018        |
| 9839012             | 364200-027        |
| A0102               | 364100-020        |
| G151310232900       | 364300-009        |
| L0001160243         | 364300-027        |
| L0001174423         | 364300-027        |
| L0009830532         | 364300-029        |
| L0009830600N        | 364100-026        |
| L0009830607         | 364100-045        |
| L0009830621         | 364100-068        |
| L0009831415         | 364100-083        |
| L0009831615         | 364300-001        |
| L0009831617         | 364300-001        |
| L0009831647         | 364300-001        |
| L0160000002         | 364100-032        |
| L0312225208N        | 364100-026        |
| L1160024            | 364100-032        |
| L1174418            | 364100-032        |
| L68115561BN         | 364100-026        |
| L68115561N          | 364100-026        |
| L7995000510         | 364100-032        |
| LAE725006049        | 364100-044        |
| LF9454982           | 364500-009        |
| LFM8000435          | 364100-016        |
| LFM8102165          | 364100-044        |
| LH17W04             | 364100-032        |
| LPC202              | 364100-032        |
| LW94018             | 364100-032        |
| XVW074115562        | 364100-068        |
| <b>Baldwin (BW)</b> |                   |
| B113                | 364100-001        |
| B114                | 364100-045        |
| B114B               | 364100-045        |
| B120                | 364100-037        |
| B125                | 364100-028        |
| B132                | 364100-050        |
| B1400               | 364100-065        |
| B1402               | 364100-015        |
| B1405               | 364100-076        |
| B141                | 364100-047        |
| B141B               | 364100-047        |
| B1428               | 364100-048        |
| B1428B              | 364100-048        |
| B143                | 364100-009        |
| B1431               | 364100-067        |
| B1431B              | 364100-067        |
| B1432B              | 364100-084        |
| B159                | 364100-017        |
| B159B               | 364100-017        |
| B160                | 364100-031        |
| B161                | 364100-008        |
| B161-S              | 364100-008        |
| B161SB              | 364100-008        |
| B163                | 364100-020        |
| B173-S              | 364100-004        |
| B178                | 364100-022        |
| B2                  | 364100-005        |

| OE Number  | Crown Part Number |
|------------|-------------------|
| B227       | 364100-046        |
| B227B      | 364100-046        |
| B228       | 364100-044        |
| B228B      | 364100-044        |
| B233       | 364100-050        |
| B243       | 364100-039        |
| B247       | 364100-010        |
| B252       | 364100-034        |
| B253       | 364100-034        |
| B27        | 364100-012        |
| B31        | 364100-019        |
| B329       | 364100-049        |
| B33        | 364100-041        |
| B34        | 364100-023        |
| B35-S      | 364100-003        |
| B37        | 364100-011        |
| B421       | 364100-002        |
| B421B      | 364100-002        |
| B43        | 364100-024        |
| B43-S      | 364100-024        |
| B50        | 364100-016        |
| B7039      | 364100-091        |
| B7042      | 364100-013        |
| B7049      | 364100-014        |
| B7125      | 364100-028        |
| B7144      | 364100-033        |
| B7144B     | 364100-033        |
| B7152      | 364100-081        |
| B7177B     | 364100-083        |
| B7181      | 364100-025        |
| B7221      | 364100-080        |
| B7240      | 364100-066        |
| B7240B     | 364100-066        |
| B7243      | 364100-071        |
| B7290      | 364100-075        |
| B7306      | 152128            |
| B7333      | 364100-069        |
| B7446      | 364100-043        |
| B7449      | 364100-097        |
| B75        | 364100-051        |
| BA5374     | 364100-088        |
| BF1110     | 364300-015        |
| BF1110B    | 364300-015        |
| BF1210     | 364600-001        |
| BF1212B    | 364300-024        |
| BF1226B    | 364600-004        |
| BF1257     | 364300-005        |
| BF1257B    | 364300-005        |
| BF1258     | 364300-004        |
| BF1258B    | 364300-004        |
| BF1261     | 364300-013        |
| BF1261B    | 364300-013        |
| BF1280     | 364300-017        |
| BF1280B    | 364300-017        |
| BF1352-SPB | 364300-023        |
| BF1352-SPS | 364300-023        |
| BF5800     | 364300-002        |
| BF587      | 364300-001        |
| BF7534     | 364600-003        |
| BF7633     | 364300-007        |
| BF7673     | 364300-008        |
| BF7673B    | 364300-008        |
| BF7673D    | 364300-008        |
| BF7675D    | 364600-002        |
| BF7681     | 364300-032        |
| BF7681-D   | 364300-032        |
| BF7683     | 364300-010        |

| OE Number  | Crown Part Number |
|------------|-------------------|
| BF7683B    | 364300-010        |
| BF7760     | 364300-018        |
| BF7760B    | 364300-018        |
| BF7863     | 364300-011        |
| BF788B     | 364300-027        |
| BF788-PRO  | 364300-027        |
| BF7932     | 364300-016        |
| BF7957     | 364300-014        |
| BF825      | 364300-003        |
| BF836-K3   | 364300-034        |
| BF970      | 364300-031        |
| BF9894     | 364300-020        |
| BF995B     | 364300-033        |
| BPH13A     | 364100-012        |
| BPH8A      | 364100-005        |
| BT215      | 364100-038        |
| BT216      | 364100-026        |
| BT217      | 364100-064        |
| BT217B     | 364100-064        |
| BT223      | 364100-030        |
| BT230B     | 364500-016        |
| BT237      | 380103-911        |
| BT259      | 364100-052        |
| BT259B     | 364100-052        |
| BT260-10   | 364100-036        |
| BT274B     | 364100-086        |
| BT282-10   | 364100-035        |
| BT287-10   | 364100-029        |
| BT310      | 364100-006        |
| BT339B     | 364500-015        |
| BT344-S    | 364100-021        |
| BT351      | 364500-009        |
| BT351B     | 364500-009        |
| BT364      | 364100-007        |
| BT389-10   | 364500-014        |
| BT389-10B  | 364500-014        |
| BT40034    | 364100-092        |
| BT420      | 380030-180        |
| BT427      | 364100-032        |
| BT7237     | 364100-078        |
| BT7237-MPG | 364100-078        |
| BT7339B    | 364500-015        |
| BT839-10   | 077145            |
| BT8409     | 364400-001        |
| BT8428-MPF | 364100-040        |
| BT8439-MPG | 364400-003        |
| BT8449-10  | 364100-035        |
| BT8449-10B | 364100-035        |
| BT8472     | 364500-008        |
| BT8472B    | 364500-008        |
| BT8493     | 364400-002        |
| BT8833     | 364400-009        |
| BT8840-MPG | 364100-018        |
| BT8843-MPG | 364100-079        |
| BT9422     | 364500-013        |
| BW5086     | 364900-002        |
| BW5086B    | 364900-002        |
| P7308      | 364100-068        |
| PA10093    | 364200-053        |
| PA1636FN   | 364200-046        |
| PA1667-FN  | 364200-003        |
| PA1681-FN  | 364200-018        |
| PA1690-FN  | 364200-002        |
| PA1822-FN  | 364200-036        |
| PA1822-FNB | 364200-036        |
| PA1865-FN  | 364200-007        |
| PA2221     | 364200-004        |

SERVICE SUPPLIES

# Filter Cross Reference

Baldwin Continued

| OE Number         | Crown Part Number |
|-------------------|-------------------|
| PA2360-FN         | 364200-024        |
| PA2450            | 364700-001        |
| PA2575            | 364200-006        |
| PA2576            | 364200-016        |
| PA2725            | 364200-022        |
| PA2778-FN         | 364200-001        |
| PA2949-FN         | 364200-025        |
| PA3608-FN         | 364200-020        |
| PA3612            | 364200-027        |
| PA3651-FN         | 364200-028        |
| PA3792            | 364200-037        |
| PA3792B           | 364200-037        |
| PA3805-FN         | 364200-005        |
| PA3833            | 364200-011        |
| PA3989-FN         | 364200-041        |
| PA3989-FNB        | 364200-041        |
| PA4102            | 364700-002        |
| PA4113B           | 364200-043        |
| PA5582            | 364250-001        |
| PA5583            | 364200-032        |
| PA640             | 364200-009        |
| PA649             | 364200-049        |
| PA678             | 364200-048        |
| PF717             | 364300-009        |
| PF717B            | 364300-009        |
| PT381             | 364500-011        |
| PT716             | 380030-128        |
| PT752             | 364500-018        |
| PT83              | 364500-005        |
| PT83B             | 364500-005        |
| PT8515-MPGKIT     | 364400-008        |
| PT8515-MPGKITB    | 364400-008        |
| PT9167            | 364500-007        |
| PT9415-MPG KIT    | 364400-008        |
| PT9448            | 380030-114        |
| RS2863B           | 364200-045        |
| RS3528            | 364200-013        |
| RS3529            | 364200-017        |
| RS3542            | 364200-039        |
| RS3543            | 380030-009        |
| RS3544            | 364200-026        |
| RS3544B           | 364200-026        |
| RS3545            | 364200-031        |
| RS3549            | 364200-010        |
| RS3703            | 364200-015        |
| RS3703B           | 364200-015        |
| RS3704            | 364200-021        |
| RS3704B           | 364200-021        |
| RS3705            | 364200-042        |
| RS3715            | 364200-047        |
| RS3716            | 364200-014        |
| RS3744            | 364250-003        |
| RS3745            | 364250-004        |
| RS3747            | 364200-023        |
| RS3920            | 364200-040        |
| RS3920B           | 364200-040        |
| RS3940            | 364200-008        |
| RS3940B           | 364200-008        |
| RS3988B           | 364200-050        |
| RS4131            | 364200-019        |
| RS5745            | 364250-002        |
| RS5517            | 364200-051        |
| <b>Bosch (BQ)</b> |                   |
| 1-457-429-155     | 364950-001        |
| 1-457-429-156     | 364950-001        |
| 1-457-429-170     | 364950-001        |
| 1-457-429-172     | 364950-001        |

| OE Number         | Crown Part Number |
|-------------------|-------------------|
| 1-457-429-191     | 364950-001        |
| 1-457-429-240     | 364950-001        |
| 1-457-429-241     | 364950-001        |
| 1-457-429-619     | 364100-068        |
| 1-457-429-838     | 364200-027        |
| 1-457-429-951     | 364200-046        |
| 1-457-429-951-850 | 364200-046        |
| 1-457-431-225     | 364950-001        |
| 1-457-431-477     | 364950-001        |
| 1-457-431-478     | 364950-001        |
| 1-457-431-483     | 364950-001        |
| 1-457-434-103     | 364300-013        |
| 1-457-434-116     | 364300-013        |
| 1-457-434-118     | 364300-013        |
| 1-487-434-001     | 364100-088        |
| 1-487-434-005     | 364100-088        |
| 1-986-452-003     | 364100-020        |
| 1-986-452-006     | 364100-008        |
| 1-987-430-026     | 364200-046        |
| 26A               | 364200-046        |
| 3312              | 364100-008        |
| 4087HE            | 364950-001        |
| 4128HE            | 364950-001        |
| 451-001-001       | 364100-050        |
| 451-001-002       | 364100-050        |
| 451-001-002-850   | 364100-050        |
| 451-001-053       | 364100-050        |
| 451-001-053-850   | 364100-050        |
| 451-001-150       | 364100-050        |
| 451-102-001       | 364100-044        |
| 451-102-002       | 364100-020        |
| 451-102-056       | 364100-044        |
| 451-102-901       | 364100-044        |
| 451-103-003       | 364100-020        |
| 451-103-011       | 364100-050        |
| 451-103-011-310   | 364100-020        |
| 451-103-012       | 364100-020        |
| 451-103-014       | 364100-020        |
| 451-103-018       | 364100-050        |
| 451-103-018-850   | 364100-050        |
| 451-103-019       | 364100-044        |
| 451-103-021       | 364100-044        |
| 451-103-022       | 364100-050        |
| 451-103-025       | 364100-020        |
| 451-103-026       | 364100-044        |
| 451-103-027       | 364100-075        |
| 451-103-029       | 364100-050        |
| 451-103-034       | 364100-075        |
| 451-103-035       | 364100-075        |
| 451-103-036       | 364100-075        |
| 451-103-040       | 364100-050        |
| 451-103-041       | 364100-050        |
| 451-103-041-850   | 364100-050        |
| 451-103-043       | 364100-044        |
| 451-103-044       | 364100-050        |
| 451-103-048       | 364100-075        |
| 451-103-049       | 364100-044        |
| 451-103-050       | 364100-044        |
| 451-103-073       | 364100-075        |
| 451-103-080       | 364100-075        |
| 451-103-084       | 364100-044        |
| 451-103-096       | 364100-044        |
| 451-103-127       | 364100-044        |
| 451-103-133       | 364100-050        |
| 451-103-136       | 364100-050        |
| 451-103-141       | 364100-050        |
| 451-103-142       | 364100-020        |

| OE Number       | Crown Part Number |
|-----------------|-------------------|
| 451-103-166     | 364100-050        |
| 451-103-167     | 364100-050        |
| 451-103-171     | 364100-020        |
| 451-103-901     | 364100-044        |
| 451-103-902     | 364100-020        |
| 451-103-903     | 364100-050        |
| 451-104-005-850 | 364100-052        |
| 451-104-065     | 364100-045        |
| 451-163-019     | 364100-075        |
| 451-203-003     | 364100-050        |
| 451-203-009     | 364100-026        |
| 451-203-009-850 | 364100-026        |
| 451-203-010     | 364100-064        |
| 451-203-012     | 364100-045        |
| 451-203-061     | 364100-045        |
| 451-203-088     | 364100-045        |
| 451-203-154     | 364100-020        |
| 451-203-194     | 364100-026        |
| 72101           | 364100-020        |
| 72103           | 364100-020        |
| 72177           | 364100-017        |
| 8244H           | 364100-008        |
| 9-450-732-002   | 364100-020        |
| 9-450-732-005   | 364100-020        |
| 9-450-732-006   | 364100-050        |
| 9-450-732-010   | 364100-044        |
| 9-451-160-026   | 364200-046        |
| 9-457-240-870   | 364950-001        |
| 9-457-281-14050 | 364100-052        |
| 9-457-281-270   | 364100-050        |
| 9-457-282-170   | 364100-020        |
| 9-457-282-190   | 364100-075        |
| 9-457-282-440   | 364100-008        |
| 986-452-003     | 364100-050        |
| 986-452-006     | 364100-008        |
| 986-452-007     | 364100-046        |
| 986-452-008     | 364100-047        |
| 986-452-019     | 364100-075        |
| 986-452-028     | 364100-041        |
| 986-452-903     | 364100-020        |
| 986-452-917     | 364100-041        |
| 986-452-928     | 364100-041        |
| FJSJ24S3Z       | 364950-001        |
| O004            | 364100-041        |
| O133            | 364100-044        |
| O213            | 364100-044        |
| O219            | 364100-050        |
| O222            | 364100-050        |
| O231            | 364100-050        |
| O314            | 364100-020        |
| O317            | 364100-041        |
| O414            | 364950-001        |
| O626            | 364100-045        |
| OF124           | 364100-045        |
| OF152           | 364100-045        |
| OF160           | 364100-045        |
| OF162           | 364100-050        |
| P1150           | 364100-050        |
| P2003           | 364100-050        |
| P2006           | 364100-008        |
| P2007           | 364100-046        |
| P2008           | 364100-047        |
| P2028           | 364100-041        |
| P2056           | 364100-044        |
| P3010           | 364100-064        |
| P3012           | 364100-045        |
| P3029           | 364100-050        |

| OE Number                        | Crown Part Number |
|----------------------------------|-------------------|
| P3050                            | 364100-044        |
| P3084                            | 364100-044        |
| P3136                            | 364100-050        |
| P3141                            | 364100-050        |
| P3142                            | 364100-020        |
| P3154                            | 364100-020        |
| P3166                            | 364100-050        |
| P3167                            | 364100-050        |
| P3171                            | 364100-020        |
| P3194                            | 364100-026        |
| P4065                            | 364100-045        |
| P9170                            | 364950-001        |
| P9191                            | 364950-001        |
| P9241                            | 364950-001        |
| S9838                            | 364200-027        |
| <b>Caterpillar/Towmotor (CT)</b> |                   |
| 0068147                          | 364100-016        |
| 0068940                          | 364200-003        |
| 0313658                          | 364100-005        |
| 0314361                          | 364100-005        |
| 0329060                          | 364100-026        |
| 0342449                          | 364100-029        |
| 0349804                          | 364500-011        |
| 0363992                          | 364500-009        |
| 0643736                          | 364950-001        |
| 0663384                          | 364200-018        |
| 0665459                          | 364200-018        |
| 0665934                          | 077145            |
| 0668373                          | 364200-018        |
| 0684163                          | 364200-018        |
| 0687743                          | 364200-046        |
| 0689401                          | 364200-003        |
| 0694229                          | 364100-026        |
| 0902900                          | 364100-018        |
| 0938717                          | 364200-018        |
| 0971215                          | 364100-034        |
| 0971426                          | 364200-007        |
| 0971427                          | 364100-004        |
| 0971434                          | 364100-006        |
| 0971451                          | 364100-007        |
| 0971489                          | 364100-038        |
| 0972415                          | 364100-035        |
| 0972629                          | 364100-034        |
| 0972961                          | 364200-001        |
| 0973352                          | 380103-911        |
| 0973412                          | 364200-001        |
| 0973440                          | 364100-006        |
| 0973608                          | 364100-006        |
| 0973976                          | 364100-003        |
| 0973999                          | 364200-004        |
| 1014755                          | 364100-002        |
| 1015177                          | 364400-007        |
| 1015412                          | 364200-028        |
| 1015623                          | 364500-003        |
| 1032901                          | 364300-015        |
| 1033496                          | 364200-018        |
| 1033660                          | 364500-010        |
| 1036887                          | 074105            |
| 1037452                          | 364400-007        |
| 1037819                          | 364100-002        |
| 1038604                          | 364100-004        |
| 1039208                          | 364100-007        |
| 1039649                          | 364200-011        |
| 1039880                          | 364100-015        |
| 1041296                          | 364600-003        |
| 1041340                          | 364100-015        |
| 1041426                          | 364100-002        |

⚠ WARNING: Cancer - [www.P65Warnings.ca.gov](http://www.P65Warnings.ca.gov)

Note: More crosses available; contact your dealer.

Caterpillar/Towmotor Continued ▶



# Filter Cross Reference

Caterpillar/Towmotor Continued

| OE Number   | Crown Part Number |
|-------------|-------------------|
| 1041427     | 364100-015        |
| 1049852     | 077145            |
| 1049853     | 077145            |
| 1085330     | 364200-011        |
| 1106326     | 364200-026        |
| 1146853     | 364100-033        |
| 1146934     | 364100-006        |
| 1148105     | 364200-046        |
| 1157207     | 364400-007        |
| 1177394     | 077145            |
| 1194740     | 364500-012        |
| 1213661     | 364200-021        |
| 1232367     | 364200-039        |
| 1348726     | 364200-050        |
| 1383100     | 364300-032        |
| 1402334     | 364200-015        |
| 14049960    | 364200-027        |
| 1421339     | 364250-003        |
| 14483050    | 364500-010        |
| 1467172     | 364200-021        |
| 1467472     | 364200-021        |
| 1634465     | 364300-032        |
| 1767710     | 364100-075        |
| 1A3479      | 364300-031        |
| 1N3224      | 364500-016        |
| 1N4402      | 364100-013        |
| 1N4402H     | 364100-013        |
| 1P2299      | 364300-031        |
| 1R0711      | 364300-031        |
| 1R0713      | 364500-016        |
| 1R0714      | 364100-051        |
| 1R0734      | 364100-007        |
| 1R0740      | 364300-031        |
| 1R711       | 364300-031        |
| 1R713       | 364500-016        |
| 1R734       | 364100-007        |
| 1W2638      | 364500-016        |
| 1W8633      | 364300-031        |
| 216434      | 364200-024        |
| 226-6561    | 364300-024        |
| 226-6567    | 364900-001        |
| 231-0167    | 364200-039        |
| 231-0168    | 380030-009        |
| 26910875    | 364400-006        |
| 213007      | 364100-015        |
| 215044      | 364200-003        |
| 215120      | 077145            |
| 215488      | 364100-036        |
| 215999      | 364200-027        |
| 216318      | 364100-035        |
| 216434      | 364200-024        |
| 217724      | 364200-049        |
| 218660      | 364100-041        |
| 2W4246      | 380030-045        |
| 3003076800  | 364200-046        |
| 3003076801  | 364200-046        |
| 302877      | 364100-038        |
| 3063056800  | 364200-002        |
| 30A4000100  | 364100-015        |
| 30A4000101  | 364100-015        |
| 30A4000102  | 364100-015        |
| 30A4000103  | 364100-015        |
| 30A4000105  | 364100-015        |
| 30H3003710  | 364200-050        |
| 30H30-03710 | 364200-050        |
| 3113002300  | 364200-046        |
| 313658      | 364100-005        |

| OE Number   | Crown Part Number |
|-------------|-------------------|
| 314361      | 364100-005        |
| 329060      | 364100-026        |
| 32B40-00100 | 364100-033        |
| 32B40-10100 | 364100-033        |
| 32C40-00100 | 364100-006        |
| 3358        | 364300-027        |
| 342449      | 364100-029        |
| 34462-00300 | 364300-015        |
| 34462-11040 | 364600-003        |
| 34462-21040 | 364600-003        |
| 34730-04500 | 364200-046        |
| 349804      | 364500-011        |
| 349970      | 364100-029        |
| 361745      | 364300-003        |
| 363992      | 364500-009        |
| 364464      | 364100-005        |
| 371682      | 364100-038        |
| 386926      | 364100-021        |
| 3C2877      | 364100-038        |
| 3G6337      | 364500-012        |
| 3G6925      | 364500-012        |
| 3G6928      | 364100-021        |
| 3I0396      | 364200-018        |
| 3I0601      | 364500-005        |
| 3I0721      | 364500-016        |
| 3I0806      | 364200-018        |
| 3I0932      | 364200-018        |
| 3I1080      | 364300-001        |
| 3I1089      | 364100-052        |
| 3I1114      | 364100-003        |
| 3I1136      | 364100-050        |
| 3I1156      | 364950-001        |
| 3I1178      | 364300-017        |
| 3I1179      | 364300-027        |
| 3I1214      | 364100-020        |
| 3I1261      | 364100-050        |
| 3I1290      | 364900-001        |
| 3I1296      | 364100-026        |
| 3I1305      | 364300-024        |
| 3I1312      | 364300-024        |
| 3I1327      | 364500-016        |
| 3I1337      | 364100-051        |
| 3I1365      | 364300-024        |
| 3I1367      | 364300-024        |
| 3I1438      | 364500-005        |
| 3I1479      | 364100-065        |
| 3I1490      | 364100-020        |
| 3I1550      | 364200-045        |
| 3I1571      | 364200-048        |
| 3I1597      | 364500-009        |
| 3I1603      | 364100-006        |
| 3I1627      | 364100-050        |
| 3I1663      | 364500-014        |
| 3I2013      | 364200-045        |
| 3I2109      | 364100-049        |
| 3I2132      | 364300-017        |
| 3I2147      | 364200-021        |
| 3R0711      | 364300-031        |
| 4T6788      | 364100-029        |
| 4T7948      | 364500-012        |
| 50020152    | 364500-009        |
| 50021437    | 364200-039        |
| 50021439    | 380030-009        |
| 50237043    | 364200-040        |
| 50111722    | 364400-006        |
| 51209       | 364500-012        |
| 52034015    | 364200-050        |

| OE Number    | Crown Part Number |
|--------------|-------------------|
| 566B1405     | 364100-076        |
| 566B7177     | 364100-083        |
| 566B7290     | 364100-075        |
| 566BD7176    | 364100-074        |
| 566BF1212    | 364300-024        |
| 566BF1280    | 364300-017        |
| 566BF7681D   | 364300-032        |
| 566BF7760    | 364300-018        |
| 566BF788     | 364300-027        |
| 566BF970     | 364300-031        |
| 566BF995     | 364300-033        |
| 566BT38910   | 364500-014        |
| 566BT7237MPG | 364100-078        |
| 566BT8417    | 364500-012        |
| 566BT8454    | 364500-013        |
| 566BT8833    | 364400-009        |
| 566BW5073    | 364900-001        |
| 566BW5086    | 364900-002        |
| 566PA678     | 364200-048        |
| 566PT752     | 364500-018        |
| 566RS3705    | 364200-042        |
| 566RS3744    | 364250-003        |
| 566RS3745    | 364250-004        |
| 5882210072   | 364400-007        |
| 5A6717       | 364300-031        |
| 5C1791       | 364100-005        |
| 636082       | 364950-001        |
| 643736       | 364950-001        |
| 64375-91800  | 364100-004        |
| 65625-05300  | 364100-006        |
| 665459       | 364200-018        |
| 665934       | 077145            |
| 673217       | 364200-046        |
| 676987       | 364300-003        |
| 68147        | 364100-016        |
| 68148        | 364100-016        |
| 682994       | 364200-046        |
| 687743       | 364200-046        |
| 687744       | 364200-018        |
| 68940        | 364200-003        |
| 689401       | 364200-003        |
| 694229       | 364100-026        |
| 6A5162       | 364200-027        |
| 6A5162V      | 364200-027        |
| 6E0924       | 364500-012        |
| 6E0925       | 364500-012        |
| 6-E-924      | 364500-012        |
| 6E924        | 364500-012        |
| 6G924        | 364500-012        |
| 6I1450       | 364200-013        |
| 6-I-1451     | 364200-017        |
| 6I1451       | 364200-017        |
| 6L7440       | 364300-031        |
| 6-N-1009     | 077145            |
| 6N1009       | 077145            |
| 6N3784       | 364300-031        |
| 6V5875       | 364500-016        |
| 77-8190      | 364500-016        |
| 7N9027       | 364200-016        |
| 7N9028       | 364200-006        |
| 7W2326       | 380103-911        |
| 7W2327       | 364100-026        |
| 7W2328       | 364100-038        |
| 7W2692       | 364200-006        |
| 7W6221       | 364100-026        |
| 817003       | 364100-075        |
| 8J1600       | 364100-029        |

| OE Number  | Crown Part Number |
|------------|-------------------|
| 8L9765     | 364300-031        |
| 8N5504     | 364200-006        |
| 8N5504E    | 364200-006        |
| 8N5540     | 364200-006        |
| 8N9586     | 364500-016        |
| 8T7427     | 364500-016        |
| 902900     | 364100-018        |
| 9042000460 | 364100-003        |
| 9042501750 | 364100-002        |
| 9042508220 | 364300-006        |
| 9122000500 | 364100-004        |
| 9122010500 | 364100-004        |
| 9122407100 | 364400-007        |
| 9122407101 | 364400-007        |
| 9126100040 | 364200-028        |
| 9126100041 | 364200-028        |
| 9126100700 | 364200-002        |
| 9126106700 | 364200-028        |
| 9127503300 | 364500-003        |
| 9127503301 | 364500-003        |
| 9127513000 | 364500-003        |
| 9127513300 | 364500-003        |
| 9127513301 | 364500-003        |
| 9127605100 | 364100-004        |
| 9136100900 | 364200-011        |
| 9136100901 | 364200-011        |
| 9136103300 | 364200-011        |
| 9136110900 | 364200-011        |
| 9136113300 | 364200-011        |
| 9137503800 | 380030-114        |
| 9186101600 | 364200-041        |
| 9186105600 | 364200-018        |
| 9187501400 | 364500-010        |
| 9187505900 | 364500-010        |
| 9187511400 | 364500-010        |
| 91A6500611 | 364300-006        |
| 91B6100112 | 364200-021        |
| 91B6100912 | 364200-014        |
| 91E6100112 | 364200-010        |
| 91H2001870 | 364100-014        |
| 91K6101700 | 380030-009        |
| 91K6102112 | 380030-123        |
| 91K6102300 | 380030-009        |
| 93A2405500 | 380102-334        |
| 971215     | 364100-034        |
| 971216     | 364200-009        |
| 971217     | 364200-002        |
| 971251     | 364100-001        |
| 971289     | 364100-020        |
| 971309     | 364100-020        |
| 971357     | 364300-003        |
| 971426     | 364200-007        |
| 971427     | 364100-004        |
| 971434     | 364100-006        |
| 971441     | 364100-012        |
| 971451     | 364100-007        |
| 971489     | 364100-038        |
| 971630     | 364100-023        |
| 972415     | 364100-035        |
| 972422     | 364100-020        |
| 972545     | 364100-020        |
| 972597     | 364100-005        |
| 972629     | 364100-034        |
| 972703     | 364100-001        |
| 972961     | 364200-001        |
| 973356     | 364100-022        |
| 973412     | 364200-001        |

⚠ WARNING: Cancer - [www.P65Warnings.ca.gov](http://www.P65Warnings.ca.gov)

Note: More crosses available; contact your dealer.

Caterpillar/Towmotor Continued ▶

# Filter Cross Reference

Caterpillar/Towmotor Continued

SERVICE SUPPLIES

| OE Number  | Crown Part Number |
|------------|-------------------|
| 973440     | 364100-006        |
| 973608     | 364100-006        |
| 973976     | 364100-003        |
| 973999     | 364200-004        |
| 9G6926     | 364500-012        |
| 9L2646     | 364100-006        |
| 9L9054     | 364100-007        |
| 9L9200     | 364100-007        |
| 9N3717     | 364900-001        |
| 9N5570     | 364500-016        |
| 9-N-5570   | 364500-016        |
| 9N5680     | 364100-007        |
| 9N9586     | 364500-016        |
| 9T5664     | 364100-029        |
| 9Y0858     | 364100-051        |
| 9Y4431     | 364300-024        |
| 9Y4432     | 364300-024        |
| 9Y4450     | 364100-052        |
| 9Y4455     | 364100-003        |
| 9Y4464     | 364100-089        |
| 9Y4479     | 364100-026        |
| 9Y4480     | 364100-038        |
| 9Y4487     | 364100-020        |
| 9Y4492     | 364100-044        |
| 9Y4494     | 364100-006        |
| 9Y4499     | 364950-001        |
| 9Y4506     | 364100-050        |
| 9Y4507     | 364100-006        |
| 9Y4523     | 364500-005        |
| 9Y4532     | 364900-001        |
| 9Y6838     | 364200-046        |
| 9Y6841     | 364200-018        |
| 9Y858      | 364100-051        |
| A00000063  | 364200-010        |
| A00000313  | 364100-016        |
| A000001339 | 364100-079        |
| A000002445 | 364500-002        |
| A000002806 | 364200-008        |
| A000003164 | 364100-015        |
| A000003273 | 364200-011        |
| A000003458 | 364200-021        |
| A000005479 | 364100-011        |
| A000009231 | 364500-010        |
| A000009241 | 364500-015        |
| A000010905 | 364200-026        |
| A000013911 | 364300-002        |
| A000014210 | 364100-091        |
| A000014472 | 364950-001        |
| A000014514 | 364100-084        |
| A000014529 | 364200-043        |
| A000015358 | 364200-045        |
| A000015983 | 364200-050        |
| A000015985 | 364300-009        |
| A000015986 | 364200-047        |
| A000016007 | 364300-017        |
| A000016048 | 364300-024        |
| A000016115 | 364300-023        |
| A000019497 | 364200-050        |
| A000026444 | 380030-162        |
| A000026485 | 364400-006        |
| A000026486 | 364500-015        |
| A000026490 | 364400-006        |
| A000026588 | 380030-162        |
| A000026778 | 364300-032        |
| A000027284 | 364100-078        |
| A000029035 | 364200-048        |
| A000029038 | 364200-047        |

| OE Number                    | Crown Part Number |
|------------------------------|-------------------|
| A000029315                   | 364100-083        |
| A000031488                   | 364250-004        |
| A000031589                   | 364500-012        |
| A000031655                   | 364100-089        |
| A000036418                   | 364500-015        |
| A000037496                   | 364250-002        |
| A218649                      | 364100-012        |
| A218869                      | 364200-029        |
| A218870                      | 364200-030        |
| A643736                      | 364950-001        |
| D180237                      | 364200-006        |
| D490060                      | 364200-029        |
| D490416                      | 364200-030        |
| D501564                      | 364500-002        |
| E38874                       | 364100-020        |
| FW17                         | 364900-001        |
| FW9AFP                       | 364900-001        |
| GE924                        | 364500-012        |
| LE3ADG6926                   | 364500-012        |
| LM40DQ9804                   | 364500-011        |
| LM4ODQ9804                   | 364500-011        |
| MCF00321                     | 364100-021        |
| MD001445                     | 364100-047        |
| MD001450                     | 364100-004        |
| MD005445                     | 364100-004        |
| MD005450                     | 364100-004        |
| MD007095                     | 364100-004        |
| MD007360                     | 364100-004        |
| MD013661                     | 364100-013        |
| MD01445                      | 364100-047        |
| MD017410                     | 364100-004        |
| MD030795                     | 364100-004        |
| MD031805                     | 364100-004        |
| MD041462                     | 364100-004        |
| MD071462                     | 364100-006        |
| MD071462/A                   | 364100-004        |
| MD084693                     | 364100-015        |
| MD135707                     | 364100-015        |
| MD135737                     | 364100-015        |
| MD136466                     | 364100-002        |
| MD136780                     | 364100-015        |
| MD136790                     | 364100-046        |
| MD162326                     | 364100-006        |
| MD322508                     | 364100-015        |
| MD325714                     | 364100-015        |
| MD332687                     | 364100-002        |
| MD352626                     | 364100-002        |
| MD360935                     | 364100-015        |
| ME013661                     | 364100-013        |
| ME033617                     | 364200-046        |
| ME060219                     | 364200-046        |
| MM200570                     | 364200-007        |
| MM220900                     | 364600-003        |
| MM310860                     | 364100-004        |
| MM315200                     | 364100-004        |
| MM404981                     | 364200-007        |
| MM433093                     | 364300-009        |
| MO031805                     | 364100-015        |
| NA087002                     | 074105            |
| TM225L217                    | 364950-001        |
| <b>Champ/Luberfiner (CH)</b> |                   |
| HP1                          | 364100-034        |
| L296F                        | 364300-003        |
| LAF1275                      | 364200-002        |
| LAF1732                      | 364200-027        |
| LAF1820                      | 364200-006        |
| LAF222                       | 364200-003        |

| OE Number            | Crown Part Number |
|----------------------|-------------------|
| LAF234HD             | 364200-046        |
| LAF2745A             | 364200-007        |
| LAF4246              | 364200-022        |
| LAF4544              | 364200-026        |
| LAF5042              | 364200-020        |
| LAF8157              | 364200-025        |
| LAF8630              | 364200-001        |
| LFF3417              | 364300-017        |
| LFF3504              | 364300-001        |
| LFF3521              | 364300-027        |
| LFH4268              | 364500-009        |
| LFP2215              | 364100-020        |
| LFP3                 | 364950-001        |
| LFP780               | 364500-015        |
| LS165                | 364100-075        |
| LS99                 | 364100-075        |
| P3                   | 364950-001        |
| PH16                 | 364100-050        |
| PH227K               | 364100-001        |
| PH228                | 364100-020        |
| PH2808               | 364100-002        |
| PH2830               | 364100-037        |
| PH2835               | 364100-030        |
| PH2841               | 364100-011        |
| PH8862               | 364100-075        |
| <b>Chrysler (CY)</b> |                   |
| 1711791              | 364950-001        |
| 1711971              | 364950-001        |
| 3549957              | 364100-050        |
| 3685741              | 364100-050        |
| 3838011              | 364100-047        |
| 4026486              | 364100-047        |
| 4186165              | 364100-047        |
| 4417559              | 364100-050        |
| 4417560              | 364100-050        |
| 4419970              | 364100-080        |
| 44199700             | 364100-050        |
| 4429395              | 364500-015        |
| 4746914              | 364500-015        |
| 4761277              | 364500-015        |
| 5281090              | 364100-023        |
| 75221481             | 364100-050        |
| 83501080             | 364100-050        |
| HA302494             | 364950-001        |
| HA302495             | 364950-001        |
| HA302496             | 364950-001        |
| J0647345             | 364950-001        |
| J0909335             | 364950-001        |
| J8990041             | 364950-001        |
| J8990068             | 364950-001        |
| L1008                | 364100-050        |
| L19                  | 364100-050        |
| L19V                 | 364100-050        |
| L19X                 | 364100-050        |
| L31750               | 364100-052        |
| L319                 | 364100-020        |
| L530                 | 364100-020        |
| L6                   | 364950-001        |
| MD017440             | 364100-046        |
| MD136790             | 364100-046        |
| T0730077             | 364100-047        |
| T1365661             | 364100-020        |
| X3549957             | 364100-050        |
| <b>Clark (CL)</b>    |                   |
| 1232560              | 364300-009        |
| 1238466              | 364500-013        |
| 1243309              | 380030-180        |

| OE Number | Crown Part Number |
|-----------|-------------------|
| 1375550   | 364400-002        |
| 1582766   | 364300-031        |
| 15H999    | 364950-001        |
| 161WA258  | 364200-018        |
| 161WA357  | 364200-018        |
| 1624567   | 364200-018        |
| 1632441   | 364200-046        |
| 1670331   | 364200-007        |
| 176626    | 364950-001        |
| 1800976   | 364100-016        |
| 1801141   | 364100-034        |
| 1803991   | 364200-003        |
| 1803993   | 364200-002        |
| 1803995   | 364200-001        |
| 1804012   | 364200-016        |
| 1804038   | 077145            |
| 1804039   | 364100-029        |
| 1804041   | 364100-035        |
| 1804042   | 364100-013        |
| 1804045   | 364100-006        |
| 1804048   | 364100-016        |
| 1804051   | 364950-001        |
| 1804053   | 364100-034        |
| 1804054   | 364100-020        |
| 1804059   | 364100-050        |
| 1804065   | 364100-009        |
| 1804067   | 364100-006        |
| 1804073   | 364100-020        |
| 1804075   | 364100-021        |
| 1804081   | 364100-037        |
| 1804082   | 364100-013        |
| 1804083   | 364100-017        |
| 1804084   | 364100-001        |
| 1804085   | 364100-008        |
| 1804087   | 364100-003        |
| 1804088   | 364100-006        |
| 1804090   | 364100-044        |
| 1804107   | 077145            |
| 1804109   | 364200-020        |
| 1804110   | 364200-003        |
| 1804122   | 364300-015        |
| 1804129   | 364500-011        |
| 1804130   | 364500-009        |
| 1804133   | 364200-013        |
| 1804134   | 364200-017        |
| 1804139   | 364100-006        |
| 1804160   | 364400-004        |
| 1804169   | 364200-011        |
| 1804170   | 364100-014        |
| 1804185   | 364100-012        |
| 1804193   | 380030-164        |
| 1804194   | 364100-041        |
| 1804199   | 364100-035        |
| 1804200   | 364600-003        |
| 1804201   | 364200-002        |
| 1804223   | 364200-027        |
| 1804225   | 364200-003        |
| 1804290   | 364300-027        |
| 1804420   | 364100-032        |
| 1804424   | 364500-015        |
| 1805375   | 364200-021        |
| 1810884   | 364100-026        |
| 1810935   | 364100-038        |
| 1815007   | 364200-003        |
| 1815143   | 364100-076        |
| 1820450   | 364200-046        |
| 1902215   | 364200-018        |

**WARNING:** Cancer - [www.P65Warnings.ca.gov](http://www.P65Warnings.ca.gov)  
 Note: More crosses available; contact your dealer.

Clark Continued ▶

# Filter Cross Reference

Clark Continued

| OE Number | Crown Part Number |
|-----------|-------------------|
| 1917097   | 364100-018        |
| 1992366   | 364300-017        |
| 218869    | 364200-029        |
| 218870    | 364200-030        |
| 220070365 | 364500-011        |
| 2353816   | 364200-002        |
| 2373789   | 364200-004        |
| 2393449   | 364200-024        |
| 2399992   | 364200-004        |
| 244195    | 364100-079        |
| 247050    | 380030-046        |
| 2526831   | 364500-018        |
| 26561118  | 364300-001        |
| 2786616   | 364100-018        |
| 2791707   | 364200-010        |
| 2792962   | 364100-079        |
| 2817055   | 364100-062        |
| 2P0661    | 364100-016        |
| 3000063   | 364500-012        |
| 3000084   | 364500-011        |
| 3006350   | 364500-012        |
| 3040205   | 364500-011        |
| 3042173   | 364200-010        |
| 3042258   | 364500-012        |
| 3043684   | 364600-003        |
| 3127098   | 364950-001        |
| 3140102   | 364500-012        |
| 3143748   | 364500-012        |
| 3291008   | 364300-003        |
| 3338969   | 364300-003        |
| 3339643   | 364100-026        |
| 3340165   | 364100-037        |
| 3493878   | 364200-002        |
| 3575976   | 364900-001        |
| 3580376   | 364200-007        |
| 3653017   | 364500-009        |
| 3664917   | 364300-024        |
| 3734465   | 364100-038        |
| 3734468   | 364100-038        |
| 3736405   | 364100-044        |
| 3736833   | 364100-020        |
| 3777841   | 364100-026        |
| 3779228   | 364300-003        |
| 3779685   | 364100-007        |
| 3918206   | 364100-001        |
| 3974113   | 364100-006        |
| 3974113-B | 364100-046        |
| 3974896B  | 364100-050        |
| 3981922   | 364300-003        |
| 411975    | 364100-032        |
| 4127481   | 364100-032        |
| 4203691   | 364100-018        |
| 4307873   | 364600-003        |
| 4317841   | 364500-009        |
| 4318784   | 364500-009        |
| 4335192   | 364100-015        |
| 4352191   | 364100-022        |
| 4358425   | 364300-032        |
| 4367855   | 364100-008        |
| 448055    | 364400-007        |
| 448215    | 364500-010        |
| 449934    | 364400-006        |
| 563942    | 364200-046        |
| 604080    | 364950-001        |
| 604081    | 364950-001        |
| 6511766   | 364100-026        |
| 6515541   | 077145            |

| OE Number | Crown Part Number |
|-----------|-------------------|
| 6516722   | 077145            |
| 6518241   | 364200-048        |
| 6552449   | 364100-029        |
| 6591038   | 364100-029        |
| 6598361   | 364200-003        |
| 6599543   | 364100-018        |
| 6632745   | 364100-004        |
| 6644015   | 364100-047        |
| 6644210   | 364100-047        |
| 6647773   | 364300-005        |
| 6653968   | 364300-009        |
| 6661248   | 364100-018        |
| 6666333   | 364200-050        |
| 6666334   | 364200-015        |
| 6666376   | 380030-009        |
| 6667352   | 364300-005        |
| 6669547   | 364200-021        |
| 6673752   | 364200-047        |
| 6676705   | 364200-015        |
| 668788    | 364200-009        |
| 7000484   | 364200-028        |
| 7004639   | 364100-075        |
| 7024278   | 364900-001        |
| 739411010 | 364600-003        |
| 783407    | 364200-009        |
| 800038169 | 364900-001        |
| 8021179   | 364200-029        |
| 8021590   | 380030-009        |
| 8027765   | 364100-002        |
| 8048681   | 364100-078        |
| 852439    | 364950-001        |
| 854571    | 364950-001        |
| 870299    | 364500-009        |
| 880041    | 364950-001        |
| 886525    | 364200-003        |
| 889098    | 364200-002        |
| 892842    | 364100-036        |
| 897064    | 364200-007        |
| 900010    | 364900-001        |
| 904318    | 364300-009        |
| 907211    | 364300-003        |
| 907823    | 364100-005        |
| 909213    | 364100-004        |
| 910207    | 364100-020        |
| 910535    | 364100-026        |
| 910758    | 364100-052        |
| 910780    | 364100-073        |
| 913554    | 364500-015        |
| 913556    | 364300-017        |
| 913557    | 364300-027        |
| 918250    | 364100-015        |
| 918648    | 364100-002        |
| 920665    | 364600-003        |
| 922138    | 364100-003        |
| 923801    | 364200-010        |
| 924426    | 364950-001        |
| 925682    | 364500-003        |
| 925952    | 364100-002        |
| 926293    | 364100-015        |
| 928371    | 364300-032        |
| 928543    | 364100-003        |
| 928818    | 364500-015        |
| 928825    | 364300-017        |
| 928826    | 364300-027        |
| 930770    | 364100-015        |
| 931800    | 364100-006        |
| 932675    | 364100-002        |

| OE Number          | Crown Part Number |
|--------------------|-------------------|
| 932826             | 364100-058        |
| 942426             | 364950-001        |
| 944954             | 364200-046        |
| 948418             | 364900-001        |
| 949095             | 364300-031        |
| 949418             | 364900-001        |
| 949844             | 364300-003        |
| 960044             | 364900-001        |
| 960698             | 380103-911        |
| 960978             | 364900-001        |
| 961673             | 364900-001        |
| 978418             | 364900-001        |
| 990936             | 364100-016        |
| 990937             | 364100-005        |
| 992221             | 364100-034        |
| 994579             | 077145            |
| 995390             | 364100-080        |
| 997239             | 364200-003        |
| 997393             | 364100-029        |
| A10939             | 364950-001        |
| AF4066             | 364200-027        |
| AF843              | 364200-048        |
| CK2792962          | 364100-079        |
| DW65125035011      | 364300-024        |
| FAC1000350         | 364500-003        |
| FF5047             | 364600-004        |
| FF5052             | 364300-027        |
| FS1212             | 364300-024        |
| FS1251             | 364600-004        |
| FS1280             | 364300-017        |
| HCF11054           | 364200-018        |
| HCF11590           | 364200-018        |
| HCF14205           | 364200-018        |
| HCF15919           | 364200-018        |
| HF6107             | 364100-034        |
| HF6149             | 364500-011        |
| HF6160             | 364100-035        |
| HF6177             | 364500-009        |
| HF6351             | 364100-034        |
| HF7933             | 364100-035        |
| LF3310             | 364100-044        |
| LF3328             | 364100-051        |
| LF3342             | 364500-016        |
| LF3349             | 364500-015        |
| LF3536             | 364100-008        |
| LF3537             | 364100-008        |
| LF3552             | 364500-015        |
| LF3593             | 364100-051        |
| LF3653             | 364100-032        |
| LF4014             | 364100-044        |
| LF4056             | 364100-032        |
| LF701              | 364100-026        |
| MD135753           | 364100-015        |
| <b>Daewoo (DW)</b> |                   |
| 0750-131-061       | 364500-013        |
| 130-3539           | 364900-001        |
| 141106             | 364200-017        |
| 141107             | 364200-013        |
| 213624             | 364200-015        |
| 247052             | 364400-009        |
| 2474-9060          | 364300-024        |
| 3446221040         | 364600-003        |
| 400508-00064       | 364100-093        |
| 4720292            | 364200-013        |
| 474-00026          | 364200-047        |
| 5055105009         | 364500-015        |
| 5125035011         | 364300-024        |

| OE Number      | Crown Part Number |
|----------------|-------------------|
| 65.12503-5011  | 364300-024        |
| 65.05510-5009  | 364100-025        |
| 65.05510-5015  | 364100-025        |
| 65.05510-5021  | 364100-025        |
| 65.12501-7028B | 364600-003        |
| 65.12503-5011  | 364300-024        |
| 65.12503-5016  | 364300-004        |
| 65.12515-5006  | 364300-015        |
| 65.12515-5008  | 364600-003        |
| 65.21501-7028B | 364600-003        |
| 7W2327         | 364100-026        |
| 9912-15115     | 364900-001        |
| A000037496     | 364250-002        |
| A138746        | 364500-013        |
| A213624        | 364200-015        |
| A213625        | 364200-010        |
| A213938        | A213938           |
| A213939        | A213939           |
| A218226        | 364100-065        |
| A218649        | 364100-012        |
| A218869        | 364200-029        |
| A218870        | 364200-030        |
| A232028        | 364100-003        |
| A251025        | 364100-026        |
| A273017        | 364400-004        |
| A273757        | 364100-025        |
| A273813        | 364600-003        |
| A293020        | 364600-003        |
| D140182        | D140182           |
| D141100        | 364100-013        |
| D141106        | 364200-017        |
| D141107        | 364200-013        |
| D141121        | 364200-017        |
| D160552A       | 364100-026        |
| D161308        | 364300-001        |
| D164821        | 364500-011        |
| D180237        | 364200-006        |
| D180238        | 364200-016        |
| D470244        | 364200-015        |
| D470245        | 364200-010        |
| D490060        | 364200-029        |
| D490416        | 364200-030        |
| D501564        | 364500-002        |
| EAF5067        | 364200-045        |
| G042544        | 364200-047        |
| G110119        | 364200-045        |
| K1019575       | 364400-001        |
| P164266        | 364500-018        |
| P171533        | 364500-019        |
| P173738        | 364100-079        |
| P181045        | 364200-046        |
| P527484        | 364200-045        |
| P528231        | 364200-048        |
| P548963        | 364200-043        |
| P550371        | 364100-091        |
| P550399        | 364300-032        |
| P550434        | 364300-032        |
| P550440        | 364300-027        |
| P550505        | 364100-084        |
| P550520        | 364100-078        |
| P550660        | 364300-023        |
| P551329        | 364300-017        |
| P551429        | 364300-032        |
| P552126        | 364900-002        |
| P552203        | 364300-018        |
| P555010        | 364300-024        |
| P555570        | 364500-016        |

SERVICE SUPPLIES

**WARNING:** Cancer - [www.P65Warnings.ca.gov](http://www.P65Warnings.ca.gov)  
**Note:** More crosses available; contact your dealer.

Daewoo Continued ▶

# Filter Cross Reference

Deawoo Continued

| OE Number             | Crown Part Number |
|-----------------------|-------------------|
| P557440               | 364300-031        |
| P558000               | 364300-024        |
| P560971               | 364400-008        |
| P822686               | 364200-047        |
| <b>Donaldson (DN)</b> |                   |
| 21915-99003           | 364900-001        |
| 21915-990032          | 364900-001        |
| A052526               | 364200-002        |
| A065007               | 364200-003        |
| A100017               | 364200-046        |
| AO80031               | 364200-018        |
| CFP554073             | 364900-001        |
| DU770CT               | 364200-018        |
| DU770T                | 364200-018        |
| DU8792                | 364200-046        |
| EAF5067               | 364200-045        |
| ELF7680               | 364100-007        |
| EPG110119             | 364200-045        |
| EPG110120             | 364200-045        |
| EPG110346             | 364200-045        |
| FFP170212             | 364300-024        |
| FFP170915             | 364300-002        |
| FFP550439             | 364300-017        |
| FFP550440             | 364300-027        |
| FFP555001             | 364300-024        |
| FFP555010             | 364300-024        |
| FFP558000             | 364300-024        |
| FFP558020             | 364300-024        |
| FHG080147             | 364200-036        |
| FHG080193             | 364200-018        |
| FHG080286             | 364200-018        |
| FHG080297             | 364200-018        |
| FHG080318             | 364200-018        |
| FHG080491             | 364200-036        |
| FL915-99003           | 364900-001        |
| FPG042544             | 364200-047        |
| FPG042546             | 364200-047        |
| FPG042575             | 364200-047        |
| FPG057511             | 364200-021        |
| FPG057512             | 364200-021        |
| FPG057513             | 364200-021        |
| FPG057514             | 364200-021        |
| FPG065011             | 364200-015        |
| FPG065411             | 364200-015        |
| FPG065424             | 364200-015        |
| FPG065432             | 364200-015        |
| FPG065433             | 364200-015        |
| FPG065459             | 364200-015        |
| FPG065530             | 364200-015        |
| FPG070006             | 364200-039        |
| FPG070009             | 364200-039        |
| FPG070017             | 364200-039        |
| FPG070018             | 364200-039        |
| FPG070019             | 364200-039        |
| FPG070020             | 364200-039        |
| FPG070059             | 364200-039        |
| FPG070060             | 364200-039        |
| FW9B                  | 364900-001        |
| FWA060062             | 364200-018        |
| FWA080022             | 364200-018        |
| FWA080027             | 364200-018        |
| FWA080031             | 364200-018        |
| FWA080046             | 364200-018        |
| FWA100002             | 364200-046        |
| FWA100012             | 364200-046        |
| FWA100021             | 364200-046        |
| FWA100045             | 364200-046        |

| OE Number | Crown Part Number |
|-----------|-------------------|
| FWA100049 | 364200-046        |
| FWA100051 | 364200-046        |
| FWA100064 | 364200-046        |
| FWA100065 | 364200-046        |
| FWF080061 | 364200-018        |
| FWG080013 | 364200-018        |
| FWG080023 | 364200-018        |
| FWG080026 | 364200-018        |
| FWG080028 | 364200-018        |
| FWG080038 | 364200-018        |
| FWG080044 | 364200-036        |
| FWG080045 | 364200-018        |
| FWG080057 | 364200-018        |
| FWG080070 | 364200-018        |
| FWG080073 | 364200-018        |
| FWG080074 | 364200-018        |
| FWG080085 | 364200-018        |
| FWG080089 | 364200-018        |
| FWG080097 | 364200-018        |
| FWG080117 | 364200-018        |
| FWG080119 | 364200-018        |
| FWG080124 | 364200-018        |
| FWG080141 | 364200-018        |
| FWG080146 | 364200-018        |
| FWG080196 | 364200-018        |
| FWG080380 | 364200-018        |
| FWG100000 | 364200-046        |
| FWG100003 | 364200-046        |
| FWG100007 | 364200-046        |
| FWG100011 | 364200-046        |
| FWG100017 | 364200-046        |
| FWG100018 | 364200-046        |
| FWG100038 | 364200-046        |
| FWG100054 | 364200-046        |
| FWG100056 | 364200-046        |
| FWG100059 | 364200-046        |
| FWG100072 | 364200-046        |
| FWG100086 | 364200-046        |
| G042544   | 364200-047        |
| G042575   | 364200-047        |
| G057511   | 364200-021        |
| G057512   | 364200-021        |
| G057513   | 364200-021        |
| G057514   | 364200-021        |
| G065424   | 364200-015        |
| G065432   | 364200-015        |
| G065433   | 364200-015        |
| G070006   | 364200-039        |
| G070009   | 364200-039        |
| G070017   | 364200-039        |
| G070018   | 364200-039        |
| G070019   | 364200-039        |
| G070020   | 364200-039        |
| G070059   | 364200-039        |
| G070060   | 364200-039        |
| G070125   | 364200-039        |
| G110119   | 364200-045        |
| G110120   | 364200-045        |
| G110342   | 364200-045        |
| G110346   | 364200-045        |
| HFP552297 | 364100-086        |
| KAX000512 | 364200-018        |
| KAX002049 | 364200-018        |
| KAX002371 | 364200-046        |
| KAX002401 | 364200-046        |
| KAX002420 | 364200-018        |
| KAX002662 | 364200-018        |

| OE Number | Crown Part Number |
|-----------|-------------------|
| LFP170007 | 364100-051        |
| LFP170008 | 364100-005        |
| LFP170025 | 364100-012        |
| LFP170050 | 364100-016        |
| LFP170570 | 364500-016        |
| LFP550020 | 364100-052        |
| LFP550047 | 364100-024        |
| LFP550051 | 364100-003        |
| LFP550173 | 364100-004        |
| LFP550203 | 364950-001        |
| LFP550227 | 364100-001        |
| LFP552518 | 364100-050        |
| LFP554403 | 364100-026        |
| LFP555570 | 364500-016        |
| LFP556007 | 364100-051        |
| P101146   | 364200-018        |
| P101271   | 364200-018        |
| P105368   | 364200-036        |
| P107435   | 364200-018        |
| P107668   | 364200-036        |
| P107868   | 364200-036        |
| P108160   | 364200-018        |
| P112329   | 364200-018        |
| P115155   | 364200-018        |
| P118652   | 364200-036        |
| P124154   | 364200-018        |
| P124173   | 364200-036        |
| P124178   | 364200-018        |
| P126040   | 364200-018        |
| P132976   | 364200-018        |
| P133653   | 364200-018        |
| P134468   | 364200-006        |
| P151145   | 364200-036        |
| P154632   | 364200-036        |
| P162017   | 364500-005        |
| P162591   | 364500-018        |
| P163067   | 364100-035        |
| P164266   | 364500-018        |
| P164375   | 364100-018        |
| P164376   | 364100-018        |
| P165243   | 364100-035        |
| P166508   | 364500-016        |
| P168011   | 364100-024        |
| P168090   | 364100-026        |
| P168365   | 364100-051        |
| P170212   | 364300-024        |
| P170841   | 364300-034        |
| P171533   | 364500-019        |
| P171534   | 364500-007        |
| P171606   | 364500-008        |
| P172527   | 364100-023        |
| P172539   | 364100-022        |
| P172540   | 364100-022        |
| P172553   | 364100-024        |
| P172654   | 364300-017        |
| P172655   | 364300-027        |
| P172900   | 364500-014        |
| P172931   | 364900-001        |
| P172932   | 364900-001        |
| P172933   | 364900-001        |
| P173738   | 364100-079        |
| P174478   | 364100-079        |
| P181045   | 364200-046        |
| P181054   | 364200-018        |
| P181060   | 364200-024        |
| P181062   | 364200-024        |
| P183215   | 364200-018        |

| OE Number | Crown Part Number |
|-----------|-------------------|
| P184196   | 364200-018        |
| P185067   | 364200-045        |
| P502007   | 364100-015        |
| P502015   | 364100-041        |
| P502019   | 364100-041        |
| P502022   | 364100-044        |
| P502049   | 364100-046        |
| P502051   | 364100-008        |
| P502062   | 364100-065        |
| P502067   | 364100-065        |
| P502069   | 364100-014        |
| P502071   | 364100-046        |
| P502080   | 364100-033        |
| P502143   | 364300-015        |
| P502161   | 364300-009        |
| P502504   | 364300-025        |
| P522606   | 364200-045        |
| P526873   | 364200-009        |
| P527484   | 364200-045        |
| P528231   | 364200-048        |
| P529493   | 364200-045        |
| P530300   | 364200-045        |
| P532410   | 364200-010        |
| P533109   | 364200-013        |
| P533110   | 364200-017        |
| P534885   | 364200-023        |
| P535337   | 364200-005        |
| P537377   | 364200-004        |
| P537876   | 364250-003        |
| P537877   | 364250-004        |
| P539464   | 364200-049        |
| P539507   | 364200-015        |
| P542711   | 380030-009        |
| P544098   | 364200-019        |
| P546641   | 364200-011        |
| P548963   | 364200-043        |
| P550003   | 364300-034        |
| P550020   | 364100-052        |
| P550047   | 364100-024        |
| P550072   | 364100-023        |
| P550083   | 364100-065        |
| P550095   | 364100-020        |
| P550111   | 364950-001        |
| P550016   | 364300-033        |
| P550148   | 364500-009        |
| P550162   | 364100-046        |
| P550208   | 364100-050        |
| P550222   | 364100-034        |
| P550243   | 364100-051        |
| P550248   | 364600-004        |
| P550335   | 364100-030        |
| P550351   | 364300-008        |
| P550371   | 364100-091        |
| P550390   | 364600-003        |
| P550399   | 364300-032        |
| P550422   | 364100-033        |
| P550434   | 364300-032        |
| P550438   | 364300-017        |
| P550439   | 364300-017        |
| P550440   | 364300-027        |
| P550486   | 364500-012        |
| P550505   | 364100-084        |
| P550520   | 364100-078        |
| P550660   | 364300-023        |
| P550690   | 364300-005        |
| P550726   | 364100-046        |
| P550771   | 364300-032        |

**WARNING:** Cancer - [www.P65Warnings.ca.gov](http://www.P65Warnings.ca.gov)  
 Note: More crosses available; contact your dealer.

Donaldson Continued ▶

# Filter Cross Reference

Donaldson Continued

| OE Number | Crown Part Number |
|-----------|-------------------|
| P550882   | 364100-020        |
| P550929   | 364300-023        |
| P550939   | 364100-081        |
| P550963   | 364100-023        |
| P550964   | 364100-048        |
| P550965   | 364100-049        |
| P551001   | 364300-004        |
| P551019   | 364100-083        |
| P551176   | 364300-017        |
| P551215   | 364500-011        |
| P551241   | 364500-014        |
| P551251   | 364100-050        |
| P551268   | 364100-081        |
| P551307   | 364100-019        |
| P551313   | 364300-007        |
| P551324   | 364100-021        |
| P551327   | 364100-034        |
| P551329   | 364300-017        |
| P551352   | 364100-028        |
| P551740   | 364300-007        |
| P552060   | 364900-001        |
| P552073   | 364900-001        |
| P552126   | 364900-002        |
| P552203   | 364300-018        |
| P552224   | 364100-074        |
| P552297   | 364100-086        |
| P552518   | 364100-050        |
| P552849   | 364100-008        |
| P554073   | 364900-001        |
| P554403   | 364100-026        |
| P554408   | 364100-038        |
| P554685   | 364900-001        |
| P554770   | 364100-039        |
| P555010   | 364300-024        |
| P555461   | 364500-005        |
| P555570   | 364500-016        |
| P555961   | 364500-005        |
| P556005   | 364100-036        |
| P556007   | 364100-051        |
| P556245   | 364300-003        |
| P557440   | 364300-031        |
| P557780   | 364100-045        |
| P558000   | 364300-024        |
| P558615   | 364500-015        |
| P558616   | 364100-032        |
| P560971   | 364400-008        |
| P600501   | 364200-019        |
| P606948   | 364200-025        |
| P606953   | 364200-037        |
| P610903   | 364200-008        |
| P610905   | 364200-008        |
| P611859   | 364200-032        |
| P628326   | 365250-002        |
| P762591   | 364500-018        |
| P770123   | 364200-018        |
| P770372   | 364200-018        |
| P770589   | 364200-026        |
| P771538   | 364200-018        |
| P771543   | 364200-018        |
| P772579   | 364200-039        |
| P775300   | 360030-009        |
| P775749   | 364200-001        |
| P776730   | 364200-020        |
| P777279   | 364250-003        |
| P777409   | 364250-003        |
| P777414   | 364250-004        |
| P777654   | 364200-008        |

| OE Number              | Crown Part Number |
|------------------------|-------------------|
| P778404                | 364200-027        |
| P779146                | 364100-052        |
| P779148                | 364100-086        |
| P779150                | 364100-050        |
| P779152                | 364100-026        |
| P779164                | 364100-008        |
| P779180                | 364100-024        |
| P779184                | 364100-022        |
| P779191                | 364100-019        |
| P779193                | 364100-047        |
| P779197                | 364100-020        |
| P779208                | 364100-051        |
| P779215                | 364100-044        |
| P779217                | 364100-023        |
| P779218                | 364500-016        |
| P779219                | 364100-044        |
| P779523                | 364500-014        |
| P779600                | 364500-014        |
| P779612                | 364500-011        |
| P779662                | 364100-086        |
| P779671                | 364100-037        |
| P779961                | 364100-009        |
| P781466                | 364100-088        |
| P812432                | 364200-047        |
| P812440                | 364200-047        |
| P812537                | 364200-021        |
| P812543                | 364200-021        |
| P812588                | 364200-014        |
| P821575                | 364200-021        |
| P822686                | 364200-047        |
| P822768                | 364200-050        |
| P822769                | 364200-015        |
| P827653                | 364200-039        |
| P827654                | 364200-008        |
| P827655                | 364200-008        |
| P828889                | 364200-026        |
| P829332                | 380030-009        |
| P829333                | 364200-031        |
| P829964                | 364200-008        |
| P831424                | 364200-014        |
| PA640                  | 364200-009        |
| SBG1000343             | 364200-018        |
| SMP771538              | 364200-018        |
| SMP771543              | 364200-018        |
| WA923                  | 364900-001        |
| WA923-5                | 364900-001        |
| WA956                  | 364900-001        |
| WA9561                 | 364900-001        |
| <b>Doosan (DOS)</b>    |                   |
| 141106                 | 364200-017        |
| 65.12503-5016          | 364300-004        |
| 65.12515-5008          | 364600-003        |
| A213625                | 364200-010        |
| A213938                | A213938           |
| D141106                | 364200-017        |
| D141121                | 364200-017        |
| D501564                | 364500-002        |
| K1019575               | 364400-001        |
| <b>Fleetguard (FG)</b> |                   |
| 0009863                | 364900-001        |
| 3300391S               | 364300-002        |
| 70501                  | 364900-001        |
| AA2922                 | 364200-036        |
| AF1606K                | 364200-024        |
| AF1658                 | 364200-007        |
| AF1759                 | 364700-001        |
| AF1891                 | 364200-016        |

| OE Number | Crown Part Number |
|-----------|-------------------|
| AF2081    | 364900-001        |
| AF25042K  | 364200-020        |
| AF25070K  | 364200-003        |
| AF25220   | 364200-045        |
| AF25279   | 364200-013        |
| AF25280   | 364200-017        |
| AF25287K  | 364200-041        |
| AF25291   | 364200-039        |
| AF25292   | 364200-026        |
| AF25308   | 364200-010        |
| AF25337   | 364200-008        |
| AF25337M  | 364200-008        |
| AF25352   | 364200-026        |
| AF25437   | 364250-003        |
| AF25442   | 364200-028        |
| AF25477   | 364200-011        |
| AF25484   | 380030-009        |
| AF25485   | 364200-031        |
| AF25497   | 364200-015        |
| AF25519   | 364200-015        |
| AF25523   | 364250-004        |
| AF25526   | 364200-039        |
| AF25538   | 364200-047        |
| AF25550   | 364200-047        |
| AF25551   | 364200-021        |
| AF25554   | 364200-023        |
| AF25555   | 364200-039        |
| AF25556   | 380030-009        |
| AF25565   | 364200-040        |
| AF25575   | 364200-021        |
| AF25578M  | 364200-037        |
| AF25588   | 364200-039        |
| AF25636   | 364200-043        |
| AF25648   | 364200-008        |
| AF25684   | 364700-002        |
| AF25757   | 364200-043        |
| AF25854   | 364200-019        |
| AF25960   | 364250-002        |
| AF26193   | 364200-014        |
| AF26308   | 364200-043        |
| AF284     | 364200-009        |
| AF2974    | 364200-024        |
| AF3286    | 364700-001        |
| AF3497    | 364200-016        |
| AF350K    | 364200-046        |
| AF4059K   | 364200-036        |
| AF4066    | 364200-027        |
| AF409K    | 364200-018        |
| AF4102    | 364700-002        |
| AF435K    | 364200-002        |
| AF4536    | 380030-045        |
| AF4573K   | 364200-025        |
| AF4878    | 364200-045        |
| AF4923K   | 364200-001        |
| AF4924    | 364200-004        |
| AF4941K   | 364200-018        |
| AF70      | 364200-009        |
| AF7996    | 364200-019        |
| AG25576   | 364200-042        |
| AH19065   | 364200-036        |
| AH19066   | 364200-036        |
| AH19083   | 364200-021        |
| AH19084   | 364200-021        |
| AH19085   | 364200-021        |
| AH19086   | 364200-021        |
| AH19091   | 364200-039        |
| AH19092   | 364200-039        |

| OE Number    | Crown Part Number |
|--------------|-------------------|
| AH19093      | 364200-039        |
| AH19094      | 364200-039        |
| FF167        | 364300-003        |
| FF185        | 364300-031        |
| FF2203       | 364300-018        |
| FF4062       | 364300-001        |
| FF5018       | 364300-027        |
| FF5038       | 364300-017        |
| FF5052       | 364300-027        |
| FF5056       | 364300-017        |
| FF5103       | 364300-009        |
| FF5160       | 364600-003        |
| FF5245       | 364300-007        |
| FF5300       | 364300-015        |
| FF5320       | 364300-007        |
| FF5421       | 364300-029        |
| FF5494       | 364300-027        |
| FL2271979    | 364200-026        |
| FL26510342   | 364200-026        |
| FL2976002    | 364200-026        |
| FL2981113    | 364200-026        |
| FL46562      | 364200-026        |
| FL6005011111 | 364200-026        |
| FL69800017   | 364200-026        |
| FL7619404    | 364200-026        |
| FL84036676   | 364200-026        |
| FL873021003  | 364200-026        |
| FL92793025   | 364200-026        |
| FL9783       | 364200-026        |
| FL993216     | 364200-026        |
| FLAEM2668    | 364200-026        |
| FLAF25292    | 364200-026        |
| FLAF25352    | 364200-026        |
| FLAF9969     | 364200-026        |
| FLC17337     | 364200-026        |
| FLCA5741     | 364200-026        |
| FLDOP828889  | 364200-026        |
| FLP770589    | 364200-026        |
| FLP772580    | 364200-026        |
| FLP774602    | 364200-026        |
| FLP828889    | 364200-026        |
| FLRS3544     | 364200-026        |
| FLSA16580    | 364200-026        |
| FLWGA1080    | 364200-026        |
| FLX2950576   | 364200-026        |
| FS1001       | 364300-004        |
| FS1065       | 364300-030        |
| FS1212       | 364300-024        |
| FS1222       | 364300-024        |
| FS1235       | 364300-005        |
| FS1242B      | 364300-024        |
| FS1280       | 364300-017        |
| FS19514      | 364300-032        |
| FS19516      | 364300-008        |
| FS19530      | 364300-032        |
| FS19534      | 364300-005        |
| FS19573      | 364600-002        |
| FS19616      | 364300-023        |
| FS19811      | 364300-032        |
| FS19814      | 364300-032        |
| HF28783      | 364400-001        |
| HF28853      | 364500-012        |
| HF28857      | 364400-009        |
| HF28946      | 364500-010        |
| HF35005      | 364100-065        |
| HF35102      | 364500-008        |
| HF35140      | 364500-013        |

SERVICE SUPPLIES

**WARNING:** Cancer - [www.P65Warnings.ca.gov](http://www.P65Warnings.ca.gov)

Note: More crosses available; contact your dealer.

Fleetguard Continued ▶

# Filter Cross Reference

Fleetguard Continued

SERVICE SUPPLIES

| OE Number | Crown Part Number |
|-----------|-------------------|
| HF6005    | 364100-036        |
| HF6067    | 364100-029        |
| HF6080    | 364100-086        |
| HF6133    | 364100-029        |
| HF6137    | 364500-014        |
| HF6149    | 364500-011        |
| HF6177    | 364500-009        |
| HF6202    | 364500-005        |
| HF6206    | 364100-007        |
| HF6252    | 364500-010        |
| HF6337    | 364100-021        |
| HF6505    | 364100-040        |
| HF6517    | 364100-018        |
| HF6552    | 364100-018        |
| HF6710    | 364100-029        |
| HF6711    | 364500-014        |
| HF6749    | 364500-014        |
| HF7534    | 364500-014        |
| HF7904    | 364500-007        |
| HF7926    | 364100-021        |
| HF7947    | 364500-009        |
| HF929     | 364100-006        |
| LF115     | 364100-005        |
| LF117     | 364100-016        |
| LF155     | 364100-044        |
| LF16011   | 364400-001        |
| LF16015   | 364100-078        |
| LF16104   | 364100-084        |
| LF16176   | 364100-068        |
| LF16224   | 364100-071        |
| LF3306    | 364100-005        |
| LF3309    | 364100-023        |
| LF3310    | 364100-044        |
| LF3311    | 364100-020        |
| LF3314    | 364100-045        |
| LF3328    | 364100-051        |
| LF3335    | 364100-030        |
| LF3336    | 364100-004        |
| LF3338    | 364100-044        |
| LF3339    | 364100-039        |
| LF3341    | 364100-050        |
| LF3342    | 364500-016        |
| LF3345    | 364100-032        |
| LF3349    | 364500-015        |
| LF3361    | 364100-010        |
| LF3364    | 364950-001        |
| LF3377    | 364100-020        |
| LF3378    | 364100-020        |
| LF3400    | 364100-020        |
| LF3434    | 364100-001        |
| LF3435    | 364100-037        |
| LF3451    | 364100-045        |
| LF3462    | 364100-046        |
| LF3466    | 364100-034        |
| LF3486    | 364100-003        |
| LF3501    | 364100-050        |
| LF3547    | 364100-051        |
| LF3552    | 364500-015        |
| LF3568    | 364100-022        |
| LF3587    | 364100-051        |
| LF3588    | 364100-051        |
| LF3599    | 364100-009        |
| LF3600    | 364100-013        |
| LF3604    | 364100-023        |
| LF3614    | 364100-041        |
| LF3615    | 364100-041        |
| LF3624    | 364100-047        |

| OE Number        | Crown Part Number |
|------------------|-------------------|
| LF3630           | 364100-091        |
| LF3679           | 364100-048        |
| LF3681           | 364100-049        |
| LF3682           | 364100-081        |
| LF3690           | 364100-017        |
| LF3692           | 364100-065        |
| LF3703           | 364100-028        |
| LF3706           | 364100-081        |
| LF3713           | 364100-025        |
| LF3714           | 364100-047        |
| LF3758           | 364100-050        |
| LF3766           | 364100-044        |
| LF3776           | 364100-008        |
| LF3778           | 364100-080        |
| LF3806           | 364500-015        |
| LF3812           | 364100-008        |
| LF3855           | 364400-001        |
| LF385F           | 364100-001        |
| LF3886           | 364100-078        |
| LF3921           | 364500-015        |
| LF3933           | 364100-037        |
| LF3937           | 364100-083        |
| LF3945           | 364100-084        |
| LF3948           | 364100-011        |
| LF3970           | 364100-083        |
| LF4014           | 364100-044        |
| LF4015           | 364100-020        |
| LF402            | 364100-046        |
| LF4095           | 364500-009        |
| LF417            | 364100-014        |
| LF42502          | 364100-019        |
| LF488            | 364100-033        |
| LF542            | 364100-002        |
| LF574            | 364950-001        |
| LF583            | 364100-012        |
| LF607            | 364100-016        |
| LF678            | 364100-052        |
| LF67822          | 364100-052        |
| LF681            | 364100-086        |
| LF689            | 364100-050        |
| LF700            | 364100-038        |
| LF701            | 364100-026        |
| LF701ER          | 364100-026        |
| LF711            | 364100-024        |
| LF716            | 364100-008        |
| LF769            | 364500-005        |
| LF780            | 364100-024        |
| LF785            | 364100-022        |
| LF796            | 364100-019        |
| LF798            | 364100-047        |
| LF9024           | 364100-074        |
| LFH4955          | 364100-029        |
| PF2160           | 364500-012        |
| WF1012           | 364900-001        |
| WF2012           | 364900-001        |
| WF2053A          | 364900-001        |
| WF2061           | 364900-001        |
| WF2073           | 364900-001        |
| WF2125           | 364900-002        |
| WF2126           | 364900-002        |
| <b>Ford (FD)</b> |                   |
| 11425472         | 364100-020        |
| 11464467         | 364100-050        |
| 11464498         | 364100-050        |
| 11525472         | 364100-050        |
| 130366060        | 364300-009        |
| 1419455          | 364200-046        |

| OE Number    | Crown Part Number |
|--------------|-------------------|
| 1457512      | 364100-044        |
| 1482151      | 364100-050        |
| 1498017      | 364100-050        |
| 1498022      | 364100-044        |
| 1498435      | 364200-048        |
| 1508831      | 364100-050        |
| 1515160      | 364100-050        |
| 1520660      | 364100-050        |
| 1536304      | 364100-044        |
| 1553370      | 364100-044        |
| 1555451      | 364100-050        |
| 1559937      | 364100-044        |
| 1651563      | 364900-001        |
| 1696300351   | 364900-001        |
| 178562       | 364100-020        |
| 1S7Z-6731-DA | 364400-001        |
| 2000E-9601-A | 364200-046        |
| 200E-9601-A  | 364200-046        |
| 213188       | 364200-048        |
| 26550001     | 364900-001        |
| 3315115      | 364900-001        |
| 3963907      | 364100-026        |
| 3H-217       | 364200-046        |
| 40491        | 364900-001        |
| 457412       | 364500-009        |
| 5000185      | 364100-050        |
| 5000480      | 364100-044        |
| 5000513      | 364100-026        |
| 5000829      | 364950-001        |
| 5001156      | 364100-050        |
| 5001248      | 364100-050        |
| 5001753      | 364950-001        |
| 5002230      | 364100-050        |
| 5002454      | 364100-080        |
| 5002530      | 364100-044        |
| 5003329      | 364100-044        |
| 5003331      | 364100-044        |
| 5003455      | 364100-046        |
| 5003456      | 364100-008        |
| 5003607      | 364200-048        |
| 5003914      | 364100-044        |
| 5003929      | 364100-044        |
| 5003930      | 364100-044        |
| 5003967      | 364100-044        |
| 5003968      | 364100-044        |
| 5004264      | 364200-027        |
| 5004388      | 364100-008        |
| 5004748      | 364950-001        |
| 5004926      | 364100-044        |
| 5004930      | 364100-050        |
| 5005079      | 364100-008        |
| 5005080      | 364100-008        |
| 5005572      | 364100-044        |
| 5006227      | 364100-047        |
| 5007123      | 364950-001        |
| 5007222      | 364100-050        |
| 5008589      | 364100-050        |
| 5008677      | 364100-050        |
| 5008720      | 364100-044        |
| 5008721      | 364100-044        |
| 5008722      | 364100-044        |
| 5009088      | 364100-044        |
| 5009421      | 364100-050        |
| 5010292      | 364100-017        |
| 5011322      | 364200-046        |
| 5011553      | 364200-046        |
| 5012037      | 364100-050        |

| OE Number      | Crown Part Number |
|----------------|-------------------|
| 5012555        | 364100-044        |
| 5012580        | 364100-045        |
| 5013149        | 364100-050        |
| 5013319        | 364100-044        |
| 5018034        | 364300-013        |
| 5022798        | 364100-008        |
| 5023923        | 364300-013        |
| 542957         | 364100-020        |
| 5582           | 364250-001        |
| 6041176        | 364100-044        |
| 6063340        | 364100-050        |
| 6066094        | 364100-044        |
| 6066095        | 364100-044        |
| 6066096        | 364100-044        |
| 6123881        | 364300-024        |
| 70HM-6714-AA   | 364100-050        |
| 741M-6714-BA   | 364100-044        |
| 741M-6714-CA   | 364100-044        |
| 74HM-6714-BA   | 364100-026        |
| 78HM-6714-AA   | 364100-050        |
| 78TM-6714-BA   | 364100-050        |
| 81SM-6714-A3A  | 364100-044        |
| 81SM-6714-A4A  | 364100-044        |
| 83970552       | 364300-009        |
| 83971969       | 364900-001        |
| 83987767       | 364900-001        |
| 83DB-9155-AA   | 364300-024        |
| 949418         | 364900-001        |
| 9613322        | 364100-052        |
| 9613324        | 364100-026        |
| 9613327        | 364100-045        |
| 9832825        | 364200-048        |
| 9912-15115     | 364900-001        |
| 991215115      | 364900-001        |
| 9N-18632       | 364950-001        |
| 9N-18649       | 364950-001        |
| 9N-18658-A     | 364950-001        |
| 9N-18662       | 364950-001        |
| 9N-6123        | 364900-001        |
| 9N-6714        | 364950-001        |
| 9N-6731        | 364950-001        |
| A690X-6A692-RA | 364100-044        |
| A700X-6714-AA  | 364100-044        |
| A700X-6714-JA  | 364100-044        |
| A700X-671DA    | 364100-080        |
| A700X-6731-ADA | 364950-001        |
| A700X-6731-DA  | 364950-001        |
| A700X-9601-ACA | 364200-048        |
| A720X-6714-FA  | 364100-044        |
| A730X-6714-AA  | 364100-044        |
| A730X-6714-BA  | 364100-026        |
| A730X-6731-S1A | 364950-001        |
| A730X-6731-S2A | 364950-001        |
| A740X-6714-CA  | 364100-050        |
| A740X-6731-KA  | 364950-001        |
| A760X-6714-DA  | 364100-080        |
| A760X-6714-KA  | 364100-044        |
| A770X-6714-ABA | 364100-044        |
| A770X-6714-ACA | 364100-044        |
| A770X-6714-BA  | 364100-044        |
| A770X-6714-DA  | 364100-044        |
| A770X-6714-GA  | 364100-008        |
| A770X-6714-NA  | 364100-044        |
| A770X-6714-SA  | 364100-044        |
| A770X-6714-TA  | 364100-044        |
| A780X-6714-AA  | 364100-008        |
| A780X-6714-EA  | 364100-044        |

**WARNING:** Cancer - [www.P65Warnings.ca.gov](http://www.P65Warnings.ca.gov)  
 Note: More crosses available; contact your dealer.

Ford Continued ▶

# Filter Cross Reference

Ford Continued

| OE Number       | Crown Part Number |
|-----------------|-------------------|
| A780X-6714-MA   | 364100-008        |
| A780X-6714-NA   | 364100-008        |
| A780X-6731-AA   | 364950-001        |
| A780X-9601-CA   | 364200-027        |
| A790X-6714-BA   | 364100-044        |
| A790X-6714-CA   | 364100-044        |
| A800X-6714-AA   | 364100-047        |
| A800X-6714-EA   | 364100-080        |
| A800X-6731-BA   | 364950-001        |
| A810X-6714-JA   | 364100-044        |
| A810X-6714-KA   | 364100-044        |
| A810X-6714-LA   | 364100-044        |
| A830X-9601-AFA  | 364200-046        |
| A830X-9601-CDCA | 364200-046        |
| AFL5033         | 364100-047        |
| AFL56           | 364100-008        |
| APN-18649       | 364950-001        |
| APN-18649-B     | 364950-001        |
| APN-6731-B      | 364950-001        |
| C4R-9155-B      | 364300-034        |
| C5ZZ-6731-A     | 364100-050        |
| C6JZ-6714-A     | 364100-020        |
| C6JZ-6714-B     | 364100-020        |
| CCOZ-6714-AG    | 364100-020        |
| D1RY-6731-A     | 364100-020        |
| D27Z-6731-A     | 364100-008        |
| D27Z-6731-ADP   | 364100-008        |
| D4ZZ-6731-B     | 364100-050        |
| D87Z-6731-A     | 364100-008        |
| D8PJ-6714-AA    | 364100-020        |
| D8PZ-6731-A     | 364100-020        |
| D9HZ-6731-A     | 364500-016        |
| D9HZ-6731-B     | 364500-016        |
| D9PJ-6714-AA    | 364500-016        |
| DITS-9600-AA    | 364200-046        |
| DL-9601-A       | 364200-046        |
| E3HZ-6731-C     | 364500-015        |
| E73Z-6731-B     | 364100-047        |
| E7GZ-6731-A     | 364100-046        |
| E7HZBA424A      | 364900-001        |
| E7NN-6714-DA    | 364100-050        |
| E8BZ-6731-A     | 364100-046        |
| E8HZ-44420-A    | 364100-050        |
| E8NN-6714-CA    | 364100-020        |
| E92Z-6731-A     | 364100-008        |
| E92Z-9731-A     | 364100-008        |
| E9GZ-6731-A     | 364100-065        |
| E9NN-6714-AA    | 364100-020        |
| ET6-18660       | 364950-001        |
| F1AE-6714-BC    | 364100-049        |
| F1AZ-6731-A     | 364100-049        |
| F1AZ-6731-BD    | 364100-049        |
| F1HT-9155-BA    | 364300-024        |
| F3HZ-6731-A     | 364500-015        |
| F3HZ-6731-B     | 364500-015        |
| F3HZ-6731-C     | 364500-015        |
| F3HZ-8A424-D    | 364900-001        |
| F3HZ-9162-A     | 364300-017        |
| F3HZ-9601-A     | 364200-045        |
| F3HZ-9601-B     | 364200-045        |
| F3HZ-9601-C     | 364500-015        |
| F3HZ-9601-D     | 364200-045        |
| F3HZ-9601-DC    | 364200-045        |
| FL322           | 364100-038        |
| FL813           | 364100-047        |
| KJ22065         | 364200-046        |
| KOH-235116      | 364200-048        |

| OE Number        | Crown Part Number |
|------------------|-------------------|
| SBA130366050     | 364300-009        |
| SBA130366060     | 364300-009        |
| SBA140517020     | 364400-001        |
| V104040          | 364900-001        |
| V34778           | 364100-026        |
| V79080           | 364300-024        |
| V88833           | 364300-017        |
| V88834           | 364300-027        |
| <b>Fram (FR)</b> |                   |
| B328             | 364500-012        |
| BPH43            | 364100-050        |
| BT8417           | 364500-012        |
| BT8417B          | 364500-012        |
| C1191A           | 364300-003        |
| C1723            | 364500-005        |
| C1723A           | 364500-005        |
| C3               | 364950-001        |
| C3P              | 364950-001        |
| C7330            | 364100-065        |
| C827             | 364950-001        |
| C842             | 364950-001        |
| C891             | 364950-001        |
| C988             | 364950-001        |
| C988C            | 364950-001        |
| CA19946          | 364200-053        |
| CA120PL          | 364200-048        |
| CA169            | 364200-049        |
| CA169PL          | 364200-049        |
| CA169PL2         | 364200-049        |
| CA4300           | 364200-027        |
| CA5745           | 364200-039        |
| CA649PL          | 364200-048        |
| CA7111SY         | 364200-027        |
| CA7139           | 364200-045        |
| CA7242           | 364200-027        |
| CA7695           | 364200-045        |
| CA77             | 364200-048        |
| CA770E           | 364200-048        |
| CA8621           | 364250-003        |
| CA8737           | 364200-026        |
| CA8755           | 364200-043        |
| CA8755A          | 364200-043        |
| CA8756           | 364200-043        |
| CA9248           | 364200-047        |
| CA9268           | 364200-019        |
| CA9269           | 364200-019        |
| CA9550           | 364200-021        |
| CAK254           | 364200-046        |
| CAK565           | 364200-036        |
| CAK8390          | 364200-018        |
| CH2870A          | 364100-022        |
| CH2872           | 364100-009        |
| CH6482           | 364500-011        |
| CH8530           | 364100-068        |
| DG16             | 364100-020        |
| DG2              | 364100-049        |
| DG2849A          | 364100-008        |
| DG2870A          | 364100-022        |
| DG3387A          | 364100-024        |
| DG3675           | 364100-084        |
| DG3682           | 364100-001        |
| DG3950           | 364100-004        |
| DG3980           | 364100-003        |
| DG43             | 364100-050        |
| DG4967           | 364100-041        |
| DG6607           | 364100-065        |
| DG7317           | 364100-065        |

| OE Number | Crown Part Number |
|-----------|-------------------|
| F3P       | 364950-001        |
| FA120PL   | 364200-048        |
| G3        | 364300-034        |
| G15       | 364300-034        |
| GH110     | 364100-023        |
| GH160     | 364950-001        |
| HP-1      | 364100-034        |
| K1532     | 364200-024        |
| K3926     | 364300-024        |
| LFP815F   | 364300-002        |
| LFP815FN  | 364300-002        |
| P16551A   | 364100-086        |
| P16552A   | 364100-086        |
| P16553A   | 364100-086        |
| P16554A   | 364100-086        |
| P2805     | 364100-016        |
| P2814     | 364100-050        |
| P29195    | 364200-018        |
| P3415     | 364100-035        |
| P3711     | 364300-027        |
| P3761     | 364100-037        |
| P3961     | 364500-014        |
| P4157     | 364300-001        |
| P4520     | 364300-013        |
| P4688     | 364300-027        |
| P4886     | 364600-003        |
| P5068     | 364100-007        |
| P5157     | 364300-015        |
| P5158     | 364500-009        |
| P6808     | 364500-009        |
| P6881     | 364100-018        |
| P7040     | 364500-014        |
| P7510     | 364300-013        |
| P7542     | 364500-014        |
| P7559     | 364500-009        |
| P8267     | 364500-009        |
| P8317     | 364500-012        |
| P8334     | 364300-007        |
| P8707     | 364500-012        |
| P9280     | 364100-037        |
| P961PL    | 364100-050        |
| PA2844    | 364100-042        |
| PCS5059   | 364300-024        |
| PCS5059M  | 364300-024        |
| PCS5062   | 364300-024        |
| PCS5062M  | 364300-024        |
| PER3911   | 364900-001        |
| PF9715    | 364100-065        |
| PH16      | 364100-020        |
| PH16FP    | 364100-020        |
| PH2       | 364100-049        |
| PH20      | 364100-052        |
| PH208     | 364100-052        |
| PH20A     | 364100-052        |
| PH228     | 364100-020        |
| PH28001   | 364100-023        |
| PH28032   | 364100-026        |
| PH28041   | 364100-026        |
| PH2806A   | 364100-023        |
| PH2807    | 364100-050        |
| PH2815    | 364100-045        |
| PH2816    | 364100-023        |
| PH2816S   | 364100-022        |
| PH2820A   | 364100-020        |
| PH2821C   | 364100-026        |
| PH28231   | 364100-023        |
| PH2832    | 364100-020        |

| OE Number | Crown Part Number |
|-----------|-------------------|
| PH2835    | 364100-030        |
| PH2840    | 364100-041        |
| PH2844    | 364100-044        |
| PH2849A   | 364100-006        |
| PH2855    | 364100-020        |
| PH2855A   | 364100-020        |
| PH2857A   | 364100-023        |
| PH2861A   | 364100-030        |
| PH2861B   | 364100-050        |
| PH2862C   | 364100-024        |
| PH2863    | 364100-023        |
| PH28631   | 364100-023        |
| PH2868    | 364100-023        |
| PH2870    | 364100-022        |
| PH2870A   | 364100-022        |
| PH2870B   | 364100-022        |
| PH2871    | 364100-008        |
| PH2879    | 364100-050        |
| PH2885A   | 364100-075        |
| PH2895    | 364100-038        |
| PH2899    | 364100-050        |
| PH28A     | 364100-039        |
| PH2919    | 364100-080        |
| PH2951    | 364100-017        |
| PH2953A   | 364100-033        |
| PH2954    | 364100-075        |
| PH2957    | 364100-022        |
| PH2964    | 364100-044        |
| PH2978    | 364100-037        |
| PH2990    | 364100-023        |
| PH2993    | 364100-023        |
| PH2FP     | 364100-049        |
| PH3353    | 364100-019        |
| PH3354    | 364100-024        |
| PH3387    | 364100-024        |
| PH3387A   | 364100-024        |
| PH3387AFP | 364100-024        |
| PH3432    | 364100-019        |
| PH35      | 364100-050        |
| PH3503    | 364100-021        |
| PH3506    | 364100-019        |
| PH3508    | 364100-045        |
| PH3512    | 364100-080        |
| PH3516    | 364100-008        |
| PH3519    | 364500-016        |
| PH3519A   | 364500-016        |
| PH3545    | 364100-051        |
| PH3567    | 364100-029        |
| PH3569    | 364100-045        |
| PH3593A   | 364100-058        |
| PH3614    | 364100-030        |
| PH3651A   | 364100-037        |
| PH3664    | 364100-047        |
| PH3675    | 364100-084        |
| PH3786    | 364100-091        |
| PH3786FP  | 364100-091        |
| PH3807    | 364100-008        |
| PH3807A   | 364100-008        |
| PH3816    | 364100-044        |
| PH3900    | 364100-032        |
| PH3917    | 364100-008        |
| PH3946    | 364100-047        |
| PH3976    | 364500-015        |
| PH3976FP  | 364500-015        |
| PH43      | 364100-050        |
| PH4386    | 364100-011        |
| PH43FP    | 364100-050        |

SERVICE SUPPLIES

⚠ WARNING: Cancer - [www.P65Warnings.ca.gov](http://www.P65Warnings.ca.gov)  
 Note: More crosses available; contact your dealer.

Fram Continued ▶

# Filter Cross Reference

Fram Continued

| OE Number                  | Crown Part Number |
|----------------------------|-------------------|
| PH4469                     | 364100-051        |
| PH4478                     | 364100-023        |
| PH4482                     | 364100-075        |
| PH4557                     | 364400-006        |
| PH46A                      | 364100-075        |
| PH4703A                    | 364100-047        |
| PH4722                     | 364100-024        |
| PH4722A                    | 364100-024        |
| PH4743                     | 364100-026        |
| PH48                       | 364100-050        |
| PH4806                     | 364100-080        |
| PH4824                     | 364100-020        |
| PH4826                     | 364100-013        |
| PH4883                     | 364100-022        |
| PH4913                     | 364100-008        |
| PH4967                     | 364100-041        |
| PH4998                     | 364100-065        |
| PH5                        | 364100-048        |
| PH5195                     | 364100-008        |
| PH5491                     | 364100-023        |
| PH5693                     | 364100-088        |
| PH5FP                      | 364100-048        |
| PH6010A                    | 364100-046        |
| PH6017                     | 364100-065        |
| PH6017A                    | 364100-065        |
| PH6607                     | 364100-065        |
| PH6682                     | 364100-022        |
| PH6811                     | 364100-046        |
| PH7226                     | 364100-023        |
| PH7328                     | 364100-020        |
| PH7575                     | 364100-030        |
| PH8                        | 364100-034        |
| PH8026                     | 364100-033        |
| PH8476                     | 364100-028        |
| PH8942                     | 364100-083        |
| PH922A1                    | 364100-020        |
| PH9566                     | 364400-001        |
| PH961                      | 364100-037        |
| PH965                      | 364100-020        |
| PH966B                     | 364100-044        |
| PH966B11                   | 364100-044        |
| PH9715                     | 364100-065        |
| PH977A                     | 364100-052        |
| PH9837                     | 364100-084        |
| PR3392                     | 364900-001        |
| PR3910                     | 364900-001        |
| PR8693                     | 364900-002        |
| PS3712                     | 364300-024        |
| PS7407                     | 364300-008        |
| PS8047                     | 364300-004        |
| PS9127                     | 364300-032        |
| S3TC                       | 364950-001        |
| TG3675                     | 364100-084        |
| TG4967                     | 364100-041        |
| TG6607                     | 364100-065        |
| TG7317                     | 364100-065        |
| XG2                        | 364100-049        |
| XG43                       | 364100-050        |
| XG5                        | 364100-048        |
| <b>General Motors (GM)</b> |                   |
| 02971113                   | 364300-031        |
| 0339-4112                  | 364950-001        |
| 12339037                   | 364100-008        |
| 12339909                   | 364100-008        |
| 12339995                   | 364100-041        |
| 1513904                    | 364200-019        |
| 15153904                   | 364200-019        |

| OE Number | Crown Part Number |
|-----------|-------------------|
| 15511626  | 364100-051        |
| 15516983  | 364300-024        |
| 1553681   | 364200-048        |
| 1553691   | 364200-048        |
| 15619013  | 364200-045        |
| 15696245  | 364200-045        |
| 15908916  | 364200-043        |
| 19166110  | 364200-043        |
| 21000872  | 364100-075        |
| 25010155  | 364950-001        |
| 25010157  | 364950-001        |
| 25010251  | 364100-019        |
| 25010277  | 364100-047        |
| 25010766  | 364100-024        |
| 25010964  | 364500-005        |
| 25010965  | 364500-005        |
| 25011099  | 364500-016        |
| 25011122  | 364500-016        |
| 25011130  | 364100-026        |
| 25011131  | 364100-026        |
| 25011159  | 364500-016        |
| 25011162  | 364100-052        |
| 25011165  | 364500-016        |
| 25011168  | 364100-086        |
| 25011229  | 364100-086        |
| 25011230  | 364100-086        |
| 25011292  | 364100-050        |
| 25011293  | 364100-050        |
| 25011354  | 364100-008        |
| 25011574  | 364100-008        |
| 25011689  | 364300-024        |
| 25011693  | 364300-024        |
| 25011902  | 364100-051        |
| 25011997  | 364500-015        |
| 25012001  | 364300-017        |
| 25012003  | 364300-027        |
| 25012355  | 364500-011        |
| 25012428  | 364500-009        |
| 25012488  | 364500-014        |
| 25012895  | 364900-001        |
| 25013977  | 364100-048        |
| 25014422  | 364100-065        |
| 25014520  | 364100-049        |
| 25014748  | 364100-084        |
| 25014818  | 364100-044        |
| 25026209  | 364100-047        |
| 25096246  | 364200-027        |
| 25160561  | 364100-048        |
| 25161877  | 364100-046        |
| 25161878  | 364100-008        |
| 25161879  | 364100-008        |
| 25161880  | 364100-041        |
| 25171946  | 364100-065        |
| 25177526  | 364200-048        |
| 25312506  | 364500-016        |
| 25313348  | 364200-043        |
| 25313349  | 364200-043        |
| 25313741  | 364100-051        |
| 3448991   | 364100-045        |
| 3448992   | 364100-045        |
| 4984919   | 364100-045        |
| 5570003   | 364950-001        |
| 5570148   | 364950-001        |
| 5570234   | 364950-001        |
| 5570295   | 364950-001        |
| 5573444   | 364950-001        |
| 5577618   | 364100-020        |

| OE Number | Crown Part Number |
|-----------|-------------------|
| 5579164   | 364100-020        |
| 5646812   | 364200-049        |
| 5646813   | 364200-049        |
| 5648137   | 364200-049        |
| 5649798   | 364200-049        |
| 6420249   | 364200-049        |
| 6420322   | 364200-049        |
| 6421824   | 364200-048        |
| 6423028   | 364200-049        |
| 6423108   | 364200-048        |
| 6423122   | 364200-048        |
| 6423425   | 364200-049        |
| 64363832  | 364100-052        |
| 6437419   | 364100-020        |
| 6437968   | 364100-052        |
| 6438122   | 364100-086        |
| 6438162   | 364100-050        |
| 6439142   | 364100-050        |
| 6439143   | 364100-050        |
| 6439354   | 364100-047        |
| 6439355   | 364100-008        |
| 6439412   | 364950-001        |
| 6439517   | 364100-008        |
| 6439518   | 364100-008        |
| 6488346   | 364200-036        |
| 650352    | 364100-044        |
| 650362    | 364100-045        |
| 650364    | 364100-044        |
| 650365    | 364100-044        |
| 650373    | 364100-044        |
| 650400    | 364100-044        |
| 6696776   | 364100-044        |
| 7884256   | 364100-044        |
| 7965049   | 364100-044        |
| 7965051   | 364100-044        |
| 7973235   | 364100-044        |
| 7973429   | 364100-044        |
| 7984153   | 364100-080        |
| 7984229   | 364100-026        |
| 7984366   | 364100-050        |
| 7984452   | 364950-001        |
| 7984655   | 364100-045        |
| 81093682  | 364200-036        |
| 813566    | 364300-013        |
| 88971573  | 364100-041        |
| 893156634 | 364100-008        |
| 90027778  | 364100-044        |
| 90166585  | 364300-013        |
| 9059521   | 364200-036        |
| 9059571   | 364200-036        |
| 91176162  | 364100-017        |
| 93156186  | 364100-075        |
| 93156299  | 364100-044        |
| 93156363  | 364100-045        |
| 93156665  | 364100-046        |
| 93156666  | 364100-008        |
| 93156670  | 364100-017        |
| 93156769  | 364100-047        |
| 93891769  | 364300-013        |
| 94037791  | 364100-051        |
| 9414941   | 364100-046        |
| 94149418  | 364100-046        |
| 94201942  | 364100-047        |
| 94412815  | 364100-008        |
| 94456741  | 364100-046        |
| 94459700  | 364100-008        |
| 94847351  | 364100-041        |

| OE Number          | Crown Part Number |
|--------------------|-------------------|
| 94851874           | 364100-041        |
| 94853643           | 364100-041        |
| 94858995           | 364100-041        |
| 96058042           | 364100-017        |
| 97182282           | 364100-045        |
| 9974200            | 364200-027        |
| 9975227            | 364100-075        |
| 9975267            | 364100-045        |
| P2275              | 364500-012        |
| V1119324           | 364100-050        |
| <b>Hyster (HY)</b> |                   |
| 0060518            | 364950-001        |
| 0060978            | 364950-001        |
| 0127644            | 364100-012        |
| 01328692           | 380030-180        |
| 0156391            | 364200-018        |
| 0156954            | 364200-046        |
| 0168031            | 364200-046        |
| 0169741            | 364100-005        |
| 0179952            | 364200-046        |
| 0179961            | 364200-046        |
| 0179967            | 364200-046        |
| 0180595            | 364100-007        |
| 0182490            | 364950-001        |
| 0230413            | 364300-001        |
| 0231488            | 364100-005        |
| 0258237            | 364100-037        |
| 0259964            | 364100-005        |
| 0295599            | 364100-005        |
| 0305080            | 364200-003        |
| 0309112A           | 364100-020        |
| 0324692            | 364100-008        |
| 0327645            | 364300-003        |
| 0333642            | 364100-006        |
| 0350073            | 364300-034        |
| 0369398            | 074105            |
| 0379411            | 364200-003        |
| 0385951            | 364300-027        |
| 0803864            | 364300-003        |
| 0804990            | 364950-001        |
| 0841244            | 364500-009        |
| 0993774            | 364950-001        |
| 127644             | 364100-012        |
| 1304953            | 364300-034        |
| 1304950            | 380030-047        |
| 1306331            | 364300-001        |
| 1307931            | 364200-018        |
| 1320000            | 364100-003        |
| 1320000-M          | 364100-003        |
| 1324476            | 364600-003        |
| 1324476            | 364600-003        |
| 1327905            | 380103-911        |
| 1328691            | 364100-034        |
| 1328692            | 380030-180        |
| 1330033            | 364600-003        |
| 1334350            | 364600-003        |
| 1337159            | 380030-128        |
| 134887             | 364200-018        |
| 1350036            | 364100-043        |
| 1360190            | 364200-007        |
| 1360557            | 380030-128        |
| 1361808            | 364100-006        |
| 1368758            | 364600-003        |
| 1368795            | 364100-033        |
| 1368864            | 364100-020        |
| 1369809            | 364200-002        |
| 1369907            | 364100-006        |

⚠ **WARNING:** Cancer - [www.P65Warnings.ca.gov](http://www.P65Warnings.ca.gov)

Note: More crosses available; contact your dealer.

Hyster Continued ▶



# Filter Cross Reference

Hyster Continued

| OE Number | Crown Part Number |
|-----------|-------------------|
| 1375550   | 364400-002        |
| 1377080   | 364200-010        |
| 1457828   | 364100-037        |
| 1462439   | 380030-123        |
| 1499886   | 364300-034        |
| 1507231   | 364250-004        |
| 1507234   | 364250-003        |
| 1507235   | 364250-004        |
| 1512123   | 364500-015        |
| 1512430   | 364300-017        |
| 1512454   | 364500-015        |
| 1524551   | 364100-083        |
| 1543356   | 364300-023        |
| 154818    | 364200-018        |
| 1553541   | 364300-034        |
| 1559418   | 380030-064        |
| 156172    | 364300-031        |
| 156391    | 364200-018        |
| 156931    | 364200-018        |
| 156954    | 364200-046        |
| 1574111   | 364200-032        |
| 1584120   | 380030-068        |
| 1588143   | 364500-015        |
| 1588825   | 364500-015        |
| 1620142   | 364250-001        |
| 1688246   | 364250-003        |
| 1688248   | 364250-003        |
| 169741    | 364100-005        |
| 170681    | 364200-018        |
| 1707194   | 380030-162        |
| 176683    | 364100-032        |
| 179952    | 364200-046        |
| 179955    | 364200-018        |
| 179967    | 364200-046        |
| 180282    | 364100-016        |
| 180283    | 364100-020        |
| 1804017   | 364500-012        |
| 180595    | 364100-007        |
| 182490    | 364950-001        |
| 182645    | 364200-046        |
| 194740    | 364500-012        |
| 195852    | 364100-026        |
| 201571    | 364300-001        |
| 2021461   | 364100-020        |
| 2021933   | 364500-003        |
| 2021935   | 380102-349        |
| 2028654   | 364200-010        |
| 2033611   | 364200-002        |
| 2033682   | 364100-012        |
| 2034117   | 364200-021        |
| 2038072   | 364100-003        |
| 2039646   | 364500-010        |
| 2040364   | 364200-003        |
| 2040365   | 364200-026        |
| 2045606   | 364500-019        |
| 2048047   | 364200-042        |
| 2065754   | 364400-006        |
| 2067518   | 364400-006        |
| 2075558   | 364400-006        |
| 2070611   | 380030-162        |
| 2089366   | 364400-006        |
| 2305543   | 364100-035        |
| 2314368   | 364200-003        |
| 231488    | 364100-005        |
| 251755-12 | 364100-064        |
| 258237    | 364100-037        |
| 259025    | 364100-038        |

| OE Number | Crown Part Number |
|-----------|-------------------|
| 259264    | 364100-026        |
| 259964    | 364100-005        |
| 290732    | 364200-024        |
| 295599    | 364100-005        |
| 297865    | 364100-034        |
| 3000042   | 364500-009        |
| 3000043   | 364100-016        |
| 3000046   | 364100-005        |
| 3000047   | 364100-034        |
| 3000058   | 364100-050        |
| 3000059   | 364100-005        |
| 3000063   | 364500-012        |
| 3000065   | 364100-006        |
| 3000066   | 364100-007        |
| 3000068   | 364100-035        |
| 3000084   | 364500-011        |
| 3000107   | 364200-006        |
| 3000111   | 364200-009        |
| 3000227   | 364100-035        |
| 3000231   | 364100-038        |
| 3000240   | 077145            |
| 3000243   | 364100-004        |
| 3000244   | 364100-036        |
| 3000249   | 364100-038        |
| 3000328   | 364200-046        |
| 3000329   | 364200-003        |
| 3000331   | 364200-018        |
| 3000339   | 364200-007        |
| 3000340   | 364200-003        |
| 3000526   | 364200-003        |
| 3000538   | 077145            |
| 3000539   | 364100-001        |
| 3000856   | 364100-007        |
| 3000870   | 364100-064        |
| 3002377   | 077145            |
| 3002381   | 364200-002        |
| 3003599   | 364100-013        |
| 3005980   | 077145            |
| 3006174   | 364100-018        |
| 3006350   | 364500-012        |
| 3006884   | 074105            |
| 3006890   | 364200-004        |
| 3016477   | 364100-034        |
| 3019430   | 364500-016        |
| 3020819   | 364200-028        |
| 3020900   | 364600-003        |
| 3020904   | 364200-001        |
| 3020906   | 364300-015        |
| 3020911   | 364200-002        |
| 3021036   | 364300-031        |
| 3027062   | 364300-031        |
| 3035679   | 364100-002        |
| 3035750   | 364200-003        |
| 3035751   | 364200-002        |
| 3035752   | 364100-016        |
| 3040015   | 364300-003        |
| 3040036   | 364100-005        |
| 3040047   | 364100-038        |
| 3040066   | 364200-002        |
| 3040204   | 364500-009        |
| 3040205   | 364500-011        |
| 3040874   | 364200-027        |
| 3040875   | 364300-003        |
| 3040987   | 364300-003        |
| 3041065   | 364200-016        |
| 3041500   | 364200-033        |
| 3041630   | 364100-030        |

| OE Number | Crown Part Number |
|-----------|-------------------|
| 3041828   | 364200-006        |
| 3041879   | 364300-003        |
| 3041904   | 364100-032        |
| 3042045   | 364100-032        |
| 3042059   | 364100-001        |
| 3042258   | 364500-012        |
| 3043552   | 364600-003        |
| 3044227   | 364200-001        |
| 3044229   | 364200-003        |
| 3044230   | 364100-009        |
| 3045509   | 364200-003        |
| 3049210   | 364300-015        |
| 305080    | 364200-003        |
| 3051156   | 364300-003        |
| 3051531   | 364200-046        |
| 3051790   | 364200-002        |
| 3051791   | 364100-016        |
| 3051792   | 364100-020        |
| 3051794   | 077145            |
| 3051898   | 364100-005        |
| 3052457   | 364100-038        |
| 3052867   | 364200-003        |
| 3052982   | 364200-002        |
| 3053707   | 364200-018        |
| 3065108   | 364500-003        |
| 3066680   | 364500-009        |
| 3070501   | 364900-001        |
| 3070503   | 364300-017        |
| 3071263   | 364300-024        |
| 309112    | 364100-020        |
| 3096293   | 364100-079        |
| 3101099   | 364100-044        |
| 3115428   | 364500-010        |
| 3120941   | 364400-007        |
| 3121285   | 364100-014        |
| 3121567   | 364300-027        |
| 3122704   | 364100-033        |
| 3123959   | 364100-035        |
| 3124027   | 364100-015        |
| 3125993   | 364100-036        |
| 3130925   | 364400-004        |
| 3131804   | 364500-015        |
| 3131805   | 364300-017        |
| 3133746   | 364300-015        |
| 3134130   | 364100-026        |
| 3135948   | 364100-038        |
| 3135954   | 364200-010        |
| 313796    | 380030-128        |
| 3140102   | 364500-012        |
| 3140677   | 364400-001        |
| 3142480   | 364500-015        |
| 3142484   | 364300-017        |
| 3142965   | 364200-002        |
| 3143748   | 364500-012        |
| 3149713   | 364300-032        |
| 3172629   | 364500-003        |
| 324376    | 364200-002        |
| 324692    | 364100-008        |
| 326483    | 364200-002        |
| 327645    | 364300-003        |
| 333642    | 364100-006        |
| 336567    | 364200-024        |
| 342347    | 364300-015        |
| 369398    | 074105            |
| 375588    | 364100-003        |
| 379411    | 364200-003        |
| 385951    | 364300-027        |

| OE Number               | Crown Part Number |
|-------------------------|-------------------|
| 4000997                 | 380030-162        |
| 4020588                 | 364400-006        |
| 4033254                 | 364300-030        |
| 4090340                 | 364100-092        |
| 4096874                 | 364100-081        |
| 4105311                 | 364200-052        |
| 42863BS                 | 364100-026        |
| 5021                    | 364100-026        |
| 60518                   | 364950-001        |
| 60518-24                | 364950-001        |
| 60978                   | 364950-001        |
| 80126812                | 364200-050        |
| 80143916                | 364200-050        |
| 803864                  | 364300-003        |
| 804990                  | 364950-001        |
| 841244                  | 364500-009        |
| 8500023                 | 364400-002        |
| 8528508                 | 364400-006        |
| 865571                  | 364300-001        |
| 865761                  | 364200-002        |
| 993774                  | 364950-001        |
| S007624611              | 364200-039        |
| <b>Junghenrich (JU)</b> |                   |
| 14043500                | 364300-003        |
| 140435002               | 364300-003        |
| 1404996                 | 364200-027        |
| 14049960                | 364200-027        |
| 1410487                 | 364200-018        |
| 14104870                | 364200-018        |
| 141048706               | 364200-018        |
| 1411463                 | 364600-003        |
| 1432639                 | 364100-036        |
| 14326390                | 364100-036        |
| 14341450                | 364300-003        |
| 1434228                 | 364100-036        |
| 14342280                | 364100-036        |
| 1436599                 | 364100-006        |
| 14365990                | 364100-006        |
| 143659905               | 364100-006        |
| 1437927                 | 364500-003        |
| 14379270                | 364500-003        |
| 1448305                 | 364500-010        |
| 14483050                | 364500-010        |
| 14521664                | 364100-003        |
| 14712700                | 364600-003        |
| 14712720                | 364600-003        |
| 14719480                | 364200-027        |
| 440052940               | 364200-027        |
| 50020152                | 364500-009        |
| 50021437                | 364200-039        |
| 50021439                | 380030-009        |
| 50033032                | 364200-026        |
| 50050362                | 364200-026        |
| 50158345                | 364200-027        |
| 50235644                | 364200-039        |
| 50235651                | 364500-016        |
| 50236415                | 380030-009        |
| 50237043                | 364200-040        |
| 52034015                | 364200-050        |
| <b>Kalmar LMV (KM)</b>  |                   |
| 1005365                 | 364200-018        |
| 114080                  | 364500-009        |
| 119210                  | 364500-012        |
| 1316602                 | 364100-026        |
| 137769                  | 364100-006        |
| 241672                  | 364300-027        |

SERVICE SUPPLIES

# Filter Cross Reference

Kalmar Continued

| OE Number   | Crown Part Number |
|-------------|-------------------|
| 3911498     | 364300-023        |
| 3937743     | 364500-015        |
| 3991498     | 364300-023        |
| 4531050     | 364300-015        |
| 4942265     | 364100-001        |
| 4942657     | 364100-036        |
| 4948580     | 380030-124        |
| 4953804     | 380103-911        |
| 53103500    | 364100-086        |
| 800012640   | 364300-027        |
| 800033699   | 364300-017        |
| 800034641   | 364500-015        |
| 800040985   | 364300-024        |
| 807201965   | 364900-002        |
| 8761948     | 364100-014        |
| 8764816     | 380030-009        |
| 8764821     | 380030-123        |
| 8767408     | 364200-014        |
| 8775054     | 364100-015        |
| 8775086     | 364200-026        |
| 90005147    | 364500-016        |
| 90022191    | 364500-015        |
| 90023953    | 364200-045        |
| 90028099    | 364600-004        |
| 90028102    | 364500-015        |
| 90031010    | 364400-008        |
| 90031082    | 364300-023        |
| 90031133    | 364100-083        |
| 90031332    | 364300-029        |
| 90031366    | 364300-029        |
| 90031386    | 364400-008        |
| 90031422    | 364300-029        |
| 904352      | 364500-009        |
| 920040001   | 364500-009        |
| 920090001   | 364500-009        |
| 9209690035  | 364250-003        |
| 9211040001  | 364100-026        |
| 9213730003  | 364300-027        |
| 92247104500 | 364500-009        |
| 9231080699  | 364500-009        |
| 9231100577  | 364250-003        |
| 9231100578  | 364250-004        |
| 9231200407  | 364500-009        |
| 9234360720  | 364200-039        |
| 9234360721  | 380030-009        |
| 923829.0620 | 364100-083        |
| 923829.0757 | 364350-001        |
| 923829.0829 | 364300-029        |
| 9238290616  | 364100-018        |
| 9238290620  | 364100-083        |
| 9238290757  | 364350-001        |
| 923829-0757 | 364350-001        |
| 9238290829  | 364300-029        |
| 923829-0829 | 364300-029        |
| 9239441474  | 364350-001        |
| 923976.1463 | 364300-023        |
| 923976.4754 | 364500-013        |
| 923976.5327 | 364300-029        |
| 9239761463  | 364300-023        |
| 9239765327  | 364300-029        |
| 923976-5327 | 364300-029        |
| C906671     | 364400-008        |
| C907045     | 364300-029        |
| FS19616     | 364300-023        |
| HGC257002   | 364500-009        |
| LFF8062     | 364600-004        |
| LFP780      | 364500-015        |

| OE Number           | Crown Part Number |
|---------------------|-------------------|
| PEC114916           | 364100-026        |
| PEC257003           | 364100-026        |
| PFC257004           | 364100-038        |
| SHP904352           | 364500-009        |
| <b>Komatsu (KO)</b> |                   |
| 0050782             | 364950-001        |
| 0056595             | 364950-001        |
| 0064127             | 364950-001        |
| 0064128             | 364950-001        |
| 0078230             | 364950-001        |
| 0078231             | 364950-001        |
| 0090825             | 364950-001        |
| 0098025             | 364950-001        |
| 0490015             | 364200-046        |
| 0507826             | 364950-001        |
| 0565955             | 364950-001        |
| 0641276             | 364950-001        |
| 0641285             | 364950-001        |
| 0782301             | 364950-001        |
| 0782310             | 364950-001        |
| 0782318             | 364950-001        |
| 0798025             | 364950-001        |
| 0908251             | 364950-001        |
| 0908258             | 364950-001        |
| 0980250             | 364950-001        |
| 0980256             | 364950-001        |
| 1085330             | 364200-011        |
| 1-13240-122-0       | 364100-051        |
| 1-13240-160-1       | 364100-051        |
| 1-13240-168-1       | 364100-051        |
| 11421-50280         | 364200-018        |
| 1196-60-35150       | 364100-046        |
| 1240483-H1          | 364300-024        |
| 1240621-H1          | 364500-015        |
| 129150-35151        | 364100-004        |
| 15000-2300          | 364100-001        |
| 15028-65011         | 364100-005        |
| 15028-H8903         | 364100-001        |
| 15028-01B01         | 364100-014        |
| 15028-01B02         | 364100-014        |
| 15028-01B02L        | 364100-014        |
| 15028-01B0B         | 364100-014        |
| 15028-01B0BL        | 364100-014        |
| 15028-13203         | 364100-001        |
| 15028-13210         | 364100-001        |
| 15028-13211         | 364100-001        |
| 15028-13212         | 364100-001        |
| 15028-55Y00         | 364100-001        |
| 15028-65011         | 364100-005        |
| 15028-78203         | 364100-001        |
| 15028-H1010         | 364100-001        |
| 15028-H8903         | 364100-001        |
| 15028-H8904         | 364100-001        |
| 15028-H8911         | 364100-001        |
| 15028-H8916         | 364100-001        |
| 15028-H8920         | 364100-001        |
| 15028-W1103         | 364100-037        |
| 15028-W1106         | 364100-037        |
| 15028-W1120         | 364100-005        |
| 15028-W1120L        | 364100-005        |
| 15028-W1193         | 364100-005        |
| 16546-FJ170         | 364200-014        |
| 16919-W1602         | 364300-006        |
| 1894-91-1440        | 364100-065        |
| 190910-4            | 364950-001        |
| 1984-91-1440        | 364100-065        |
| 20501K1470          | 364100-026        |

| OE Number      | Crown Part Number |
|----------------|-------------------|
| 20701K1230     | 364300-027        |
| 20801K1310     | 364300-024        |
| 21P01K1390     | 364300-027        |
| 21U6-011330    | 364100-083        |
| 2276           | 364200-002        |
| 2447281        | 364200-046        |
| 244728-1       | 364200-046        |
| 29901-55850    | 364600-003        |
| 30-118         | 364200-010        |
| 30-122         | 364200-007        |
| 304-913-1021   | 364200-002        |
| 305-913-1021   | 364200-002        |
| 30C-13-11520   | 364100-075        |
| 31-103         | 364100-038        |
| 31-105         | 364100-006        |
| 3193115        | 364950-001        |
| 319311-5       | 364950-001        |
| 32670-12620-7  | 364400-001        |
| 32670-12620-71 | 364400-001        |
| 344622         | 364200-046        |
| 34-702         | 364400-001        |
| 34-900         | 364400-004        |
| 34A-02-34130   | 364200-007        |
| 34B-02-31930   | 364200-002        |
| 34B-66-15180   | 364500-004        |
| 34C-02-45140   | 364200-003        |
| 34C-02-45150   | 364200-003        |
| 37Z-02-0F201   | 364100-001        |
| 37Z-02-0F201L  | 364100-001        |
| 37Z-02-0F301   | 364100-020        |
| 37Z-02-38730   | 364200-021        |
| 37Z-02-38770   | 364200-042        |
| 37Z-02-AF931   | 364200-002        |
| 37Z-02-AF931L  | 364200-002        |
| 37Z-02-AF932   | 364200-007        |
| 37Z-02-AF935   | 364200-002        |
| 37Z-02-0F201   | 364100-001        |
| 37Z-02-0F201L  | 364100-001        |
| 37Z-02-0F201LA | 364100-001        |
| 37Z-02-0F301   | 364100-020        |
| 37Z-02-0F302   | 364100-011        |
| 3EA-01-16120   | 364200-007        |
| 3EA-01-A5390   | 364200-021        |
| 3EA-15-11600   | 364400-004        |
| 3EA-15-11610   | 364400-004        |
| 3EB-01-A5340   | 364200-002        |
| 3EB-02-34750   | 364200-010        |
| 3EB-02-38730   | 364200-021        |
| 3EB-02-63210   | 364200-050        |
| 3EB-15-31550   | 364100-008        |
| 3EB-66-11710   | 364500-003        |
| 3EB-66-11711   | 364500-003        |
| 3EB-66-11711L  | 364500-003        |
| 3EB-66-A2320   | 364500-002        |
| 3EB-76-11711   | 364500-003        |
| 3EC-01-11730   | 364200-003        |
| 3EC-01-11730L  | 364200-003        |
| 3EC-01-11738   | 364200-003        |
| 3EC-01-52590   | 380030-009        |
| 3EC-01-90015A  | 380030-123        |
| 3EC-01-90020A  | 380030-009        |
| 3EC-02-19630   | 364200-003        |
| 3EC-02-A5230   | 364200-026        |
| 3ED-66-11330   | 364100-036        |
| 3ED-66-11330L  | 364100-036        |
| 3ED-66-11331   | 364100-036        |
| 3ED-66-11331L  | 364100-036        |

| OE Number     | Crown Part Number |
|---------------|-------------------|
| 4006995       | 364300-031        |
| 4048147       | 364950-001        |
| 4048417       | 364950-001        |
| 42Y15-H0592   | D501696           |
| 4348147       | 364950-001        |
| 4394407       | 364300-031        |
| 4396645       | 364100-089        |
| 43966456      | 364100-089        |
| 4502498       | 364950-001        |
| 4502498-4     | 364950-001        |
| 4502499       | 364950-001        |
| 4502499-4     | 364950-001        |
| 4953804       | 380103-911        |
| 507826        | 364950-001        |
| 540955        | 364950-001        |
| 545240        | 364950-001        |
| 600-181-7260  | 364200-003        |
| 600-181-7280  | 364200-003        |
| 600-181-7300  | 364200-003        |
| 600-181-7600  | 364200-003        |
| 600-211-1231  | 364100-089        |
| 600-211-2110  | 364400-001        |
| 600-211-5240  | 364100-086        |
| 600-211-5241  | 364100-086        |
| 600-211-5242  | 364100-086        |
| 600-211-5520  | 364600-003        |
| 600-211-6140L | 364100-007        |
| 600-211-6141  | 364100-007        |
| 600-211-6240  | 364100-007        |
| 600-211-6241  | 364100-007        |
| 600-211-6242  | 364100-007        |
| 600-311-8140  | 364300-009        |
| 60031-18140   | 364300-009        |
| 600-311-8281  | 364300-031        |
| 600-311-8290  | 364300-031        |
| 600-311-8291  | 364300-031        |
| 600-311-8292  | 364300-031        |
| 6127-71-6090  | 364300-031        |
| 617966M       | 364950-001        |
| 6180-51-5130  | 364100-026        |
| 6610515050    | 364100-016        |
| 6610515300    | 364100-016        |
| 6732-71-6110  | 364300-027        |
| 6732-71-6111  | 364300-027        |
| 6732-71-6112  | 364300-027        |
| 6732716120    | 364300-017        |
| 6732-71-6320  | 364300-027        |
| 67355-15140   | 364500-015        |
| 6735-51-5140  | 364500-015        |
| 6735-51-5141  | 364500-015        |
| 67365-15140   | 364500-015        |
| 6736-51-5140  | 364500-015        |
| 6742-01-3790  | 364300-027        |
| 6754-71-6140  | 364300-014        |
| 6754-79-6130  | 364300-014        |
| 6754-79-6140  | 364300-014        |
| 6810-51-5130  | 364100-026        |
| 8764816       | 380030-009        |
| 8782852       | 364300-027        |
| 890321-H1     | 364200-046        |
| 8FG-123-8029A | 364100-008        |
| 91220-10500   | 364100-004        |
| 9-14219-135-1 | 364200-018        |
| AS15000-2300  | 364400-001        |
| AS15000-2300A | 364400-001        |
| AS15000-2300L | 364400-001        |
| AX58828       | 364200-046        |

**WARNING:** Cancer - [www.P65Warnings.ca.gov](http://www.P65Warnings.ca.gov)  
**Note:** More crosses available; contact your dealer.

Komatsu Continued ▶

# Filter Cross Reference

Komatsu Continued

| OE Number          | Crown Part Number |
|--------------------|-------------------|
| B4844              | 364950-001        |
| BG8129832          | 364200-039        |
| BG8876279          | 364200-039        |
| BG8925297          | 380030-009        |
| BL8619705          | 364300-003        |
| BL8690958          | 364100-020        |
| CU3315843          | 364300-024        |
| CU3903410          | 364300-017        |
| CU3903640          | 364300-027        |
| CU3931062          | 364600-004        |
| CUFF5052           | 364300-027        |
| CUF51280           | 364300-017        |
| DE48147            | 364950-001        |
| DNP13D8627         | 364300-031        |
| DTP1067            | 364300-027        |
| DUP122510          | 364200-002        |
| F3123567           | 364300-003        |
| HE0256269-00       | 364100-020        |
| HE40-0000407       | 364100-050        |
| HE40-0000415       | 364100-050        |
| L920090001         | 364500-009        |
| L9234360720        | 364200-039        |
| L9234360721        | 380030-009        |
| OKR62189           | 364100-030        |
| PK140516190        | 364100-075        |
| TJ156017600871     | 364100-011        |
| TJ15601-9600       | 364100-020        |
| TJ1560-96001       | 364100-020        |
| TJ90915-03001      | 364100-041        |
| TJ90915-03004      | 364100-041        |
| TJ90915-10002      | 364100-011        |
| TK4781-14-302      | 364100-006        |
| YM12910055650      | 364300-009        |
| YM12911055650      | 364300-009        |
| YM12915035151      | 364100-004        |
| YM12990155850      | 364600-003        |
| Z148943692993      | 364600-003        |
| Z149091403004      | 364100-011        |
| Z149091503004      | 364100-011        |
| Z760234750         | 364200-039        |
| Z760234790         | 380030-009        |
| Z76-02-38730       | 364200-021        |
| Z760238730         | 364200-021        |
| Z7602AF932         | 364200-007        |
| Z7602BX006         | 364200-010        |
| Z7602BX106         | 364200-015        |
| Z761531550         | 364100-006        |
| Z76-66-11711       | 364500-003        |
| Z766611711         | 364500-003        |
| <b>Kubota (KB)</b> |                   |
| 1521332430         | 364100-022        |
| 1521511221         | 364200-007        |
| 1522111223         | 364200-007        |
| 1522111224         | 364200-007        |
| 1522211220         | 364200-007        |
| 1522211221         | 364200-007        |
| 1522211222         | 364200-007        |
| 1522211223         | 364200-007        |
| 1522211224         | 364200-007        |
| 1522211225         | 364200-007        |
| 1522711221         | 364200-007        |
| 1522787481         | 364200-007        |
| 1523111221         | 364200-007        |
| 15241-39092        | 364100-046        |
| 1524111017         | 364200-007        |
| 1527211222         | 364200-007        |
| 1531911221         | 364200-007        |

| OE Number         | Crown Part Number |
|-------------------|-------------------|
| 1532111011        | 364200-007        |
| 1532111221        | 364200-007        |
| 1532811221        | 364200-007        |
| 1534111221        | 364200-007        |
| 15400-67900-3     | 364100-046        |
| 15400-67901-3     | 364100-046        |
| 1545143560        | 364300-003        |
| 1550111080        | 364200-007        |
| 1550111220        | 364200-007        |
| 1556211080        | 364200-007        |
| 1584132430        | 364100-008        |
| 1585211220        | 364200-007        |
| 1585399170        | 364100-065        |
| 1585399179        | 364100-065        |
| 15906-32090       | 364100-044        |
| 1609749441        | 364200-018        |
| 1627132090        | 364100-008        |
| 1921511220        | 364200-007        |
| 1923787481        | 364200-007        |
| 30401-37580       | 364100-046        |
| 38087-21000       | 364100-046        |
| 401-42270         | 364200-038        |
| 445143560         | 364300-003        |
| 6609158220        | 364200-007        |
| 66201-36161       | 364100-017        |
| 6780058300        | 364200-007        |
| 6816143610        | 364200-007        |
| 6870162190        | 364500-003        |
| 6870162192        | 364500-003        |
| 70000-14640       | 364100-052        |
| 70000-14647       | 364100-045        |
| 70000-14653       | 364100-026        |
| 70000-32050       | 364100-046        |
| 7000014671        | 364100-003        |
| 76650-25430       | 364100-046        |
| R140142270        | 364200-010        |
| RD40142270        | 364200-038        |
| TA04093230        | 364200-021        |
| Z140F-10044       | 364100-026        |
| <b>Linde (LI)</b> |                   |
| 0001160024        | 364100-032        |
| 0001160243        | 364300-027        |
| 0001174423        | 364300-027        |
| 0009830532        | 364300-029        |
| 0009830600N       | 364100-026        |
| 0009830607        | 364100-045        |
| 0009830621        | 364100-068        |
| 0009831415        | 364100-083        |
| 0009839012        | 364200-027        |
| 0009839012V       | 364200-027        |
| 009839012         | 364200-027        |
| 0160000002        | 364100-032        |
| 0312225208N       | 364100-026        |
| 1160024           | 364100-032        |
| 1174418           | 364100-032        |
| 2654403           | 364100-026        |
| 312225208         | 364100-026        |
| 56115561G         | 364100-001        |
| 68115561          | 364100-045        |
| 68115561B         | 364100-026        |
| 68115561BN        | 364100-026        |
| 68115561N         | 364100-026        |
| 7370              | 364950-001        |
| 737E03            | 364950-001        |
| 737E1             | 364950-001        |
| 7995000510        | 364100-032        |
| 9839012           | 364200-027        |

| OE Number                | Crown Part Number |
|--------------------------|-------------------|
| AE725006049              | 364100-044        |
| F9454982                 | 364500-009        |
| FM8102165                | 364100-044        |
| H17W04                   | 364100-005        |
| H17W05                   | 364100-005        |
| L0001160243              | 364300-027        |
| L0001174423              | 364300-027        |
| L0009830532              | 364300-029        |
| L0009831415              | 364100-083        |
| PC202                    | 364100-032        |
| T001005003               | 364500-009        |
| W94018                   | 364100-032        |
| XVW074115562             | 364100-068        |
| <b>Mann Filters (MV)</b> |                   |
| 45.3029292.1             | 364200-040        |
| 4530092911               | 364200-040        |
| 4530092941               | 364200-040        |
| 4920859101               | 364100-088        |
| C1176-3                  | 364200-027        |
| C14200-1                 | 364200-039        |
| C14202-1                 | 364200-039        |
| C15300                   | 364200-040        |
| C16190FR                 | 364200-041        |
| CF850                    | 380030-009        |
| CF97                     | 364200-015        |
| H1041X                   | 364950-001        |
| HU726-2X                 | 364100-068        |
| MO-101                   | 364950-001        |
| P815K                    | 364950-001        |
| P815O                    | 364950-001        |
| P915N                    | 364950-001        |
| P915R                    | 364950-001        |
| P915T                    | 364950-001        |
| P925N                    | 364950-001        |
| PF915N                   | 364950-001        |
| PF925O                   | 364950-001        |
| PF925X                   | 364950-001        |
| PF926N                   | 364950-001        |
| W12901                   | 364500-014        |
| W1374-2                  | 364500-009        |
| W7121                    | 364100-075        |
| W71210                   | 364100-075        |
| W81181                   | 364100-075        |
| W91411                   | 364100-080        |
| W91415                   | 364100-075        |
| W914-2                   | 364100-050        |
| W9144                    | 364100-080        |
| W9149X                   | 364100-075        |
| W916-1                   | 364100-050        |
| W920-12                  | 364100-020        |
| W920-21                  | 364100-020        |
| W920-23                  | 364100-020        |
| W920-26                  | 364100-020        |
| W920-70                  | 364100-020        |
| W920700                  | 364100-020        |
| W920-80                  | 364100-050        |
| W92099                   | 364100-050        |
| W930-8                   | 364100-050        |
| W9309                    | 364100-020        |
| W935-99                  | 364100-050        |
| W9407X                   | 364300-031        |
| W950-18                  | 364500-015        |
| WD930/26                 | 364500-012        |
| WF9140                   | 364100-020        |
| WF914-2                  | 364100-020        |
| WF916                    | 364100-050        |
| WF9160                   | 364100-020        |

| OE Number              | Crown Part Number |
|------------------------|-------------------|
| WF916-1                | 364100-020        |
| WF91610                | 364100-020        |
| WK719-6                | 364300-027        |
| WK757                  | 364300-027        |
| WK8122                 | 364300-032        |
| WK8129                 | 364300-032        |
| WK832                  | 364300-013        |
| WK9503                 | 364300-031        |
| <b>Mitsubishi (MB)</b> |                   |
| 0349804                | 364500-011        |
| 0363992                | 364500-009        |
| 0643736                | 364950-001        |
| 0687743                | 364200-046        |
| 0971289                | 364100-020        |
| 0971630                | 364100-023        |
| 0973352                | 380103-911        |
| 1015177                | 364400-007        |
| 1015623                | 364500-003        |
| 1032901                | 364300-015        |
| 1033660                | 364500-010        |
| 1037452                | 364400-007        |
| 1148105                | 364200-046        |
| 1157207                | 364400-007        |
| 1194740                | 364500-012        |
| 123-2367               | 364200-039        |
| 129675                 | 364600-003        |
| 1348726                | 364200-050        |
| 1383100                | 364300-032        |
| 14049960               | 364200-027        |
| 14483050               | 364500-010        |
| 1634465                | 364300-032        |
| 1767710                | 364100-051        |
| 1A3479                 | 364300-031        |
| 1N3224                 | 364500-016        |
| 1P2299                 | 364300-031        |
| 1R0711                 | 364300-031        |
| 1R0713                 | 364500-016        |
| 1R0714                 | 364200-027        |
| 1R0740                 | 364300-031        |
| 1R711                  | 364300-031        |
| 1R713                  | 364500-016        |
| 1W2638                 | 364500-016        |
| 1W8633                 | 364300-031        |
| 220900                 | 364600-003        |
| 226-6561               | 364300-024        |
| 215999                 | 364200-027        |
| 217724                 | 364200-049        |
| 218005                 | 364300-015        |
| 2W4246                 | 380030-045        |
| 30030-76800            | 364200-046        |
| 30030-76801            | 364200-046        |
| 30462-72000            | 364300-003        |
| 30630-56800            | 364200-002        |
| 30A04-00100            | 364100-004        |
| 30A40-00100            | 364100-015        |
| 30A40-00101            | 364100-015        |
| 30A40-00102            | 364100-015        |
| 30A40-00105            | 364100-015        |
| 30H30-03710            | 364200-050        |
| 311300-2300            | 364200-046        |
| 32143-00200            | 364200-007        |
| 32414-300              | 364100-046        |
| 32540-11600D           | 364100-051        |
| 32B40-00100            | 364100-033        |
| 32B40-10100            | 364100-033        |
| 32C40-00100            | 364100-006        |
| 3358                   | 364300-027        |

SERVICE SUPPLIES

**WARNING:** Cancer - [www.P65Warnings.ca.gov](http://www.P65Warnings.ca.gov)  
**Note:** More crosses available; contact your dealer.

Mitsubishi Continued ▶

# Filter Cross Reference

Mitsubishi Continued

SERVICE SUPPLIES

| OE Number    | Crown Part Number |
|--------------|-------------------|
| 34462-00300  | 364300-015        |
| 34462-01040  | 364600-003        |
| 34462-01041  | 364600-003        |
| 34462-11040  | 364600-003        |
| 34462-21040  | 364600-003        |
| 34467-21040  | 364600-003        |
| 3473004500   | 364200-046        |
| 34740-00200  | 380103-916        |
| 349804       | 364500-011        |
| 34A40-00100  | 364100-015        |
| 363992       | 364500-009        |
| 38610107     | 364200-007        |
| 3G6337       | 364500-012        |
| 3G6925       | 364500-012        |
| 3G6928       | 364500-012        |
| 3I0721       | 364500-016        |
| 3I1156       | 364950-001        |
| 3I1178       | 364300-017        |
| 3I1179       | 364300-027        |
| 3I1305       | 364300-024        |
| 3I1312       | 364300-024        |
| 3I1327       | 364500-016        |
| 3I1365       | 364300-024        |
| 3I1367       | 364300-024        |
| 3I1550       | 364200-045        |
| 3I1571       | 364200-048        |
| 3I1660       | 364300-033        |
| 3I1663       | 364500-014        |
| 3I2013       | 364200-045        |
| 3I2132       | 364300-017        |
| 3R0711       | 364300-031        |
| 40633-96     | 364100-047        |
| 4T7948       | 364500-012        |
| 50020152     | 364500-009        |
| 50021437     | 364200-039        |
| 50021439     | 380030-009        |
| 50237043     | 364200-040        |
| 51209        | 364500-012        |
| 52034015     | 364200-050        |
| 566B1405     | 364100-076        |
| 566B7177     | 364100-083        |
| 566B7290     | 364100-075        |
| 566BD7176    | 364100-074        |
| 566BF1212    | 364300-024        |
| 566BF1280    | 364300-017        |
| 566BF7681D   | 364300-032        |
| 566BF7760    | 364300-018        |
| 566BF788     | 364300-027        |
| 566BF970     | 364300-031        |
| 566BF995     | 364300-033        |
| 566BT38910   | 364500-014        |
| 566BT7237MPG | 364100-078        |
| 566BT8417    | 364500-012        |
| 566BT8454    | 364500-013        |
| 566BT8833    | 364400-009        |
| 566BW5086    | 364900-002        |
| 566PA678     | 364200-048        |
| 566RS3705    | 364200-042        |
| 566RS3745    | 364250-004        |
| 5882210072   | 364400-007        |
| 5A6717       | 364300-031        |
| 636082       | 364950-001        |
| 643736       | 364950-001        |
| 6562505300   | 364100-006        |
| 673217       | 364200-046        |
| 682994       | 364200-046        |
| 687743       | 364200-046        |

| OE Number   | Crown Part Number |
|-------------|-------------------|
| 6A5162      | 364200-027        |
| 6E0924      | 364500-012        |
| 6E0925      | 364500-012        |
| 6E924       | 364500-012        |
| 6G924       | 364500-012        |
| 6L7440      | 364300-031        |
| 6N3784      | 364300-031        |
| 6V5875      | 364500-016        |
| 77-8190     | 364500-016        |
| 7W2326      | 380103-911        |
| 817003      | 364100-075        |
| 89424-35020 | 364100-004        |
| 8L9765      | 364300-031        |
| 8N9586      | 364500-016        |
| 8N9856      | 364500-016        |
| 8T7427      | 364500-016        |
| 90425-01750 | 364100-015        |
| 90425-08220 | 364300-006        |
| 91220-10500 | 364100-004        |
| 91224-07100 | 364400-007        |
| 91224-07101 | 364400-007        |
| 91261-00040 | 364200-028        |
| 91261-00041 | 364200-028        |
| 91261-00700 | 364200-002        |
| 91261-06200 | 380100-090        |
| 91261-06700 | 364200-028        |
| 91265-09700 | 364300-006        |
| 91275-03300 | 364500-003        |
| 91275-03301 | 364500-003        |
| 91275-13000 | 364500-003        |
| 91275-13300 | 364500-003        |
| 91275-13301 | 364500-003        |
| 91375-03800 | 380030-114        |
| 91461-01500 | 364200-003        |
| 91861-01600 | 364200-041        |
| 91875-01400 | 364500-010        |
| 91875-05900 | 364500-010        |
| 91875-11400 | 364500-010        |
| 91A65-00611 | 364300-006        |
| 91B61-00112 | 364200-021        |
| 91B61-00912 | 364200-014        |
| 91K61-01700 | 380030-009        |
| 91K61-02112 | 380030-123        |
| 91K61-02300 | 380030-009        |
| 925952      | 364100-015        |
| 94611-11500 | 364200-003        |
| 971289      | 364100-020        |
| 971630      | 364100-023        |
| 9G6926      | 364500-012        |
| 9N5570      | 364500-016        |
| 9-N-5570    | 364500-016        |
| 9N9586      | 364500-016        |
| 9Y4431      | 364300-024        |
| 9Y4432      | 364300-024        |
| 9Y4464      | 364100-089        |
| 9Y4499      | 364950-001        |
| 9Y6838      | 364200-046        |
| A0000-00313 | 364100-016        |
| A0000-01339 | 364100-079        |
| A0000-02806 | 364200-008        |
| A0000-03458 | 364200-021        |
| A0000-09241 | 364500-015        |
| A0000-14210 | 364100-091        |
| A0000-14472 | 364950-001        |
| A0000-14514 | 364100-084        |
| A0000-14529 | 364200-043        |
| A0000-15358 | 364200-045        |

| OE Number    | Crown Part Number |
|--------------|-------------------|
| A0000-15983  | 364200-050        |
| A0000-15986  | 364200-047        |
| A0000-16007  | 364300-017        |
| A0000-16048  | 364300-024        |
| A0000-16115  | 364300-023        |
| A0000-16133  | 380030-009        |
| A0000-16205  | 380030-009        |
| A0000-19497  | 364200-050        |
| A0000-26444  | 380030-162        |
| A0000-26485  | 364400-006        |
| A0000-26486  | 364500-015        |
| A0000-26490  | 364400-006        |
| A0000-26588  | 380030-162        |
| A0000-26778  | 364300-032        |
| A0000-27284  | 364100-078        |
| A0000-29035  | 364200-048        |
| A0000-29038  | 364200-047        |
| A0000-29315  | 364100-083        |
| A0000-31488  | 364250-004        |
| A0000-31589  | 364500-012        |
| A0000-31655  | 364100-089        |
| A0000-36418  | 364500-015        |
| A0000-37496  | 364250-002        |
| A218869      | 364200-029        |
| A218870      | 364200-030        |
| A643736      | 364950-001        |
| AW343979     | 364100-067        |
| D001445      | 364100-004        |
| D001450      | 364100-004        |
| DO1450       | 364100-047        |
| GE924        | 364500-012        |
| K4662010     | 364100-004        |
| K4732350     | 380030-009        |
| K486201      | 364100-004        |
| K4862010     | 364100-004        |
| K4862011     | 364100-047        |
| K9665400     | 364100-046        |
| LE3ADG6926   | 364500-012        |
| LM40DQ9804   | 364500-011        |
| LM4AHN9027   | 364200-016        |
| LM4AHW2327   | 364100-005        |
| LM4AJN5504   | 364200-006        |
| LM4ODQ9804   | 364500-011        |
| M12004311    | 364200-010        |
| MD014450     | 364100-047        |
| MD-031805    | 364100-004        |
| MD129809     | 364100-030        |
| MD136466     | 364100-002        |
| MD136790     | 364100-046        |
| MD321589     | 364100-067        |
| MD332687     | 364100-002        |
| MD352626     | 364100-002        |
| MD352627     | 364100-067        |
| MD356000     | 364100-046        |
| MD365876     | 364100-002        |
| MD409365     | 364100-046        |
| ME033617     | 364200-046        |
| ME034878     | 364100-051        |
| ME060219     | 364200-046        |
| MM433093     | 364300-009        |
| MO-031805    | 364100-015        |
| TC01124      | 364100-004        |
| TM225L217    | 364950-001        |
| XD00145      | 364100-006        |
| Moffett (ZM) |                   |
| 15521-43160  | 364300-009        |
| 17321-32430  | 364100-081        |

| OE Number   | Crown Part Number |
|-------------|-------------------|
| RD401-42270 | 364200-038        |
| NAPA (NP)   |                   |
| 1010        | 364950-001        |
| 1037        | 364100-024        |
| 1040        | 364100-024        |
| 1040MP      | 364100-024        |
| 1041        | 364100-019        |
| 1042        | 364100-019        |
| 1060        | 364100-048        |
| 1064        | 364100-002        |
| 1068        | 364100-020        |
| 1069        | 364100-012        |
| 1083        | 364100-006        |
| 1084        | 364100-020        |
| 1085        | 364100-023        |
| 1085MP      | 364100-023        |
| 1191        | 364100-045        |
| 1240        | 364100-036        |
| 1243        | 364100-052        |
| 12435       | 364100-052        |
| 1243MP      | 364100-052        |
| 1248        | 364500-016        |
| 1268        | 364500-016        |
| 1288        | 364100-044        |
| 1307        | 364100-020        |
| 1311        | 364100-020        |
| 1316        | 364100-020        |
| 1334        | 364100-046        |
| 1334MP      | 364100-046        |
| 1335        | 364100-080        |
| 1344        | 364100-008        |
| 1347        | 364100-008        |
| 1348        | 364100-030        |
| 1348MP      | 364100-017        |
| 1358        | 364100-065        |
| 1372        | 364100-049        |
| 1372MP      | 364100-049        |
| 1394        | 364100-041        |
| 1395        | 364100-041        |
| 1422        | 364100-035        |
| 1453        | 364100-086        |
| 1460        | 364100-038        |
| 1516        | 364100-039        |
| 1521        | 364100-020        |
| 1522        | 364100-084        |
| 1522MP      | 364100-084        |
| 1545        | 364100-034        |
| 1568        | 364100-008        |
| 1594        | 364500-018        |
| 1602        | 364100-032        |
| 1604        | 364500-015        |
| 1607        | 364500-015        |
| 1607MP      | 364500-015        |
| 1622        | 364100-034        |
| 1626        | 364100-047        |
| 1650        | 364100-035        |
| 1663        | 364100-036        |
| 1723        | 364500-011        |
| 1734        | 364100-091        |
| 1734MP      | 364100-091        |
| 1746        | 364100-029        |
| 1759        | 364100-029        |
| 1775        | 364100-005        |
| 1785        | 364100-030        |
| 1798        | 364100-051        |
| 1806        | 364100-026        |
| 1806MP      | 364100-026        |

⚠ WARNING: Cancer - [www.P65Warnings.ca.gov](http://www.P65Warnings.ca.gov)  
 Note: More crosses available; contact your dealer.

NAPA Continued ▶

# Filter Cross Reference

NAPA Continued

| OE Number | Crown Part Number |
|-----------|-------------------|
| 1858      | 364500-009        |
| 202150    | 364100-050        |
| 2087      | 364200-049        |
| 21060     | 364100-048        |
| 21068     | 364100-050        |
| 21307     | 364100-020        |
| 21334     | 364100-046        |
| 21334MP   | 364100-046        |
| 21347     | 364100-008        |
| 21348     | 364100-017        |
| 21348MP   | 364100-017        |
| 21356     | 364100-015        |
| 21365     | 364100-065        |
| 21372     | 364100-049        |
| 21372MP   | 364100-049        |
| 21380     | 364100-047        |
| 21452     | 364100-045        |
| 21521     | 364100-037        |
| 21522     | 364100-084        |
| 21626     | 364100-047        |
| 2234      | 364200-046        |
| 22487     | 364200-043        |
| 2276      | 364200-002        |
| 23003     | 364300-034        |
| 2373      | 364200-048        |
| 2375      | 364200-048        |
| 2487      | 364200-043        |
| 2488      | 364200-043        |
| 2518      | 364200-024        |
| 26253     | 364700-002        |
| 2654033   | 364100-026        |
| 26573     | 364200-019        |
| 2803      | 364250-003        |
| 2804      | 364250-004        |
| 2868      | 364200-036        |
| 3003      | 364300-034        |
| 3033      | 364300-034        |
| 3091      | 364300-023        |
| 3192      | 364300-005        |
| 3352      | 364300-031        |
| 3356      | 364300-007        |
| 3357      | 364300-017        |
| 3357MP    | 364300-017        |
| 3358      | 364300-027        |
| 3358MP    | 364300-027        |
| 3394      | 364300-015        |
| 3405      | 364300-024        |
| 3405MP    | 364300-024        |
| 3415      | 364300-024        |
| 3431      | 364300-024        |
| 3507      | 364300-009        |
| 3528      | 364300-007        |
| 3531      | 364300-008        |
| 3535      | 364300-032        |
| 3547      | 364300-032        |
| 3548      | 364600-002        |
| 3632      | 364300-032        |
| 3637      | 364300-032        |
| 3691      | 364300-018        |
| 3777      | 364300-027        |
| 3965      | 364300-030        |
| 4112      | 364900-002        |
| 6313      | 364200-027        |
| 6433      | 364200-045        |
| 6438      | 364200-021        |
| 6439      | 364200-014        |
| 6449      | 364200-047        |

| OE Number          | Crown Part Number |
|--------------------|-------------------|
| 6483               | 364200-037        |
| 6490               | 364200-015        |
| 6562               | 364200-026        |
| 6573               | 364200-019        |
| 6652               | 364200-039        |
| 6671               | 364200-039        |
| 6672               | 380030-009        |
| 6836               | 364200-040        |
| 7025               | 364500-012        |
| 7037               | 364100-078        |
| 7092               | 364100-071        |
| 7116               | 364500-012        |
| 7181               | 364400-001        |
| 7182               | 364100-083        |
| 7210               | 364100-068        |
| 7220               | 364400-003        |
| 7411               | 364100-033        |
| 7723               | 364500-013        |
| 7740               | 364400-008        |
| M46360             | 364200-002        |
| NA-1394            | 364100-014        |
| <b>Nissan (NI)</b> |                   |
| 11720-06000        | 364100-032        |
| 15201-Z9010        | 364100-051        |
| 15208-01B01        | 364100-014        |
| 15208-01B02        | 364100-014        |
| 15208-01B10        | 364100-014        |
| 15208-01B15        | 364100-075        |
| 15208-01B0B        | 364100-014        |
| 15208-08901        | 364100-001        |
| 15208-13201        | 364100-001        |
| 15208-13213        | 364100-001        |
| 15208-29D00        | 364100-037        |
| 15208-31401        | 364100-015        |
| 15208-31U00        | 364100-015        |
| 15208-31U01        | 364100-015        |
| 15208-43G00        | 364100-005        |
| 15208-43G0A        | 364100-005        |
| 15208-65014        | 364100-005        |
| 15208-65F00        | 364100-065        |
| 15208-65F01        | 364100-065        |
| 15208-80W00        | 364100-037        |
| 15208-9C600        | 364100-020        |
| 15208-H1000        | 364100-001        |
| 15208-H1011        | 364100-001        |
| 15208-H1111        | 364100-037        |
| 15208-H8911B       | 364100-001        |
| 15208-H8923        | 364100-001        |
| 15208-H8994PC      | 364100-001        |
| 15208-W1101        | 364100-037        |
| 15208-W1103PC      | 364100-037        |
| 15208-W1120PC      | 364100-005        |
| 15208-W1123        | 364100-005        |
| 15208-W8916        | 364100-037        |
| 15208-Y9701        | 364100-026        |
| 15209-10H00        | 364100-001        |
| 15209-10H00B       | 364100-001        |
| 15209-J5602        | 364100-032        |
| 16404-78225        | 380030-124        |
| 16404-K4046        | 380030-124        |
| 16404-L1100        | 380030-124        |
| 16405-FM000        | 364600-003        |
| 16444-29000        | 364300-001        |
| 16444-99425        | 364300-031        |
| 16444-99525        | 364300-031        |
| 16546-00H03        | 364200-002        |
| 16546-00H03B       | 364200-002        |

| OE Number             | Crown Part Number |
|-----------------------|-------------------|
| 16546-00H10           | 364200-001        |
| 16546-00H10-B         | 364200-001        |
| 16546-00H10B          | 364200-001        |
| 16546-05H10           | 364200-001        |
| 16546-0K000           | 364200-001        |
| 16546-1G000           | 364200-002        |
| 165461G000            | 364200-002        |
| 16546-40K00           | 364200-033        |
| 16546-51H10           | 364200-033        |
| 16546-51H10D          | 364200-033        |
| 16546-GL11A           | 380030-123        |
| 16546-L8010           | 364200-018        |
| 16546-L9010           | 364200-018        |
| 16546Z5005            | 364200-046        |
| 16919-N7000           | 364300-006        |
| 16919-N7001           | 364300-006        |
| 16919-W1601           | 364300-006        |
| 16919-W1602           | 364300-006        |
| 17741-30510           | 364200-026        |
| 1806                  | 364100-026        |
| 20801-01361           | 364100-014        |
| 2782050               | 364100-079        |
| 2792962               | 364100-079        |
| 28719-20M1            | 364200-046        |
| 31728-11H01           | 380102-334        |
| 31728-40K00           | 380102-334        |
| 31728-FJ100           | 364400-007        |
| 41524-1060            | 364100-046        |
| 43820003              | 364100-015        |
| 53651-72061           | 364200-014        |
| 53651-72161           | 364200-014        |
| 58395-91H01           | 364100-007        |
| 58396-47601           | 364100-007        |
| 58396-47601-B         | 364100-007        |
| 58396-91H10           | 364100-007        |
| 6011-10240            | 364100-015        |
| 6032-10520            | 364100-079        |
| 6041-10220            | 364500-003        |
| 69220-6K200           | 364500-003        |
| 69220-FK100           | 380030-114        |
| 91224-07101           | 364400-007        |
| A5208-W1103           | 364100-020        |
| A5208-W1106           | 364100-020        |
| A6405-FM000           | 364600-003        |
| CK1804057             | 364100-006        |
| CK2792962             | 364100-079        |
| CK2816961             | 364100-079        |
| CK854571              | 364950-001        |
| CK918648              | 364100-002        |
| FL40399008            | 364300-031        |
| NF32B40-00100         | 364100-033        |
| NF34462-00300         | 364300-015        |
| NF90425-08220         | 364300-006        |
| NF91224-07101         | 364400-007        |
| NF91861-05600         | 364200-018        |
| NF91875-05900         | 364500-010        |
| NF91875-11400         | 364500-010        |
| NFMD352626            | 364100-002        |
| PA1690-FN             | 364200-002        |
| <b>Purolator (PU)</b> |                   |
| 30137                 | 364100-026        |
| 4611641               | 364300-031        |
| 6665973               | 364100-016        |
| 6665976               | 364100-012        |
| 6665979               | 364100-044        |
| 6665982               | 364300-031        |
| 6675008               | 364100-037        |

| OE Number | Crown Part Number |
|-----------|-------------------|
| 6675578   | 364300-031        |
| 6675582   | 364300-031        |
| 6675584   | 364300-031        |
| 6675586   | 364300-031        |
| 6675912   | 364200-003        |
| 6681138   | 364100-086        |
| 6685817   | 364300-031        |
| 6694036   | 364300-031        |
| 6694095   | 364300-002        |
| 6934761   | 364200-049        |
| 6938155   | 364500-015        |
| 9309481   | 364200-048        |
| A20055    | 364200-049        |
| A22011    | 364200-007        |
| A23496    | 364200-006        |
| A27758    | 364200-027        |
| A35167    | 364200-022        |
| A35270    | 364200-047        |
| A35300    | 364200-001        |
| A40012    | 364200-048        |
| A42019    | 364200-002        |
| A45314    | 364200-043        |
| A52040    | 364200-018        |
| A55400    | 364200-019        |
| A62044    | 364200-036        |
| A62974    | 364200-024        |
| A64699    | 364200-045        |
| A65351    | 364200-031        |
| A75173    | 364200-004        |
| AF2011K   | 364200-007        |
| AF2093    | 364100-022        |
| AF4425    | 364200-027        |
| AFP12     | 364200-048        |
| AFP55K    | 364200-049        |
| AFP69     | 364200-048        |
| EP221     | 364300-001        |
| EP221N    | 364300-001        |
| F50022    | 364300-031        |
| F50086    | 364300-001        |
| F50149    | 364300-003        |
| F50221    | 364300-001        |
| F50284    | 364300-031        |
| F54423    | 364300-017        |
| F54424    | 364300-027        |
| F54557    | 364300-009        |
| F55110    | 364300-008        |
| F55190    | 364300-032        |
| F55294    | 364300-032        |
| F55325    | 364300-005        |
| F57174    | 364300-003        |
| F57248    | 364300-001        |
| F57507    | 364300-003        |
| F57629    | 364300-003        |
| F57805    | 364300-001        |
| F57851    | 364600-003        |
| F59221    | 364300-001        |
| F60024    | 364300-024        |
| F60032    | 364300-031        |
| F60038    | 364300-031        |
| F60043    | 364300-017        |
| F60053    | 364300-031        |
| F60152    | 364300-001        |
| F60217    | 364300-001        |
| F60222    | 364600-003        |
| F60231    | 364300-031        |
| F64863    | 364300-017        |
| F65213    | 364300-031        |

**WARNING:** Cancer - [www.P65Warnings.ca.gov](http://www.P65Warnings.ca.gov)

Note: More crosses available; contact your dealer.

Purolator Continued ▶

# Filter Cross Reference

Purulator Continued

SERVICE SUPPLIES

| OE Number | Crown Part Number |
|-----------|-------------------|
| F67803    | 364300-001        |
| F70062    | 364300-031        |
| F78367    | 364300-001        |
| FC0258    | 364100-075        |
| FC101     | 364100-050        |
| FC114     | 364100-075        |
| FC1141    | 364100-075        |
| FC140     | 364100-020        |
| FC141     | 364100-075        |
| FC142     | 364100-006        |
| FC603     | 364400-002        |
| FC81      | 364400-002        |
| FCA3398   | 364100-009        |
| FCG152    | 364300-001        |
| FCO0291   | 364100-006        |
| FCO101    | 364400-002        |
| FCO160    | 364100-004        |
| FCO167    | 364100-006        |
| FCO17     | 364100-020        |
| FCO18     | 364100-020        |
| FCO201    | 364100-044        |
| FCO213    | 364100-022        |
| FCO2166   | 364100-001        |
| FCO2167   | 364100-037        |
| FCO252    | 364100-022        |
| FCO257    | 364100-045        |
| FCO28     | 364100-044        |
| FCO321    | 364100-008        |
| FCO64     | 364100-009        |
| FCO73     | 364100-008        |
| FPT750    | 364100-016        |
| FPT750B   | 364100-016        |
| FPT750H   | 364100-016        |
| GP24      | 364300-024        |
| H20294    | 364500-012        |
| H30059    | 364100-086        |
| H30135    | 364100-035        |
| H32210    | 364100-036        |
| H35235    | 364100-018        |
| H40029    | 364100-029        |
| H40175    | 364500-009        |
| HOT81     | 364100-050        |
| L10017    | 364100-020        |
| L10018    | 364100-020        |
| L10101    | 364100-050        |
| L10111    | 364100-024        |
| L10112    | 364100-024        |
| L10193    | 364100-004        |
| L14006    | 364100-019        |
| L14459    | 364100-002        |
| L14476    | 364100-041        |
| L14477    | 364100-011        |
| L14610    | 364100-015        |
| L14620    | 364100-015        |
| L14622    | 364100-015        |
| L14670    | 364100-023        |
| L17603    | 364400-002        |
| L20064    | 364100-009        |
| L20081    | 364100-050        |
| L20173    | 364100-003        |
| L20252    | 364100-022        |
| L20287    | 364100-013        |
| L22167    | 364100-037        |
| L24007    | 364100-019        |
| L24011    | 364100-003        |
| L24458    | 364100-008        |
| L24466    | 364100-022        |

| OE Number | Crown Part Number |
|-----------|-------------------|
| L25100    | 364500-012        |
| L27159    | 364100-004        |
| L27190    | 364100-022        |
| L30015    | 364100-052        |
| L30054    | 364100-007        |
| L30068    | 364100-051        |
| L30138    | 364100-038        |
| L30215    | 364500-016        |
| L30257    | 364100-045        |
| L34480    | 364100-013        |
| L34631    | 364100-048        |
| L35197    | 364100-028        |
| L37735    | 364100-068        |
| L39001    | 364100-034        |
| L44422    | 364500-015        |
| L45308    | 364100-068        |
| L60750    | 364100-016        |
| L60751    | 364100-016        |
| LI3550    | 364100-020        |
| LI3968    | 364100-023        |
| LI4117    | 364100-020        |
| LI4218    | 364100-023        |
| LX272     | 364200-027        |
| MF36300A  | 364100-020        |
| MF36304B  | 364100-020        |
| MF45800A  | 364100-020        |
| MF53400A  | 364100-023        |
| MF6103    | 364100-030        |
| MF6200A   | 364100-075        |
| MF63000   | 364100-044        |
| MF63000A  | 364100-044        |
| MF63005A  | 364100-022        |
| MFF629A   | 364300-003        |
| ML16810   | 364100-046        |
| ML16817   | 364100-065        |
| ML16819   | 364100-065        |
| OC47      | 364100-022        |
| OC49      | 364100-022        |
| P25288    | 364100-084        |
| PC20      | 364100-050        |
| PC201     | 364100-044        |
| PC200F    | 364100-044        |
| PC21      | 364100-044        |
| PC2130F   | 364100-022        |
| PC218     | 364100-020        |
| PC22      | 364100-020        |
| PC222     | 364100-007        |
| PC23      | 364100-020        |
| PC237     | 364100-026        |
| PC238     | 364100-038        |
| PC252     | 364100-022        |
| PC253     | 364100-022        |
| PC258     | 364100-075        |
| PC265     | 364100-023        |
| PC27      | 364100-020        |
| PC32      | 364100-020        |
| PC32/1    | 364100-044        |
| PC38      | 364100-020        |
| PER101    | 364100-050        |
| PER111    | 364100-024        |
| PER112    | 364100-024        |
| PER124    | 364100-019        |
| PER151F   | 364300-001        |
| PER152F   | 364300-001        |
| PER159    | 364100-004        |
| PER163    | 364100-075        |
| PER168    | 364100-044        |

| OE Number    | Crown Part Number |
|--------------|-------------------|
| PER17        | 364100-020        |
| PER170       | 364100-023        |
| PER175H      | 364500-009        |
| PER175HMIC10 | 364500-009        |
| PER179       | 364100-044        |
| PER17K       | 364100-044        |
| PER17M       | 364100-020        |
| PER18        | 364100-020        |
| PER188       | 364100-022        |
| PER190       | 364100-022        |
| PER194       | 364100-004        |
| PER211       | 364100-044        |
| PER215       | 364500-016        |
| PER2167      | 364100-037        |
| PER217F      | 364300-001        |
| PER232       | 364300-031        |
| PER241       | 364100-017        |
| PER244       | 364100-024        |
| PER247F      | 364300-001        |
| PER249F      | 364300-001        |
| PER252       | 364100-022        |
| PER257       | 364100-045        |
| PER268       | 364100-017        |
| PER270       | 364100-004        |
| PER275       | 364100-023        |
| PER276       | 364100-044        |
| PER277       | 364100-020        |
| PER28        | 364100-044        |
| PER287       | 364100-013        |
| PER289       | 364100-004        |
| PER291       | 364100-006        |
| PER294       | 364500-012        |
| PER307       | 364100-024        |
| PER321       | 364100-008        |
| PER323F      | 364300-013        |
| PER34        | 364300-031        |
| PER349       | 364100-047        |
| PER36        | 364300-031        |
| PER362       | 364100-022        |
| PER367F      | 364300-001        |
| PER37        | 364300-031        |
| PER38        | 364300-031        |
| PER393       | 364100-004        |
| PER4000      | 364100-037        |
| PER4007      | 364100-019        |
| PER4011      | 364100-003        |
| PER40M       | 364100-037        |
| PER43        | 364300-017        |
| PER4423F     | 364300-017        |
| PER4458      | 364100-008        |
| PER4459      | 364100-046        |
| PER4466      | 364100-022        |
| PER4476      | 364100-041        |
| PER4477      | 364100-011        |
| PER4619      | 364100-004        |
| PER4622      | 364100-065        |
| PER4631      | 364100-048        |
| PER4651      | 364100-049        |
| PER4670      | 364100-023        |
| PER53        | 364300-031        |
| PER58        | 364100-050        |
| PER59        | 364100-086        |
| PER62        | 364300-031        |
| PER63        | 364300-031        |
| PER-73       | 364100-006        |
| PER73        | 364100-008        |
| PER74        | 364100-008        |

| OE Number           | Crown Part Number |
|---------------------|-------------------|
| PER76               | 364300-031        |
| PER-81              | 364100-020        |
| PER81               | 364100-050        |
| PER86               | 364300-001        |
| PF3146              | 364300-003        |
| PF3174              | 364600-003        |
| PF4557              | 364300-009        |
| PIL25               | 364100-023        |
| PL129               | 364100-023        |
| PIL32               | 364100-023        |
| PL10017             | 364100-020        |
| PL10111             | 364100-024        |
| PL14006             | 364100-019        |
| PL14476             | 364100-041        |
| PL14612             | 364100-065        |
| PL14619             | 364100-047        |
| PL14622             | 364100-065        |
| PL20064             | 364100-039        |
| PL20081             | 364100-050        |
| PL20252             | 364100-022        |
| PL22167             | 364100-037        |
| PL24458             | 364100-008        |
| PL24651             | 364100-049        |
| PL25288             | 364100-084        |
| PL34631             | 364100-048        |
| PL4670              | 364100-023        |
| PM1031              | 364200-048        |
| PM1758              | 364200-027        |
| PM206A              | 364100-075        |
| PM6056              | 364500-011        |
| PMP322              | 364100-020        |
| SK221102            | 364100-026        |
| T134                | 364100-023        |
| T750                | 364100-016        |
| TB0816              | 364100-050        |
| TB0111              | 364100-024        |
| TB017               | 364100-020        |
| TB0241              | 364100-075        |
| TB081               | 364100-050        |
| <b>Raymond (RA)</b> |                   |
| 1012615-003         | 370511            |
| 1023832-003         | 370511            |
| 1024373-003         | 370511            |
| 520-509-01          | 077145            |
| 520-512             | 364100-036        |
| 520-528             | 077145            |
| 520-610             | 077145            |
| 520-610-01          | 077145            |
| 850-508             | 074105            |
| 850-516             | 074105            |
| 850-521             | 074105            |
| 850-522             | 074105            |
| 850-523             | 074105            |
| DS223161            | 074105            |
| DS232176            | 077145            |
| <b>TCM (TC)</b>     |                   |
| 112T2-52501         | 364400-001        |
| 11421-50320         | 364200-018        |
| 115G3-82241         | 364400-001        |
| 115G3-82241R        | 364400-001        |
| 12163-82301A        | 364100-006        |
| 16444-99425         | 364300-031        |
| 16444-99525         | 364300-031        |
| 1K011-43060         | 364600-003        |
| 20103361            | 364200-010        |
| 20801-01041         | 364100-001        |
| 20801-01281         | 364100-015        |

⚠ WARNING: Cancer - [www.P65Warnings.ca.gov](http://www.P65Warnings.ca.gov)

Note: More crosses available; contact your dealer.

TCM Continued ▶

# Filter Cross Reference

TCM Continued

| OE Number     | Crown Part Number |
|---------------|-------------------|
| 20801-01361   | 364100-014        |
| 20801-01431   | 364100-002        |
| 20801-02061   | 380030-124        |
| 20801-02141   | 364600-003        |
| 20801-03061   | 364200-018        |
| 20801-03081   | 364200-046        |
| 20801-03131   | 364200-002        |
| 20801-03131R  | 364200-002        |
| 20801-03132   | 364200-002        |
| 20801-03221   | 364200-003        |
| 20801-03271   | 364200-001        |
| 20801-03311   | 364200-002        |
| 20801-03351   | 364200-021        |
| 20801-03351A  | 364200-021        |
| 20801-03351R  | 364200-021        |
| 20801-03361   | 364200-050        |
| 20801-03361A  | 364200-050        |
| 20801-03511   | 364200-026        |
| 212T1-05851   | 364100-011        |
| 212T1-05851R  | 364100-011        |
| 213T1-02011   | 364200-021        |
| 214A1-02601   | 364200-003        |
| 230C1-02061   | 364200-026        |
| 23441-00422   | 364200-002        |
| 25601-08011   | 364200-021        |
| 256C1-08011   | 364200-021        |
| 256C1-08011UL | 364200-021        |
| 256G1-08011   | 364200-010        |
| 26402-37011   | 364200-026        |
| 2782050       | 364100-079        |
| 2792962       | 364100-079        |
| 513A0-52391   | 364300-006        |
| 513A0-52391   | 364300-006        |
| 89433-17480   | 364600-003        |
| 89436-91993   | 364600-003        |
| 89436-92990   | 364600-003        |
| 89436-92992   | 364600-003        |
| 89436-92993   | 364600-003        |
| A1R0750       | 364300-031        |
| AE-602950106  | 364100-008        |
| CK2792962     | 364100-079        |
| CK2816961     | 364100-079        |
| CK854571      | 364950-001        |
| DET000124     | 364200-018        |
| E602950106    | 364100-006        |
| FA3651-72061  | 364200-021        |
| FL40399008    | 364300-031        |
| N-15208-01B01 | 364100-014        |
| N-15208-13210 | 364100-001        |
| N-15208-13211 | 364100-001        |
| N-15208-13212 | 364100-001        |
| N-15208-65011 | 364100-005        |
| N-15208-65014 | 364100-005        |
| N-15208-H1000 | 364100-001        |
| N-15208-H1010 | 364100-001        |
| N-15208-H1011 | 364100-001        |
| N-15208-H8911 | 364100-001        |
| N-15208-H8916 | 364100-001        |
| N-15208-W1103 | 364100-037        |
| N-15208-W1123 | 364100-005        |
| N-16546-00H10 | 364200-001        |
| N-16546-51H10 | 364200-033        |
| N-16919-W1602 | 364300-006        |
| P-10-4972     | 364200-018        |
| P-10-5629     | 364200-002        |
| P-12-2514     | 364200-002        |
| P181054       | 364200-018        |

| OE Number           | Crown Part Number |
|---------------------|-------------------|
| T-4781-14-302       | 364100-015        |
| T-F2SM-13-Z40       | 364200-002        |
| Z8943212191         | 364100-033        |
| Z8944160690         | 364100-033        |
| Z9142-15135         | 364200-018        |
| Z-9-14215-135-1     | 364200-018        |
| <b>Tennant (TN)</b> |                   |
| 235116              | 364200-048        |
| 35254               | 364200-002        |
| 369746              | 364200-014        |
| 48127               | 364200-002        |
| 515601              | 364200-002        |
| 515601-1            | 364200-002        |
| 51561               | 364200-002        |
| 51561-1             | 364200-002        |
| 54141               | 364200-002        |
| 54141-1             | 364200-002        |
| 541414              | 364200-002        |
| 54141M              | 364200-002        |
| 55849               | 364100-008        |
| 58120               | 364200-002        |
| 10507733            | 364100-080        |
| <b>Toyota (TY)</b>  |                   |
| 00591-00111-81      | 364100-035        |
| 00591-01197-81      | 364200-024        |
| 00591-01965-81      | 364200-004        |
| 00591-02197-81      | 364200-024        |
| 00591-02570-81      | 364100-018        |
| 00591-02587-81      | 364100-079        |
| 00591-02700-81      | 364100-038        |
| 00591-03681-81      | 364100-026        |
| 00591-03688-81      | 364100-052        |
| 00591-03784-81      | 364300-017        |
| 00591-03871-81      | 364100-002        |
| 00591-03894-81      | 364200-046        |
| 00591-03998-81      | 364100-034        |
| 00591-05332-81      | 364500-012        |
| 00591-05337-81      | 364200-013        |
| 00591-05338-81      | 364200-017        |
| 00591-05449-81      | 364200-016        |
| 00591-05672-81      | 364100-006        |
| 00591-06175-81      | 364100-038        |
| 00591-06188-81      | 364100-020        |
| 00591-06344-81      | 364200-003        |
| 00591-06347-81      | 364100-080        |
| 00591-06549-81      | 364200-028        |
| 00591-06550-81      | 364200-011        |
| 00591-07056-81      | 364200-003        |
| 00591-07057-81      | 364200-002        |
| 00591-10935-81      | 364100-030        |
| 00591-11044-81      | 364100-006        |
| 00591-14062-81      | 364400-004        |
| 00591-14063-81      | 364100-036        |
| 00591-14066-81      | 364600-003        |
| 00591-14090-81      | 364500-011        |
| 00591-14820-81      | 364100-035        |
| 00591-19020-81      | 364100-005        |
| 00591-20166-81      | 364300-015        |
| 00591-20222-81      | 364500-009        |
| 00591-20312-81      | 364200-003        |
| 00591-20758-81      | 364500-004        |
| 00591-22139-81      | 364100-037        |
| 00591-22155-81      | 364200-023        |
| 00591-22159-81      | 364200-020        |
| 00591-22303-81      | 364100-041        |
| 00591-22391-81      | 364100-035        |
| 00591-27216-81      | 364200-029        |

| OE Number      | Crown Part Number |
|----------------|-------------------|
| 00591-27326-81 | 364500-003        |
| 00591-27399-81 | 364950-001        |
| 00591-27449-81 | 364100-016        |
| 00591-30483-81 | 364100-015        |
| 00591-30899-81 | 364200-033        |
| 00591-31053-81 | 364200-011        |
| 00591-31302-81 | 364100-002        |
| 00591-32747-81 | 364200-009        |
| 00591-32750-81 | 364200-002        |
| 00591-32752-81 | 364200-003        |
| 00591-32762-81 | 364100-006        |
| 00591-32763-81 | 364100-004        |
| 00591-32769-81 | 364100-037        |
| 00591-32771-81 | 364100-007        |
| 00591-32772-81 | 364200-004        |
| 00591-32776-81 | 364200-027        |
| 00591-32785-81 | 364100-035        |
| 00591-32786-81 | 364100-034        |
| 00591-32791-81 | 364200-006        |
| 00591-32795-81 | 364100-007        |
| 00591-32796-81 | 364100-006        |
| 00591-32798-81 | 364100-002        |
| 00591-32799-81 | 364100-006        |
| 00591-32800-81 | 364100-012        |
| 00591-32801-81 | 364100-035        |
| 00591-32807-81 | 364600-003        |
| 00591-32808-81 | 364200-001        |
| 00591-32810-81 | 364200-016        |
| 00591-32817-81 | 364100-003        |
| 00591-32821-81 | 364100-013        |
| 00591-32826-81 | 364200-024        |
| 00591-32827-81 | 364200-003        |
| 00591-32828-81 | 364100-006        |
| 00591-34081-81 | 364100-044        |
| 00591-34082-81 | 364100-038        |
| 00591-34092-81 | 364100-022        |
| 00591-34096-81 | 364200-046        |
| 00591-34113-81 | 364100-020        |
| 00591-34115-81 | 364100-026        |
| 00591-34131-81 | 074105            |
| 00591-34137-81 | 364500-009        |
| 00591-34138-81 | 364100-018        |
| 00591-34140-81 | 364100-001        |
| 00591-34145-81 | 364500-011        |
| 00591-34150-81 | 364500-012        |
| 00591-34151-81 | 364200-007        |
| 00591-34156-81 | 364200-024        |
| 00591-34161-81 | 364500-012        |
| 00591-34162-81 | 364200-013        |
| 00591-34165-81 | 364100-017        |
| 00591-34167-81 | 364200-028        |
| 00591-34170-81 | 364100-020        |
| 00591-34176-81 | 364100-036        |
| 00591-34177-81 | 364100-014        |
| 00591-34180-81 | 364200-017        |
| 00591-34181-81 | 364200-010        |
| 00591-34190-81 | 364400-002        |
| 00591-34191-81 | 364500-003        |
| 00591-34192-81 | 364100-015        |
| 00591-42846-81 | 364100-009        |
| 00591-42847-81 | 364200-023        |
| 00591-45311-81 | 364200-020        |
| 00591-45315-81 | 364200-021        |
| 00591-45329-81 | 364400-007        |
| 00591-50320-81 | 364200-033        |
| 00591-50593-81 | 364200-003        |
| 00591-50594-81 | 364200-001        |

| OE Number      | Crown Part Number |
|----------------|-------------------|
| 00591-50596-81 | 364200-046        |
| 00591-50598-81 | 364200-002        |
| 00591-50599-81 | 364200-009        |
| 00591-50602-81 | 364200-007        |
| 00591-50610-81 | 364100-016        |
| 00591-50614-81 | 364100-007        |
| 00591-50615-81 | 364100-001        |
| 00591-50617-81 | 364100-006        |
| 00591-50619-81 | 364100-035        |
| 00591-50623-81 | 364100-038        |
| 00591-53022-81 | 364100-013        |
| 00591-53048-81 | 364500-009        |
| 00591-53072-81 | 364500-012        |
| 00591-53079-81 | 364200-016        |
| 00591-53084-81 | 364100-018        |
| 00591-53316-81 | 364100-034        |
| 00591-53318-81 | 364100-009        |
| 00591-53498-81 | 364300-031        |
| 00591-54428-81 | 364200-028        |
| 00591-54432-81 | 364100-035        |
| 00591-54435-81 | 364200-011        |
| 00591-54436-81 | 364100-015        |
| 00591-54440-81 | 364100-017        |
| 00591-54443-81 | 364100-012        |
| 00591-54444-81 | 364100-012        |
| 00591-54446-81 | 364100-006        |
| 00591-54457-81 | 364100-006        |
| 00591-54458-81 | 364100-002        |
| 00591-54459-81 | 364100-020        |
| 00591-54465-81 | 364500-011        |
| 00591-54469-81 | 364500-012        |
| 00591-54473-81 | 077145            |
| 00591-54474-81 | 364100-020        |
| 00591-54475-81 | 364100-036        |
| 00591-54479-81 | 364500-003        |
| 00591-54481-81 | 364300-015        |
| 00591-54483-81 | 364200-010        |
| 00591-54489-81 | 364200-011        |
| 00591-54490-81 | 364100-014        |
| 00591-54491-81 | 364200-017        |
| 00591-54494-81 | 364400-002        |
| 00591-54495-81 | 364100-015        |
| 00591-59425-81 | 364100-003        |
| 00591-59433-81 | 364100-034        |
| 00591-61126-81 | 364100-035        |
| 00591-61171-81 | 364600-003        |
| 00591-62086-81 | 364200-004        |
| 00591-62213-81 | 364100-079        |
| 00591-62751-81 | 364100-029        |
| 00591-63185-81 | 364200-027        |
| 00591-63204-81 | 364100-001        |
| 00591-63387-81 | 364200-003        |
| 00591-63592-81 | 364200-049        |
| 00591-63602-81 | 364100-036        |
| 00591-63696-81 | 364100-006        |
| 00591-64106-81 | 364100-026        |
| 00591-64503-81 | 364100-002        |
| 00591-71906-81 | 364600-003        |
| 00591-72357-81 | 364100-048        |
| 00591-72359-81 | 364100-051        |
| 00591-72362-81 | 364100-089        |
| 00591-72364-81 | 364600-004        |
| 00591-72367-81 | 364300-031        |
| 00591-72368-81 | 364100-030        |
| 00591-72372-81 | 077145            |
| 00591-72387-81 | 364200-015        |
| 00591-74725-81 | 074105            |

SERVICE SUPPLIES

**WARNING:** Cancer - [www.P65Warnings.ca.gov](http://www.P65Warnings.ca.gov)

Note: More crosses available; contact your dealer.

Toyota Continued ▶

# Filter Cross Reference

Toyota Continued

| OE Number      | Crown Part Number |
|----------------|-------------------|
| 00591-76662-81 | 364400-002        |
| 00591-76870-81 | 364500-010        |
| 04234-76001-71 | 380030-124        |
| 04234-76002-71 | 380030-124        |
| 04234-76003-71 | 380030-124        |
| 08922-02001    | 364100-011        |
| 08922-02002-71 | 364100-011        |
| 08922-02004    | 364100-030        |
| 08922-02011    | 364100-041        |
| 10115-88420-71 | 364300-009        |
| 11501-01211-71 | 364100-004        |
| 11501-01390-71 | 364100-011        |
| 11501-01660-71 | 364100-011        |
| 11501-01670    | 364100-041        |
| 11531-00042-71 | 364100-037        |
| 12968-712510   | 364200-050        |
| 15600-01020-71 | 364100-011        |
| 15600-16010-71 | 364100-011        |
| 15600-20550-71 | 364100-050        |
| 15600-25010    | 364100-050        |
| 15600-39015    | 364100-009        |
| 15600-41010    | 364100-005        |
| 15600-44010    | 364100-030        |
| 15600-47011    | 364100-050        |
| 15600-49045    | 364100-050        |
| 15600-49046    | 364100-050        |
| 15600-61030    | 364100-005        |
| 15600-76003-71 | 364100-005        |
| 15600-76007-71 | 364100-050        |
| 15600-76009-71 | 364100-026        |
| 15600-76017-71 | 364100-050        |
| 15600-76018-71 | 364100-050        |
| 15601-13000-71 | 364100-037        |
| 15601-20550-71 | 364100-005        |
| 15601-20560-71 | 364100-005        |
| 15601-22010    | 364100-009        |
| 15601-33010    | 364100-009        |
| 15601-33020    | 364100-009        |
| 15601-33021    | 364100-009        |
| 15601-33022    | 364100-009        |
| 15601-33023    | 364100-009        |
| 15601-41010    | 364100-017        |
| 15601-41830    | 364100-002        |
| 15601-42160-71 | 364100-006        |
| 15601-42830-71 | 364100-004        |
| 15601-42840    | 364100-002        |
| 15601-44010-83 | 364100-017        |
| 15601-44011-83 | 364100-017        |
| 15601-68101-71 | 364100-026        |
| 15601-76001-71 | 364100-009        |
| 15601-76002-71 | 364100-017        |
| 15601-76003-71 | 364100-017        |
| 15601-76005    | 364100-011        |
| 15601-76007-71 | 364100-011        |
| 15601-76008-71 | 364100-011        |
| 15601-76009-71 | 364100-075        |
| 15601-78001-71 | 364100-020        |
| 15601-87305-71 | 364100-013        |
| 15601-87310    | 364100-008        |
| 15601-96001    | 364100-050        |
| 15601-96101    | 364100-020        |
| 15601-U2120-71 | 364100-012        |
| 15601-U2120-F  | 364100-012        |
| 15611-31720-71 | 364100-003        |
| 17702-23470-71 | 364200-008        |
| 17702-30750-71 | 364200-018        |
| 17702-42500-71 | 364200-010        |
| 17703-23470-71 | 364200-008        |
| 17704-30710-71 | 364200-018        |

| OE Number      | Crown Part Number |
|----------------|-------------------|
| 17712-96395-71 | 364200-002        |
| 17731-41830-71 | 364200-007        |
| 17741-13600-71 | 364200-008        |
| 17741-23600-71 | 364200-008        |
| 17741-30510-71 | 364200-026        |
| 17741-98333-71 | 364200-008        |
| 17741-F9860-71 | 364200-008        |
| 17741-U1100-71 | 364200-008        |
| 17741-U2100-71 | 364200-010        |
| 17741-U3330-71 | 364200-026        |
| 17742-32850-71 | 364200-008        |
| 17743-23600-71 | 364200-008        |
| 17743-98333-71 | 364200-008        |
| 17743-F9860-71 | 364200-008        |
| 17743-U1100-71 | 364200-008        |
| 17744-U2230-71 | 380030-154        |
| 17752-20540-71 | 364200-003        |
| 17791-11120-71 | 364200-002        |
| 17792-22000-71 | 364200-003        |
| 17801-15010-71 | 364100-009        |
| 17801-23000-71 | 364200-003        |
| 17801-23001-71 | 364200-003        |
| 17802-23000-71 | 364200-003        |
| 17802-23001-71 | 364200-003        |
| 17802-U2020-71 | 364200-003        |
| 17803-U2050-71 | 364200-003        |
| 17803-U2051-71 | 364200-003        |
| 17808-23800-71 | 364200-020        |
| 23303-30370-71 | 364200-003        |
| 23303-76002-71 | 380030-158        |
| 23323-42830-71 | 364300-009        |
| 25310-34950-71 | 380030-124        |
| 32150-40840-71 | 364100-017        |
| 32623-12620-71 | 364100-044        |
| 32623-20570-71 | 364100-017        |
| 32670-12620-71 | 364400-001        |
| 32760-12620-71 | 364400-001        |
| 32901-31630-71 | 380030-164        |
| 40150-30370-71 | 364100-020        |
| 67502-13300-71 | 380030-129        |
| 67502-20540-71 | 380030-164        |
| 67502-23000-71 | 380030-163        |
| 67502-26600-71 | 380030-245        |
| 67502-U2230-71 | 380030-245        |
| 67532-42800-71 | 364100-018        |
| 78520-30200    | 364100-034        |
| 80915-76010-71 | 364100-030        |
| 80915-76012-71 | 364100-011        |
| 80915-76024-71 | 364100-030        |
| 89220-2005     | 364100-041        |
| 90080-91034    | 364100-041        |
| 90080-91058    | 364100-041        |
| 90915-03001    | 364100-041        |
| 90915-03002    | 364100-030        |
| 90915-03004    | 364100-041        |
| 90915-03005    | 364100-030        |
| 90915-10001    | 364100-041        |
| 90915-10002    | 364100-011        |
| 90915-10004    | 364100-011        |
| 90915-20001    | 364100-030        |
| 90915-20002    | 364100-076        |
| 90915-20003    | 364100-030        |
| 90915-20004    | 364100-001        |
| 90915-TA001    | 364100-041        |
| 90915-YZZA1    | 364100-011        |
| 90915-YZZA2    | 364100-041        |
| 90915-YZZB9    | 364100-017        |

| OE Number                   | Crown Part Number |
|-----------------------------|-------------------|
| 90915-YZZD1                 | 364100-017        |
| 90915-YZZD9                 | 364100-041        |
| 90915-YZZF1                 | 364100-011        |
| 90915-YZZF2                 | 364100-041        |
| C0120-00013                 | 364100-041        |
| VM52739001                  | 364100-026        |
| <b>WIX/Air Refiner (WX)</b> |                   |
| 10FP                        | 364950-001        |
| 13                          | 364100-019        |
| 15                          | 364100-020        |
| 22                          | 364100-024        |
| 24                          | 364100-019        |
| 24112                       | 364900-002        |
| 25442                       | 364200-028        |
| 26                          | 364100-022        |
| 3119                        | 364100-023        |
| 318P                        | 364100-023        |
| 319P                        | 364100-023        |
| 321P                        | 364100-009        |
| 322P                        | 364100-023        |
| 33033                       | 364300-034        |
| 33091                       | 364300-023        |
| 330P                        | 364100-023        |
| 33118                       | 364300-002        |
| 33128                       | 364600-003        |
| 33166                       | 364300-003        |
| 33192                       | 364300-005        |
| 33340                       | 364300-031        |
| 33352                       | 364300-031        |
| 33352MP                     | 364300-031        |
| 33356                       | 364300-007        |
| 33357                       | 364300-017        |
| 33357MP                     | 364300-017        |
| 33358                       | 364300-027        |
| 33358MP                     | 364300-027        |
| 33362                       | 364300-031        |
| 33373                       | 364300-001        |
| 33394                       | 364300-015        |
| 333P                        | 364100-023        |
| 33405                       | 364300-024        |
| 33405MP                     | 364300-024        |
| 33407                       | 364300-004        |
| 33415                       | 364300-024        |
| 33431                       | 364300-024        |
| 33441                       | 364300-024        |
| 33507                       | 364300-009        |
| 33528                       | 364300-007        |
| 33531                       | 364300-008        |
| 33535                       | 364300-032        |
| 33547                       | 364300-032        |
| 33548                       | 364600-002        |
| 335P                        | 364100-044        |
| 33632                       | 364300-032        |
| 33637                       | 364300-032        |
| 33691                       | 364300-018        |
| 33777                       | 364300-027        |
| 342P                        | 364100-023        |
| 345P                        | 364100-023        |
| 347P                        | 364100-008        |
| 350P                        | 364100-023        |
| 42083                       | 364250-003        |
| 42087                       | 364200-049        |
| 42126                       | 364200-018        |
| 42180                       | 364200-025        |
| 42222                       | 364200-003        |
| 42234                       | 364200-046        |
| 42276                       | 364200-002        |

| OE Number | Crown Part Number |
|-----------|-------------------|
| 42338     | 364200-018        |
| 42370     | 364200-009        |
| 42373     | 364200-048        |
| 42375     | 364200-048        |
| 42487     | 364200-043        |
| 42488     | 364200-043        |
| 42518     | 364200-024        |
| 42598     | 364700-001        |
| 42645     | 364200-007        |
| 42804     | 364250-004        |
| 42806     | 364200-008        |
| 42868     | 364200-036        |
| 46142     | 364200-004        |
| 46232     | 364200-006        |
| 46233     | 364200-016        |
| 46253     | 364700-002        |
| 46262     | 364200-001        |
| 46309     | 364200-022        |
| 46313     | 364200-027        |
| 46433     | 364200-045        |
| 46434     | 364200-013        |
| 46438     | 364200-021        |
| 46438FR   | 364200-014        |
| 46439     | 364200-014        |
| 46449     | 364200-047        |
| 46480     | 364200-020        |
| 46483     | 364200-037        |
| 46489     | 364200-010        |
| 46490     | 364200-015        |
| 46513     | 364200-011        |
| 46562     | 364200-026        |
| 46567     | 364200-024        |
| 46569     | 364200-031        |
| 46573     | 364200-019        |
| 46614     | 364100-043        |
| 46652     | 364200-039        |
| 46671     | 364200-039        |
| 46672     | 380030-009        |
| 46836     | 364200-040        |
| 49020     | 364200-036        |
| 49021     | 364250-002        |
| 51010     | 364950-001        |
| 51036     | 364100-003        |
| 51037     | 364100-024        |
| 51040     | 364100-024        |
| 51040MP   | 364100-024        |
| 51041     | 364100-019        |
| 51042     | 364100-019        |
| 51050     | 364100-016        |
| 51060     | 364100-048        |
| 51064     | 364100-046        |
| 51068     | 364100-050        |
| 51068MP   | 364100-050        |
| 51069     | 364100-012        |
| 51083     | 364100-006        |
| 51084     | 364100-020        |
| 51085     | 364100-023        |
| 51085MP   | 364100-023        |
| 51088     | 364100-022        |
| 51182     | 364100-013        |
| 51191     | 364100-045        |
| 51194     | 364500-005        |
| 51208     | 364500-016        |
| 51243     | 364100-052        |
| 51243MP   | 364100-052        |
| 51261     | 364100-007        |
| 51268     | 364500-016        |

**WARNING:** Cancer - [www.P65Warnings.ca.gov](http://www.P65Warnings.ca.gov)

Note: More crosses available; contact your dealer.

WIX/Air Refiner Continued ▶



# Filter Cross Reference

WX/Air Refiner Continued

| OE Number | Crown Part Number |
|-----------|-------------------|
| 51268MP   | 364500-016        |
| 51288     | 364100-044        |
| 51307     | 364100-020        |
| 51311     | 364100-020        |
| 51312     | 364100-020        |
| 51316     | 364100-020        |
| 51319     | 364100-020        |
| 51334     | 364100-046        |
| 51334MP   | 364100-046        |
| 51335     | 364100-080        |
| 51338     | 364100-008        |
| 51339     | 364100-075        |
| 51342     | 364100-022        |
| 51344     | 364100-008        |
| 51345     | 364100-001        |
| 51348     | 364100-030        |
| 51348MP   | 364100-017        |
| 51356     | 364100-015        |
| 51362     | 364100-020        |
| 51372     | 364100-049        |
| 51372MP   | 364100-049        |
| 51376     | 364100-051        |
| 51380     | 364100-008        |
| 51381     | 364100-004        |
| 51391     | 364100-017        |
| 51393     | 364100-022        |
| 51394     | 364100-041        |
| 51395     | 364100-041        |
| 51396     | 364100-011        |
| 51422     | 364100-035        |
| 51452MP   | 364100-045        |
| 51453     | 364100-086        |
| 51455     | 364100-018        |
| 51460     | 364100-038        |
| 51515     | 364100-005        |
| 51516     | 364100-039        |
| 51521     | 364100-037        |
| 51522     | 364100-084        |
| 51522MP   | 364100-084        |
| 51545     | 364100-034        |
| 51568     | 364100-008        |
| 51594     | 364500-018        |
| 51602     | 364100-032        |
| 51604     | 364500-015        |
| 51607     | 364500-015        |
| 51607MP   | 364500-015        |
| 51622     | 364100-034        |
| 51626     | 364100-047        |
| 51650     | 364100-035        |
| 51663     | 364100-036        |
| 51723     | 364500-011        |
| 51725     | 364100-033        |
| 51734     | 364100-091        |
| 51734MP   | 364100-091        |
| 51746     | 364100-029        |
| 51759     | 364100-029        |
| 51798     | 364100-051        |
| 51806     | 364100-026        |
| 51806MP   | 364100-026        |
| 51858     | 364500-009        |
| 51873     | 364100-089        |
| 533091    | 364300-023        |
| 533352    | 364300-031        |
| 542118    | 364200-046        |
| 542338    | 364200-018        |
| 546313    | 364200-027        |
| 546438    | 364200-021        |

| OE Number        | Crown Part Number |
|------------------|-------------------|
| 546439           | 364200-014        |
| 546449           | 364200-047        |
| 546483           | 364200-037        |
| 546490           | 364200-015        |
| 546652           | 364200-039        |
| 546671           | 364200-039        |
| 546672           | 380030-009        |
| 551268           | 364500-016        |
| 551338           | 364100-008        |
| 551362           | 364100-020        |
| 551394           | 364100-041        |
| 551522           | 364100-084        |
| 551607           | 364500-015        |
| 551626           | 364100-047        |
| 557025           | 364500-012        |
| 557085           | 364100-044        |
| 557210           | 364100-068        |
| 57025            | 364500-012        |
| 57037            | 364100-078        |
| 57060            | 364100-031        |
| 57085            | 364100-044        |
| 57092            | 364100-071        |
| 57094            | 364100-014        |
| 57116            | 364500-012        |
| 57181            | 364400-001        |
| 57182            | 364100-083        |
| 57210            | 364100-068        |
| 57243            | 364100-028        |
| 57451            | 364500-010        |
| 57723            | 364500-013        |
| 59116            | 364100-065        |
| 59181            | 364300-015        |
| A112             | 364200-027        |
| CA415            | 364100-023        |
| CW10             | 364950-001        |
| CW243MP          | 364100-052        |
| CW452MP          | 364100-045        |
| CW453MP          | 364100-086        |
| CW84MP           | 364100-020        |
| DT1246           | 364200-018        |
| DT87             | 364200-049        |
| PC307P           | 364100-020        |
| PC311P           | 364100-020        |
| PC312P           | 364100-020        |
| PC316            | 364100-020        |
| PC319P           | 364100-023        |
| WA10316          | 364200-053        |
| <b>Yale (YT)</b> |                   |
| 014049960        | 364200-027        |
| 044052940        | 364200-027        |
| 063193600        | 364950-001        |
| 066457800        | 364200-002        |
| 066457900        | 364200-003        |
| 119005-35100     | 364100-008        |
| 119660-35150     | 364100-046        |
| 124085-35111     | 364100-008        |
| 129087-12510     | 364200-021        |
| 1327905          | 380103-911        |
| 138662100        | 364950-001        |
| 138662101        | 364950-001        |
| 140499600        | 364200-027        |
| 150011600        | 364100-050        |
| 150012700        | 364200-002        |
| 150012800        | 364200-003        |
| 150017200        | 364100-020        |
| 150017600        | 364100-006        |
| 150023100        | 364200-002        |

| OE Number | Crown Part Number |
|-----------|-------------------|
| 150127002 | 364600-004        |
| 190886001 | 364500-003        |
| 220000637 | 364500-009        |
| 220001862 | 364100-018        |
| 220002418 | 364100-007        |
| 220002486 | 074105            |
| 220002487 | 364200-004        |
| 220003608 | 364200-041        |
| 220004261 | 364100-001        |
| 220004522 | 364200-016        |
| 220005321 | 364100-001        |
| 220006163 | 364300-031        |
| 220006165 | 364100-079        |
| 220006498 | 364100-037        |
| 220007093 | 364100-001        |
| 220007906 | 364300-031        |
| 220007907 | 364200-046        |
| 220007910 | 364100-034        |
| 220007911 | 364500-016        |
| 220007914 | 364200-046        |
| 220010432 | 364200-027        |
| 220016046 | 364100-002        |
| 220016442 | 364100-022        |
| 220017036 | 364200-010        |
| 220018074 | 364100-014        |
| 220018224 | 364300-027        |
| 220018365 | 364200-020        |
| 220018642 | 364200-023        |
| 220019061 | 364100-008        |
| 220020159 | 364200-041        |
| 220020426 | 074105            |
| 220020474 | 074105            |
| 220021422 | 364100-004        |
| 220021672 | 364100-006        |
| 220021873 | 364100-012        |
| 220021874 | 364100-034        |
| 220021883 | 364200-033        |
| 220022271 | 077145            |
| 220023301 | 364200-041        |
| 220023404 | 364500-015        |
| 220023405 | 364300-017        |
| 220023427 | 364100-002        |
| 220023954 | 364200-011        |
| 220024174 | 364100-014        |
| 220024667 | 364100-009        |
| 220025201 | 364100-037        |
| 220025232 | 364200-003        |
| 220026447 | 364300-015        |
| 220027050 | 364100-018        |
| 220028173 | 364200-014        |
| 220028667 | 364200-002        |
| 220031787 | 364100-017        |
| 220036196 | 364200-008        |
| 220036199 | 364600-003        |
| 220036241 | 364400-001        |
| 220036509 | 364100-011        |
| 220037602 | 364200-010        |
| 220040677 | 364100-017        |
| 220042480 | 364500-015        |
| 220042484 | 364300-017        |
| 220042965 | 364200-002        |
| 220043605 | 364100-012        |
| 220043748 | 364500-012        |
| 220044119 | 364100-002        |
| 220044765 | 364200-015        |
| 220049713 | 364300-032        |
| 220049758 | 364500-018        |

| OE Number | Crown Part Number |
|-----------|-------------------|
| 220052149 | 364100-006        |
| 220052452 | 364100-005        |
| 220054022 | 364600-003        |
| 220054026 | 364200-001        |
| 220054027 | 364300-015        |
| 220054030 | 364200-002        |
| 220054033 | 364200-003        |
| 220070304 | 364600-003        |
| 220070365 | 364500-011        |
| 220070367 | 364200-006        |
| 220070371 | 077145            |
| 220070380 | 364100-044        |
| 220070490 | 364500-012        |
| 220070555 | 364100-030        |
| 220070633 | 364200-001        |
| 220071699 | 364200-007        |
| 220072541 | 364100-003        |
| 220073924 | 364400-009        |
| 220074151 | 364500-009        |
| 220075007 | 364300-003        |
| 220075012 | 364100-016        |
| 220075013 | 364100-020        |
| 220075018 | 364100-026        |
| 220075022 | 364100-038        |
| 220075033 | 364200-003        |
| 220075043 | 364200-002        |
| 220075112 | 364100-020        |
| 220075116 | 077145            |
| 220079879 | 364200-017        |
| 220088276 | 364100-044        |
| 220102404 | 364200-010        |
| 249999000 | 364200-002        |
| 249999001 | 364100-006        |
| 249999002 | 364100-016        |
| 249999003 | 364200-003        |
| 249999004 | 364100-001        |
| 249999005 | 364100-004        |
| 249999006 | 364100-013        |
| 249999007 | 364100-050        |
| 249999008 | 364100-026        |
| 249999019 | 364100-026        |
| 249999021 | 364100-007        |
| 249999022 | 364100-026        |
| 249999023 | 077145            |
| 249999024 | 364500-012        |
| 249999025 | 364200-001        |
| 249999026 | 364100-009        |
| 249999027 | 364100-038        |
| 249999028 | 364100-015        |
| 249999030 | 364100-006        |
| 249999031 | 364200-041        |
| 249999032 | 364200-010        |
| 249999033 | 364200-013        |
| 249999034 | 364200-009        |
| 249999035 | 364200-006        |
| 249999037 | 364300-015        |
| 249999038 | 364100-002        |
| 249999039 | 364200-011        |
| 249999040 | 364100-037        |
| 3122275   | 364200-023        |
| 330035194 | 364200-027        |
| 330035556 | 364100-032        |
| 440052940 | 364200-027        |
| 440054069 | 364100-026        |
| 440054600 | 364100-038        |
| 44052940  | 364200-027        |
| 461015223 | 364100-032        |

SERVICE SUPPLIES

**WARNING:** Cancer - [www.P65Warnings.ca.gov](http://www.P65Warnings.ca.gov)

Note: More crosses available; contact your dealer.

Yale Continued ▶

## Filter Cross Reference

Yale Continued

| OE Number | Crown Part Number |
|-----------|-------------------|
| 500138800 | 364950-001        |
| 500139800 | 364950-001        |
| 502903501 | 077145            |
| 504025100 | 364200-018        |
| 504240863 | 364200-003        |
| 504297790 | 364100-012        |
| 504449744 | 074105            |
| 505676800 | 364200-018        |
| 505960559 | 364100-006        |
| 505966578 | 364100-020        |
| 505973580 | 380030-128        |
| 506973401 | 364200-018        |
| 507640800 | 364200-018        |
| 513498801 | 364100-034        |
| 515133806 | 364100-038        |
| 515133851 | 364300-003        |
| 515133856 | 364100-038        |
| 5151413   | 364100-005        |
| 515141300 | 364100-005        |
| 515303801 | 364100-035        |
| 5158648   | 364200-003        |
| 515864800 | 364200-003        |
| 515865800 | 364200-002        |
| 515935800 | 364100-016        |
| 516042852 | 364300-003        |
| 517584860 | 364100-038        |
| 5194548   | 364100-050        |
| 519454800 | 364100-050        |
| 520045030 | 364200-015        |
| 524136754 | 380103-911        |
| 524148312 | 364500-019        |
| 580002784 | 364200-018        |
| 580004421 | 364300-001        |

| OE Number | Crown Part Number |
|-----------|-------------------|
| 580007144 | 364100-034        |
| 580008852 | 364100-026        |
| 580010991 | 380030-123        |
| 580031871 | 364500-015        |
| 580042635 | 364300-023        |
| 580048839 | 380030-064        |
| 580052153 | 380030-162        |
| 580056944 | 380030-068        |
| 580058663 | 364500-015        |
| 580058807 | 364500-015        |
| 580069337 | 364250-001        |
| 580074341 | 364100-083        |
| 580088196 | 364250-002        |
| 582002947 | 380030-162        |
| 582005334 | 380030-162        |
| 582034868 | 364100-092        |
| 582036738 | 364100-081        |
| 66457800  | 364200-002        |
| 751287402 | 364100-035        |
| 800058909 | 159792-001        |
| 800071711 | 364100-034        |
| 800130449 | 380030-162        |
| 800135439 | 370511            |
| 800142220 | 364250-002        |
| 900001224 | 380030-047        |
| 900006282 | 364100-003        |
| 900291828 | 364100-006        |
| 900506400 | 364100-034        |
| 900506401 | 364100-034        |
| 900533802 | 364100-008        |
| 900538802 | 364100-008        |
| 900546802 | 364200-003        |
| 900770802 | 364100-032        |

| OE Number   | Crown Part Number |
|-------------|-------------------|
| 900907800-E | 364600-003        |
| 900907804   | 364600-003        |
| 900907810   | 364600-003        |
| 900907811   | 364600-003        |
| 901030815   | 364100-008        |
| 901091803   | 364200-003        |
| 901277817   | 364200-002        |
| 901281813   | 364200-065        |
| 901301815   | 364100-008        |
| 901397803   | 364200-003        |
| 901515400   | 364200-002        |
| 901517400   | 364100-006        |
| 901544400   | 364500-003        |
| 901870801   | 364200-003        |
| 901992850   | 364200-002        |
| 902166802   | 364200-021        |
| 902225300   | 364200-002        |
| 902255802   | 364200-010        |
| 902426801   | 364200-026        |
| 902489801   | 364200-042        |
| 904788100   | 364100-020        |
| 905332600   | 364100-036        |
| 905332601   | 364100-036        |
| 907160600   | 364100-036        |
| 907160601   | 364100-036        |
| 907172400   | 364100-020        |
| 910361400   | 364100-020        |
| 910544400   | 364500-003        |
| 910545401   | 380102-349        |
| 917380400   | 364500-010        |
| 927788400   | 364100-020        |
| 1018296     | 364700-004        |

SERVICE SUPPLIES

## Section 2

# Safety Equipment

### Contents

|   |      |
|---|------|
| Seat Belts  | 2.02 |
| Mirrors   | 2.02 |
| Harnesses   | 2.03 |
| Lanyards/Accessories  | 2.05 |
| Maintenance Safety Items  | 2.06 |
| Eye/Hearing/Breathing/Face Protection   | 2.07 |
| Shoe Covers   | 2.10 |
| Safety Apparel  | 2.11 |
| Hard Hats   | 2.12 |
|  Wall Signs | 2.13 |
| Safety Related Accessories  | 2.13 |
| Spill Cleanup Products  | 2.15 |
| First Aid Kits  | 2.16 |

### New Items:

KN95 Mask - p. 2.09  
Disposable Mask - p. 2.09  
Reusable Mask - p. 2.09  
Knit Cap with LED Light - Orange - p. 2.12  
Wall Signs - p. 2.13

Note: 1910.178(q)(5) (1998) of the Occupational Safety and Health Act (OSHA) requires that "All parts of any such industrial truck requiring replacement shall be replaced only by parts equivalent as to safety with those used in the original design."

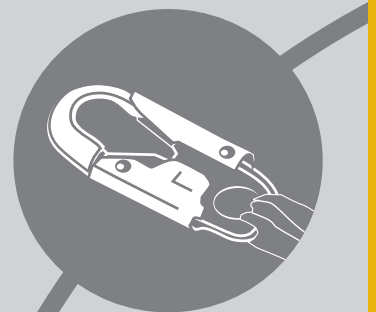

## Seat Belts

### Seat Belts

| Part Number | Part Number Black | Part Number w/ Interlock Switch | Type                    | Retractor Style | Belt Width | Belt Length | Dim. A | Dim. B | Includes U-shaped Bracket |
|-------------|-------------------|---------------------------------|-------------------------|-----------------|------------|-------------|--------|--------|---------------------------|
| 122003-002  | 122003            |                                 | Retractable, Anti-cinch | "Y"             | 2"         | 50"         | 4"     | 11.50" | X                         |
| 122016-002  | 122016            |                                 | Retractable, Anti-cinch | "Y"             | 2"         | 50"         | 4"     | 9.60"  |                           |
| 132257-002  | 132257            |                                 | Retractable, Anti-cinch | "Z"             | 2"         | 54"         | 8.50"  | 10.50" | X                         |
| 132252-002  | 132252            | 132252-003                      | Retractable, Anti-cinch | "Z"             | 2"         | 54"         | 8.50"  | 10.50" |                           |
| 163519-002  | 163519-001        | 163519-003                      | Retractable, Anti-cinch | "X"             | 2"         | 51"         | 5.50"  | 10.50" |                           |
| 300000      | NA                |                                 | Retractable             | "Y"             | 2"         | 50"         | 4"     | 11.50" | X                         |

**WARNING:** Cancer and reproductive harm - [www.P65Warnings.ca.gov](http://www.P65Warnings.ca.gov)

**Note:** Mounting hardware included. Seat belts meet requirements of SAE J386 and FMVSS 302.

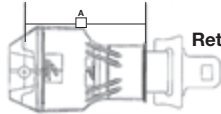

Retractor "X"

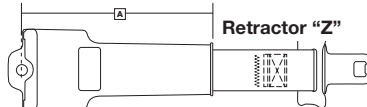

Retractor "Z"

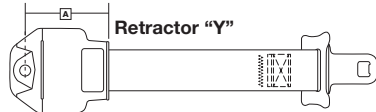

Retractor "Y"

U-Shaped Bracket

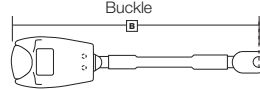

Buckle



## Mirrors

| Part Number | Dimensions W x L (in) | Description   |
|-------------|-----------------------|---|
| 111481      | 4.44 x 5.75           | Bolts on with 1/4"-20 UNC nut                           |
| 094723      | 5.65 x 8.65           | Bolts on with 1/4"-20 UNC nut                           |
| 137670      | 7.32 x 12.52          | Mounts onto .55" - .79" (14-20 mm) diameter rod         |
| 105035      | 6.00 x 23.00          | Flat mirror, no mounting                                |
| 105036      | 6.00 x 23.00          | Includes mirror (P.N. 105035) and machined cover mount. |
| 148613      | 4.50 x 8.00           | Plastic mirror, bolts on with 3/8" UNC nut              |
| 151007      | 6.37 diameter         | Round acrylic lens                                      |

**WARNING:** Cancer and reproductive harm - [www.P65Warnings.ca.gov](http://www.P65Warnings.ca.gov)



111481



094723



137670



148613



105035



151007



Part Number - 380030-006

### Mirror

4" x 7.875"

▼ OEM Reference

TY 58710-20540-71



Part Number - 380030-007

### Mirror

3.875" x 6.25"

▼ OEM Reference

HM 7395

NI 96303-11H00



Part Number - 380030-044

### Mirror

4.625" x 8"

▼ OEM Reference

HM 7390 NI 96303-6G000  
KM 4966092 TY 58720-23320-71  
KO 3EB-55-13571 TY 58720-26600-71



300130-001

### Anti-Blind Spot Dome Mirrors

These plastic mirrors give a complete 180° view, allowing the operator to give a quick safety check before traveling in reverse. Installs on any lift truck in seconds with either two-sided tape or a magnet.



300130-002

Part Number - 300130-001

3M two-sided tape;  
8.5" x 6.25" x 3"

Part Number - 300130-002

Magnet; 8.25" x 7.5" x 3"



Part Number - 380030-168

### Mirror

4.625" x 8"

▼ OEM Reference

TY 58720-23000-71



Part Number - 305001

### Mirror

5.5" x 7.5"

Hardware: 1/4" - 20 x 7/16" L

**WARNING:** Cancer - [www.P65Warnings.ca.gov](http://www.P65Warnings.ca.gov)

## Personal Fall Protection System Configurations (lbs.)

| Fall Protection / Prevention Device       | Operator Weight (lbs.) |                      |                   | Contact Truck Manufacturer |
|---|------------------------|----------------------|-------------------|----------------------------|
|   | <311 <sup>1</sup>      | 311-400 <sup>1</sup> | >400 <sup>1</sup> |                            |
| Full Body Harness                         | X                      | X                    | X                 |                            |
| Energy Absorber - max total length (6ft.) | X                      |                      |                   |                            |
| Self Retracting Lanyard                   |                        | X                    | X <sup>2</sup>    |                            |
| Maximum Arresting Force Permitted (lbs)   | 1800                   | 1800                 | 1800              |                            |

1) Truck Capacity shall be reduced by the operator(s) weight in excess of 220 lbs.  
 2) Self Retracting Lanyard - shall be rated for the operator's weight. Contact Truck Manufacturer.

**Note:** ANSI standards B56.1 (4.17). Standards effective Feb. 23, 2013.



**Full Body Harness with Mating Buckle**

| Part Number | Size          |
|-------------|---------------|
| 300001-004  | X-Small       |
| 300001-001  | Small/Medium  |
| 300001-002  | Large/X-Large |
| 300001-003  | XX-Large      |

- Lightweight nylon webbing
- Permits unrestricted movement
- Lightweight and durable
- Forged-steel sliding back D-ring
- Mating buckles on legs and shoulder straps



**Full Body Harness with D-ring Web Extension**

| Part Number | Size         |
|-------------|--------------|
| 300030-001  | Small/Medium |
| 300030-002  | Universal    |
| 300030-003  | XXL          |

- Stretchable webbing design
- Unique D-ring web extension
- Lanyard ring
- For warehouse pickers



**Full Body Harness with Tongue Buckle**

| Part Number | Size          |
|-------------|---------------|
| 300002-001  | Small/Medium  |
| 300002-002  | Large/X-Large |
| 300002-003  | XX-Large      |
| 300002-004  | XXX-Large     |

- Conventional nylon webbing
- Friction buckles on chest and shoulder straps
- Tongue buckle leg straps
- Forged steel sliding back D-ring
- Permits unrestricted movement



**Full Body Harness with Tongue Buckle**

| Part Number | Size          |
|-------------|---------------|
| 128775      | Large/X-Large |

- Friction buckle shoulder strap adjustment
- Tongue buckle leg strap adjustment
- Forged steel sliding back D-ring
- Mating chest strap buckle
- Sub pelvic strap
- Pull-free lanyard ring
- Non-stretch webbing

| Part Number | Capacity (lbs.) | Sliding Back D-Ring | Side D-Rings | Shoulder Strap Buckles* | Leg Strap Buckles* | Chest Strap Buckle* | Sub-Pelvic Strap | Pull-Free Lanyard Rings | Stretchable Webbing | Manufacturer | Shoulder & Leg Padding Removable |
|-------------|-----------------|---------------------|--------------|-------------------------|--------------------|---------------------|------------------|-------------------------|---------------------|--------------|----------------------------------|
| 300001-XXX  | 400             | Yes                 | No           | M                       | M                  | M                   | Yes              | Yes                     | No                  | Titan        | No                               |
| 300002-XXX  | 400             | Yes                 | No           | M                       | T                  | M                   | Yes              | Yes                     | No                  | Titan        | No                               |
| 128775-XXX  | 400             | Yes                 | No           | F                       | T                  | M                   | Yes              | Yes                     | No                  | Miller       | No                               |
| 300030-XXX  | 400             | Yes                 | No           | F                       | M                  | M                   | Yes              | Yes                     | Yes                 | Miller       | No                               |

\*Key: F-Friction; M-Mating; T-Tongue

### Harness Size Reference Chart

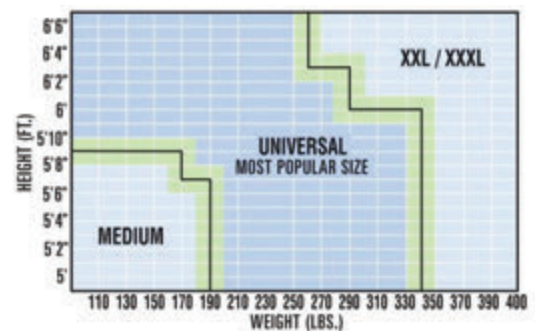

# Fall Protection - Harnesses



### AirCore Full Body Harness with Aluminum Hardware

- Corrosion resistant aluminum hardware
- Breathable, open-core padding technology
- Stretchable webbing provides flexibility and comfort
- Cam buckles on the shoulder straps for easy adjustments
- Universal (Large/X-Large)

| Part Number | Side D-Rings | Chest Strap Buckle | Leg Strap Buckles | Lumbar Pad | Removable Belt |
|-------------|--------------|--------------------|-------------------|------------|----------------|
| 300031-050  | No           | Quick-Connect      | Tongue            | No         | No             |
| 300031-051  | No           | Quick-Connect      | Quick-Connect     | No         | No             |
| 300031-052  | Yes          | Quick-Connect      | Tongue            | No         | No             |
| 300031-053  | Yes          | Quick-Connect      | Quick-Connect     | No         | No             |
| 300031-054  | Yes          | Quick-Connect      | Tongue            | Yes        | Yes            |



### AirCore Full Body Harness with Steel Hardware

- Breathable, open-core padding technology
- Stretchable webbing provides flexibility and comfort
- Cam buckles on the shoulder straps for easy adjustments
- Universal (Large/X-Large)

| Part Number | Side D-Rings | Chest Strap Buckle | Leg Strap Buckles | Lumbar Pad | Removable Belt |
|-------------|--------------|--------------------|-------------------|------------|----------------|
| 300031-010  | No           | Quick-Connect      | Quick-Connect     | No         | No             |
| 300031-011  | No           | Quick-Connect      | Tongue            | No         | No             |
| 300031-012  | Yes          | Quick-Connect      | Quick-Connect     | No         | No             |
| 300031-013  | Yes          | Quick-Connect      | Tongue            | No         | No             |
| 300031-014  | Yes          | Quick-Connect      | Quick-Connect     | Yes        | Yes            |
| 300031-015  | Yes          | Quick-Connect      | Tongue            | Yes        | Yes            |
| 300031-016  | No           | Mating Buckle      | Tongue            | No         | No             |
| 300031-017  | Yes          | Mating Buckle      | Tongue            | Yes        | Yes            |



### Harness with Trauma Strap Universal/Large

Part Number 353601

No-tangle design. Includes trauma strap. Stand-up back D-ring. Tongue buckle leg straps. Repel™ webbing. Built-in lanyard keepers. Revolver™ vertical torso adjusters. Impact Indicator. Protected labels, equipped with i-Safe™.

### Harness Size Reference Chart

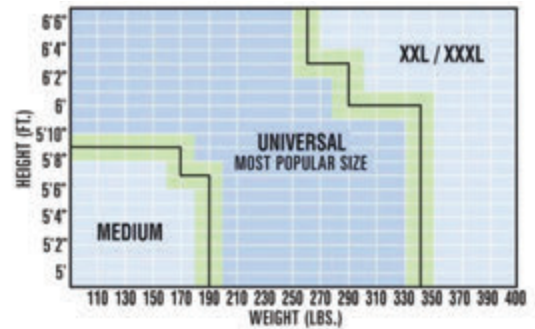

### Trauma Strap

Part Number 353603

Suspension trauma safety strap. Allows user to stand in harness after a fall. Attaches to almost any harness. Fast and easy installation. Extremely compact and lightweight design. Simple and fast zipper style deployment. Continuous loop design. In-field re-settable design.

## Fall Protection - Lanyards



### Universal Cab Mount 8 ft. Fall Limiter Assembly

| Part Number | Length (ft) | Weight Capacity (lb) |
|-------------|-------------|----------------------|
| 300052      | 8           | 310                  |

#### Cab Mount

- Adjustable side brackets promotes a custom fit from 3.75" to 9.125"
- Quick and easy installation
- Non-protruding mount provides greater head room

#### Fall Limiter

- Capacity 310 lbs, can add 300020-001 shock absorbing pack for capacity of 400 lbs
- Quick-activating, high-strength stainless steel braking system

### Fall Limiter (Only)

| Part Number | Description            | Size (ft) |
|-------------|------------------------|-----------|
| 300052-001  | For use with Cab Mount | 8         |



### Lanyard Energy-Absorbing

| Part Number | Length (ft) | Weight Capacity (lb) |
|-------------|-------------|----------------------|
| 129935-001  | 6           | 310                  |

Orange - locking snap hooks on each end. Add P.N. 300020-001 energy absorbing pack for capacity of 400 lbs.



### Lanyard Self-Retracting

| Part Number | Length (ft) | Weight Capacity (lb) | Color |
|-------------|-------------|----------------------|-------|
| 153557      | 8           | 310                  | Red   |

Small, lightweight design. Quick-activating, high-strength stainless steel breaking system - arrest free falls. Visual load indicator - indicates the unit must be removed from service.



### Energy-Absorbing Pack

| Part Number | Description  |
|-------------|--|
| 300020-001  | Add to P.N. 153557 or 129935-001 for a weight limit capacity of 400 lbs. |



### Lanyard Self-Retracting

| Part Number | Length (ft) | Weight Capacity (lb) | Color |
|-------------|-------------|----------------------|-------|
| 353600      | 8           | 400                  | Red   |

Extremely compact and lightweight. High-impact nylon housing and abrasion-resistant webbing. Snap hook w/aluminum body and steel gate. Stainless steel ball bearing swivel.



### Turbo Lite - Personal Fall Limiter

| Part Number | Length (ft) | Weight Capacity (lb) |
|-------------|-------------|----------------------|
| 300028      | 6           | 400                  |

Unit Connector: Steel Twist-Lock Carabiner. Lanyard End Connector: ANSI Z359-2007 Compliant Locking Snap Hook. Extremely compact and lightweight, comparable to a shock-absorbing lanyard. Attaches directly to the back D-ring of a harness for increased mobility. High-impact nylon housing and abrasion-resistant webbing provide long service life. Integral swivel prevents lifeline from twisting.



### Retractable Lanyard U-Bolt Swivel

Part Number H53622-531  
6 ft. (1.8m) 3/4" (19mm) Dyneema® fiber and polyester web lifeline. Swiveling self-locking snap hook on lifeline. Extremely compact, lightweight design. Tough and impact resistant thermoplastic housing. Swiveling anchorage loop. Quick activating speed sensing brake system. High capacity external energy absorber and impact indicator. i-Safe™ equipped.

## Fall Protection - Accessories



### Carabiners Turn Open Lock

| Part Number | Gate |
|-------------|------|
| 300064      | 3/4" |
| 300006      | 1"   |

# Maintenance Safety Items <sup>(^Not for operator use on lift truck)</sup>

SAFETY EQUIPMENT



### Self-Retracting Lifeline<sup>^</sup>

| Part Number | Length (ft) | Weight Capacity (lb) |
|-------------|-------------|----------------------|
| 300067      | 11          | 310                  |
| 300058      | 20          | 310                  |
| 300068      | 50          | 310                  |
| 300069      | 66          | 310                  |
| 300070      | 85          | 310                  |

- Industry's lightest and most compact SRL.
- Unique speed-sensing brake reduces clearance requirements and limits fall arrest forces to 900 lbs or less.

<sup>^</sup>Note: Not for operator use on lift truck.



### 3' Tie-off Adaptor<sup>^</sup>

| Part Number | Length (ft) | Weight Capacity (lb) |
|-------------|-------------|----------------------|
| 300059      | 3           | 310                  |

- 1 1/4" polyester strength member, 5000 lb minimum tensile strength.
- 3" wide polyester wear pad for added abrasion resistance.

<sup>^</sup>Note: Not for operator use on lift truck.



### Tag Line<sup>^</sup>

| Part Number | Length (ft) |
|-------------|-------------|
| 300060      | 25          |

- 3/8" polypropylene rope with o-ring at end used to tie to end of self retracting lifelines to bring end down to the user.

<sup>^</sup>Note: Not for operator use on lift truck.



### Storage Bag<sup>^</sup>

| Part Number | Size (in)       |
|-------------|-----------------|
| 300066      | 24W x 12H x 12D |

Used to store and carry harnesses, lanyards, tag lines, etc.

<sup>^</sup>Note: Not for operator use on lift truck.

**WARNING:** Cancer and reproductive harm - [www.P65Warnings.ca.gov](http://www.P65Warnings.ca.gov)



### Carabiners Turn Open Lock

| Part Number | Gate |
|-------------|------|
| 300064      | 3/4" |
| 300006      | 1"   |



### Lanyard Positioning<sup>^</sup>

| Part Number | Length (ft) | Weight Capacity (lb) |
|-------------|-------------|----------------------|
| 300063      | 6           | 310                  |

1" wide web built in wear indicator informs user when to replace self-locking snap hooks at both ends.

<sup>^</sup>Note: Not for operator use on lift truck.



### ExoFit XP Harness with back and side D-rings

- Soft lightweight polyester webbing is strong without feeling stiff
- Soft edging prevents rubbing and chafing
- Unique spring loaded "stand-up" dorsal D-ring ensures fast, easy and safe connections and safe D-rings for work positioning
- Coated hardware for corrosion resistance
- Washable with removable padding

| Part Number | Size | Capacity (lbs.) | Sliding Back D-Ring | Side D-Rings | Shoulder Strap Buckles** | Leg Strap Buckles** | Chest Strap Buckle** | Sub-Pelvic Strap | Stretchable Webbing | Shoulder & Leg Padding Removable |
|-------------|------|-----------------|---------------------|--------------|--------------------------|---------------------|----------------------|------------------|---------------------|----------------------------------|
| 300082      | S    | 420             | Yes                 | Yes          | M                        | M                   | M                    | Yes              | No                  | Yes                              |
| 300056      | M    | 420             | Yes                 | Yes          | M                        | M                   | M                    | Yes              | No                  | Yes                              |
| 300057      | L    | 420             | Yes                 | Yes          | M                        | M                   | M                    | Yes              | No                  | Yes                              |
| 300071      | XL   | 420             | Yes                 | Yes          | M                        | M                   | M                    | Yes              | No                  | Yes                              |
| 300072      | XXL  | 420             | Yes                 | Yes          | M                        | M                   | M                    | Yes              | No                  | Yes                              |

\*\*Key: M-Mating

### ▲ ExoFit XP Harness Accessories

#### Storage Pouch

| Part Number | Description  |
|-------------|--|
| 300061      | Two belt loops for easy attachment to your belt and harness. Velcro closure to secure items. Size: 7" x 9" x 3". |



#### Cell Phone Pouch

| Part Number | Description         |
|-------------|---------------------|
| 300062      | Attaches to harness |



### Ratchet Strap<sup>^</sup>

| Part Number | Length (ft) |
|-------------|-------------|
| 300136      | 6           |

- 1" wide strap
- Work load limit 500 lbs.
- Breaking strength 1,500 lbs.

<sup>^</sup>Note: Not for operator use on lift truck.



# Eye Protection



### Safety Glasses\*

| Part Number | Sales Unit |
|-------------|------------|
| 365285-012  | Case of 12 |



Crown logo branded - printed on right lens. Soft integrated nose piece. Lightweight and 9.75 base curve lens provides excellent side protection. Soft dual injected rubber temple tips provide non-slip comfort. Scratch resistant polycarbonate lens provides 99% UVA/B/C protection. Conforms with ANSI Z87.1.



### OTG Safety Glasses\*

| Part Number | Sales Unit |
|-------------|------------|
| 365286-012  | Case of 12 |



Crown logo - printed on right side shield. One piece lightweight safety glass lens. Adjustable temples and extended brow guard. Over glasses design. Polycarbonate impact resistant lens with 99.9% UVA/UVB protection. Conforms with ANSI Z87.1 + standards.



### Safety Glasses\*

| Part Number | Sales Unit |
|-------------|------------|
| 365250-012  | Case of 12 |

Economical protection. Full coverage. Frost color frame, clear lens. Wraparound style, lightweight. Conforms with ANSI Z87.1.



### Safety Glasses\*

| Part Number | Sales Unit |
|-------------|------------|
| 365251-012  | Case of 12 |

Soft padding on temple arm tip and padded nose bridge. Black frame, clear lens. Adjustable temple arm. Wraparound style, durable frame. Conforms with ANSI Z87.1.



### Safety Glasses\*

| Part Number | Sales Unit |
|-------------|------------|
| 365252-012  | Case of 12 |

Wraparound Hi-Vis Green design for maximum field of vision. Padded nose bridge. Adjustable temple arm. Hi-Vis Green retainer cord. Conforms with ANSI Z87.1.



### Safety Glasses\*\*

| Part Number | Description                                    |
|-------------|--|
| 363200-008  | Safety Glasses - Amber Lens with Amber Temples |
| 363200-010  | Safety Glasses - Amber Lens with Black Temples |

\*\*Available for all customers



### Safety Glasses\*

| Part Number | Sales Unit |
|-------------|------------|
| 365254-012  | Case of 12 |

OTG basic eyewear protection for visitors. Economical. Clear frame, clear lens, fits over glasses. ANSI approved Z87.1.



### Premium Anti-fog Safety Glasses\*

| Part Number | Sales Unit |
|-------------|------------|
| 365287-012  | Case of 12 |



H2X anti-fog protection from fogging in humid environments. Scratch resistant. Dielectric. Rubber temple tips and nose piece. Single wraparound lens. Conforms with ANSI Z87.1+, CAN/CSA Z94.3 standards.



### Standard Anti-fog Safety Glasses\*\*

| Part Number | Sales Unit |
|-------------|------------|
| 365279-012  | Case of 12 |



Anti-fog coating for protection from fogging in humid environments. Scratch resistant. Earplug retaining technology. Hollowed out, lightweight frame for maximum air flow. Bynaonet temple for greater comfort. Conforms with ANSI Z87, CAN/CSA Z94.3 standards.

\*\*Available for all customers



### Goggles\*

| Part Number | Sales Unit |
|-------------|------------|
| 365253-012  | Case of 12 |



For complete eye protection where splash or heavy particles are in the air. Full face flange allows for comfort while the polycarbonate lens give full protection. With Anti-Fog lenses and indirect ventilation. Conforms with ANSI Z87 safety standard.



### +1.5 Reading Lens\*

| Part Number | Sales Unit |
|-------------|------------|
| 365256      | Single     |



Strategic placement of lens insert is out of user's direct line of vision. 100% Polycarbonate scratch resistant lenses. Nose buds secure the glass & prevent slipping, adjustable temple arm. Provides 99% protection from harmful UL UV-A & UV-B rays. Exceeds ANSI Z87.1 high impact requirements & CE EN166 certified.



### I-Force Goggles\*

| Part Number | Sales Unit |
|-------------|------------|
| 365257      | Single     |



Sporty, lightweight design. Quick release interchangeable temples & elastic strap. Anti-fog, clear lens. Exceeds ANSI/ISEA Z87.1 standards.



### Pre-Moistened Towelettes\*

| Part Number | Sales Unit    |
|-------------|---------------|
| 365255      | 10 boxes/case |

5" x 8", 100 to a box. NOT for use on coated lenses. For glasses and computer screens. Individual packages for convenience and portability.

\*Available only to customers in USA

## Eye Wash Products



### 16 Gallon Eye Wash Station\*

| Part Number | Sales Unit |
|-------------|------------|
| 365466      | 1 kit      |

Size: 20.5" length, 18" width, 20.5" height. 15 minute flow, required by ANSI Z358.1-2009. Includes steel wall bracket, 2 oz. sterile water solution, and test log and drainage hose. Drain and refill every 4 months with 2 oz. solution, part number 365474.



### Replacement Bottle of Eye Wash\*

| Part Number | Sales Unit        |
|-------------|-------------------|
| 365469-001  | One 16 oz. bottle |

Sterile eye wash. Can be used alone or with 365468 eyewash station.



### Water Additive\*

| Part Number | Sales Unit           |
|-------------|----------------------|
| 365474      | 8 oz. bottle/12 case |

Add to water for 16 gallon eye wash station to eliminate contamination from stagnant water. 8 oz. per 16 gallon refill.



### Eye Wash Station\*

| Part Number | Sales Unit |
|-------------|------------|
| 365468      | 1 kit      |

Two bottle wall-mounted eye wash station. Includes two 16 oz bottles of sterile eye wash. Easily mounts to any wall.

## Hearing Protection



### Ear Plugs\*

| Part Number | Sales Unit    |
|-------------|---------------|
| 365280-200  | 200 pairs/box |

NRR 33. Officially licensed ear plugs of NASCAR®. Tapered for easy insertion in any ear canal. Different colors in every package. Individually wrapped. 1 pair per bag.



### Ear Muffs for Hard Hat\*

| Part Number | Sales Unit |
|-------------|------------|
| 365283      | Single     |

Low profile design. Soft foam ear cups. Adjustable to fit all sizes. Fold-away padded headband. Meets ANSI S3.19 requirements, CE EN 352-2-2002 certification, NRR 34.

**WARNING:** Cancer - [www.P65Warnings.ca.gov](http://www.P65Warnings.ca.gov)



### Ear Plugs\*

| Part Number | Sales Unit |
|-------------|------------|
| 365281-100  | 100/box    |

NRR 33. Officially licensed ear plugs of NASCAR®. Tapered for easy insertion in any ear canal. Different colors in every package. Individually wrapped. 1 pair per bag. With cord.



### Electronic Ear Muff - Sport\*\*

| Part Number | Sales Unit |
|-------------|------------|
| 300148      | Single     |

NRR 22 dB. Canada Class B. Built-in directional microphones amplify range commands and other ambient sounds to a safe 82dB. Impact Sport actively listens and automatically compresses amplification when ambient impact sound reaches 82dB, and passively blocks out noise at 22dB. Amplifies low-level sound up to 4 times. Low energy-consuming 4-hour automatic shut-off. Connects to iPod, MP3 and other devices. Patented Air-Flow Control Technology. Camouflage. Soft headband. Folds for convenient storage. Protection against harmful noise.

\*\*Available for all customers



### Ear Plugs - Multiple Use\*\*

| Part Number | Sales Unit    |
|-------------|---------------|
| 300152-100  | 100 pairs/box |

Soft no roll-down foam with flexible stem and dimpled tip reduces hygiene concerns and collapses to be easily inserted into the ear. The ergonomically contoured paddle fits naturally between the finger and thumb, even while wearing work gloves. Reusable, unrecorded. Convenient carrying case. Noise reduction rating of 28; orange; one size fits most.

\*\*Available for all customers



### Ear Muffs\*

| Part Number | Sales Unit |
|-------------|------------|
| 365282      | Single     |

Low profile design. Soft foam ear cups. Adjustable to fit all sizes. Fold-away padded headband. Meets ANSI S3.19 requirements, CE EN 352-2-2002 certification, NRR 34.

**WARNING:** Cancer and reproductive harm - [www.P65Warnings.ca.gov](http://www.P65Warnings.ca.gov)

\*Available only to customers in USA



### Electronic Ear Muff - Pro\*\*

| Part Number | Sales Unit |
|-------------|------------|
| 300149      | Single     |

NRR 30 dB. Canada Class A(L). Strategically placed directional stereo microphones to amplify ambient sounds, including alarms/warning signals, and conversations while suppressing (not muting) loud, impact noises down to a safe level of 82dB. Sound amplification allows wearers to hear important communication - alarms/warning signals, co-workers' voices. Quick-Click height adjustment remains fixed during wear. More comfortable padded headband. All-in-one up and down, on/off and volume control. Snap-in ear cushions make replacement quick. Features 3.5mm audio jack and cable for connection to personal listening devices.

\*\*Available for all customers

# Breathing Protection



## Moldex 9000 Reusable Full-Face Respirator\*

| Part Number | Sales Unit |
|-------------|------------|
| 365274      | Single     |

Provides lung and face protection. Lightweight. Strap buckles are securely molded to face piece for rugged use. Coated lens for scratch resistance. Size: Large. NIOSH approved.



## Protective Sheets for Face Shield\*

| Part Number | Sales Unit    |
|-------------|---------------|
| 365274-001  | 15 sheets/box |

For use on full-face respirator (P.N. 365274) to protect face piece.



## Moldex N95 Particulate Pre-Filter\*

| Part Number | Sales Unit  |
|-------------|-------------|
| 365275      | 5 pair/pack |

Use with vapor cartridge or stand alone. NIOSH certified.



## Respirator Mask w/Exhale Valve\*

| Part Number   | Sales Unit   |
|---------------|--------------|
| 365271-010-02 | 2 boxes/case |

Protects against ultra-fine particles. Inner soft foam nose cushion. Metal-free. Blue color-coded double straps. With exhale valve. NIOSH approved, N95. 10/box.

SUPPLIES  
MAY BE  
LIMITED



## Moldex® 2300 N95 Particulate Respirator\*

| Part Number   | Sales Unit |
|---------------|------------|
| 365277-010-01 | 10/box     |

Dura-Mesh shell for durability. Protects against fine, dry particles. Softspun inner liner for comfort; molded nose bridge. Blue/white. Size: medium/large. NIOSH approved. With exhale valve.

SUPPLIES  
MAY BE  
LIMITED



## Nuisance Mask\*

| Part Number   | Sales Unit   |
|---------------|--------------|
| 365272-050-04 | 4 boxes/case |

For dirt, dust and nuisance cleaning. Single strap and metal nose piece. Not NIOSH approved. 50/box.



## Particulate Respirator\*

| Part Number   | Sales Unit |
|---------------|------------|
| 365289-020-01 | 20/box     |

N95 approved filtering particulate respirator. Adjustable nose clip reduces potential for eyewear fogging and helps ensure a better seal and fit. Two straps help provide a secure fit.

SUPPLIES  
MAY BE  
LIMITED



## Respirator Mask\*

| Part Number   | Sales Unit   |
|---------------|--------------|
| 365270-020-02 | 2 boxes/case |

Protects against ultra-fine particles. Inner soft foam nose cushion. Metal-free. Yellow color-coded double straps. NIOSH approved, N95. 20/box.

SUPPLIES  
MAY BE  
LIMITED



## KN95 Mask\*

| Part Number | Sales Unit |
|-------------|------------|
| 365295-050  | 50/box     |

Filters up to 95% of particles with 5-layer construction. Non-medical, ear loop style with adjustable nose clip. Fits comfortably to the face and provides respiratory protection against particles. Regulated by the Chinese government under GB2626-2006.

NEW!



## Disposable Mask\*\*

| Part Number | Sales Unit |
|-------------|------------|
| 365294      | 50/box     |

Unique 4-fold design forms a better cone shape to provide maximum coverage. 3-ply construction; ear loop style. Masks are 100% latex and fiber glass free. Inner layer is ultra soft and comfortable on the skin. Metal free plastic nose bridge conforms to wearer's face for a comfortable fit. Meets ASTM F2100-11 requirements as Performance Level 2 Barrier medical face mask. Color blue.

\*\*Available for all customers

NEW!



## Reusable Mask\*\*

| Part Number | Sales Unit |
|-------------|------------|
| 365297-005  | 5/pack     |

3-ply, 100% machine washable cotton jersey; 100% cotton fabric touching skin; three evenly spaced pleats on each side. 3.5 in height at side, 5 in. height at center front, 7 in width. Comfortable elastic ear loops help hold the mask in place. Color black.

\*\*Available for all customers

NEW!



## Moldex 7000 Reusable Half-Mask\*\*

| Part Number | Sales Unit |        |
|-------------|------------|--------|
| 365273      | Large      | Single |
| 365273-001  | Medium     | Single |

Totally adjustable. Lightweight. Fits under welding helmets & with safety glasses. NIOSH approved. Includes face piece, 2 organic vapor cartridges, retainer and 2 prefilters.

\*\*Available for all customers

SUPPLIES  
MAY BE  
LIMITED



## Organic Vapor Cartridges\*

| Part Number | Sales Unit  |
|-------------|-------------|
| 365276      | 1 pair/pack |

Protection against organic vapors. Use with half-mask respirator (P.N. 365273) or full-face respirator (P.N. 365274).

## Disposable Respirator\*

| Part Number | Sales Unit |        |
|-------------|------------|--------|
| 365288-001  | Medium     | Single |
| 365288-002  | Large      | Single |

Organic Vapor and P95 respiratory protection. Maintenance free; OV cartridges permanently attached and individually packed. Includes a bonus hygiene guard and shape retainer insert. Applications include paint spray applications, including oil based paints.

\*Available only to customers in USA

## Face Protection



### Face Mask\*

| Part Number | Sales Unit |
|-------------|------------|
| 365258      | Single     |

Full face protection, fits over prescription glasses. Removable shield. Exceeds ANSI Z87.1 high-impact requirements. CE EN166 certified. Exceeds CAN/CSA Z94.3-07 standards.



### Universal Hard Hat Adapter\*

| Part Number | Sales Unit |
|-------------|------------|
| 365262      | Single     |

For use with face shields.



### Polyethylene Face Shield (only)\*

| Part Number | Sales Unit |
|-------------|------------|
| 365263      | Single     |

8" x 15" x .040" thick. Meets ANSI Z87.1 requirements; CSA Z94.1-05. Headgear is separate.



### Polycarbonate Face Shield (only)\*

| Part Number | Sales Unit |
|-------------|------------|
| 365264      | Single     |

8" x 15" x .040" thick. Meets ANSI Z87.1 requirements; CSA Z94.1-05. Headgear is separate.



### Disposable Tear-Off Visor\*

| Part Number | Sales Unit |
|-------------|------------|
| 365259      | 6/pack     |

Full face protection.



### Headgear for Face Shield\*

| Part Number | Sales Unit |
|-------------|------------|
| 365261      | Single     |

Constructed from durable nylon. Universal pegs will accommodate a wide variety of face shields. Ratchet style adjustment for easy fit. Pivoting action allows user to lift face shield while wearing.



### Face Shield\*\*

| Part Number | Sales Unit |
|-------------|------------|
| 323016      | Single     |

3M Ratchet Headgear with Faceshield. Features polycarbonate construction to provide high clarity. Ideal for heavy-duty impact and heat-resistance applications.

\*\*Available for all customers

\*Available only to customers in USA

## Shoe Covers



### Open Toe Overshoes\*\*

| Part Number | Size                                       |
|-------------|--|
| 366207-001  | Small (Mens: 5.0-8.5; Womens: 7.0-9.5)     |
| 366207-002  | Medium (Mens: 9.0-11.0; Womens: 10.0-11.5) |
| 366207-003  | Large (Mens: 11.5-12.0; Womens: 12.0+)     |
| 366207-004  | Extra Large (Mens: 13.0-16.5)              |

Slides over most shoe types. Great when transitioning from shop to office to keep carpets clean.

\*\*Available for all customers



### Premium Shoe Covers\*

| Part Number | Description  |
|-------------|--|
| 365301-240  | 60 pair/box; 2 boxes/case. Polypropylene coated with polyethylene for extreme durability. Non-slip texture offers support and grip on any floor surface. Wide elastic opening. X-Large size. Non-linting; latex and silicone free. Durable dispensing box. |



### Shoe Covers\*

| Part Number | Description  |
|-------------|--|
| 365301-300  | Non-skid bottom. Polypropylene. Elastic around ankles. X-Large. 150 pairs. |

\*Available only to customers in USA

**Breakaway Safety Vests\*\***



| Size    | Crown Branded Part Number        |
|---------|----------------------------------|
| Small   | 365314-000-01-C                  |
| Medium  | 365314-001-01-C                  |
| Large   | 365314-002-01-C                  |
| X-Large | 365314-003-01-C                  |
| 2XL     | 365314-004-01-C                  |
| 3XL     | 365314-005-01-C                  |
| 4XL     | 365314-006-01-C                  |
| 5XL     | 365314-007-01-C                  |
| 6XL     | 368100-008-01 (pockets may vary) |



100% polyester mesh, hi-vis green. Sold individually. 5 point breakaway, shoulders, sides and front closure. Closure: velcro. 2" silver tape reflective material -1 horizontal stripe. Pockets: 1 lower right inside, 1 upper left outside. 3rd party certified, meets ANSI/ISEA 107-2015, Class 2 Type R standards.

\*\*Available for all customers

**Breakaway Safety Vests\***



| Size    | Orange Mesh   | Orange Solid  |
|---------|---------------|---------------|
|         | Part Number   | Part Number   |
| Small   | 365312-000-01 | 365313-000-01 |
| Medium  | 365312-001-01 | 365313-001-01 |
| Large   | 365312-002-01 | 365313-002-01 |
| X-Large | 365312-003-01 | 365313-003-01 |
| 2XL     | 365312-004-01 | 365313-004-01 |
| 3XL     | 365312-005-01 | 365313-005-01 |
| 4XL     | 365312-006-01 | 365313-006-01 |
| 5XL     | 365312-007-01 | 365313-007-01 |



| Size    | Green Mesh    | Green Solid   |
|---------|---------------|---------------|
|         | Part Number   | Part Number   |
| Small   | 365314-000-01 | 365315-000-01 |
| Medium  | 365314-001-01 | 365315-001-01 |
| Large   | 365314-002-01 | 365315-002-01 |
| X-Large | 365314-003-01 | 365315-003-01 |
| 2XL     | 365314-004-01 | 365315-004-01 |
| 3XL     | 365314-005-01 | 365315-005-01 |
| 4XL     | 365314-006-01 | 365315-006-01 |
| 5XL     | 365314-007-01 | 365315-007-01 |

100% polyester mesh/solid, hi-vis orange/green. Sold individually. 5 point breakaway, shoulders, sides and front closure. Closure: velcro. 2" silver tape reflective material -1 horizontal stripe. Pockets: 1 upper and lower left inside, 1 lower right outside. 3rd party certified, meets ANSI/ISEA 107-2015, Class 2 Type R standards.

**Safety Vests\***



Solid

| Size    | Solid         | Mesh          |
|---------|---------------|---------------|
|         | Part Number   | Part Number   |
| Medium  | 365311-001-01 | 365310-001-01 |
| Large   | 365311-002-01 | 365310-002-01 |
| X-Large | 365311-003-01 | 365310-003-01 |
| 2XL     | 365311-004-01 | 365310-004-01 |
| 3XL     | 365311-005-01 | 365310-005-01 |
| 4XL     | 365311-006-01 | 365310-006-01 |



Mesh

Sold individually. Velcro closure, Solid – 2 hip and 1 chest pocket, Mesh – no pockets. Meets Class 2 classification. Meets ANSI 107-2015 standard. Allows greater visibility with orange stripe and reflective tape.

\*Available only to customers in USA

**Zippered Safety Vests\*\***



| Size    | Hi-Vis Orange | Hi-Vis Green  |
|---------|---------------|---------------|
|         | Part Number   | Part Number   |
| Medium  | 365317-001-01 | 365319-001-01 |
| Large   | 365317-002-01 | 365319-002-01 |
| X-Large | 365317-003-01 | 365319-003-01 |
| 2XL     | 365317-004-01 | 365319-004-01 |
| 3XL     | 365317-005-01 | 365319-005-01 |
| 4XL     | 365317-006-01 | 365319-006-01 |
| 5XL     | 365317-007-01 | 365319-007-01 |

Economy Class 2 Safety Vest with Two-Tone Trim - Zipper. 100% Polyester Mesh. Zipper Closure. Crown Embroidered Logo. Pockets: 1 Upper Left Front, 1 Lower Right Inside, Zipper closure. 2" silver reflective material. 25 wash max. Meets ANSI/ISEA 107-2015 standards, Class 2 Type R standards.

\*\*Available for all customers

**Zippered Safety Vests\***



| Size    | Hi-Vis Orange | Hi-Vis Green  |
|---------|---------------|---------------|
|         | Part Number   | Part Number   |
| Medium  | 365316-001-01 | 365318-001-01 |
| Large   | 365316-002-01 | 365318-002-01 |
| X-Large | 365316-003-01 | 365318-003-01 |
| 2XL     | 365316-004-01 | 365318-004-01 |
| 3XL     | 365316-005-01 | 365318-005-01 |
| 4XL     | 365316-006-01 | 365318-006-01 |
| 5XL     | 365316-007-01 | 365318-007-01 |

100% polyester mesh. Class 2 safety vests with two-tone trim. Zipper closure. Pockets: 1 upper left front, 1 lower right inside. 2" silver reflective material. 25 wash max. Meets ANSI/ISEA 107-2015, Class 2 Type R standards.

**White Protection Coveralls - Zipper Front\***



| Part Number   | Size    | Sales Unit  |
|---------------|---------|-------------|
| 365302-001-12 | Medium  | 12 per case |
| 365302-002-12 | Large   | 12 per case |
| 365302-003-12 | X-Large | 12 per case |
| 365302-004-12 | 2XL     | 12 per case |
| 365302-005-12 | 3XL     | 12 per case |

Liquid & particulate protection, similar to TYVEK A40. Breathable, elastic wrists and ankles, elastic back for improved fit. Microporous disposable coverall zipper front. Durable and abrasion resistant. Excellent for painting, pressure washing, general maintenance.

**Bouffant Caps\***



| Part Number | Description  |
|-------------|--|
| 365304      | 21" white bouffant cap required to wear in food and medical facilities. Polypropylene. 500/case. |

**One Source Lanyard**



| Part Number | Description   |
|-------------|---|
| 352001      | 17" smooth nylon lanyard comes with 3 attachments: O-ring, metal swivel hook, and accessory loop. |

## Safety Apparel



### Paint Suit\*

| Part Number   | Size    |
|---------------|---------|
| 365303-001-01 | Medium  |
| 365303-002-01 | Large   |
| 365303-003-01 | X-Large |
| 365303-004-01 | 2XL     |
| 365303-005-01 | 3XL     |

Gray. 65/35 poly/cotton. Zipper front, hood, adjustable velcro wrist closures. Elastic back and action seat for ease of movement. Machine washable.



### Blue Protection Coveralls - Zipper Front\*

| Part Number   | Size    | Sales Unit  |
|---------------|---------|-------------|
| 365300-002-12 | Large   | 12 per case |
| 365300-003-12 | X-Large | 12 per case |
| 365300-004-12 | 2XL     | 12 per case |
| 365300-005-12 | 3XL     | 12 per case |

SUPPLIES  
MAY BE  
LIMITED

Provides protection against dry particulates and light liquid splash. Breathable, elastic wrists and ankles, zipper flap. Seamless front. Durable and abrasion resistant. Meets ANSI/ISES 101-1996 sizing standard.



### Vinyl Apron\*

| Part Number | Sales Unit  |
|-------------|-------------|
| 365278-012  | 12 per case |

Economical, 6 mil, blue. Resistant to solvents, chemicals, oil and grease. Provides tear, abrasion and puncture resistance.

⚠ **WARNING:** Cancer and reproductive harm - [www.P65Warnings.ca.gov](http://www.P65Warnings.ca.gov)



### Apron\*

| Part Number | Size      |
|-------------|-----------|
| 365260-001  | 35" x 45" |

Expanded PVC coated material with fabric backing. Use with batteries. Waterproof and abrasion resistant.



### Welding Jacket\*\*

| Part Number   | Size    |
|---------------|---------|
| 323017-000-01 | Small   |
| 323017-001-01 | Medium  |
| 323017-002-01 | Large   |
| 323017-003-01 | X-Large |
| 323017-004-01 | 2XL     |
| 323017-005-01 | 3XL     |
| 323017-006-01 | 4XL     |
| 323017-007-01 | 5XL     |
| 323017-008-01 | 6XL     |

Cool, comfortable, and washable, this jacket offers protection from sparks in light welding applications. 30" length. Weldlife™ flame retardant 100% cotton fabric — anti-static, rot and mildew resistant. Relaxed fit design offers comfort for all-day wearability. Adjustable snap wrist, and large inside pocket. Leather reinforced black anodized non-reflective snaps.

\*\*Available for all customers



### Welding Gloves\*

| Part Number | Sales Unit | Size     |
|-------------|------------|----------|
| 365473      | 1 pair     | One Size |

Economy welding glove. 13" length. Fully cotton lined and welted cowhide.



### Knit Cap with LED Light\*

| Part Number | Color  |
|-------------|--------|
| 365305-001  | Black  |
| 365305-002  | Yellow |
| 365305-003  | Orange |

**NEW!**

100% acrylic knit. Rechargeable LED light can be charged with USB port. Light functions include High, Medium and Flash 150 lumens. Meets CE and RoHS standards.

\*Available only to customers in USA

## Hard Hats

### Hard Hat\*

| Part Number | Color          |
|-------------|----------------|
| 365470-001  | Blue           |
| 365470-002  | High Vis Green |
| 365470-003  | Red            |
| 365470-004  | White          |
| 365470-005  | Yellow         |
| 365470-006  | Orange         |



- High density polyethylene construction
- 4 point ratchet suspension
- Meets ANSI Z89.1-2014 standard, type 1, class C, G & E



**Note:** Universal hard hat adapter (P.N. 365262) is listed on page 2.10 and attachable ear muffs (P.N. 365283) on page 2.08.

\*Available only to customers in USA



**CROWN  
BRANDED**

### Hard Hat\*\*

| Part Number | Color | Brand |
|-------------|-------|-------|
| 365475      | Grey  | Crown |

- Four position harness points allows moving the harness forward, backward, up or down.
- Made with ABS material, strong yet ultralight weight.
- Easy to grasp triangular knob adjusts from 6.5 to 8 inch hat size.
- Low profile design offers a low center of gravity for better balance.
- Meets ANSI Z89.1-2009 Standards, Type 1, Class C, G, and E & CSA Z94.1-05.

\*\*Available for all customers

## Wall Signs

NEW!



323030



323031



323032

### Wall Signs

| Part Number | Description                    |
|-------------|--------------------------------|
| 323030      | Social Distance 6 ft.          |
| 323031      | Wear Face Mask                 |
| 323032      | Safety First - Social Distance |

- Size 10"x14"
- Rounded corners
- 3/16" mounting holes
- Impact resistant with slight flexibility
- .055" thick polyethylene

## Safety Related Accessories

Continued ▶



### Lockout Tag Out Kit (single connector only)

#### Part Number

300037 (includes 10 lockout tags)

(Dual language tags English \ Spanish)

Fits - SB and SBX connectors

Fits - 50, 175 and 350 AMP connectors

Individual Items

300037-002 (box only)

300037-003 (lock only)

Accessories:

Tag Refill Kit (Qty. 25 pc)

P.N. 300037-025



### Breaker Lockout Pouch Kit

#### Part Number

365007

Lightweight, portable pouch contains lockout devices to secure electrical equipment.

Pouch contains: 1- small plug lockout, 3- wall switch lockouts, 3- universal multi-pole lockouts, 3- 277 volt "no hole" lockouts, 2- 480/600 volt "no hole" lockouts, 1- cleat 277 general use, 1- cleat 480/600 general use. Metal loops are on the pouch for hanging on a belt.



### Lockout Cinch Sack

#### Part Number

365006

Electrical lockout device designed for oversized and hard-to-reach connections. Accommodate up to 6 padlocks. Fits hanging controls, oversized levers and plugs. Size: 7" x 17". Color: Red.



### Lock Out Box (dual connectors)

#### Part Number

300420

Fits - SB, SBX, and DIN connectors

Fits - 50, 175 and 350 AMP connectors

Note: Lock Not Included

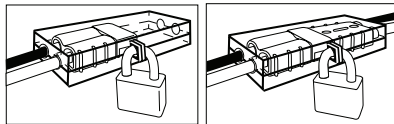

Lock Out

Lock Together



### Barricade/Caution Tape\*

#### Part Number Sales Unit

365265

Single

Weather resistant. Compliant under OSHA standards, 1910-144(A) physical standards. 3" x 1000', 3.0 mil.

⚠️ WARNING: Cancer and reproductive harm - [www.P65Warnings.ca.gov](http://www.P65Warnings.ca.gov)



### Circuit Breaker Lockout Single

#### Part Number

365008

Circuit breaker lockout - single pole, does not require a switch breaker w/recessed hole. Constructed of rigid plastic. 2.30" L x 1.0" W x 0.75" H.

\*Available only to customers in USA

## Safety Related Accessories



### Collapsible Safety Cone\*

| Part Number | Height |
|-------------|--------|
| 365268      | 28"    |

Orange with 6" and 4" reflective collars, collapses to less than 3" for stowing and transporting, vinyl carrying case. Meets MUTCD specifications. Optional flashing hazard light - P.N. 365269.



### Flashing Cone Light\*

| Part Number |
|-------------|
| 365269      |

2" safety light that will fit collapsible cone - P.N. 365268. Provides 130 flashes per minute. Uses 2 AA batteries.



### Safety/Traffic Cones\*

| Part Number | Height |
|-------------|--------|
| 365266-001  | 18"    |
| 365266-002  | 28"    |

Tough all-weather orange cones. 100% PVC. Meets federal MUTCD & NCHRP-350 specifications.

### Safety/Traffic Cone\*

| Part Number | Color  | Height |
|-------------|--------|--------|
| 365266-003  | Orange | 28"    |

Tough all-weather cone. 100% PVC. Meets federal MUTCD & NCHRP-350 specifications. 4" & 6" reflective collars.



### Programmable Security Lock

This keypad offers an enhanced level of security to deter unauthorized or untrained personnel from operating the vehicle. A four digit Personal Identification Number can be assigned for up to 200 operators that use the vehicle. Supervisor can "lockout" vehicle through keypad and can program keypad to turn vehicle "OFF" automatically if vehicle is idle for prolonged periods.

Power input is 15 amps externally fused, 48 volts maximum. Power output is 10 amps maximum. Operating temperature range is -40 to +85° Celsius.

| Part Number | Used on                        | Kit Instructions |
|-------------|--------------------------------|------------------|
| 130863-001  | Wave                           |                  |
| 130863-002  | RC3, FC4, Turret, SP48, SP3000 |                  |
| 130863-003  | WP2300                         | PF26004          |
| 130863-003  | WP3000                         | PF26265          |

### Kit Instructions for Programming

|         |                  |
|---------|------------------|
| PF11830 | Dealer Level     |
| PF11831 | Manager Level    |
| PF11832 | Supervisor Level |



### Fire Extinguisher

**Part Number**  
079528 (includes bracket)

2.5 lb. multi-purpose ABC dry chemical with aluminum valve

Accessory:  
Mounting Bracket (P.N. 379528)

**Note:** See Work Assist section for other kits.



### Fire Extinguisher

**Part Number**  
127237 (includes bracket/two straps)

2.5 lb. multi-purpose ABC dry chemical with aluminum valve

Accessory:  
Mounting Bracket (2 strap) (P.N. 379528-002)

**Note:** See Work Assist section for other kits.



\*Available only to customers in USA



# Spill Absorbent Products

Be prepared for a variety of accidental spills

## Acid Spill Absorber and Neutralizer



| Part Number | Sales Unit | Absorbs                   |
|-------------|------------|---------------------------|
| 300421      | 25 lbs.    | 6 gallons of electrolyte  |
| 300421-030  | 160 lbs.   | 40 gallons of electrolyte |

- Specifically formulated to absorb and neutralize battery acid, with color change to show when acid is neutralized and safe for disposal
- Ideal for use in acid drip pans
- Safe and non-hazardous
- Sweeps up clean and dry, is not dusty like kitty litter/clay
- Durable easy to store container with resealable lid
- Instructions and MSDS included See OSHA 1926.441 & 1910.173

**Cold Form:** Uses pre-formed cotton fibers. These cotton fibers, once processed, provide a high degree of strength, durability & absorbency. Requires less energy to produce, earth-friendly/green, made from renewable & recycled resources. Poly backed pads prevent leaks from penetrating to surface below.



## Pads & Rolls\*

| Part Number | Sales Unit  |
|-------------|---|
| 365321-100  | Gray, 15" x 18", 100/case                           |
| 365322-001  | Gray, 28" x 150", 1 roll/case, perforated every 18" |

Earth friendly/green. Large liquid holding capacity. Quick absorbency. Long product life. Great for fast cleanup. Absorbs oil, coolants, solvents and water.

GREEN

## QuiKleen Absorbent Powder



| Part Number | Sales Unit              |
|-------------|-------------------------|
| 363201      | Case (4) Easy Pour Jugs |
| 363205      | 5 Gallon Pail           |

QuiKleen Absorbent Powder is an instant response to your most frequent liquid spill needs. It is an environmentally safe product that is landfill acceptable and EPA certified. Absorbs gas, oil, coolants, water, eggs, syrups, paint, blood, vomit, and many solvents. (DO NOT USE IN CLEANUP OF HYDROFLUORIC ACID.)

**Meltblown Technology:** Polypropylene — the industry standard. American made polypropylene is the most popular sorbent in the market.



## Pads & Rolls\*

| Part Number | Sales Unit   |
|-------------|--|
| 365323-100  | Gray, 15" x 18", 100/case                                    |
| 365324-001  | Gray, dimpled, 30" x 150", 1 roll/case, perforated every 18" |

Quick absorbency. Large liquid holding capacity. Long product life. Great for fast cleanup. Absorbs oil, coolants, solvents and water.

## Matting\*

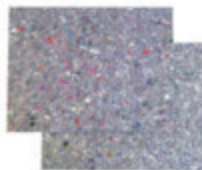

| Part Number | Sales Unit                    |
|-------------|-------------------------------|
| 365319-001  | 18" x 150' roll; 2 rolls/case |
| 365320-001  | 36" x 150' roll; 1 roll/case  |

Use as a maintenance rug. Keep liquid from damaging floors. Absorbs non-aggressive liquids. Non-perforated.



## Pads\*

| Part Number | Sales Unit                |
|-------------|---------------------------|
| 365328-100  | Gray, 15" x 18", 100/case |

Fastest absorbing. Superior liquid holding capacity. Longest product life. Absorbs oil, coolants, solvents and water.

## Adhesive Mat\*



| Part Number | Sales Unit                    |
|-------------|-------------------------------|
| 365329-050  | Gray, 34" x 50', 1 roll/case  |
| 365329-100  | Gray, 34" x 100', 1 roll/case |

SureGrip™ adhesive absorbent mat. Highly absorbent, soaks moisture and wicks it away to prevent puddling, fast drying, easy to clean. Adhesive-backed, stays put - no shifting, bunching, or flipping over. Durable Needle

Punch manufacturing - withstands forklift traffic. Cut to length, peels up easily for replacement. Fire retardant as per ASTM 726.



## Drum Top Covers\*

| Part Number | Sales Unit    |
|-------------|---------------|
| 365325-025  | Gray, 25/case |

Absorb excess liquids on top of 55 gallon drum.



## Socks\*

| Part Number | Sales Unit              |
|-------------|-------------------------|
| 365326-040  | Gray, 42" x 3", 40/case |

Flexible to fit around machinery and excellent for containing spills. Absorbs oil, coolants, solvents and water.



## Response Kits\*

| Part Number | Sales Unit |
|-------------|------------|
| 365327-001  | 1 kit      |

Packed in a zippered, clear vinyl bag. Labeled with an easy to read yellow safety tag. Oil specific. Includes 20 pads, 2 socks, 2 cleanup bags.

\*Available only to customers in USA

## Battery Spill Kit

### Part Number - 300035\*

Note: Instructional label inside lid.

#### ▲ Individual Items

| Part Number | Description  | Quantity  |
|-------------|--|-----------|
| 300042      | Face shield  | 1         |
| 300041      | Head gear  | 1         |
| 300049      | 32 oz acid neutralizer (per bottle)                | 2 bottles |
| 300043      | Acid spill absorbent cleanup pads                  | 10        |
| 300047      | Yellow heavy-duty chemical disposal bag; 33" x 39" | 1         |
| 300048      | Mini broom   | 1         |
| 300051      | 16 oz eye wash flush*                              | 1 bottle  |
| 300044      | Green acid resistant glove, nitrile                | 1 pair    |
| 300045      | Acid-resistant sleeve                              | 1 pair    |
| 300050      | Acid-resistant rubber overboot                     | 1 pair    |
| 300046      | Acid-resistant apron                               | 1         |
| 300035-001  | Bucket   | 1         |

\*Three-year shelf life.

Note: Individual part numbers sold by piece or pair.



## First Aid Kits

### Class A Polywhite First Aid Kit\*

#### Part Number

365291

- Designed for common workplace injuries such as major and minor wounds, minor burns and eye injuries
- Kit meets Z308.1-2015 minimum fill requirements for Class A Type I, II, III or IV
- Color coded and unitized for ease of refills
- Made from heavy duty plastic to withstand tough work environments
- Portable or mountable
- Kit will continue to remain compliant only when it is maintained with products that meet the standard at specific quantities



### ProWorks® First Aid Kit\*

#### Part Number

365290-010

- For groups of 10
- Should be in clear view of workers in case of accidents
- Kit includes: Bandages, gauze, adhesive tape, antiseptic, cold pack, scissors, soothing sting swabs, burn cream packets, and cut cleaner



### First Aid Kit\*\*

#### Part Number

365293

- Contains: (1) Emergency First Aid Pocket Guide, (1) ½"x5yd. Tape, (1) Eye Wash 4oz., (1) Elastic Gauze 2"x4.5yd., (1) Disposable Forcep, (1) Wound Seal, (2 pr.) Nitrile Gloves, (1) 3-1 Antibiotic Ointment, (1) Waterjel Burn Pack, (1) Ice Pack Small, (1) 40" Triangular Bandage, (1) 4" Compress Bandage, (10) Fingertip Bandages, (10) Knuckle Bandages, (16) Plastic 1"x3" Bandages, (1) 2oz. Antiseptic Spray, (10) Clean Wipes, (4) 3"x3" Gauze Pads, (1) Metal Kit Box.
- Meets ANSI standard for workplace vehicle kits under ANSI Z308.1-2015.
- Dimensions: 9.5" Wide x 7" Tall x 2.5" Deep.



\*\*Available for all customers

### Class B Metal First Aid Kit\*

#### Part Number

365292

- Designed for high risk work zones such as construction, utilities, industrial and manufacturing
- Kit meets Z308.1-2015 minimum fill requirements for Class B Type I, II, III or IV
- Suggested for any work zone where personal protective equipment is required
- Color coded and unitized for ease of refills
- Made from heavy duty metal to withstand tough work environments
- Portable or mountable
- Kit will continue to remain compliant only when it is maintained with products that meet the standard at specific quantities



\*Available only to customers in USA

## Section 3

# Warehouse

### Contents

|   |      |
|---|------|
| Bollards and Bumpers  | 3.02 |
| Rack Protection   | 3.03 |
| Floor Tape  | 3.04 |
| Floor Signs   | 3.08 |
| Ladders and Platforms   | 3.09 |
| Pallets and Accessories   | 3.10 |
| Wheel Chocks  | 3.11 |
| Jacks   | 3.12 |
| Hand Trucks   | 3.14 |
|  Hoppers | 3.15 |
| Dockboards  | 3.17 |
| Tubes   | 3.17 |
| Floor Mats  | 3.18 |
| Biljax OEM Parts  | 3.19 |
| Genie OEM Parts   | 3.21 |
| Skyjack OEM Parts   | 3.23 |

#### New Items:

Employees Only Floor Sign - p. 3.09  
Practice Social Distancing Floor Sign - p. 3.09  
No Entry Beyond This Point Floor Sign - p. 3.09  
Maintain Distance Floor Sign - p. 3.09  
Wait Here Floor Sign - p. 3.09  
Keep Safe Distance Floor Sign - p. 3.09  
Self-Dumping Hopper - p. 3.15  
Portable Steel Hopper - p. 3.15  
Low Profile Parts Hopper - p. 3.16  
Casters for Self-Dumping Hopper - p. 3.16  
Heavy Duty Poly Lids for Hopper - p. 3.16  
Floor Mats - p. 3.18

Note: 1910.178(q)(5) (1998) of the Occupational Safety and Health Act (OSHA) requires that "All parts of any such industrial truck requiring replacement shall be replaced only by parts equivalent as to safety with those used in the original design."

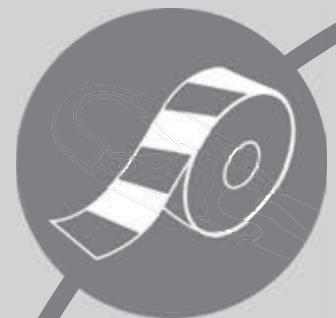

# Bollards and Bumpers

## Steel Pipe Safety Bollard\*

| Part Number | Dimensions |
|-------------|------------|
| 360039-078  | 24" x 4½"  |
| 360039-079  | 24" x 5½"  |
| 360039-080  | 36" x 4½"  |
| 360039-081  | 36" x 5½"  |
| 360039-082  | 42" x 4½"  |
| 360039-083  | 42" x 5½"  |



360039-081

## Bollard - 4¼" Diameter\*

Durable construction. Includes a top mounted eyelet for safety chains or ropes. Unit is lockable, two keys included.

| Part Number | Description          |
|-------------|----------------------|
| 360039-1341 | Fixed Height         |
| 360039-1342 | Fold-Down, Yellow    |
| 360039-1343 | Fold-Down, Stainless |



360039-1341

360039-1342

360039-1343

## Bollard - 2½" Diameter\*

Bollards feature durable construction for lasting through the harshest environments. Includes a top mounted eyelet for safety chains or ropes for maximum efficiency. Includes 2 wrap-around reflectors.

| Part Number | Description  |
|-------------|--------------|
| 360039-1346 | Fixed Height |
| 360039-1347 | Fold-Down    |



360039-1346

360039-1347

## Specialty Molded Dock Bumpers\*

Manufactured from fiber reinforced prime rubber containing nylon and polyester. Features: Simple installation for immediate use. Use on loading dock to protect trailer & dock. Pre-drilled countersunk mounting holes make installation easy. Installation hardware not included.

| Part Number | Steps        | Wheels         |
|-------------|--------------|----------------|
| 360039-101  | L-Shaped     | 18" x 18" x 4" |
| 360039-099  | Plastic Face | 12" x 13" x 4" |
| 360039-095  | Rectangular  | 12" x 12" x 3" |
| 360039-102  | Rectangular  | 16" x 5" x 2"  |
| 360039-103  | Rectangular  | 18" x 8" x 2"  |
| 360039-096  | Rectangular  | 24" x 12" x 6" |
| 360039-098  | Square       | 12" x 13" x 4" |
| 360039-104  | Steel Faced  | 5" x 16" x 2"  |
| 360039-105  | Steel Faced  | 8" x 18" x 2"  |
| 360039-097  | T-Shaped     | 22" x 22" x 3" |



360039-095



360039-101



360039-099



360039-101



360039-104

## Laminated Dock Bumpers\*

Designed for use on loading docks to protect trailers and dock area. Bolt or weld bumper to the dock. Made from recycled truck tires. Width is bolt hole center to bolt hole center. Installation hardware not included.

| Part Number | Description                                 |
|-------------|---|
| 360039-138  | 6" x 24" x 4.5" Projection                  |
| 360039-139  | 6" x 36" x 4.5" Projection                  |
| 360039-109  | 10" x 12" x 4.5" Projection                 |
| 360039-112  | 10" x 12" x 4.5" Projection - Flat one side |
| 360039-110  | 10" x 12" x 6" Projection                   |
| 360039-111  | 10" x 14" x 4.5" Projection                 |
| 360039-113  | 10" x 14" x 6" Projection                   |
| 360039-114  | 10" x 18" x 4.5" Projection                 |
| 360039-115  | 10" x 18" x 6" Projection                   |
| 360039-116  | 10" x 24" x 4.5" Projection                 |
| 360039-117  | 10" x 24" x 6" Projection                   |
| 360039-118  | 10" x 30" x 4.5" Projection                 |
| 360039-119  | 10" x 30" x 6" Projection                   |
| 360039-120  | 10" x 36" x 4.5" Projection                 |
| 360039-121  | 10" x 36" x 6" Projection                   |
| 360039-122  | 10" x 96" x 4.5" Projection                 |
| 360039-123  | 12" x 12" x 4.5" Projection                 |
| 360039-124  | 12" x 12" x 6" Projection                   |
| 360039-125  | 12" x 14" x 4.5" Projection                 |
| 360039-126  | 12" x 14" x 4.5" Projection - Flat one side |
| 360039-127  | 12" x 14" x 6" Projection                   |
| 360039-128  | 12" x 18" x 4.5" Projection                 |
| 360039-129  | 12" x 18" x 6" Projection                   |
| 360039-130  | 12" x 24" x 4.5" Projection                 |
| 360039-131  | 12" x 24" x 6" Projection                   |
| 360039-132  | 12" x 30" x 4.5" Projection                 |
| 360039-133  | 12" x 30" x 6" Projection                   |
| 360039-134  | 12" x 36" x 4.5" Projection                 |
| 360039-135  | 12" x 36" x 6" Projection                   |
| 360039-136  | 12" x 96" x 4.5" Projection                 |
| 360039-137  | 12" x 96" x 6" Projection                   |



360039-109



360039-126



360039-138

\*Available only to customers in USA

## Rack Protection

### Overhead Door Track Protector\*

Angle design protects track for overhead doors from damage. Universal design may be used on either left or right side of door. Easy-to-install design only requires three bolts. Heavy-duty steel construction provides durable long-lasting use.

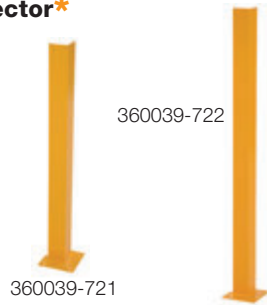

| Part Number | Description |
|-------------|-------------|
| 360039-721  | 36.25"      |
| 360039-722  | 48.25"      |

360039-721

### Structural Rack Guard\*

Heavy-duty cast steel construction. Powder-coat yellow. Four pre-drilled mounting holes in base plate allow quick lag down installation. Installation hardware sold separately.



| Part Number | Description |
|-------------|-------------|
| 360039-936  | 24" x 8"    |
| 360039-937  | 36" x 8"    |
| 360039-938  | 24" x 10"   |
| 360039-939  | 36" x 10"   |

360039-938

360039-939

### Rack Protector

Part Number - 351097-202

Molded of energy-absorbing rubber with a "U-shaped" steel insert and force-distributing rubber voids. Protects rack structure from frontal, angled and side impacts. Snaps onto rack for protection. Requires no hardware or straps to retain the guard column. 12" x 5.5" - snaps onto rack for protection.



\*Available only to customers in USA

## Competitive Pre-Packaged Wheel Kits for Manual & Electric Pallet Jack Trucks

- All parts needed in one kit
- Bearings assembled in wheels/rollers
- Kits available for competitive trucks, including Hyster, Raymond, Toyota, Yale, Big Joe, and many more
- Load wheel kits and complete wheel kits (load & steer wheels)



See Wheels and Tires Section



## The 5s Pillars



### 5s Floor Color Recommendations

Use safety tapes, floor markers, and safety floor signs to identify, communicate, and reinforce proper safety practices.

Your facility will shine with the proper placement inventory tools, and machinery identified with brightly colored floor tapes, markers and signs.

Set things in order by using different color floor tapes and floor markings to show work flow patterns, establish borders between work areas and mark the proper placement of tools, inventories, and machinery. Sort your critical work areas and crucial inventory areas with floor tape and floor markers to obtain optimal production.

Sustain your 5s implementation by standardizing your 5s procedures and using the same floor tape products for certain areas throughout the facility.

**Safety YELLOW - Caution: Pedestrian Aisle Ways**

**Safety RED - Safety Areas – Emergency Exit Ways and Do Not Block Fire Extinguishers**

**Safety WHITE - Production Equipment – Machines, Carts, Incoming Racks**

**Safety GREEN - Safety Related Equipment/Raw Material Areas – Eye Wash Stations & Spillage Showers**

**Safety ORANGE - Parts for Machinery Area**

**Safety BLUE - Work in Process Area or Equipment Under Repair Zone**

**Safety BLACK - Finished Goods Area**

**Safety YELLOW/BLACK - Extra Caution Areas - Pedestrian Walkways or Aisle Ways**

**Safety RED/WHITE - Safety Equipment Areas – Fire Extinguishers, Electrical Panels, AED Machines, etc.**

**Floor Tape Features:** • Installs quickly • Removable adhesive backing • Beveled edges • Removes easily • 3-year warranty

### Solid Floor Tape - 100' Roll



| Color  | 2" Wide    | 3" Wide    | 4" Wide    | 6" Wide    |
|--------|------------|------------|------------|------------|
| Black  | 351097-001 | 351097-056 | 351097-115 | 351097-144 |
| Blue   | 351097-002 | 351097-057 | 351097-116 | 351097-145 |
| Brown  | 351097-003 | 351097-058 | 351097-117 | 351097-146 |
| Gray   | 351097-004 | 351097-059 | 351097-118 | 351097-147 |
| Green  | 351097-005 | 351097-060 | 351097-119 | 351097-148 |
| Orange | 351097-006 | 351097-061 | 351097-120 | 351097-149 |
| Purple | 351097-008 | 351097-062 | 351097-122 | 351097-150 |
| Red    | 351097-010 | 351097-063 | 351097-124 | 351097-151 |
| White  | 351097-012 | 351097-064 | 351097-126 | 351097-152 |
| Yellow | 351097-042 | 351097-093 | 351097-130 | 351097-155 |

### Floor Tape with Center Line - 100' Roll



| Color  | Line Color | 2" Wide    | 4" Wide    |
|--------|------------|------------|------------|
| Orange | Blue       | 351097-007 | 351097-121 |
| Red    | White      | 351097-011 | 351097-125 |
| Yellow | Black      | 351097-043 | 351097-131 |
| Yellow | Blue       | 351097-045 | 351097-133 |

### 4" Yellow Reflective Center Line Floor Tape - 75' Roll

Part Number - 351097-195



### Floor Tape with Chevrons - 100' Roll



| Color  | Chevrons | 2" Wide    | 3" Wide    | 4" Wide    | 6" Wide    |
|--------|----------|------------|------------|------------|------------|
| White  | Black    | 351097-013 | 351097-065 | 351097-127 | 351097-153 |
| White  | Red      | 351097-014 | 351097-066 | 351097-128 | 351097-154 |
| Yellow | Black    | 351097-044 | 351097-094 | 351097-132 | 351097-156 |

### Floor Tape with Chevrons - 100' Roll



| Color       | 2" Wide    | 4" Wide    |
|-------------|------------|------------|
| White/Blue  | 351097-200 | 351097-199 |
| White/Green | 351097-201 | 351097-198 |

### Luminescent Center Line Floor Tape - 100' Roll

Luminescent center line highlights exit paths during power outages.



| Color  | 2" Wide    | 4" Wide    |
|--------|------------|------------|
| Red    | 351097-009 | 351097-123 |
| Yellow | 351097-041 | 351097-129 |

# Floor Tape

Continued ▶

## Brick Floor Tape - 100' Roll

| Color  | 2" Wide    |
|--------|------------|
| Yellow | 351097-196 |
| Blue   | 351097-197 |

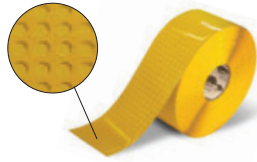

## Freezer Floor Tape - 100' Roll

| Color  | 2" Wide    | 4" Wide    |
|--------|------------|------------|
| Yellow | 351097-246 | 351097-194 |
| Clear  | 351097-226 | 351097-227 |



## Anti-Slip Floor Tape - 60' Roll



| Color  | 2" Wide    | 3" Wide    | 4" Wide    | 6" Wide    |
|--------|------------|------------|------------|------------|
| Yellow | 351097-211 | 351097-212 | 351097-213 | 351097-214 |
| Black  | 351097-215 | 351097-216 | 351097-217 | 351097-218 |
| Glow   | 351097-219 | 351097-220 | 351097-221 | 351097-222 |

## Anti-Slip Chevron Floor Tape - 60' Roll

Color: Black & Yellow



| 2" Wide    | 3" Wide    | 4" Wide    | 6" Wide    |
|------------|------------|------------|------------|
| 351097-248 | 351097-247 | 351097-249 | 351097-250 |

## Floor Tape Applicator



| Part Number | Tape Width |
|-------------|------------|
| 351097-364  | 2", 3", 4" |

⚠ WARNING: Cancer - [www.P65Warnings.ca.gov](http://www.P65Warnings.ca.gov)

## Segment



| Color                | 10"L x 2"W    | 10"L x 3"W    | 10"L x 4"W    | 10"L x 6"W    |
|----------------------|---------------|---------------|---------------|---------------|
| Yellow               | 351097-293-01 | 351097-305-01 | 351097-318-01 | 351097-331-01 |
| Red                  | 351097-294-01 | 351097-306-01 | 351097-319-01 | 351097-332-01 |
| White                | 351097-295-01 | 351097-307-01 | 351097-320-01 | 351097-333-01 |
| Green                | 351097-296-01 | 351097-308-01 | 351097-321-01 | 351097-334-01 |
| Blue                 | 351097-297-01 | 351097-309-01 | 351097-322-01 | 351097-335-01 |
| Orange               | 351097-252-01 | 351097-310-01 | 351097-323-01 | 351097-336-01 |
| Gray                 | 351097-298-01 | 351097-311-01 | 351097-324-01 | 351097-337-01 |
| Purple               | 351097-299-01 | 351097-312-01 | 351097-325-01 | 351097-338-01 |
| Black                | 351097-300-01 | 351097-313-01 | 351097-326-01 | 351097-339-01 |
| Brown                | 351097-301-01 | 351097-314-01 | 351097-327-01 | 351097-340-01 |
| Yellow/Black Chevron | 351097-302-01 | 351097-315-01 | 351097-328-01 | 351097-341-01 |
| White/Black Chevron  | 351097-303-01 | 351097-316-01 | 351097-329-01 | 351097-342-01 |
| White/Red Chevron    | 351097-304-01 | 351097-317-01 | 351097-330-01 | 351097-343-01 |

## Wide, Solid Angle



| Color  | 6"L x 2"W     | 6"L x 3"W     | 10"L x 4"W    |
|--------|---------------|---------------|---------------|
| Black  | 351097-015-01 | 351097-067-01 | 351097-268-01 |
| Blue   | 351097-017-01 | 351097-069-01 | 351097-266-01 |
| Brown  | 351097-019-01 | 351097-071-01 | 351097-271-01 |
| Gray   | 351097-021-01 | 351097-073-01 | 351097-269-01 |
| Green  | 351097-023-01 | 351097-075-01 | 351097-267-01 |
| Orange | 351097-025-01 | 351097-077-01 | 351097-265-01 |
| Purple | 351097-027-01 | 351097-079-01 | 351097-270-01 |
| Red    | 351097-029-01 | 351097-081-01 | 351097-264-01 |
| White  | 351097-031-01 | 351097-083-01 | 351097-272-01 |
| Yellow | 351097-037-01 | 351097-089-01 | 351097-263-01 |

## Wide, Solid T-Shaped & Angles w/Chevrons



| Color  | Shape | Chevrons | 2" Wide (Single) | 3" Wide (Single) |
|--------|-------|----------|------------------|------------------|
| White  | T     | Black    | 351097-035-01    | 351097-087-01    |
| White  | T     | Red      | 351097-036-01    | 351097-088-01    |
| Yellow | T     | Black    | 351097-040-01    | 351097-092-01    |
| White  | Angle | Black    | 351097-032-01    | 351097-084-01    |
| White  | Angle | Red      | 351097-033-01    | 351097-085-01    |
| Yellow | Angle | Black    | 351097-038-01    | 351097-090-01    |



## Wide, Solid T-Shaped

| Color  | 2" Wide (Single) | 3" Wide (Single) |
|--------|------------------|------------------|
| Black  | 351097-016-01    | 351097-068-01    |
| Blue   | 351097-018-01    | 351097-070-01    |
| Brown  | 351097-020-01    | 351097-072-01    |
| Gray   | 351097-022-01    | 351097-074-01    |
| Green  | 351097-024-01    | 351097-076-01    |
| Orange | 351097-026-01    | 351097-078-01    |
| Purple | 351097-028-01    | 351097-080-01    |
| Red    | 351097-030-01    | 351097-082-01    |
| White  | 351097-034-01    | 351097-086-01    |
| Yellow | 351097-039-01    | 351097-091-01    |

## 2"L x .75"W Mini Angles



| Color  | Part Number   |
|--------|---------------|
| Yellow | 351097-236-01 |
| Red    | 351097-237-01 |
| Orange | 351097-238-01 |
| Blue   | 351097-239-01 |
| Green  | 351097-240-01 |
| Black  | 351097-241-01 |
| Gray   | 351097-242-01 |
| Purple | 351097-243-01 |
| Brown  | 351097-244-01 |
| White  | 351097-245-01 |

## 10"L x 6"W Arrow



| Color  | Part Number (Single) |
|--------|----------------------|
| Black  | 351097-367-01        |
| Blue   | 351097-169-01        |
| Brown  | 351097-170-01        |
| Gray   | 351097-181-01        |
| Green  | 351097-182-01        |
| Orange | 351097-183-01        |
| Purple | 351097-184-01        |
| Red    | 351097-185-01        |
| White  | 351097-186-01        |
| Yellow | 351097-189-01        |

## Wide, Half Angle or X



| Color  | 2" Wide (Single) |
|--------|------------------|
| Black  | 351097-258-01    |
| Blue   | 351097-256-01    |
| Brown  | 351097-261-01    |
| Gray   | 351097-259-01    |
| Green  | 351097-257-01    |
| Orange | 351097-253-01    |
| Purple | 351097-260-01    |
| Red    | 351097-255-01    |
| White  | 351097-262-01    |
| Yellow | 351097-254-01    |

## Arrow Roll



| Color  | 4" Wide (280 Arrows) | 5.5" Wide (200 Arrows) |
|--------|----------------------|------------------------|
| Yellow | 351097-354           | 351097-344             |
| Red    | 351097-355           | 351097-345             |
| Orange | 351097-356           | 351097-346             |
| Blue   | 351097-357           | 351097-347             |
| Green  | 351097-358           | 351097-348             |
| Black  | 351097-359           | 351097-349             |
| Gray   | 351097-360           | 351097-350             |
| Purple | 351097-361           | 351097-351             |
| White  | 351097-362           | 351097-352             |
| Brown  | 351097-363           | 351097-353             |





## 10"L x 6"W Arrow with Chevrons

| Color  | Chevrons | Part Number (Single) |
|--------|----------|----------------------|
| White  | Black    | 351097-187-01        |
| Yellow | Black    | 351097-190-01        |
| White  | Red      | 351097-188-01        |



# Floor Tape

## Solid Dot

|   |        | .75" Diam.<br>(Single) | 1" Diam.<br>(Single) | 2.7" Diam.<br>(Single) | 3.5" Diam.<br>(Single) | 3.75" Diam.<br>(Single) | 5.7" Diam.<br>(Single) |
|---|--------|------------------------|----------------------|------------------------|------------------------|-------------------------|------------------------|
|  | Color  |                        |                      |                        |                        |                         |                        |
|   | Black  | 351097-273-01          | 351097-283-01        | 351097-046-01          | 351097-095-01          | 351097-105-01           | 351097-134-01          |
|   | Blue   | 351097-274-01          | 351097-284-01        | 351097-047-01          | 351097-096-01          | 351097-106-01           | 351097-135-01          |
|   | Brown  | 351097-275-01          | 351097-285-01        | 351097-048-01          | 351097-097-01          | 351097-107-01           | 351097-136-01          |
|  | Gray   | 351097-276-01          | 351097-286-01        | 351097-049-01          | 351097-098-01          | 351097-108-01           | 351097-137-01          |
|   | Green  | 351097-277-01          | 351097-287-01        | 351097-050-01          | 351097-099-01          | 351097-109-01           | 351097-138-01          |
|   | Orange | 351097-278-01          | 351097-288-01        | 351097-051-01          | 351097-100-01          | 351097-110-01           | 351097-139-01          |
|   | Purple | 351097-279-01          | 351097-289-01        | 351097-052-01          | 351097-101-01          | 351097-111-01           | 351097-140-01          |
|  | Red    | 351097-280-01          | 351097-290-01        | 351097-053-01          | 351097-102-01          | 351097-112-01           | 351097-141-01          |
|   | White  | 351097-281-01          | 351097-291-01        | 351097-054-01          | 351097-103-01          | 351097-113-01           | 351097-142-01          |
|   | Yellow | 351097-282-01          | 351097-292-01        | 351097-055-01          | 351097-104-01          | 351097-114-01           | 351097-143-01          |

## Footprint

|   | Color  | Large - 1 pair<br>(12" L x 5" W) | Small - 1 pair<br>(9.5" L x 3.5" W) |
|---|--------|----------------------------------|-------------------------------------|
|  | Black  | 351097-157-01                    | 351097-171-01                       |
|   | Blue   | 351097-158-01                    | 351097-172-01                       |
|   | Brown  | 351097-159-01                    | 351097-173-01                       |
|   | Gray   | 351097-160-01                    | 351097-174-01                       |
|   | Green  | 351097-161-01                    | 351097-175-01                       |
|   | Orange | 351097-166-01                    | 351097-176-01                       |
|   | Purple | 351097-167-01                    | 351097-177-01                       |
|   | Red    | 351097-168-01                    | 351097-178-01                       |
|   | White  | 351097-191-01                    | 351097-179-01                       |
|   | Yellow | 351097-192-01                    | 351097-180-01                       |

## Footprint with Luminescent Center Line



1 Pair - 9.5" L x 3.5" W

Part Number - 351097-193-01

## Paint Applicators

Handheld wand applicator is a lightweight applicator used for marking paint lines on ground. Wheels assist in creating an even line for optimal results. Pull trigger to spray applicator holds one standard aerosol.

| Part Number | Description                     |
|-------------|---------------------------------|
| 360039-1177 | Handheld Wand Applicator        |
| 360039-1178 | Portable Applicator with Wheels |



## Label Protectors



| Part Number   | Description                         |
|---------------|-------------------------------------|
| 351097-165-01 | 10" x 6"                            |
| 351097-366-01 | 10" x 6" (Heavy Duty: 50 mil thick) |
| 351097-373-01 | 13" x 10"                           |

## All Purpose Floor Cleaner - 1 Gallon Container

Part Number - 351097-164



### Fire Extinguisher Do Not Block

| Part Number | Size      |
|-------------|-----------|
| 351097-229  | 24"       |
| 351097-206  | 24" x 36" |



351097-229



351097-206

### Trash Can 24"

Part Number - 351097-224



### First Aid Kit Do Not Block 24"

Part Number - 351097-230



### Personal Protection Equipment Must Be Worn At All Times 24"

Part Number - 351097-233



### Emergency Eye Wash 24"

Part Number - 351097-228



### Safety Glasses Required

| Part Number | Size |
|-------------|------|
| 351097-369  | 12"  |
| 351097-370  | 16"  |
| 351097-371  | 24"  |
| 351097-372  | 36"  |



### Keep Clear Do Not Block Sign

| Part Number | Size      |
|-------------|-----------|
| 351097-208  | 24" x 36" |
| 351097-232  | 24" x 24" |



### Yellow Forklift Traffic 24"

Part Number - 351097-231



### Keep Clear Electrical Panel 24" x 36"

Part Number - 351097-207



### Orange Crown Forklift Traffic 17"

Part Number - 351097-210



### Yellow Pedestrian Sign 24"

Part Number - 351097-209



### Caution Door Swing Area 36"

Part Number - 351097-234



### Safety Stop Sign

| Part Number | Size |
|-------------|------|
| 351097-203  | 16"  |
| 351097-204  | 18"  |
| 351097-205  | 24"  |
| 351097-223  | 48"  |



## Floor Signs

**Employees Only**

| Part Number | Size |
|-------------|------|
| 351097-376  | 12"  |
| 351097-377  | 16"  |



**Practice Social Distancing**

| Part Number | Size |
|-------------|------|
| 351097-374  | 12"  |
| 351097-375  | 16"  |



**No Entry Beyond This Point**

| Part Number | Size |
|-------------|------|
| 351097-378  | 12"  |
| 351097-379  | 16"  |



**Maintain Distance**

| Part Number | Size |
|-------------|------|
| 351097-381  | 16"  |



**Wait Here**

| Part Number | Size |
|-------------|------|
| 351097-383  | 12"  |
| 351097-384  | 16"  |



**Keep Safe Distance**

| Part Number   | Size     |
|---------------|----------|
| 351097-382-01 | 4" x 36" |



## Ladders and Platforms

**Telescopic Ladder\***

Design allows for storage in closets or tight spaces. Spring loaded locking pin automatically engages to secure step height. Bumper guards and molded rubber feet protects walls and floors.



360039-2002

| Part Number | Extended Steps | Closed Size (W x D x H) | Step Depth | Cap. (lbs.) | Wt. (lbs.) |
|-------------|----------------|-------------------------|------------|-------------|------------|
| 360039-2002 | 6" - 10'       | 18.5" x 2.75" x 29"     | 1½"        | 225         | 24         |
| 360039-2003 | 6" - 12'       | 19.25" x 3.5" x 32"     | 1½"        | 225         | 30         |

**Steel Work Platform\***

| Part Number | Description |
|-------------|-------------|
| 360039-056  | 36" x 36"   |
| 360039-057  | 36" x 48"   |
| 360039-058  | 48" x 48"   |



360039-057

**Notice:** Occupant safety depend on maintaining a work platform in level, horizontal position. Only use work platform on improved surfaces (asphalt or concrete) that are even and level. DO NOT mount a work platform on a telehandler, boom lift or rough terrain forklift, even if the handler will be used on level concrete or asphalt.

**Fiberglass Multi-Purpose Ladder\*\***

Dark Horse Model 13 easily changes to a stepladder, extension ladder, or 2 scaffold bases. All configurations of this ladder have telescoping capabilities. Wide flared base for stability. Super-lightweight, super-strong, non-conductive fiberglass composite. ANSI Type IAA and Type 1A duty rating.

| Part No. | Load Cap. | Extension Max Ht. | Step Ladder Ht. | Scaffold Ht. | Bottom Width |
|----------|-----------|-------------------|-----------------|--------------|--------------|
| 360052   | 375 lbs.  | 11'               | 3'6" - 5'6"     | 1' - 3'      | 29"          |



\*\*Available for all customers

\*Available only to customers in USA

# Pallets and Accessories

## Galvanized Steel Pallets\*

**Finished Steel:** Galvanized finish is rust resistant. Unit has a two-way entry allowing fork truck access only. Heavy-duty, non-reversible welded steel.

**Welded Wire:** Welded steel wire pallet. Galvanized finish. Unit has a four-way entry. Heavy-duty, non-reversible welded steel.

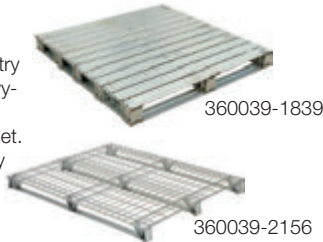

| Part Number | Description               | Dimensions |
|-------------|---------------------------|------------|
| 360039-1839 | Galvanized Finished Steel | 48" x 48"  |
| 360039-2156 | Galvanized Welded Wire    | 40" x 48"  |
| 360039-2157 | Galvanized Welded Wire    | 48" x 48"  |

**WARNING:** Cancer and reproductive harm - [www.P65Warnings.ca.gov](http://www.P65Warnings.ca.gov)

## Heavy-Duty Aluminum Pallets\*

Aluminum Pallet works great in food and chemical industries. Unique design stands up to high-power steam, brushes, or pads. Non-skid surface provides easy transportation of all products. Two-way entry for pallet provides visibility.



| Part Number | Description         | Dimensions |
|-------------|---------------------|------------|
| 360039-2520 | Heavy-Duty Aluminum | 40" x 48"  |
| 360039-2524 | Heavy-Duty Aluminum | 48" x 48"  |

## Pallet Busters\*

Gets rid of broken pallets quickly and safely. Can also be used for dockboard removal. Designed for disassembling pallets easily.

**Silver/Regular:** Lightweight. Features dual prying action with nail puller.

**Blue/Deluxe:** Articulating head won't break or split the wood.



| Part Number | Description      |
|-------------|------------------|
| 360039-1788 | Silver - Regular |
| 360039-1789 | Blue - Deluxe    |

## Pallet Jockey\*

Part Number - 360039-107

The adjustable unit is designed to fit various types of electric pallet jacks. To use simply loosen wing bolts and slide adjustable brack to proper slot, then tighten wing bolts. Weight 28 lbs. Maximum Capacity 4,000 lbs.



## Yellow Economical Pallet Truck Caddy\*

Part Number - 360039-072



## Pallet Puller - 5000 lb. Capacity\*



| Part Number | Description                | Jaw Opening |
|-------------|----------------------------|-------------|
| 360039-052  | Single Scissor             | 7"          |
| 360039-053  | Cam Action                 | 3"          |
| 360039-054  | Double Scissor             | 3"          |
| 360039-055  | Low Profile Double Scissor | 3 1/2"      |

## Aluminum Pallet Dolly w/Tilt\*



| Part Number | Description                           |
|-------------|---------------------------------------|
| 360039-065  | 4,000 lb Capacity, 6 Rollers, 40"x48" |
| 360039-066  | 6,000 lb Capacity, 8 Rollers, 40"x48" |

\*Available only to customers in USA

## Wheel Chocks\*

Reinforced rubber resists tearing, abrasion and ozone weathering. Rubber provides a sure grip on virtually any surface.



| Part Number | Type                    | Dimensions               |
|-------------|-------------------------|--------------------------|
| 360039-004  | Laminated Rubber        | 10" x 5.5" x 10"         |
| 360039-005  | Laminated Rubber        | 10" x 5.5" x 10" w/grips |
| 360039-006  | Laminated Rubber        | 8" x 8" x 8"             |
| 360039-001  | Molded Rubber (Eyebolt) | 9.25" x 6" x 8"          |
| 360039-002  | Molded Rubber (Handle)  | 9.25" x 6" x 8"          |
| 360039-003  | Molded Rubber (Orange)  | 9.25" x 6" x 8"          |
| 360039-044  | Aluminum                | 10" x 7" x 8"            |

## Wheel Chock\*\*

Part Number - 340094-004  
3" x 4.9" x 2.6"



\*\*Available for all customers

## Wheel Chock\*\*

Part Number - 340094-003  
5" x 4" x 8"



\*\*Available for all customers

## Industrial Rubber Wedge\*

Part Number - 360039-1624  
24" x 6.75" x 3"

Rubber wedge resilience avoids creasing or wrinkling paper. Increases its grip as weight is increased.



## Wheel Chock - Small\*\*

Part Number - 340094-001  
3" x 2.5" x 3"



\*\*Available for all customers

## Blocking Outrigger - Large\*\*

Part Number - 340094-002  
5.8" x 3.6" x 9.5"



\*\*Available for all customers

## Double Wheel Chock\*\*

Part Number - 340094-006  
9.5" x 5.9" x 3.6"



\*\*Available for all customers

## Pallet Truck Stop\*

Part Number - 360039-106

Secures pallet truck wheel.



## Car Stop - Recycled Plastic 72"\*

| Part Number | Description |
|-------------|-------------|
| 360039-041  | Blue        |
| 360039-042  | Gray        |
| 360039-043  | Yellow      |



360039-043

\*Available only to customers in USA

Check out Crown's selection of aerosols. See Section 1.



# Wheel Chocks

## Ergonomic Handle Wheel Chocks\*

Reinforced rubber resists tearing, abrasion and ozone weathering. Rubber provides a sure grip on virtually any surface.



| Part Number | Type                       | Dimensions         |
|-------------|----------------------------|--------------------|
| 360039-1219 | Laminated Rubber           | 9.5" x 5.5" x 10"  |
| 360039-1335 | Orange Molded Rubber Chock | 9.25" x 6" x 8"    |
| 360039-1689 | Black Molded Rubber Chock  | 9.25" x 6" x 8"    |
| 360039-875  | Fabricated Steel           | 10" x 8.25" x 9.5" |
| 360039-876  | Fabricated Steel           | 8" x 9" x 10.75"   |

## Rail Chocks\*

Single steel rail chock design fits most standard size rails. Heavy-duty welded steel construction provides maximum durability & strength. Rubber hand grips included for a non-slip grip.



| Part Number | Type                                      |
|-------------|---|
| 360039-5885 | Single Rail Chock/Flag Rail Chock Combo   |
| 360039-5886 | Single Rail Chock/Single Rail Chock Combo |

## Chain & Hanger Kit (15')\*

Part Number - 360039-007



\*Available only to customers in USA

# Jacks

Continued ▶

## Trailer Stability Jack\*

Used to prevent up-ending semi-trailers when they are not connected to a tractor during loading and unloading operations. Features: High strength steel construction. Reflective collar increases visibility at night. Unique design levels trailers parked on sloped ground. Powder-coat safety yellow. Handle color may vary. Meets OSHA regulations when used with wheel chocks.



| Part Number | Description               | Static Capacity (lbs) | Lifting Capacity (lbs) | Service Range | Wheel Size & Type   | Wt. (lbs) |
|-------------|---------------------------|-----------------------|------------------------|---------------|---------------------|-----------|
| 360039-045  | Economy (Rounded Base)    | 50,000                | 5,000                  | 44" to 51"    | None                | 39        |
| 360039-085  | Economy                   | 50,000                | 5,000                  | 44" to 51"    | None                | 39        |
| 360039-084  | Economy (Flat Base)       | 50,000                | 5,000                  | 44" to 51"    | None                | 44        |
| 360039-074  | Economy                   | 50,000                | 5,000                  | 41" to 57.5"  | 8" hard rubber      | 102       |
| 360039-067  | Ratchet                   | 100,000               | 40,000                 | 45" to 57"    | 10" hard rubber     | 141       |
| 360039-068  | Ratchet Jack              | 100,000               | 40,000                 | 39" to 51"    | 10" hard rubber     | 137       |
| 360039-075  | Spin Top                  | 100,000               | 40,000                 | 39.5" to 51"  | 10" hard rubber     | 129       |
| 360039-086  | Big Foot Stabilizing Jack | 100,000               | 40,000                 | 39.5" to 51"  | 10" hard rubber     | 162       |
| 360039-087  | Ratchet Beam Jack         | 100,000               | 40,000                 | 40" to 51"    | 10"x2" hard rubber  | 182       |
| 360039-088  | Spin Top Beam             | 100,000               | 40,000                 | 40" to 51"    | 10"x2" hard rubber  | 200       |
| 360039-089  | Hydraulic Beam Jack       | 100,000               | 40,000                 | 41" to 47"    | 10"x2" hard rubber  | 175       |
| 360039-090  | Hand Crank                | 100,000               | 50,000                 | 41" to 55"    | 16" Solid Foam      | 238       |
| 360039-091  | Hand Crank                | 100,000               | 50,000                 | 41" to 55"    | 16" fully pneumatic | 221       |

\*Available only to customers in USA

# Jacks

## Trailer Jack\*

Use for a wide variety of leveling and adjustment applications. Ideal for industrial or agricultural equipment trailers. Bracket attaches in a variety of ways in order to meet needs.



| Part Number | Type      | Capacity  |
|-------------|-----------|-----------|
| 360039-2000 | Tube Ring | 2000 lbs. |

## Mechanical Machinery Jack\*

Compact design with collapsible lever. Self-locking, anti-kickback operating lever. Lifting and lowering speeds are controllable for easy operation. Will not drift down even after an extended period of time.

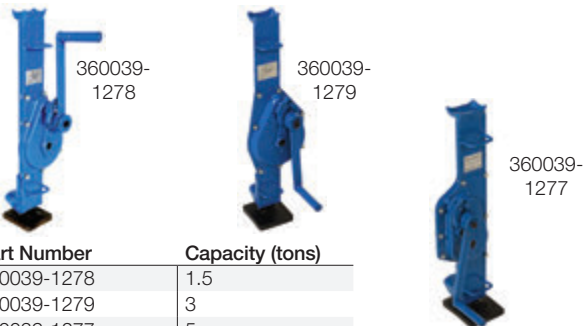

| Part Number | Capacity (tons) |
|-------------|-----------------|
| 360039-1278 | 1.5             |
| 360039-1279 | 3               |
| 360039-1277 | 5               |

## Mechanical Screw Jack\*

Mechanical screw jack is for loading dock equipment. Acme thread post supports the load.

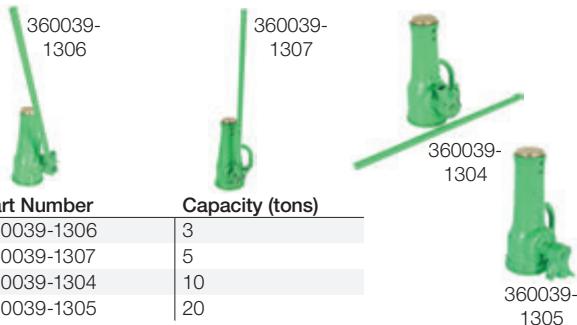

| Part Number | Capacity (tons) |
|-------------|-----------------|
| 360039-1306 | 3               |
| 360039-1307 | 5               |
| 360039-1304 | 10              |
| 360039-1305 | 20              |

## Heavy Duty Ratchet Farm Jack - 3.5 Ton Capacity\*

Farm jack design lifts, pulls, and pushes heavy machinery and objects. Hydraulic free with full lever mechanical operation. Heavy-duty ratchet operating lever.



| Part Number | Raised Height |
|-------------|---------------|
| 360039-1018 | 42"           |
| 360039-1019 | 53"           |

## Cargo Bar\*



| Part Number | Description                        |
|-------------|------------------------------------|
| 360039-060  | Aluminum - 1 Piece Heavy Duty      |
| 360039-061  | Steel - 1 Piece With Hoops         |
| 360039-062  | Galvanized Steel- 1 Piece          |
| 360039-063  | Galvanized Steel - 2 Piece Folding |
| 360039-064  | Galvanized - 2 Piece Telescopic    |

**WARNING:** Cancer and reproductive harm - [www.P65Warnings.ca.gov](http://www.P65Warnings.ca.gov)

## Steel Prylever Bars - 5000 lb. Capacity\*

Prylever bar design provides needed leverage. Thick steel nose plate with beveled edge. Poly-on-steel wheels. Powder-coated steel construction.

| Part Number | Length |
|-------------|--------|
| 360039-5516 | 5'     |
| 360039-5517 | 6'     |
| 360039-5518 | 7'     |



## Wood Prylever Bars - 4250 lb. Capacity\*

Prylever bar design provides needed leverage. Thick steel nose plate with beveled edge. Poly-on-steel wheels.

| Part Number | Length |
|-------------|--------|
| 360039-5519 | 5'     |
| 360039-5520 | 6'     |
| 360039-5521 | 7'     |



## King Pin Lock\*

Part Number - 360039-094

Trailer king pin lock provides security for trailers and RVs. No tools are required. Lock is powder-coated yellow; comes with two keys.



## Stable Jack Notice Sign\*

Part Number - 360039-092



## Drivers Instruction Sign\*

Part Number - 360039-093



\*Available only to customers in USA

# Hand Trucks

## P-Handle Hand Trucks\*

The P-Handle Hand Truck is ideal for transporting heavy and awkward loads. This truck works well for the user that needs to free up one hand. The "P" shaped handle makes the truck easy to steer and maneuver.



360039-229



360039-228



360039-1830



360039-1831



360039-1827



360039-1833

| Part Number | Description                          | Capacity (lbs.) |
|-------------|--------------------------------------|-----------------|
| 360039-229  | Aluminum - Hard Rubber Wheels        | 500             |
| 360039-228  | Aluminum - Pneumatic Wheels          | 500             |
| 360039-1830 | Steel - Pneumatic Wheels             | 600             |
| 360039-1831 | Steel - Hard Rubber Wheels           | 600             |
| 360039-1833 | Stainless Steel - Pneumatic Wheels   | 500             |
| 360039-1827 | Stainless Steel - Hard Rubber Wheels | 600             |

\*Available only to customers in USA



### Personal Hand Truck

Part Number - 322300-001

150 lb. load capacity. Opens and closes in seconds. Extends to 39" tall. Compacts to 25" tall and 2.5" thick. 15" wide aluminum base plate. 5" rubber wheels. No assembly required. Weight: 7.2 lbs.



### Personal Hand Truck

Part Number - 322300-002

200 lb. load capacity. Opens and closes in seconds. Extends to 39" tall. Compacts to 28.5" tall and 2.5" thick. Extra wide 19.25" aluminum base plate. Rugged 22mm steel frame. 7" rubber wheels. No assembly required. Weight: 10.5 lbs.

WAREHOUSE

CROWN

V-FORCE

## Save Time And Money Using the V-Force® Battery Watering System.

- Reduces filling time by up to 75 percent when compared to a watering gun.
- Extends battery life by preventing over and under watering.
- Unique push-fit tubing resists kinks or crushing.
- Valves fill all cells to the appropriate level.
- Wide range of operating pressure, 3-45 psi.

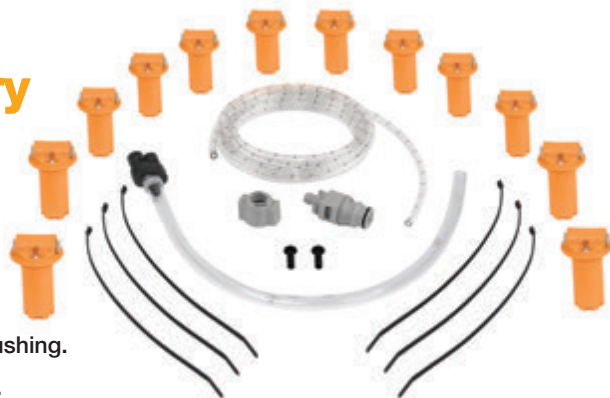

See Battery and Charger Section



## Self-Dumping Hoppers with Bumper Release

Automatically dumps when cushioned bumper release contacts front of the dumpster. Must be attached to fork truck when dumping. Safety restraint is provided to secure the hopper to the fork truck. Cable included to manually dump hopper from seat of truck. Returns to upright and locked position when lowered to the ground. Usable fork pockets measure 7"W x 2"H. Color: Blue. Powder Coat Paint. Additional colors are available.



### D Style\*

| Part Number                         | Volume<br>Cubic Yards | Capacity (lbs) | Overall (W x L x H)  | Fork Pocket<br>Centers | Wt.<br>(lbs) |
|-------------------------------------|-----------------------|----------------|--|------------------------|--------------|
| <b>Light Duty - 12 Gauge Steel</b>  |                       |                |  |                        |              |
| 360039-7048                         | ¼                     | 2,000          | 26" x 51 <sup>7</sup> / <sub>8</sub> " x 38"   | 18"                    | 335          |
| 360039-7054                         | ½                     | 2,000          | 26" x 51 <sup>7</sup> / <sub>8</sub> " x 38"   | 18"                    | 340          |
| 360039-7058                         | ¾                     | 2,000          | 33 <sup>1</sup> / <sub>16</sub> " x 51 <sup>3</sup> / <sub>4</sub> " x 38"                                 | 18"                    | 365          |
| 360039-7061                         | 1                     | 2,000          | 31 <sup>1</sup> / <sub>16</sub> " x 61 <sup>1</sup> / <sub>8</sub> " x 42 <sup>1</sup> / <sub>16</sub> "   | 18"                    | 449          |
| 360039-7036                         | 1                     | 2,000          | 41 <sup>1</sup> / <sub>16</sub> " x 61 <sup>1</sup> / <sub>8</sub> " x 42 <sup>1</sup> / <sub>16</sub> "   | 18"                    | 479          |
| 360039-7039                         | 1½                    | 2,000          | 43 <sup>1</sup> / <sub>16</sub> " x 68 <sup>5</sup> / <sub>16</sub> " x 51 <sup>13</sup> / <sub>16</sub> " | 28"                    | 565          |
| 360039-7042                         | 2                     | 2,000          | 56 <sup>1</sup> / <sub>16</sub> " x 68 <sup>5</sup> / <sub>16</sub> " x 51 <sup>13</sup> / <sub>16</sub> " | 28"                    | 613          |
| 360039-7045                         | 2½                    | 2,000          | 69 <sup>9</sup> / <sub>16</sub> " x 68 <sup>5</sup> / <sub>16</sub> " x 51 <sup>3</sup> / <sub>4</sub> "   | 28"                    | 863          |
| 360039-7051                         | 3                     | 2,000          | 81 <sup>3</sup> / <sub>4</sub> " x 68 <sup>5</sup> / <sub>16</sub> " x 51 <sup>13</sup> / <sub>16</sub> "  | 28"                    | 940          |
| <b>Medium Duty - 10 Gauge Steel</b> |                       |                |  |                        |              |
| 360039-7049                         | ¼                     | 4,000          | 26" x 51 <sup>7</sup> / <sub>8</sub> " x 38 <sup>1</sup> / <sub>16</sub> "                                 | 18"                    | 397          |
| 360039-7055                         | ½                     | 4,000          | 26" x 51 <sup>7</sup> / <sub>8</sub> " x 38 <sup>1</sup> / <sub>16</sub> "                                 | 18"                    | 397          |
| 360039-7059                         | ¾                     | 4,000          | 33 <sup>9</sup> / <sub>16</sub> " x 51 <sup>7</sup> / <sub>8</sub> " x 38 <sup>1</sup> / <sub>16</sub> "   | 18"                    | 435          |
| 360039-7062                         | 1                     | 4,000          | 31 <sup>9</sup> / <sub>16</sub> " x 61 <sup>1</sup> / <sub>8</sub> " x 42 <sup>3</sup> / <sub>4</sub> "    | 18"                    | 543          |
| 360039-7037                         | 1                     | 4,000          | 41 <sup>1</sup> / <sub>2</sub> " x 61 <sup>1</sup> / <sub>8</sub> " x 42 <sup>1</sup> / <sub>16</sub> "    | 18"                    | 534          |
| 360039-7040                         | 1½                    | 4,000          | 43 <sup>9</sup> / <sub>16</sub> " x 68 <sup>5</sup> / <sub>16</sub> " x 51 <sup>13</sup> / <sub>16</sub> " | 28"                    | 714          |
| 360039-7043                         | 2                     | 4,000          | 56 <sup>5</sup> / <sub>16</sub> " x 68 <sup>5</sup> / <sub>16</sub> " x 51 <sup>13</sup> / <sub>16</sub> " | 28"                    | 701          |
| 360039-7046                         | 2½                    | 4,000          | 69 <sup>9</sup> / <sub>16</sub> " x 68 <sup>5</sup> / <sub>16</sub> " x 51 <sup>3</sup> / <sub>4</sub> "   | 28"                    | 863          |
| 360039-7052                         | 3                     | 4,000          | 81 <sup>3</sup> / <sub>4</sub> " x 68 <sup>5</sup> / <sub>16</sub> " x 51 <sup>13</sup> / <sub>16</sub> "  | 28"                    | 940          |
| <b>Heavy Duty - 8 Gauge Steel</b>   |                       |                |  |                        |              |
| 360039-7047                         | ¼                     | 6,000          | 26" x 51 <sup>7</sup> / <sub>8</sub> " x 38 <sup>1</sup> / <sub>16</sub> "                                 | 18"                    | 397          |
| 360039-7053                         | ½                     | 6,000          | 26" x 51 <sup>7</sup> / <sub>8</sub> " x 38 <sup>1</sup> / <sub>16</sub> "                                 | 18"                    | 397          |
| 360039-7057                         | ¾                     | 6,000          | 33 <sup>9</sup> / <sub>16</sub> " x 51 <sup>7</sup> / <sub>8</sub> " x 38 <sup>1</sup> / <sub>16</sub> "   | 18"                    | 435          |
| 360039-7060                         | 1                     | 6,000          | 31 <sup>9</sup> / <sub>16</sub> " x 61 <sup>1</sup> / <sub>8</sub> " x 42 <sup>3</sup> / <sub>4</sub> "    | 18"                    | 543          |
| 360039-7035                         | 1                     | 6,000          | 41 <sup>1</sup> / <sub>16</sub> " x 61 <sup>1</sup> / <sub>8</sub> " x 42 <sup>3</sup> / <sub>4</sub> "    | 18"                    | 572          |
| 360039-7038                         | 1½                    | 6,000          | 43 <sup>9</sup> / <sub>16</sub> " x 68 <sup>5</sup> / <sub>16</sub> " x 51 <sup>13</sup> / <sub>16</sub> " | 28"                    | 714          |
| 360039-7041                         | 2                     | 6,000          | 56 <sup>9</sup> / <sub>16</sub> " x 68 <sup>5</sup> / <sub>16</sub> " x 51 <sup>13</sup> / <sub>16</sub> " | 28"                    | 767          |
| 360039-7044                         | 2½                    | 6,000          | 69 <sup>9</sup> / <sub>16</sub> " x 68 <sup>5</sup> / <sub>16</sub> " x 51 <sup>3</sup> / <sub>4</sub> "   | 28"                    | 863          |
| 360039-7050                         | 3                     | 6,000          | 81 <sup>3</sup> / <sub>4</sub> " x 68 <sup>5</sup> / <sub>16</sub> " x 51 <sup>13</sup> / <sub>16</sub> "  | 28"                    | 940          |
| 360039-7056                         | 3½                    | 6,000          | 64 <sup>1</sup> / <sub>4</sub> " x 79 <sup>3</sup> / <sub>8</sub> " x 64 <sup>3</sup> / <sub>8</sub> "     | 28"                    | 1128         |
| 360039-3743                         | 4                     | 6,000          | 72 <sup>15</sup> / <sub>16</sub> " x 79 <sup>3</sup> / <sub>8</sub> " x 64 <sup>3</sup> / <sub>8</sub> "   | 28"                    | 1445         |



360039-7051



360039-7043



360039-7056

### H Style - Low Profile 90 degrees\*

| Part Number | Volume<br>Cubic Yards | Capacity (lbs) | Overall (WxLxH)  | Fork Pockets                     | Wt. (lbs) |
|-------------|-----------------------|----------------|--|----------------------------------|-----------|
| 360039-7102 | 1                     | 2,000          | 51" x 51 <sup>3</sup> / <sub>16</sub> " x 28 <sup>1</sup> / <sub>8</sub> " | 21 <sup>5</sup> / <sub>8</sub> " | 311       |
| 360039-7103 | 1                     | 4,000          | 51" x 51 <sup>3</sup> / <sub>16</sub> " x 28 <sup>1</sup> / <sub>8</sub> " | 21 <sup>5</sup> / <sub>8</sub> " | 362       |
| 360039-7101 | 1                     | 6,000          | 51" x 51 <sup>1</sup> / <sub>4</sub> " x 28 <sup>3</sup> / <sub>16</sub> " | 21 <sup>5</sup> / <sub>8</sub> " | 398       |
| 360039-7105 | 1½                    | 4,000          | 51" x 56 <sup>1</sup> / <sub>16</sub> " x 38 <sup>5</sup> / <sub>8</sub> " | 21 <sup>5</sup> / <sub>8</sub> " | 435       |
| 360039-7104 | 1½                    | 6,000          | 51" x 56 <sup>1</sup> / <sub>2</sub> " x 38 <sup>1</sup> / <sub>16</sub> " | 21 <sup>5</sup> / <sub>8</sub> " | 472       |



360039-7105

⚠ **WARNING:** Cancer and reproductive harm - [www.P65Warnings.ca.gov](http://www.P65Warnings.ca.gov)

### Portable Steel Hoppers\*

Includes: foot operated caster lock, cable to manually dump hopper from seat of truck, and handle for transporting. Units must be attached to fork truck when dumping. Usable fork pockets measure 7"W x 2"H. Color: Blue. Powder Coat Paint.



| Part Number | Volume<br>Cubic Yards | Capacity (lbs) | Overall (WxLxH)  | Fork Pockets                     | Wt. (lbs) |
|-------------|-----------------------|----------------|--|----------------------------------|-----------|
| 360039-5505 | ½                     | 2,000          | 34 <sup>3</sup> / <sub>16</sub> " x 53 <sup>7</sup> / <sub>8</sub> " x 37 <sup>1</sup> / <sub>16</sub> "   | 21 <sup>5</sup> / <sub>8</sub> " | 262       |
| 360039-5506 | 1                     | 2,000          | 58 <sup>13</sup> / <sub>16</sub> " x 53 <sup>3</sup> / <sub>8</sub> " x 37 <sup>1</sup> / <sub>16</sub> "  | 21 <sup>5</sup> / <sub>8</sub> " | 389       |
| 360039-5507 | 1½                    | 2,000          | 58 <sup>13</sup> / <sub>16</sub> " x 58 <sup>15</sup> / <sub>16</sub> " x 47 <sup>5</sup> / <sub>8</sub> " | 21 <sup>5</sup> / <sub>8</sub> " | 440       |



360039-5505

⚠ **WARNING:** Cancer and reproductive harm - [www.P65Warnings.ca.gov](http://www.P65Warnings.ca.gov)

# Hoppers

## Low Profile Parts Hopper \*

The low profile design allows the hoppers to be placed underneath machinery as a catch basin for parts. Must be attached to fork truck when dumping. Returns to upright and locked position when lowered to the ground. Usable fork pockets measure 7"W x 2"H. Includes removable push handle. Color: Blue. Powder Coat Paint.



360039-4735



| Part Number | Volume      |                | Overall (W x L x H)       | Fork Pockets | Wt. (lbs) |   |
|-------------|-------------|----------------|---------------------------|--------------|-----------|---|
|             | Cubic Yards | Capacity (lbs) |                           |              |           |   |
| 360039-4736 | 1/5         | 2,000          | 29 13/16" x 54" x 33 5/8" | 11 1/2"      | 199       | (3) wheels: (2) rigid and (1) swivel with brake             |
| 360039-4735 | 1/2         | 2,000          | 48 7/16" x 54 1/16" x 34" | 21 1/2"      | 340       | (4) wheels: (2) rigid, (1) swivel and (1) swivel with brake |

⚠️ **WARNING:** Cancer and reproductive harm - [www.P65Warnings.ca.gov](http://www.P65Warnings.ca.gov)

## Casters for Self-Dumping Hoppers \*

Transport loads with portable hoppers. The maximum weight capacity is the lowest weight capacity of either the hopper or the caster. Weight of hopper must be considered when calculating usable capacity. Sets include (2) rigid and (2) swivel casters. For the H series 1/4 and 1/2 cubic yard hoppers only (3) casters included: (2) rigid and (1) swivel, and bolt on stabilizing legs for the back. Casters are bolted on by utilizing the factory stamped hole in the fork tubes. Casters are shipped uninstalled to prevent freight damage.



| Part Number    | For Use With Hopper Style | Caster Size | Uniform Capacity | Caster Description | Qty per Order | Wt. (lbs) |
|----------------|---------------------------|-------------|------------------|--------------------|---------------|-----------|
| <b>H Style</b> |                           |             |                  |                    |               |           |
| 360039-7219    | H                         | 6" X 2"     | 1,800 lb.        | Mold-on-Rubber     | 3             | 25        |
| 360039-7222    | H                         | 6" X 2"     | 2,400 lb.        | Mold-on-Rubber     | 4             | 28        |
| 360039-7218    | H                         | 6" X 2"     | 3,600 lb.        | Semi-Steel         | 3             | 27        |
| 360039-7220    | H                         | 6" X 2"     | 3,600 lb.        | Poly-on-Steel      | 3             | 26        |
| 360039-7353    | H                         | 6" X 2"     | 3,600 lb.        | Glass Filled Nylon | 3             | 17        |
| 360039-7221    | H                         | 6" X 2"     | 4,800 lb.        | Semi-Steel         | 4             | 31        |
| 360039-7223    | H                         | 6" X 2"     | 4,800 lb.        | Poly-on-Steel      | 4             | 30        |
| 360039-7355    | H                         | 6" X 2"     | 4,800 lb.        | Glass Filled Nylon | 4             | 18        |
| 360039-7354    | H                         | 6" X 2"     | 6,000 lb.        | Ductile Steel      | 3             | 35        |
| 360039-7356    | H                         | 6" X 2"     | 8,000 lb.        | Ductile Steel      | 4             | 42        |



360039-7357

Note: Maximum caster diameter permitted is 6". Added height to hopper for 6" casters is 3 3/4".

| <b>D Style</b> |                           |             |                  |                    |               |           |
|----------------|---------------------------|-------------|------------------|--------------------|---------------|-----------|
| Part Number    | For Use With Hopper Style | Caster Size | Uniform Capacity | Caster Description | Qty per Order | Wt. (lbs) |
| 360039-7226    | D                         | 6" X 2"     | 2,400 lb.        | Mold-on-Rubber     | 4             | 29        |
| 360039-7224    | D                         | 6" X 2"     | 4,800 lb.        | Semi-Steel         | 4             | 32        |
| 360039-7228    | D                         | 6" X 2"     | 4,800 lb.        | Poly-on-Steel      | 4             | 31        |
| 360039-7357    | D                         | 6" X 2"     | 4,800 lb.        | Glass Filled Nylon | 4             | 19        |
| 360039-7359    | D                         | 6" X 2"     | 8,000 lb.        | Ductile Steel      | 4             | 43        |
| 360039-7227    | D                         | 8" X 2"     | 2,400 lb.        | Mold-on-Rubber     | 4             | 37        |
| 360039-7225    | D                         | 8" X 2"     | 4,800 lb.        | Semi-Steel         | 4             | 42        |
| 360039-7229    | D                         | 8" X 2"     | 5,000 lb.        | Poly-on-Steel      | 4             | 42        |
| 360039-7358    | D                         | 8" X 2"     | 5,000 lb.        | Glass Filled Nylon | 4             | 22        |

Note: Maximum caster diameter permitted is 8". Added height to hopper for 6" casters is 7 1/2" and for 8" casters is 9 1/2".

⚠️ **WARNING:** Cancer and reproductive harm - [www.P65Warnings.ca.gov](http://www.P65Warnings.ca.gov)

## Heavy Duty Poly Lids for D&H Series Hoppers \*

Heavy-duty virgin polyethylene material. Lightweight and easy to open. Includes a crown for water drainage and a ribbed design for strength.



| Part Number | For Use With Hopper Size | For Use With Hopper Style | Number of Pieces | Wt. (lbs) |
|-------------|--------------------------|---------------------------|------------------|-----------|
| 360039-7146 | 1/2                      | H                         | 1                | 57        |
| 360039-7342 | 1                        | H                         | 2                | 56        |
| 360039-7343 | 1 1/2                    | H                         | 2                | 61        |
| 360039-7344 | 1/4                      | D                         | 1                | 56        |
| 360039-7345 | 1/5                      | D                         | 1                | 57        |
| 360039-7346 | 1/2                      | D                         | 1                | 57        |
| 360039-7347 | 3/4                      | D                         | 1                | 58        |
| 360039-7348 | 1                        | D                         | 1                | 57        |
| 360039-7349 | 1 1/2                    | D                         | 1                | 58        |
| 360039-7350 | 2                        | D                         | 2                | 59        |
| 360039-7351 | 2 1/2                    | D                         | 2                | 59        |
| 360039-7352 | 3                        | D                         | 2                | 61        |

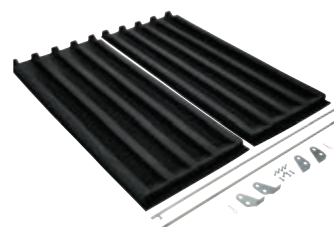

360039-7350

⚠️ **WARNING:** Cancer and reproductive harm - [www.P65Warnings.ca.gov](http://www.P65Warnings.ca.gov)

# Dockboards

## Aluminum Truck Dockboards with Steel Safety Curbs\*

High-strength aluminum treadplate material. Zinc-plated locking legs are within OSHA compliance. Beveled entrance and exit edges. Heavy-duty steel curbs are painted yellow, bolted to deckplate. Capacity is based upon the heaviest type of equipment used plus the maximum load carried times the single axle rating of total load.

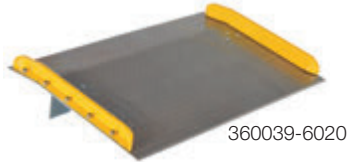

360039-6020

### 10,000 lb. capacity

| Part Number | Dimensions |
|-------------|------------|
| 360039-6020 | 54" x 36"  |
| 360039-6021 | 54" x 48"  |
| 360039-6022 | 54" x 60"  |
| 360039-6023 | 54" x 72"  |
| 360039-6024 | 60" x 36"  |
| 360039-6025 | 60" x 48"  |
| 360039-6026 | 60" x 60"  |
| 360039-6027 | 60" x 72"  |
| 360039-6028 | 72" x 36"  |
| 360039-6029 | 72" x 48"  |
| 360039-6030 | 72" x 60"  |
| 360039-6031 | 72" x 72"  |

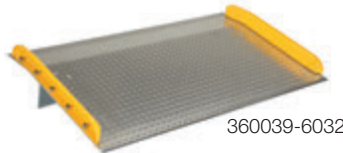

360039-6032

### 15,000 lb. capacity

| Part Number | Dimensions |
|-------------|------------|
| 360039-6032 | 54" x 36"  |
| 360039-6033 | 54" x 48"  |
| 360039-6034 | 54" x 60"  |
| 360039-6035 | 54" x 72"  |
| 360039-6036 | 60" x 36"  |
| 360039-6037 | 60" x 48"  |
| 360039-6038 | 60" x 60"  |
| 360039-6039 | 60" x 72"  |
| 360039-6040 | 72" x 36"  |
| 360039-6041 | 72" x 48"  |
| 360039-6042 | 72" x 60"  |
| 360039-6043 | 72" x 72"  |

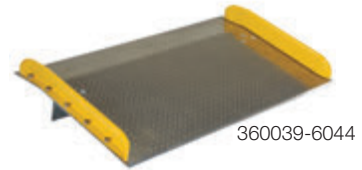

360039-6044

### 20,000 lb. capacity

| Part Number | Dimensions |
|-------------|------------|
| 360039-6044 | 60" x 36"  |
| 360039-6045 | 60" x 48"  |
| 360039-6046 | 60" x 60"  |
| 360039-6047 | 60" x 72"  |
| 360039-6048 | 72" x 36"  |
| 360039-6049 | 72" x 48"  |
| 360039-6050 | 72" x 60"  |
| 360039-6051 | 72" x 72"  |

## Fabricated Aluminum Hose & Cable Crossovers\*

Aluminum construction. Unique design protects wires and cords from traffic wear and tear. Tread plate. Lightweight design. All welded.

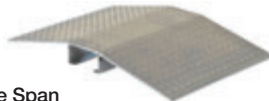

360039-4377

| Part Number | Overall Size | Usable Span |
|-------------|--------------|-------------|
| 360039-4377 | 24" x 36"    | 4" x 3"     |
| 360039-4378 | 24" x 36"    | 4" x 4"     |
| 360039-4379 | 24" x 40"    | 8" x 3"     |
| 360039-4380 | 24" x 40"    | 8" x 4"     |
| 360039-4381 | 24" x 44"    | 12" x 3"    |
| 360039-4382 | 24" x 44"    | 12" x 4"    |
| 360039-4383 | 24" x 48"    | 16" x 3"    |
| 360039-4384 | 24" x 48"    | 16" x 4"    |
| 360039-4385 | 48" x 36"    | 4" x 3"     |
| 360039-4386 | 48" x 36"    | 4" x 4"     |
| 360039-4387 | 48" x 40"    | 8" x 3"     |
| 360039-4388 | 48" x 40"    | 8" x 4"     |
| 360039-4389 | 48" x 44"    | 12" x 3"    |
| 360039-4390 | 48" x 44"    | 12" x 4"    |
| 360039-4391 | 48" x 48"    | 16" x 3"    |
| 360039-4392 | 48" x 48"    | 16" x 4"    |

## Tubes

### Bicycle/Tricycle Tubes\*\*

Part Number - 305006 ▼ OEM Reference  
24" x 2.125"

Part Number - 305007 ▼ OEM Reference  
26" x 2.125"  
Summit 26x2.125  
GRNG 2KGH3



\*\*Available for all customers

\*Available only to customers in USA

## Floor Mats



**Note:** see Tools Section. page 9.04, for Crown Bar Stools.



### Crown Branded Mats

| Part Number | Size     |
|-------------|----------|
| 368200-001  | 2' x 3'  |
| 368200-002  | 3' x 5'  |
| 368200-003  | 4' x 6'  |
| 368200-004  | 3' x 10' |

Use the Crown branded mats to make a lasting impression to your customers. Static dissipative nylon yarn treated with StainStopper™ Technology. 100% nitrile rubber backing for increased slip and resistance. Certified High-Traction by the National Floor Safety Institute.

### Tough Rib Floor Mat

Dirt-trapping design is uniquely built for heavy-traffic and high soil areas. Extra coarse polypropylene fibers stand up to demanding use. Vinyl backing and borders. Can be cleaned by vacuuming, sweeping or hosing.

| Part Number | Size     | Color    |
|-------------|----------|----------|
| 368200-202  | 3' x 5'  | Charcoal |
| 368200-203  | 4' x 6'  | Charcoal |
| 368200-204  | 3' x 10' | Charcoal |



**NEW!**

### Tire Tuff Royale High-Traffic Entrance Mat

Heavyweight floor mat designed for busy traffic areas – inside or out. Crush-resistant bi-level surface removes debris and moisture from passing shoes. Dual-fiber needle-punch mats dry quickly and resist staining and fading. Molded rubber backing for durability. Product contains 50% total recycled content.

| Part Number | Size    | Color |
|-------------|---------|-------|
| 368200-302  | 3' x 5' | Onyx  |

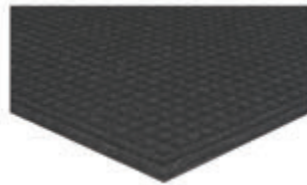

**NEW!**

### Unifirst Great Impressions 2.0 Walk-Off Floor Mat

Heavy-duty, nylon-tufted mat with stay-put "hugger" backing. Dense rubber back helps mat stay in place, reduce flex and improve durability. Absorbent surfaces trap and hold up to a gallon of water per square yard. Heavier weight helps hold mat in place and reduce potential for "flip-ups".

| Part Number | Size     | Color |
|-------------|----------|-------|
| 368200-102  | 3' x 5'  | Grey  |
| 368200-103  | 4' x 6'  | Grey  |
| 368200-104  | 3' x 10' | Grey  |

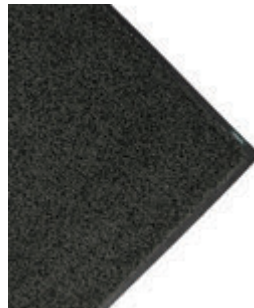

**NEW!**



### Power Unit 24V with Lift and Steer

| Part Number | Where Used              |
|-------------|-------------------------|
| B02-05-0034 | Telescopic Masts ESP 19 |



### 10" Drive Tire

| Part Number | Where Used              |
|-------------|-------------------------|
| B08-02-0029 | Telescopic Masts ESP 19 |



### Joysticks

| Part Number | Where Used              | Additional Info         |
|-------------|-------------------------|-------------------------|
| B01-10-0281 | Telescopic Masts ESP 19 | Assembly- Esp Rev 2     |
| B01-10-0264 | Telescopic Masts ESP 19 | With Enable Single Axis |
| E-00553     | Telescopic Masts ESP 19 | Esp Gen 4               |



### 8" Steer Tire

| Part Number | Where Used              |
|-------------|-------------------------|
| B08-02-0026 | Telescopic Masts ESP 19 |



### Starter Solenoid-24VDC-200AMP

| Part Number | Where Used              |
|-------------|-------------------------|
| B02-15-0425 | Telescopic Masts ESP 19 |



### Motor 24VDC

| Part Number | Where Used              |
|-------------|-------------------------|
| B02-15-0424 | Telescopic Masts ESP 19 |



### Retractable Cord 16-3 Yeltppe with Plugs

| Part Number | Where Used              |
|-------------|-------------------------|
| B01-01-0143 | Telescopic Masts ESP 19 |



### Cylinders

| Part Number | Where Used              | Additional Info        |
|-------------|-------------------------|------------------------|
| B02-03-0038 | Telescopic Masts ESP 19 | 1½" x 4" x ½" Steering |



### Potentiometer

| Part Number | Where Used   |
|-------------|--|
| 2505007020  | Telescopic Handlers HTL4017 / HTL9055, Telescopic Handlers HTL4014 / HTL9045, Telescopic Handlers HTL4010, Telescopic Handlers HTL3617 / HTL8055, Telescopic Handlers HTL3614 / HTL8045, Telescopic Handlers HTL3510, Telescopic Handlers HTL3210, HTL5210 / HTL11532, HTL3010 |



### Battery Charger 12V/25A Gas and Float

| Part Number |
|-------------|
| B01-05-0055 |



### Wheels

| Part Number | Description                            |
|-------------|--|
| E-00413     | 10" x 4" x 8", Gray                    |
| E-00437     | 12" x 4" x 10", Gray, Non-Marking, ESP |



### Switches

| Part Number | Where Used              | Additional Info          |
|-------------|-------------------------|--------------------------|
| B01-03-0065 | Telescopic Masts ESP 19 | No Push Button with Plug |
| B01-02-0082 | Telescopic Masts ESP 19 | Keyed Selector           |



### Key

| Part Number | Where Used   |
|-------------|--|
| B38-00-0001 | Towed Platforms HTT13PX / 3632T, Towed Platforms HTA16P / 4527A, Telescopic Masts ESP 19 |

# Biljax OEM Parts



### Cleviss Pin

| Part Number | Additional Info |
|-------------|-----------------|
| E-00512     | 6½" x ¾"        |



### Knuckle Plate

| Part Number | Where Used              |
|-------------|-------------------------|
| B07-08-0037 | Telescopic Masts ESP 19 |



0090-0420

0090-0428

0090-0425

0090-0574

### Washers

| Part Number | Where Used   | Additional Info     |
|-------------|--|---------------------|
| 0090-0420   | Towed Platforms HTA22P / 6543A, Telescopic Masts ESP 19, Electric Articulated Platforms HLA19PX / 55XA   | Flat, ⅝", Zinc, SAE |
| 0090-0428   | Telescopic Masts ESP 19  | Flat, ¾", Zinc, SAE |
| 0090-0425   | Towed Platforms HTT13PX / 3632T, Towed Platforms HTA22P / 6543A, Towed Platforms HTA19P / 5533A, Towed Platforms HTA16P / 4527A, Towed Platforms HTA13P / 3522A, Telescopic Masts ESP 19 | Flat, ⅝", Zinc, SAE |
| 0090-0574   | Telescopic Masts ESP 19  | Flat, ½", Zinc, SAE |



0090-1061



0090-1137



0090-0046



0090-0001



0096-0012



0096-0054

### Cap Screws

| Part Number | Where Used                           | Additional Info              |
|-------------|--------------------------------------|------------------------------|
| 0090-1061   | Telescopic Masts ESP 19              | 5/16-18 x 2                  |
| 0090-1137   | Telescopic Masts ESP 19              | 3/8-16 UNC x 3               |
| 0090-0046   | Telescopic Masts ESP 19              | 3/8-16 x 1 3/4               |
| 0090-0001   | Telescopic Masts Belone 800/900/1100 | 1/4-20 x 1/2                 |
| 0096-0012   | Towed Platforms Htt13Px / 3632T      | Flat Head, M8 x 25 mm        |
| 0096-0054   | —                                    | Flat Head, M16 x 50 mm, Zinc |



### Bushing

| Part Number | Where Used  |
|-------------|---|
| A-00056     | Towed Platforms HTT13PX / 3632T, Towed Platforms HTA22P / 6543A, Towed Platforms HTA16P / 4527A, Towed Platforms HTA13P / 3522A, Electric Articulated Platforms HLA19PX / 55XA, Electric Articulated Platforms HLA16PX / 45XA |



0090-0185



0090-0188



0096-0044

### Self-Locking Nuts

| Part Number | Where Used   | Additional Info |
|-------------|--|-----------------|
| 0090-0185   | Towed Platforms HTT13PX / 3632T, Towed Platforms HTA22P / 6543A, Towed Platforms HTA19P / 5533A, Towed Platforms HTA16P / 4527A, Towed Platforms HTA13P / 3522A, Telescopic Masts ESP 19, Electric Articulated Platforms HLA19PX / 55XA, Electric Articulated Platforms HLA16PX / 45XA | 5/16-18         |
| 0090-0188   | Telescopic Masts ESP 19  | 3/8-16, Nylon   |
| 0096-0044   | —  | —               |



**Battery 12CE100 Type S Genie**

| Part Number   | Additional Info  |
|---------------|--|
| 345012-100-SS | Aluminum Dry Battery, 12V GRP 27, 100 AH, Dimensions: 12.09L x 6.65W x 8.31H |

⚠ WARNING: Cancer and reproductive harm - [www.P65Warnings.ca.gov](http://www.P65Warnings.ca.gov)



**Two Switch Silicon Boot**

| Part Number |
|-------------|
| GN229093GT  |

⚠ WARNING: Cancer and reproductive harm - [www.P65Warnings.ca.gov](http://www.P65Warnings.ca.gov)



GN105454GT



GN105122GT



GN57998GT

**Wheel and Tire Assembly**

| Part Number | Additional Info                       |
|-------------|---------------------------------------|
| GN105454GT  | 15", Gray Non-Marking                 |
| GN105122GT  | 12", Gray Non-Marking                 |
| GN57998GT   | 10" x 3", Gray, Mould On, Non-Marking |

⚠ WARNING: Cancer and reproductive harm - [www.P65Warnings.ca.gov](http://www.P65Warnings.ca.gov)



**Brush Power Unit**

| Part Number | Additional Info               |
|-------------|-------------------------------|
| GN44751GT   | Four Required For Replacement |

⚠ WARNING: Cancer and reproductive harm - [www.P65Warnings.ca.gov](http://www.P65Warnings.ca.gov)



**Rubber Latch**

| Part Number | Additional Info   |
|-------------|---|
| GN57881GT   | 3 <sup>1</sup> / <sub>2</sub> x 1 <sup>1</sup> / <sub>8</sub> |

⚠ WARNING: Cancer and reproductive harm - [www.P65Warnings.ca.gov](http://www.P65Warnings.ca.gov)



**Function Pump, GS Slabs Bosch**

| Part Number |
|-------------|
| GN96193GT   |

⚠ WARNING: Cancer and reproductive harm - [www.P65Warnings.ca.gov](http://www.P65Warnings.ca.gov)



**Gas Shock Scissors**

| Part Number |
|-------------|
| GN39542GT   |

⚠ WARNING: Cancer and reproductive harm - [www.P65Warnings.ca.gov](http://www.P65Warnings.ca.gov)



GN78903GT



GN137634GT



GN62161GT

**Joystick Controllers**

| Part Number | Additional Info                   |
|-------------|-----------------------------------|
| GN78903GT   | Single Axis, Hall Effect Joystick |
| GN137634GT  | Single Axis, Hall Effect Joystick |
| GN62161GT   | —                                 |

⚠ WARNING: Cancer and reproductive harm - [www.P65Warnings.ca.gov](http://www.P65Warnings.ca.gov)



**Limit Switch with Roller Arm**

| Part Number |
|-------------|
| GN96948GT   |

⚠ WARNING: Cancer and reproductive harm - [www.P65Warnings.ca.gov](http://www.P65Warnings.ca.gov)

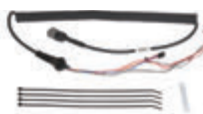

**Gen 5 Coil Cord Kit**

| Part Number |
|-------------|
| GN144065GT  |

⚠ WARNING: Cancer and reproductive harm - [www.P65Warnings.ca.gov](http://www.P65Warnings.ca.gov)



**Spring Rewind Cord Reel**

| Part Number |
|-------------|
| GN218073GT  |

⚠ WARNING: Cancer and reproductive harm - [www.P65Warnings.ca.gov](http://www.P65Warnings.ca.gov)



**Coil Cord-Joystick Slabs**

| Part Number |
|-------------|
| GN62223GT   |

⚠ WARNING: Cancer and reproductive harm - [www.P65Warnings.ca.gov](http://www.P65Warnings.ca.gov)



**Hinge, Spring, Long Leg**

| Part Number |
|-------------|
| GN104804GT  |

⚠ WARNING: Cancer and reproductive harm - [www.P65Warnings.ca.gov](http://www.P65Warnings.ca.gov)



**Solenoid Manual Valve**

| Part Number |
|-------------|
| GN66465GT   |

⚠ WARNING: Cancer and reproductive harm - [www.P65Warnings.ca.gov](http://www.P65Warnings.ca.gov)



**5" Link Bumper**

| Part Number |
|-------------|
| GN96735GT   |

⚠ WARNING: Cancer and reproductive harm - [www.P65Warnings.ca.gov](http://www.P65Warnings.ca.gov)



GN47098GT



GN47374GT

**Non-Skid Die Cut Tape**

| Part Number | Description |
|-------------|-------------|
| GN47098GT   | 4" x 40"    |
| GN47374GT   | 4" x 32"    |

⚠ WARNING: Cancer and reproductive harm - [www.P65Warnings.ca.gov](http://www.P65Warnings.ca.gov)

# Genie OEM Parts



## Blue Aerial Operator Access Card

Part Number  
GN76754GT

⚠️WARNING: Cancer and reproductive harm - [www.P65Warnings.ca.gov](http://www.P65Warnings.ca.gov)



GN1268GT GN1484GT

## Aerosol Paint

| Part Number | Description |
|-------------|-------------|
| GN1268GT    | Genie Gray  |
| GN1484GT    | Bright Blue |

⚠️WARNING: Cancer and reproductive harm - [www.P65Warnings.ca.gov](http://www.P65Warnings.ca.gov)



GN83093GT

## Keys

| Part Number | Additional Info |
|-------------|-----------------|
| GN83093GT   | Single Key      |
| B38-00-0001 | Single Key      |
| GN96011GT   | Keyswitch Kit   |

B38-00-0001



⚠️WARNING: Cancer and Reproductive Harm - [www.P65Warnings.ca.gov](http://www.P65Warnings.ca.gov)



GN82561GT



GN44737GT

## Decals

| Part Number | Description                 |
|-------------|-----------------------------|
| GN82561GT   | Use Safety Arm Danger Decal |
| GN44737GT   | Tip-Over Trays Danger Decal |

⚠️WARNING: Cancer and reproductive harm - [www.P65Warnings.ca.gov](http://www.P65Warnings.ca.gov)



GN100195GT

GN55021GT

## Power Cords

| Part Number | Description            |
|-------------|------------------------|
| GN100195GT  | 79" Power Cord, US 110 |
| GN55021GT   | 9" Power Cord, US 110  |

⚠️WARNING: Cancer and Reproductive Harm - [www.P65Warnings.ca.gov](http://www.P65Warnings.ca.gov)

## Grease

Three Varieties Available:



**High-Temp**  
Extreme pressure protection



**Multi-Purpose**  
Rust and corrosion protection



**Low-Temp**  
Excellent low temp pumpability

See Service Supplies Section

**one source**  
LIFT TRUCK PARTS



## Crown is Your One-Stop Shop

### Fall Protection Equipment

Including harnesses and lanyards

### Safety Apparel

Including ear and eye protection, face shields, safety vests, coveralls and hard hats

### Respiratory Equipment

Including respirators and masks

### Seat Belts

Including retractable belts, high visibility safety orange and standard color belts in a variety of lengths and styles

### First Aid Kits

Including those for minor injuries and high risk work zones

See Safety Equipment Section







### Control Box Assembly SJ3B OEM

**Part Number**  
SJ130028

⚠️ **WARNING:** Cancer and reproductive harm - [www.P65Warnings.ca.gov](http://www.P65Warnings.ca.gov)



### Battery Charger 24VDC

**Part Number**  
SJ228476

⚠️ **WARNING:** Cancer and reproductive harm - [www.P65Warnings.ca.gov](http://www.P65Warnings.ca.gov)



### Joystick PWM Hydraulic Proport

**Part Number**  
SJ159108

⚠️ **WARNING:** Cancer and reproductive harm - [www.P65Warnings.ca.gov](http://www.P65Warnings.ca.gov)



SJ134573



SJ194615

### Motors

| Part Number | Description                      |
|-------------|----------------------------------|
| SJ134573    | Hydraulic Wheel Motor with Brake |
| SJ123476    | Motor/Pump .291 Combo 24V        |
| SJ194615    | Wheel Motor                      |

⚠️ **WARNING:** Cancer and reproductive harm - [www.P65Warnings.ca.gov](http://www.P65Warnings.ca.gov)



SJ162715BA

### Cylinders

| Part Number | Description                         |
|-------------|-------------------------------------|
| SJ162715BA  | Cylinder Assembly SJIII 32xx to 48x |
| SJ121087BA  | Black Steer Cylinder 3015/3219      |

⚠️ **WARNING:** Cancer and reproductive harm - [www.P65Warnings.ca.gov](http://www.P65Warnings.ca.gov)



SJ108020



SJ108022



SJ125785



SJ108876

### Wheel and Tire

| Part Number | Description                   |
|-------------|-------------------------------|
| SJ108020    | White Tire 3015               |
| SJ108022    | White Tire With Brake 3015    |
| SJ125785    | Non-Marking Wheel 16 x 5 x 12 |
| SJ108876    | Non-Marking Tire Assembly ITL |

⚠️ **WARNING:** Cancer and reproductive harm - [www.P65Warnings.ca.gov](http://www.P65Warnings.ca.gov)



### Ladder 3 Step EQ. SP. SJ3B

**Part Number**  
SJ122307

⚠️ **WARNING:** Cancer and reproductive harm - [www.P65Warnings.ca.gov](http://www.P65Warnings.ca.gov)



SJ107269

### Valves

| Part Number | Description                    |
|-------------|--------------------------------|
| SJ107269    | Valve SOL.CART.POPP.NC with MO |
| SJ128798    | Directional Valve, 24V DO3 wi  |

⚠️ **WARNING:** Cancer and reproductive harm - [www.P65Warnings.ca.gov](http://www.P65Warnings.ca.gov)



### Contactor, SPNO

**Part Number**  
SJ103101

⚠️ **WARNING:** Cancer and reproductive harm - [www.P65Warnings.ca.gov](http://www.P65Warnings.ca.gov)



### Filter Housing

**Part Number**  
SJ109568

⚠️ **WARNING:** Cancer and reproductive harm - [www.P65Warnings.ca.gov](http://www.P65Warnings.ca.gov)



### Limit Switch Pot Hole

**Part Number**  
SJ119348

⚠️ **WARNING:** Cancer and reproductive harm - [www.P65Warnings.ca.gov](http://www.P65Warnings.ca.gov)



### SJ3B Lift Cylinder Seal Kit

**Part Number**  
SJ121097

⚠️ **WARNING:** Cancer and reproductive harm - [www.P65Warnings.ca.gov](http://www.P65Warnings.ca.gov)



### 15 AMP Circuit Breaker

**Part Number**  
SJ117325

⚠️ **WARNING:** Cancer and reproductive harm - [www.P65Warnings.ca.gov](http://www.P65Warnings.ca.gov)

# Skyjack OEM Parts

WAREHOUSE



## Element Oil Filter

Part Number  
SJ104254

⚠️WARNING: Cancer and reproductive harm - [www.P65Warnings.ca.gov](http://www.P65Warnings.ca.gov)



## Carbon Brush

Part Number  
SJ109174

⚠️WARNING: Cancer and reproductive harm - [www.P65Warnings.ca.gov](http://www.P65Warnings.ca.gov)



## 6 Foot Cable Protection

Part Number  
SJ104127

⚠️WARNING: Cancer and reproductive harm - [www.P65Warnings.ca.gov](http://www.P65Warnings.ca.gov)



## Hose SJM Drive Short 90

Part Number  
SJ107732

⚠️WARNING: Cancer and reproductive harm - [www.P65Warnings.ca.gov](http://www.P65Warnings.ca.gov)



## Key Switch 2 POS Head

Part Number  
SJ102754

⚠️WARNING: Cancer and reproductive harm - [www.P65Warnings.ca.gov](http://www.P65Warnings.ca.gov)



SJ100509



SJ216212

## Quick Release Pins

| Part Number | Description |
|-------------|-------------|
| SJ100509    | —           |
| SJ216212    | Assembly    |

⚠️WARNING: Cancer and reproductive harm - [www.P65Warnings.ca.gov](http://www.P65Warnings.ca.gov)



## Scissor Bumper

Part Number  
SJ100700

⚠️WARNING: Cancer and reproductive harm - [www.P65Warnings.ca.gov](http://www.P65Warnings.ca.gov)



## Dark Grey Spray Paint

Part Number  
SJ108384DG

⚠️WARNING: Cancer and reproductive harm - [www.P65Warnings.ca.gov](http://www.P65Warnings.ca.gov)



## Stanley Spring Hinge

Part Number  
SJ117277

⚠️WARNING: Cancer and reproductive harm - [www.P65Warnings.ca.gov](http://www.P65Warnings.ca.gov)



## Wheel Bolt 1/2 x 1 1/16

Part Number  
SJ103199

⚠️WARNING: Cancer and reproductive harm - [www.P65Warnings.ca.gov](http://www.P65Warnings.ca.gov)

## Section 4

# Electric Truck Components

### Contents

|  |                      |
|--|----------------------|
| Replacement Bulbs                            | 4.02                 |
| Lights                                       | 4.03                 |
| Warning Devices                              | 4.06                 |
| Deutsch Connectors                           | 4.11                 |
| GE Plug Kits                                 | 4.11                 |
| Grounding Straps                             | 4.12                 |
| Switches                                     | 4.12                 |
| Lift Truck Power Switch Keys                 | 4.18                 |
| Wire and Cable                               | 4.19                 |
| Fuses  | 4.20                 |
| Contactors/Contactor Tips                    | 4.24                 |
| Cards  | 4.27                 |
| DC/DC Converters                             | 4.29                 |
| Solenoids                                    | 4.30                 |
| Battery Capacity Indicators<br>& Hour Meters | 4.31                 |
| Yale, Hyster, Raymond<br>Parts Breakdown     | 4.33-4.35, 4.48-4.49 |
| Lift Structure                               | 4.36                 |
| Drive Unit, Brake, and Steering              | 4.50                 |
| Motor and Hydraulic                          | 4.57                 |
| Cylinders/Seal Kits                          | 4.69                 |
| Miscellaneous                                | 4.70                 |

#### New Items:

LED Work Light - p. 4.03  
Halogen Spot Lights - p. 4.05  
Horn, Mini - p. 4.10  
Fork Riser - p. 4.36  
Drive Wheel - Rubber - p. 4.53  
Electric Brake - p. 4.56  
Horn Plunger - p. 4.70  
Horn Springs - p. 4.71  
Hose Clamp - p. 4.75  
Center Cylinder Pulley - p. 4.75  
Speed Sensor - p. 4.75

Note: 1910.178(q)(5) (1998) of the Occupational Safety and Health Act (OSHA) requires that "All parts of any such industrial truck requiring replacement shall be replaced only by parts equivalent as to safety with those used in the original design."



# Replacement Bulbs

| Part Number                    | Voltage | Number of Elements | Number of Contacts | Bulb Part Number | Series                       |
|--------------------------------|---------|--------------------|--------------------|------------------|------------------------------|
| <b>Single and Dual Element</b> |         |                    |                    |                  |                              |
| 110578                         | 12      | 1                  | 1                  | 93               | Stockpickers                 |
| 116364                         | 12      | 1                  | 1                  | 1141             | RR/RD3, RR/RD5               |
| 110581                         | 12      | 1                  | 1                  | 1156             | Stockpickers, FC/FP, TSEV100 |
| H49784-573                     | 12      | 1                  | 1                  | 1156, LED        | Stockpickers, FC/FP, TSEV100 |
| 122232                         | 12.8    | 1                  | 2                  | 1142             | FC                           |
| 112480                         | 12.8    | 1                  | 2                  | 1157             | FC                           |
| 101365                         | 28      | 1                  | 1                  | 1683             | TSEV100                      |
| 083307                         | 24      | 1                  | 1                  | 3011             | SP36, SP42, SP48, TS         |
| 078533-001                     | 28      | 1                  | 2                  | 1638             | Stockpickers, FC/FP, PE4     |
| 118321                         | 38      | 1                  | 1                  | SP7              | FC/FP                        |
| 370746                         | 36      | 1                  | 2                  |                  |                              |
| 370338                         | 36      | 2                  | 2                  | 3036-25          |                              |
| 117993                         | 38      | 1                  | 2                  | SP1              | FC/FP, FC4, SC4              |
| 101957                         | 38      | 2                  | 2                  | SP5              | Turrets, RC, SC              |
| 118322                         | 50      | 1                  | 1                  | SP8              | FC/FP, RC3                   |
| 117994                         | 50      | 1                  | 2                  | SP2              | FC, FC4                      |
| 105491                         | 50      | 1                  | 2                  | SP6              | TSP                          |

| Part Number           | Vdc   | Current | Watts |
|-----------------------|-------|---------|-------|
| <b>LED Bipolar DC</b> |       |         |       |
| 370655                | 12-14 | 0.03    | 0.45  |

| Part Number                  | Voltage | Bulb Part Number | Series  |
|------------------------------|---------|------------------|---|
| <b>Small with Short Base</b> |         |                  |   |
| 086042-001                   | 14      | 386              | RR, RD, RS, RR and RD Heated Cab, TS                                  |
| 087227                       | 24      | 1819             | PC, PE, PR, PW, RC, RR/RD/RS, RC, SC, SP36, SP42, SP48, W(HD), WB, WR |

| Part Number                      | Voltage | Diameter | Series   |
|----------------------------------|---------|----------|--|
| <b>Sealed Beam (102 mm/4 in)</b> |         |          |  |
| 340002-001                       | 12      | 4411     |  |
| 346957                           | 12-24   |          | LED sealed beam is a direct replacement for part numbers 340002-001 & 087195-001                 |
| 146957                           | 10-60   |          | LED sealed beam is a direct replacement for part numbers 340002-001, 087195-001, 102195 & 105619 |
| 087195-001                       | 28      | 4589     | Reach Trucks, Stockpickers   |
| 102195                           | 36      | 4350     | Reach Trucks, Turrets, FC 4000, RC, RC 3000, SC, SC 4000   |
| 105619                           | 48      | 4340     | TSP  |

|                             |    |      |                       |
|-----------------------------|----|------|-----------------------|
| <b>Small with Long Base</b> |    |      |                       |
| 105816                      | 36 | 1822 | TSP, TSEV100, SP 3000 |

|                                |    |       |    |
|--------------------------------|----|-------|----|
| <b>Long with Dual Contacts</b> |    |       |    |
| 111382                         | 12 | 211-2 | FC |

|                                 |       |      |         |
|---------------------------------|-------|------|---------|
| <b>Xenon Flashtube - Strobe</b> |       |      |         |
| 340009                          | 12-80 | 5001 | RR 5000 |

|                                |      |     |                         |
|--------------------------------|------|-----|-------------------------|
| <b>Bulb with Plug, Halogen</b> |      |     |                         |
| 125672                         | 12.8 | 862 | FC/FP, FC 4000, PE 4000 |

|                           |  |         |          |
|---------------------------|--|---------|----------|
| <b>Flashtube - Strobe</b> |  |         |          |
| 111782                    |  | 400-537 | TSP 6000 |

| Bulb with Wire | Specs | Series  | Wattage | Warranty |
|----------------|-------|---------|---------|----------|
| 340108         | 10-30 | H-3 LED |         | 3 years  |
| 112481         | 12.8  | H-3     | 55      |          |
| 380030-160     | 12    | H-3     | 55      |          |
| 796059-005     | 24    | H-3     | 70      |          |
| 340080         | 36    | H-3     | 35      |          |
| 340075         | 48    | H-3     | 55      |          |

|                         |    |                        |
|-------------------------|----|------------------------|
| <b>Fluorescent Bulb</b> |    |                        |
| 370576                  | 58 | 9" Length; Wattage: 18 |

|                       |  |
|-----------------------|--|
| <b>Base with Bulb</b> |  |
| 370744                | Used on Caterpillar, Clark, Hyster, Mitsubishi, Yale oval work light |

⚠️ **WARNING:** Cancer and reproductive harm - [www.P65Warnings.ca.gov](http://www.P65Warnings.ca.gov)



**Work Lights**

| Part Number | Description     | Voltage | Series           | Replacement Bulb   | Lens    |
|-------------|-----------------|---------|------------------|--|---------|
| 107712      | Front Work      | 12      | FC/FP            | 112481 (12.8 volt)                                       | Plastic |
| 118129*     | Front Work      |         | FC/FP, RC 3000   | 110581 (12 volt)<br>118321 (38 volt)<br>118322 (50 volt) | Plastic |
| 125674      | Front Work      | 12      | FC/FP            | 125672 (12.8 volt)                                       | Plastic |
| 128653      | Front/Rear Work | 12      | FC 4000, PE 4000 | 125672 (12.8 volt)                                       | Plastic |
| 145981      | Front Work      | 12      | C5               | 125672 (12.8 volt)                                       | Plastic |

◀ 125674 Accessories

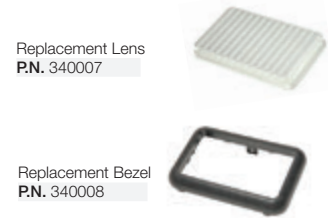

Note: 1-year warranty. \*Bulb not included.



**LED Work Lights**

| Part Number | Description             | Voltage | Lens    |
|-------------|-------------------------|---------|---------|
| 340023-001  | Bottom/Horizontal Mount | 12-48   | Plastic |
| 340023-002  | Side/Vertical Mount     | 12-48   | Plastic |

Note: 2-year warranty. Replacement Part: Wire assembly for all LED work lights is 340053. Additional Note: FC 4000 Series trucks require Mounting Bracket P.N. 145887.

⚠ WARNING: Cancer and reproductive harm - [www.P65Warnings.ca.gov](http://www.P65Warnings.ca.gov)



**LED Work Light**

| Part Number | Description   | Voltage | Lens    |
|-------------|---|---------|---------|
| 152949-001  | Bottom/Vertical Mount - No harness, has deutsch connector. Flood lens. 2-year warranty. | 12-48   | Plastic |

⚠ WARNING: Cancer and reproductive harm - [www.P65Warnings.ca.gov](http://www.P65Warnings.ca.gov)



**LED Work Light with Turn Signal**

| Part Number | Description   | Voltage | Lens    |
|-------------|---|---------|---------|
| 152949-002  | Bottom/Vertical Mount - White LEDs for visibility & amber for turn signal functionality. Flood lens. 2-year warranty. | 12-48   | Plastic |

⚠ WARNING: Cancer and reproductive harm - [www.P65Warnings.ca.gov](http://www.P65Warnings.ca.gov)



**LED Work Light**

| Part Number | Description  | Voltage | Lens          | Mounting Hardware Included |
|-------------|--|---------|---------------|----------------------------|
| 360093      | Bottom/Horizontal Mount. Only for C5 & CG trucks. 3-year warranty. | 12-48   | Glass         |                            |
| 161763-001  | <b>NEW!</b>  | 12-48   | Polycarbonate | X                          |
| 161763-002  |  | 12-48   | Polycarbonate | --                         |



**Work Light**

Part Number - 380030-324

- RH
- 12V
- 55 Watt
- Halogen

▼ OEM Reference

|    |             |    |             |    |           |
|----|-------------|----|-------------|----|-----------|
| CT | A0000-29523 | HY | 8541835     | YT | 580082533 |
| HY | 2064837     | MB | A0000-29523 | YT | 580083835 |
| HY | 2098084     | YT | 580044915   | YT | 580083836 |
| HY | 8523117     | YT | 580053962   |    |           |



**Work Light**

Part Number - 370751

- LH
- 12V
- 55 Watt
- Halogen

▼ OEM Reference

|    |             |    |             |    |           |
|----|-------------|----|-------------|----|-----------|
| CT | A0000-29524 | MB | A0000-29524 | YT | 580082534 |
| HY | 2064838     | YT | 580044916   | YT | 580083837 |
| HY | 2098085     | YT | 580053963   |    |           |



**LED Head Lamp - 12-80V**

Part Number - 380030-184

Note: 1-year warranty.

- 18W LED power
- Lumens 1300
- Die-cast aluminum housing
- Waterproof rate IP67

Uses L-Bracket  
P.N. 380030-251



▼ OEM Reference  
HM 805



**LED Head Lamp - 12-80V**

Part Number - 380030-185

Uses L-Bracket  
P.N. 380030-251

- 27W LED power
- Lumens 1755
- Die-cast aluminum housing
- 4.33" H x 4.33" W x 1.77" D
- Waterproof rate IP67

Note: 1-year warranty.



▼ OEM Reference  
HM 818

**Head Lamp - 12V**

Part Number - 380030-281

▼ OEM Reference  
TY 56510-40580-71



**Head Lamp - 12V**

Part Number - 380102-212

Note: 1-year warranty.

▼ OEM Reference  
TY 56510-U2230-71



**Head Lamp - 36V**

Part Number - 380030-161

▼ OEM Reference

HY 1340842 YT 518796691  
HY 2304780 YT 520064601  
TY 56510-13300-71

Note: 1-year warranty.



**Head Lamp - 12V**

Part Number - 380030-130

▼ OEM Reference

AC 3EB-55-F1851 KO 8772544  
AC 8766308 KO 3EB-55-A5560  
AC 8772544 LP 350-4579  
AC 3EB-55-A5560 KO 8766308  
KO 3EB-55-F1851 KO 8772544  
KO 8766308



Note: 1-year warranty.

**Head Lamp - 12V**

Part Number - 380030-125

■ Uses H-3 halogen bulb

Note: 1-year warranty.

Replacement bulb: P.N. 380030-160

▼ OEM Reference

CL 26010-FE300 TC 216G2-40602  
CT 05101-05400  
NI 26010-FE300



**Front Lamp - 12V - 2 pin**

Part Number - 380030-005

▼ OEM Reference

AC 4949757 HAM 37B-1EH-2010A  
HAM 4949757 HAM 37B-1EH-2010L  
HAM 37B-1EA-2010 KM 4949757  
HAM 37B-1EH-2010 KO 37B-1EH-2010

Note: 1-year warranty.



**Lamp Assembly - 36V**

Part Number - 370499

▼ OEM Reference

CL 448422 MB a0000-30163  
CT a0000-30163 TY 56510-12240-71



**Spot Lights**

| Part Number | Description | Voltage | Series  | Replacement Bulb | Lens  | Mounting Hardware Included |
|-------------|-------------|---------|---|------------------|-------|----------------------------|
| 104296-001  | Front/Rear  | 48      | TSP   | 105619           | Glass | x                          |
| 104296-002  | Front/Rear  | 36      | RC, RC 3000, SC, SC 4000, Reach, TSev100, TSP | 102195           | Glass | x                          |
| 104296S103  | Front/Rear  | 24      | Reach, SP                                     | 087195-001       | Glass | x                          |
| 104296-004  | Spot Light  | 36      | RC, RC3, SC, SC4, Reach, TSev100, TSP         | 102195           | Glass |                            |
| 104296-005  | Spot Light  | 24      | Reach, SP                                     | 087195-001       | Glass |                            |



104296-XXX

Note: 1-year warranty.

▲WARNING: Cancer and reproductive harm - [www.P65Warnings.ca.gov](http://www.P65Warnings.ca.gov)

**LED Spot Lights**

| Part Number  | Description    | Voltage        | Series | Replacement Bulb   | Lens    | Mounting Hardware Included |
|--------------|----------------|----------------|--------|--------------------|---------|----------------------------|
| 146958S      | LED Spot light | 12-48<br>12-24 |        | 146957 ▲<br>346957 | Plastic |                            |
| 145982-001 ▲ | LED Spot light | 12-48<br>12-24 |        | 146957 ▲<br>346957 | Plastic | x                          |



145982-001 (LED)

- Polycarbonate lens, can be used in food applications
- Last for life of the truck
- Lower cost of ownership than sealed beams
- Energy savings

- Bright light, more visibility
- One light, multiple voltages
- Complies with: Buy America Standards, IEC IP69K, SAE J1455, UL Recognized

**LED Spot Light Replacement Bulbs:**  
P.N. 146957 (2-year warranty) ▲  
P.N. 346957 (2-year warranty)

▲WARNING: Cancer and reproductive harm - [www.P65Warnings.ca.gov](http://www.P65Warnings.ca.gov)

## Work/Spot Lights



### Halogen Spot Lights

| Part Number | Description        | Voltage | Series | Replacement Bulb | Lens  | Mounting Hardware Included |
|-------------|--------------------|---------|--------|------------------|-------|----------------------------|
| 161764-001  | Halogen Spot Light | 24      | SP     | 162095-001       | Glass | x                          |
| 161764-002  | Halogen Spot Light | 36      | SP     | 162095-002       | Glass | x                          |
| 161764-003  | Halogen Spot Light | 48      |        | 162095-003       | Glass | x                          |
| 161764-004  | Halogen Spot Light | 24      |        | 162095-001       | Glass | --                         |
| 161764-005  | Halogen Spot Light | 36      | RC5500 | 162095-002       | Glass | --                         |



## Dome Lights



| Part Number | Voltage | Series              | Replacement Bulb |
|-------------|---------|---------------------|------------------|
| 109810S     | 12      | SP 3000, FC, TS, SP | 110581           |

⚠ **WARNING:** Cancer and reproductive harm - [www.P65Warnings.ca.gov](http://www.P65Warnings.ca.gov)



| Part Number | V/C.P. | Series  | Replacement Bulb |
|-------------|--------|---------|------------------|
| 109811      | 12/15  | SP 3000 | 110578           |
| 116319      | 12/21  | RR 3000 | 116364           |

V/C.P. = Voltage/Candle Power

**Note:** 1-year warranty.

⚠ **WARNING:** Cancer - [www.P65Warnings.ca.gov](http://www.P65Warnings.ca.gov)

## Tail Lights



117998



380030-039



380030-076



158270-xxx



380030-077

| Part Number       | Series          | Voltage | Replacement Bulb | Warranty |
|-------------------|-----------------|---------|------------------|----------|
| <b>Bulb Light</b> |                 |         |                  |          |
| 117998            | FC/FP           | 48      | 117994           | 1-year   |
| 117998            | FC/FP           | 36      | 117993 ⚠         | 1-year   |
| 380030-039        | KM 8761802      | 12      |                  | 1-year   |
|                   | KO 37B-1EB-3010 | 12      |                  | 1-year   |
| 380030-076        | KO 3EB-55-A6660 | 12      |                  | 1-year   |
| <b>LED Light</b>  |                 |         |                  |          |
| 158270-001        | ⚠               | 12      | 2-YEAR WARRANTY  | 2-year   |
| 158270-002        | ⚠               | 24-36   |                  | 2-year   |
| 158270-003        | ⚠               | 48      |                  | 2-year   |
| 380030-077        | KO 3EB-55-A7720 | 12      |                  | 1-year   |

\*LED not replaceable.

⚠ **WARNING:** Cancer and reproductive harm - [www.P65Warnings.ca.gov](http://www.P65Warnings.ca.gov)

### ◀ Bulb Light Accessories

#### Replacement Lens

| Part Number | Color       | Used On    |
|-------------|-------------|------------|
| 120717 ⚠    | Small Red   | 117998     |
| 120718      | Red Center  | 117998     |
| 120719      | Small Clear | 117998     |
| 380030-043  | One Piece   | 380030-039 |



380030-043

⚠ **WARNING:** Cancer and reproductive harm - [www.P65Warnings.ca.gov](http://www.P65Warnings.ca.gov)

### ◀ 340014-XXX Wiring Instructions

| Wire Color | Function |
|------------|----------|
| White      | Backup   |
| White/Red  | Tail     |
| Red        | Brake    |
| Yellow     | Turn     |
| Black      | Ground   |

### Rear Lamp - 36V

Part No. - 380030-131

▼ OEM Reference  
NI 26550-GA30A



**Note:** 1-year warranty.

### Rear Lamp - 12V

Part No. - 380030-193

▼ OEM Reference  
NI 26550-FK100



**Note:** 1-year warranty.

### Rear Lamp - 12V (LED)

Part No. - 380030-198

▼ OEM Reference  
HY 2056824  
YT 580037207

**Note:** 1-year warranty.



**LED Strobe Lights**



**Flat Mount Base**

| Part Number | Color | Assembly Height (in) | Mounting Hole to Mounting Hole (in) | Voltage |
|-------------|-------|----------------------|-------------------------------------|---------|
| 159792-004  | Amber | 4.9                  | 2.80                                | 12-80   |
| 159792-005  | Red   | 4.9                  | 2.80                                | 12-80   |
| 159792-006  | Blue  | 4.9                  | 2.80                                | 12-80   |
| 340144      | Green | 4.9                  | 2.80                                | 12-80   |

Note: 2-year warranty.



**Conduit Mount Base**

| Part Number | Color | Assembly Height (in) | Diameter (in) | Voltage |
|-------------|-------|----------------------|---------------|---------|
| 159792-001  | Amber | 5.8                  | 2.8           | 12-80   |
| 159792-002  | Red   | 5.8                  | 2.8           | 12-80   |
| 159792-003  | Blue  | 5.8                  | 2.8           | 12-80   |

Note: 2-year warranty.



**Strobe Lights**



**Flat Mount Base - Low Profile**

| Part Number | Color | Assembly Height (in) | Mounting Hole to Mounting Hole (in) | Voltage |
|-------------|-------|----------------------|-------------------------------------|---------|
| 133186-003  | Blue  | 4.48                 | 4.382                               | 12-80   |
| 133186-004  | Red   | 4.48                 | 4.382                               | 12-80   |

Note: 1-year warranty.

⚠WARNING: Cancer and reproductive harm - [www.P65Warnings.ca.gov](http://www.P65Warnings.ca.gov)



**Flat Mount Base**

| Part Number | Color | Assembly Height (in) | Mounting Hole to Mounting Hole (in) | Voltage |
|-------------|-------|----------------------|-------------------------------------|---------|
| 127651-001  | Amber | 5.25                 | 3.40                                | 12-80   |
| 127651-002  | Red   | 5.25                 | 3.40                                | 12-80   |
| 127651-003  | Blue  | 5.25                 | 3.40                                | 12-80   |

Note: 1-year warranty.

**Kits (Flat Mount Base Only)**

| Part Number | Color | Voltage | Series                         |
|-------------|-------|---------|--------------------------------|
| 127509-001  | Amber | 12-80   | SC 4000 Series, FC 4000 Series |
| 127509-002  | Red   | 12-80   | SC 4000 Series, FC 4000 Series |
| 127509-003  | Blue  | 12-80   | SC 4000 Series, FC 4000 Series |

Note: Kits include weldment cover and lens blackout.



**Strobe Lamp**

| Part Number | Color | Height (in) | Width (in) | Diameter (in.) | Voltage |
|-------------|-------|-------------|------------|----------------|---------|
| 380030-108  | Amber | 2.75        | 2.25       | 5.5            | 12-110  |

Note: 1-year warranty.

Replacement Flash Tube: P.N. 380101-907

- ▼ OEM Reference
- CL 2366970
- HM 72268A
- HY 800049142
- TY 00591-08516-81



**Lamp Assembly**

| Part Number | Color | Height (in) | Width (in) | Diameter (in.) | Voltage |
|-------------|-------|-------------|------------|----------------|---------|
| 380030-237  | Amber | 1.25        | 1.75       | 1.75           | 12      |

- ▼ OEM Reference
- HY 2029548
- NI 26130-FE300
- YT 924737400

◀ **159792-XXX Accessories**

**Accessory Guard**

| Part Number |
|-------------|
| 118898      |



**Blackout Lens**

| Part Number |
|-------------|
| 161171      |

**Replacement Lens**

| Part Number | Color |
|-------------|-------|
| 161170-001  | Amber |
| 161170-002  | Blue  |
| 161170-003  | Red   |



▶ **138445-XXX Accessories**

**Replacement Lens**

| Part Number | Color |
|-------------|-------|
| 340024-001  | Amber |
| 340024-002  | Red   |
| 340024-003  | Blue  |



⚠WARNING: Cancer and reproductive harm - [www.P65Warnings.ca.gov](http://www.P65Warnings.ca.gov)

▶ **133186-XXX Accessories**

◀ **Replacement Lens**

| Part Number | Color |
|-------------|-------|
| 137195-001  | Red   |
| 137195-002  | Amber |
| 137195-003  | Blue  |
| 137195-004  | Green |

**Replacement Bulb**

| Part Number |
|-------------|
| 111782      |

⚠WARNING: Cancer and reproductive harm - [www.P65Warnings.ca.gov](http://www.P65Warnings.ca.gov)

◀ **127651-XXX / 112951-XXX Accessories**

**Replacement Lens**

| Part Number | Color |
|-------------|-------|
| 113611      | Amber |
| 113612      | Blue  |
| 113613      | Red   |



**Replacement Bulb**

| Part Number |
|-------------|
| 340009      |



**Accessory Guard**

| Part Number |
|-------------|
| 118898      |



**Blackout Lens**

| Part Number |
|-------------|
| 113620      |



Flashing Lights



Low Profile - Two Wire Filter

| Part Number | Color | Assembly Height (in) | Width (in) | Voltage | Series               |
|-------------|-------|----------------------|------------|---------|----------------------|
| 161421-001  | Amber | 4.48                 | 4.38       | 12-48   | TSP 6000/7000 Series |

Note: 1-year warranty.



Low Profile - LED Flashing Light

| Part Number | Color | Assembly Height (in) | Width (in) | Voltage | Series               |
|-------------|-------|----------------------|------------|---------|----------------------|
| 133186-005  | Amber | 4.50                 | 4.38       | 12-110  | TSP 6000/7000 Series |
| 161421-003  | Blue  | 4.50                 | 4.38       | 12-110  | TSP 6000/7000 Series |
| 133186-007  | Green | 4.50                 | 4.38       | 12-110  | TSP 6000/7000 Series |
| 161421-002  | Red   | 4.50                 | 4.38       | 12-110  | TSP 6000/7000 Series |

Note: 2-year warranty.

⚠️WARNING: Cancer and reproductive harm - [www.P65Warnings.ca.gov](http://www.P65Warnings.ca.gov)



◀ 161421-001 Accessories

Replacement Lens

| Part Number | Color |
|-------------|-------|
| 137195-001  | Red   |
| 137195-002  | Amber |
| 137195-003  | Blue  |
| 137195-004  | Green |

Replacement Bulb

| Part Number |
|-------------|
| 110581      |

⚠️WARNING: Cancer and reproductive harm - [www.P65Warnings.ca.gov](http://www.P65Warnings.ca.gov)

Kits

| Part Number | Voltage | Series                    |
|-------------|---------|---------------------------|
| 101475-001  | 24      | SP42                      |
| 162496-002  | 24      | SP36, SP48                |
| 162496-001  | 24      | SP36, SP42, SP48, TSev100 |

Note: 1-year warranty.



101475-001



162496-002



162496-001

Spot Lights

**Blue or Red LED Spot Lights**

P.N. 160173 - Blue  
P.N. 160173-002 - Red

- 12-48V; plastic
- 65 Lumens (160173)
- 111 Lumens (160173-002)
- Polycarbonate lens, can be used in food applications
- Spot beam pattern
- Universal mount
- Does not include wiring; connector needed is 320060 & (2) contacts part number 320061



160173



160173-002



**Note:** 3-year warranty

▲WARNING: Cancer and reproductive harm - [www.P65Warnings.ca.gov](http://www.P65Warnings.ca.gov)

**Blue or Red LED Work Zone Light**

P.N. 340106 - Blue  
P.N. 161386 - Red

- 12-64V
- Mount to sides of forklift overhead guard; requires two lights (one per side)
- Light Source: 3W LED
- Lumens: 1200 LM; Output: 18W
- Aluminum housing; plastic lens; hardware included
- IP67, CE



**Note:** 2-year warranty



**Arrow, LED Blue or Red Spot Light**

P.N. 340093-002 - Blue  
P.N. 340093-003 - Red

- 12-60V, 0.6 amps
- Blue arrow light provides warning for pedestrians
- Polycarbonate lens, can be used in food applications
- Aluminum housing
- Universal mount



**Note:** 3-year warranty



**Blue LED Spot Light**

P.N. 340093

- 12-80V
- 200 Lumens
- Polycarbonate lens, can be used in food applications
- Spot beam pattern
- Wire connector
- Universal mount
- UL Certified



**Note:** 3-year warranty



**Blue/Red Light Kits**

| Truck Models               | Power Unit 1st                       |                              |  |   | Forks 1st                            |                              |  |   |
|----------------------------|--------------------------------------|------------------------------|--|---|--------------------------------------|------------------------------|--|---|
|                            | Premium Blue LED Spot Light (160173) | Blue LED Spot Light (340093) | Arrow Blue LED Spot Light (340093-002) | Premium Red LED Spot Light (160173-002) | Premium Blue LED Spot Light (160173) | Blue LED Spot Light (340093) | Arrow Blue LED Spot Light (340093-002) | Premium Red LED Spot Light (160173-002) |
| RC5500                     | 340200                               | 340200-001                   | 340200-003                             | 340200-002                              | -                                    | -                            | -                                      | -                                       |
| RR 5200/ 5200AC & RR5700   | 340202                               | 340202-001                   | 340202-003                             | 340202-002                              | 340202                               | 340202-001                   | 340202-003                             | 340202-002                              |
| C5 Cushion                 | 340201                               | 340201-001                   | 340201-003                             | 340201-002                              | 340203                               | 340203-001                   | 340203-003                             | 340203-002                              |
| FC4000/4500 & FC5200       | 340203                               | 340203-001                   | 340203-003                             | 340203-002                              | 340203                               | 340203-001                   | 340203-003                             | 340203-002                              |
| SC4000/4500 & SC5200       | 340203                               | 340203-001                   | 340203-003                             | 340203-002                              | 340203                               | 340203-001                   | 340203-003                             | 340203-002                              |
| SP3200/3400/ 3470 & SP3500 | 340205                               | 340205-001                   | 340205-003                             | 340205-002                              | -                                    | -                            | -                                      | -                                       |
| TSP6000/6500 & TSP7000     | 340206                               | 340206-001                   | 340206-003                             | 340206-002                              | -                                    | -                            | -                                      | -                                       |
| RM/RMD 6000                | 340210                               | 340210-001                   | 340210-003                             | 340210-002                              | 340211                               | 340211-001                   | 340211-003                             | 340211-002                              |
| PE4000 & PE4500            | 340207                               | 340207-001                   | 340207-003                             | 340207-002                              | 340207                               | 340207-001                   | 340207-003                             | 340207-002                              |
| Both Directions            | 340208                               | 340208-001                   | 340208-003                             | 340208-002                              | -                                    | -                            | -                                      | -                                       |
| Additional Light           | 340209                               | 340209-001                   | 340209-003                             | 340209-002                              | -                                    | -                            | -                                      | -                                       |

Complete model-specific kits include spot light and all necessary mounting hardware for a professional fit.

▲WARNING: Cancer and reproductive harm - [www.P65Warnings.ca.gov](http://www.P65Warnings.ca.gov)

Horns



**Electronic Horn with Straight Bracket**

| Part Number | Voltage    | Life Cycles | Decibels (minimum) |
|-------------|------------|-------------|--------------------|
| 332198      | 24, 36, 48 | 500,000     | 105 dB             |
| 332199      | 12, 24     | 1,000,000   | 105 dB             |



Part Number - 370347

**Horn (24 Volt) - Electronic H-Tone**

Decibels (minimum): 105 dB  
3 Terminals

▼ OEM Reference  
RA 590-643-104



Part Number - 360038-276

**Electronic Horn with Straight Bracket (24, 36, 48 Volt)**

Decibels (minimum): 112 dB  
3 Terminals



**Mechanical Horns**

| Part Number | Voltage | Life Cycles | Decibels (minimum) |
|-------------|---------|-------------|--------------------|
| 078708-011  | 12      | 60,000      | 108 dB             |
| 078708-002  | 24      | 60,000      | 108 dB             |



**Electronic Horn with "L" Bracket**

2 Terminals

| Part Number | Voltage    | Life Cycles | Decibels (minimum) |
|-------------|------------|-------------|--------------------|
| 159162      | 24, 36, 48 | 500,000     | 105 dB             |
| 147631-003  | 24, 36, 48 | 500,000     | 105 dB             |

159162



147631-003



Part Number - 380030-200

**Horn (12 Volt)**

▼ OEM Reference  
NI 25620-GH10A



Part Number - 380030-113

**Horn (12 Volt)**

Decibels (minimum): 100 dB  
2 Terminals

▼ OEM Reference  
KO 3EB-55-23511



Part Number - 143503

**Electronic Horn with "L" Bracket (12 Volt)**

Decibels (minimum): 105 dB

**Note:** Kit includes: horn, L-bracket, harness and kit instructions.



Part Number - 370748

**Electronic Horn (12 Volt)**

105-118 dB

▼ OEM Reference

|            |              |              |
|------------|--------------|--------------|
| HY 152764  | HY 4005218   | YT 580036342 |
| HY 1618978 | YT 550005823 | YT 580068957 |



Part Number - 380700-024

**Horn (24 Volt)**

Decibels (minimum): 112 dB  
3 Terminals

▼ OEM Reference

|                    |                    |
|--------------------|--------------------|
| BT 590-460-101     | PM 590-629         |
| BT 590-629         | PM 590-640-001     |
| BT 590-640-001     | PM 590-640-101     |
| BT 590-640-101     | PM 590-642-001     |
| BT 590-642-001     | PM 590-643-001     |
| BT 590-643-001     | PM 590-643-001-ORG |
| BT 590-643-001-ORG | RA 590-460-101     |
| CT 1008767         | RA 590-629         |
| CT NA015879        | RA 590-640-001     |
| CT NA019240        | RA 590-640-101     |
| CT NA020529        | RA 590-642-001     |
| MB 1008767         | RA 590-643-001     |
| MB NA015879        | RA 590-643-001-ORG |
| MB NA019240        | TY 00590-42448-71  |
| MB NA020529        | TY 00590-43983-71  |
| PM 590-460-101     |                    |



Part Number - 398000-154

**Horn Assembly (12 Volt)**

▼ OEM Reference

TY 58120-26640-71

**Warning Devices**

**Horns**



**Part Number - 370667**  
**Horn Mini (12 Volt)**  
 ▼ OEM Reference  
 AC 3EB-55-41271  
 HY 2021957  
 KO 3EB-55-41271  
 KO 8778367  
 YT 919172400



**Suppressor**  

| Part Number | Description  |
|-------------|--|
| 077732      | For use with mechanical horns, 078708.   |
| 129579      | Suppressor only needed in certain applications with horn styles 159162 and 332198. |
| 159161      | Suppressor kit required for RC5500s built prior to December 2015                   |



**Part Number - 370766**  
**Horn (12 Volt)**  
 Decibels (minimum): 105 dB  
 ▼ OEM Reference  
 HY 1495185  
 YT 580023894

**Back-Up Alarms**



| Part Number | Voltage | Decibel Level | Type     |
|-------------|---------|---------------|----------|
| 149538      | 12-80   | 87            | Standard |
| 115565      | 12-48   | 97            | Standard |
| 126035      | 12-48   | 77-87-97      | Standard |
| 129615      | 12-48   | 77-97         | Smart    |
| 139068-001  | 12-24   | 82-102        | Smart    |

◀ **Accessories: Filter Block (P.N. 112533)**  
 for use with back-up alarms.



Filter Block Wiring Diagram



**Harnesses**  

| Part Number | Description            |
|-------------|------------------------|
| 126036      | Cord w/spade terminals |
| 154030      | Cord with Deutsch pins |

  
 To be used with the 126035 alarm ONLY



**Part Number - 360038-279**  
**Back-Up Alarm\Horn**  
 12-24V, 102 dB (minimum)  
 ▼ OEM Reference  

|               |                   |
|---------------|-------------------|
| CL 914772     | HY 0377875        |
| CL 6499931    | MB 215411         |
| CT 215411     | MB 914584         |
| CT 914584     | MB A000031698     |
| CT A000031698 | TY 00591-08099-81 |
| HY 1350735    | YT 220101215      |
| HY 0346495    | YT 505969500      |



**Part Number - 361038-279**  
**Back-Up Alarm**  
 12-24V, 97dB  
 ▼ OEM Reference  

|            |              |
|------------|--------------|
| HY 0206749 | YT 524143269 |
| HY 2042675 | YT 580045134 |
| HY 2064930 |              |



**Part Number - 370459**  
**Back-Up Alarm\Horn - Electronic**  
 107 dB, 24-48V,  
 M/F Spade Connector  
 ▼ OEM Reference  

|                |                |
|----------------|----------------|
| HY 1483422     | NI 25620-FS000 |
| BR 25620-FS000 | NI 25620-FS001 |
| BR 25620-FS001 |                |



**Part Number - 370750**  
**Back-Up Alarm**  
 12-24V, 82-102 dB (minimum)  
 ▼ OEM Reference  

|            |              |
|------------|--------------|
| HY 2064929 | YT 580045132 |
| HY 8522216 |              |

## Deutsch Connectors



### Deutsch DT Connector Kits

| Part No.   | No. of Circuits | Dust Cap   |
|------------|-----------------|------------|
| 130197-002 | 2               | 366002-002 |
| 130197-003 | 3               |            |
| 130197-004 | 4               |            |
| 130197-006 | 6               | 066002-004 |
| 130197-008 | 8               | 366002-008 |
| 130197-012 | 12              |            |

**Note:** Kits include receptacle, plug, contacts, seals, inserts, and instructions on how to use extraction tool and crimping tool. Used with 20-14 gauge wire.

**▲ Replacement Contacts**

| Part Number | Description    | Quantity |
|-------------|----------------|----------|
| 130197-015  | Pin, Nickel    | 25       |
| 130197-016  | Socket, Nickel | 25       |
| 130197-017  | Pin, Gold      | 25       |
| 130197-018  | Socket, Gold   | 25       |

**Note:** Used only on 130197-XXX.

**▲WARNING:** Cancer and reproductive harm - [www.P65Warnings.ca.gov](http://www.P65Warnings.ca.gov)



### Deutsch DTM Connector Kits

| Part Number | Number of Circuits |
|-------------|--------------------|
| 131237-002  | 2                  |
| 131237-003  | 3                  |
| 131237-004  | 4                  |
| 131237-006  | 6                  |
| 131237-008  | 8                  |
| 131237-012  | 12                 |

**Note:** Kits include receptacle, plug, contacts, seals, inserts, and instructions on how to use extraction tool and crimping tool. Used with 22-16 gauge wire.

**▲ Replacement Contacts**

| Part Number | Description    | Quantity |
|-------------|----------------|----------|
| 131237-015  | Pin, Nickel    | 25       |
| 131237-016  | Socket, Nickel | 25       |
| 131237-017  | Pin, Gold      | 25       |
| 131237-018  | Socket, Gold   | 25       |

**Note:** Used only on 131237-XXX.

**▲WARNING:** Cancer and reproductive harm - [www.P65Warnings.ca.gov](http://www.P65Warnings.ca.gov)



### Extraction Tool

**Part Number - 062706**

Used to remove Deutsch pin and socket contacts from DT and DTM connectors.



### Crimping Tool

**Part Number - 062737-002**

For stripping insulation and crimping new terminals on light gauge electrical wire for insertion into Deutsch DT and DTM connectors.

## GE Plug Kits

### Plug Kit (A)

P.N. 108934



### Plug Kit (Y)

P.N. 112528



### Plug Kit (B)

P.N. 108935



### Plug Kit (Z)

P.N. 108936



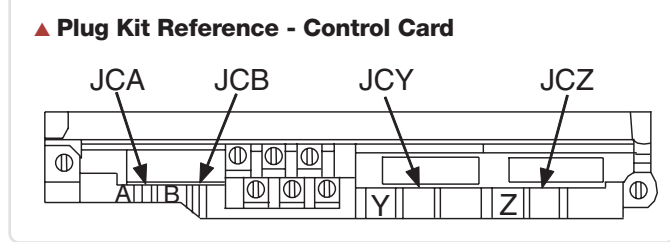

## Grounding Straps

### Part Number Length (in.)

|            |       |
|------------|-------|
| 102126-004 | 5.75  |
| 102126-003 | 8.50  |
| 102126-002 | 10.50 |
| 102126-005 | 12.50 |
| 102126-001 | 18.00 |

Resistivity 100 OHM-CM



Part Number - 370286

### Cable Assembly Drag

Overall length 11", cable length 10",  
3/8" diameter, terminal hole dia. 1/4"

▼ OEM Reference

|                    |                   |
|--------------------|-------------------|
| RA 154-009-116     | RA DS227245       |
| RA 154-009-116/001 | TY 00590-47108-71 |



## Switches - Rocker and Toggle

Part Number - 117268

Turtle / rabbit symbols  
Single pole / single throw

▼ OEM

|             |                   |              |
|-------------|-------------------|--------------|
| SW 2139     | TY 00591-45237-81 | YT 220015942 |
| LP 393-2604 |                   |              |



Part Number - 062595-005

On-none-on  
SPDT

▼ OEM

|              |              |
|--------------|--------------|
| HY 800130867 | TY 800130867 |
|--------------|--------------|

⚠ WARNING: Cancer - [www.P65Warnings.ca.gov](http://www.P65Warnings.ca.gov)



Part Number - 062595-001

On-off-on  
SPDT

▼ OEM

|              |                   |              |
|--------------|-------------------|--------------|
| HY 800018665 | SW 1792           | YT 220041952 |
| LP 393-9904  | TY 00591-73979-81 | YT 800018665 |

⚠ WARNING: Cancer - [www.P65Warnings.ca.gov](http://www.P65Warnings.ca.gov)



Part Number - 062595-007

On (momentary)-none-on  
SPST

⚠ WARNING: Cancer - [www.P65Warnings.ca.gov](http://www.P65Warnings.ca.gov)



Part Number - 062595-002

On-none-off  
SPST

▼ OEM

|              |                   |              |
|--------------|-------------------|--------------|
| SW 1793      | LP 393-9905       | YT 220042503 |
| HY 800018666 | TY 00591-73980-81 | YT 800018666 |

⚠ WARNING: Cancer - [www.P65Warnings.ca.gov](http://www.P65Warnings.ca.gov)



Part Number - 077633

Single pole / single throw  
6A @ 125vdc  
3A @ 250vdc

▼ OEM

|              |                   |              |
|--------------|-------------------|--------------|
| CL 7004240   | TO 215054         | YT 220014497 |
| HY 800076231 | TY 00591-41984-81 | YT 800076231 |
| SW 430       | TY 00591-60665-81 |              |



Part Number - 351096-347

Toggle Switch

▼ OEM

|            |                |                   |
|------------|----------------|-------------------|
| BK 709805  | LI 709805      | TY 00591-32323-81 |
| CL 1405848 | MB 0973020     | TY 00591-57413-81 |
| CL 314328  | RA 590-097     | TY 00591-70452-81 |
| CT 0973020 | RA 590-097-001 | TY 00591-70549-81 |
| DX 1405848 | RA 590-097-01  | YT 220002261      |
| HY 3018438 | RA 590-970-1   | YT 220010358      |
| HY 3026530 | RA DS227683    | YT 220016771      |
| HY 3039786 | SJ 102583      |                   |



Part Number - 062595-003

On (momentary)-off-on (momentary)  
SPDT

▼ OEM

|              |                   |              |
|--------------|-------------------|--------------|
| SW 1794      | LP 393-9906       | YT 220042501 |
| HY 800018687 | TY 00591-73985-81 | YT 800018687 |

⚠ WARNING: Cancer - [www.P65Warnings.ca.gov](http://www.P65Warnings.ca.gov)



Part Number - 062595-004

On (momentary)-none-on  
DPDT

▼ OEM

|              |                   |             |
|--------------|-------------------|-------------|
| SW 1795      | TY 00591-73981-81 | SW 1832     |
| HY 800018667 | YT 800018667      | LP 393-7922 |
| LP 393-9907  |                   |             |

⚠ WARNING: Cancer - [www.P65Warnings.ca.gov](http://www.P65Warnings.ca.gov)



Part Number - 360038-275

Master on-off switch

▼ OEM

|               |               |                   |
|---------------|---------------|-------------------|
| AC 305493-000 | PM 305493-000 | RA 939-352-217    |
| BT 305493-000 | RA 305493-000 | TY 00590-40983-71 |
| KO 305493-000 |               |                   |





**Part Number - 109759**

600vac  
12A

▼OEM

|              |                   |              |
|--------------|-------------------|--------------|
| SW 1377      | TY 00591-32296-81 | YT 220015021 |
| CL 7004135   | TY 00591-60557-81 | YT 800058911 |
| HY 800058911 | TY 00591-70676-81 |              |



**Part Number - 109758**

600vac  
12A

▼OEM

|                   |                   |                   |
|-------------------|-------------------|-------------------|
| SW 1348           | TY 00591-32290-81 | TY 00591-60556-81 |
| HY 3013965        | TY 00591-52550-81 | YT 220003692      |
| TY 00591-05093-81 |                   |                   |



**Part Number - 089362-00S**

Operating Force 6.5 oz min.  
15A @ 125 and 250vac  
0.6A @ 125vdc  
0.3A @ 250vdc

▼OEM

|              |                   |                   |
|--------------|-------------------|-------------------|
| CL 444113    | LP 393-8125       | TY 00591-57447-81 |
| HY 3012366   | TO 215930         | YT 220003207      |
| HY 800076716 | TY 00591-05049-81 | YT 220030452      |
| SW 1283      | TY 00591-32276-81 | YT 800076716      |



**Part Number - 073363**

Operating Force 7-13 oz  
Single Throw  
Single Pole  
Normally Open

▼OEM

|            |                   |                   |
|------------|-------------------|-------------------|
| CL 7004066 | TY 00591-32235-81 | TY 00591-60634-81 |
| SW 1207    |                   |                   |



**Part Number - 082605**

15A @ 30vdc

▼OEM

|              |             |              |
|--------------|-------------|--------------|
| BA LF021874  | SW 2154     | YT 220016301 |
| HY 800076416 | LP 393-2533 | YT 800076416 |



**Part Number - 062714**

15A  
SPDT  
Operating Force 90 grams max.

▼OEM

|         |             |
|---------|-------------|
| SW 1831 | LP 393-7921 |
|---------|-------------|

**Part Number - 147014**



(spade connectors)

General Purpose  
Single Throw  
Single Pole  
Normally Open  
2A 48VDC



(screw-on connectors)

▼OEM

|               |                   |                   |
|---------------|-------------------|-------------------|
| CL 7004060    | HY 800019130      | TY 00591-60635-81 |
| CT A000031300 | MB A000031300     | YT 220014587      |
| CT 216161     | MB 216161         | YT 800019130      |
| GE 3ASM5A3B3  | TO 216161         |                   |
| HY 3012350    | TY 00591-32227-81 |                   |



**Part Number - 073375**

15A @ 125vac & 250vac  
SPDT  
Operating Force 20 oz max

▼OEM

|              |                   |                   |
|--------------|-------------------|-------------------|
| CL 443898    | SW 1227           | TY 00591-57409-81 |
| CL 946483    | LP 393-2500       | YT 220003926      |
| CL 7004078   | TO 216162         | YT 800076075      |
| HY 3015165   | TY 00591-04651-81 |                   |
| HY 800076075 | TY 00591-32247-81 |                   |



**Part Number - 113352**

15A @ 1/2 HP 125/250vac  
SPDT

▼OEM

|         |             |
|---------|-------------|
| SW 1897 | LP 393-2798 |
|---------|-------------|



**Part Number - 082813**

Operating force 45 oz. max.  
Double Pole, Double Throw  
Normally Closed

▼OEM

|              |                   |              |
|--------------|-------------------|--------------|
| CL 7004134   | TY 00591-41846-81 | YT 220014503 |
| HY 800058813 | TY 00591-60694-81 | YT 800058813 |
| SW 1376      | TY 00591-70619-81 |              |



**Part Number - 088294**

Operating Force 7.8 max.

▼OEM

|              |                   |              |
|--------------|-------------------|--------------|
| CL 7004239   | SW 429            | YT 800076690 |
| HY 800076690 | TY 00591-32345-81 |              |



**Part Number - 101589**

Operating Force 15 oz max  
15A @ 125vac and 250vac

▼OEM

|              |                   |                   |
|--------------|-------------------|-------------------|
| CL 7004122   | TO 216135         | TY 00591-60538-81 |
| HY 800075101 | TY 00591-04181-81 | YT 220016504      |
| SW 1359      | TY 00591-32291-81 | YT 800075101      |



**Part Number - 077656**

15A, 250vac  
SPDT  
Operating Force 14-20 oz.

▼OEM

|              |                   |              |
|--------------|-------------------|--------------|
| BA 130091    | SW 32             | YT 6202871   |
| BA 985383    | SW 33             | YT 220023939 |
| BA 985838    | SW 342            | YT 220037742 |
| BA 986600    | SW 344            | YT 220043325 |
| BA 997030    | LP 393-2160       | YT 220051993 |
| BA 177MJH1   | LP 393-2172       | YT 500205100 |
| BA BZ2RQ13A2 | RA 1-150-324      | YT 600287100 |
| BA BZ2RQ1A2  | RA 590-023        | YT 620287100 |
| BA PAL32     | RA 590-058        | YT 620287101 |
| BA PAL-32A   | RA DS226498       | YT 62028710A |
| CL 991179    | TO 0972328        |              |
| HY 1371673   | TO 1009550        |              |
| HY 2307677   | TY 00591-32333-81 |              |
| HY 3007411   | TY 00591-51917-81 |              |
| HY 3008403   | TY 4516581100-71  |              |



**Part Number - 072007**

25A - 125-250vac  
1 HP @ 125vac  
2 HP @ 250vac  
Operating Force 30 oz max.

▼OEM

|            |                   |              |
|------------|-------------------|--------------|
| CL 7004058 | TY 00591-41779-81 | YT 220021468 |
| SW 1197    | TY 00591-60632-81 |              |



**Part Number - 078879**

25A 125 - 250vac  
1 HP @ 125vac  
2 HP @ 250vac  
Operating Force 30 oz max.

▼OEM

|            |                   |              |
|------------|-------------------|--------------|
| CL 7004059 | TO 215965         | YT 220002205 |
| HY 3017812 | TY 00591-32226-81 |              |
| SW 1198    | TY 00591-60668-81 |              |



**Part Number - 079133**

15A, 125-250vac  
¼ HP @ 125vac  
1½ HP @ 250vac  
Operating Force 15 oz max.

▼OEM

|              |                   |                   |
|--------------|-------------------|-------------------|
| CL 7004092   | LP 393-8216       | TY 00591-60672-81 |
| HY 800076274 | TO 216134         | YT 220015887      |
| SW 1275      | TY 00591-32271-81 | YT 800076274      |



**Part Number - 077133-001**

Blue  
10A @ 28vdc

▼OEM

|              |                   |              |
|--------------|-------------------|--------------|
| CL 7004054   | TO 216159         | YT 220013133 |
| HY 3013964   | TY 00591-04742-81 | YT 800076207 |
| HY 800076207 | TY 00591-32220-81 |              |
| SW 1191      | TY 00591-52537-81 |              |

⚠ WARNING: Cancer - [www.P65Warnings.ca.gov](http://www.P65Warnings.ca.gov)



**Part Number - 370575**

**Switch**

▼OEM

|                  |                  |                   |
|------------------|------------------|-------------------|
| BK 72-2085/53008 | LI 72-2085/53008 | TY 00591-32244-81 |
| CL 7004076       | RA 1130363-KIT   | TY 00591-63083-81 |
| DS P181-0013     | RA 1-150-028     | TY 00591-70165-81 |
| HY 3005701       | RA 821-003-202   | YT 220001752      |



**Part Number - 077133-002**

Black  
SPDT  
10A @ 28vdc

▼OEM

|              |                   |                   |
|--------------|-------------------|-------------------|
| CL 7004055   | TO 216155         | TY 00591-60663-81 |
| HY 800076208 | TY 00591-04743-81 | YT 220003691      |
| SW 1192      | TY 00591-32221-81 |                   |

⚠ WARNING: Cancer - [www.P65Warnings.ca.gov](http://www.P65Warnings.ca.gov)



**Part Number - 062683**

Operating force 75 grams max  
Release force 10 grams min  
SPDT with gold contacts

▼OEM

|              |                   |              |
|--------------|-------------------|--------------|
| HY 800018685 | LP 393-2325       | YT 800018685 |
| SW 1643      | TY 00591-73984-81 |              |



**Part Number - 086221**

▼OEM

|              |                   |                   |
|--------------|-------------------|-------------------|
| CL 7004131   | LP 393-7910       | TY 00591-70648-81 |
| HY 800058861 | TY 00591-41845-81 | YT 220014951      |
| SW 1373      | TY 00591-60714-81 | YT 800058861      |



**Part Number - 075198**

Single pole - double throw  
Operating force 8 oz  
Release force 4 oz

▼OEM

|                 |                   |                |
|-----------------|-------------------|----------------|
| AC 4932316      | LP 393-4230       | YT 015804500   |
| AC 74932316     | PM 201199         | YT 052332800   |
| BA 992567       | PM QU-161A8598G1  | YT 220023578   |
| BR A27350-6     | RA 1150-034       | YT 220024965   |
| CL 996101       | RA 1150-322       | YT 220051040   |
| HY 1194848      | RA 921-000/224    | YT 500742800   |
| HY 3008482      | RA DS226131       | YT 721260301   |
| HY 3012351      | TO 0972065        | YT 721260303   |
| HY 800076158    | TO 1009548        | YT 800076158   |
| HY 800076269    | TY 00591-04789-81 | YT 800076269   |
| HY A3720        | TY 00591-32318-81 | YT 0136151CB   |
| SW 151CB        | TY 00591-51929-81 | YT 136151-CB   |
| KO 7870-30-7120 | TY 00591-51930-81 | YT 549-GS-92-A |
| KO 7870-30-7210 | YT 015804300      | YT 549-GS-92-B |
| KO 78703-07210  | YT 015804400      | YT 6136151CB   |
| LP 393-4219     |                   |                |





**Part Number - 062766**

10 A @ 115/230 ½ HP  
2 circuit, 1 Normally Open, 1 Normally Closed Double Break

▼ OEM

|                 |                   |                |
|-----------------|-------------------|----------------|
| AC 4932316      | PM 201199         | YT 015804400   |
| AC 74932316     | PM QU-161A8598G1  | YT 015804500   |
| BA 992567       | RA 1150-034       | YT 052332800   |
| BR 27350-006    | RA 1-150-322      | YT 220023578   |
| BR A27350-6     | RA 921-000-224    | YT 220024965   |
| BR A-27350-6    | RA DS226131       | YT 220051040   |
| CL 996101       | TO 0972065        | YT 500742800   |
| HY 1194848      | TO 972065         | YT 721260301   |
| HY 3008482      | TO 1009548        | YT 721260303   |
| HY 3012351      | TY 00591-04789-81 | YT 800076158   |
| HY 800076158    | TY 00591-32318-81 | YT 800076269   |
| HY 800076269    | TY 00591-51929-81 | YT 0136151CB   |
| HY A-3720       | TY 00591-51930-81 | YT 549-GS-92-A |
| SW 151CB        | YT 158044         | YT 549-GS-92-B |
| KO 7870-30-7120 | YT 158045         | YT 6136151CB   |
| KO 78703-07210  | YT 523328         |                |
| LP 393-4219     | YT 5007428        |                |
| LP 393-4230     | YT 015804300      |                |



**Part Number - 370323**

**Micro Switch**

▼ OEM

|               |               |               |
|---------------|---------------|---------------|
| AC 306097-000 | KO 8734741    | RA 306097-000 |
| BT 306097-000 | PM 306097-000 |               |



**Part Number - 351096-278**

**Directional Switch**

▼ OEM

|              |
|--------------|
| RA 1-150-383 |
|--------------|



**Part Number - 087373**

Operating force 6.5 oz max  
Release force 1.5 oz min. 10A @ 30vdc

▼ OEM

|                 |                 |                   |
|-----------------|-----------------|-------------------|
| AC 4778736      | CL 7004253      | TO 9I2463         |
| AC 4795031      | CL 906619       | TO MCF00311       |
| AC 4798071      | DW 908450       | TO MCF00313       |
| AC 74778736     | HY 2304182      | TY 00591-32194-81 |
| AC 74795031     | HY 2311178      | TY 00591-32359-81 |
| AC 74798071     | HY 3016151      | TY 00591-51916-81 |
| BA 106944       | HY 519515302    | TY 00591-51928-81 |
| BA 106994       | SW 1039         | TY 00591-60541-81 |
| BA 709677       | SW 151FA        | YT 5148261        |
| BA 985402       | SW 1859         | YT 5152921        |
| BA 992717       | SW 983          | YT 220002082      |
| BA 177MBH1      | KO 34B-55-23610 | YT 220015035      |
| BA BXRW22A2     | KO 34B-55-23610 | YT 220015420      |
| BA BZ2RM22A2    | KO 34B-57-23610 | YT 220023943      |
| BA BZ2RW22A2    | KO 3BA-57-23610 | YT 220051964      |
| BA CB6          | LP 393-2142     | YT 514826100      |
| BA CB61         | LP 393-4172     | YT 515292100      |
| BA CB6-1        | PM 49965-00     | YT 01361510F      |
| BA CB6DASH1     | PM A49965       | YT 01361510N      |
| BK 3736759      | TO 0015949      | YT 0136151FA      |
| BR 28841-330    | TO 0060302      | YT 519515302      |
| BR 29000465-000 | TO 0300905      | YT 61361510F      |
| BR T29-465      | TO 0319033      | YT 61361510N      |
| BR T-29-465     | TO 0336130      | YT 6136151FA      |
| CL 1310067      | TO 0659968      | YT 61361510N      |
| CL 2795597      | TO 0908450      | YT 6136151FA      |
| CL 7004041      | TO 0972189      |                   |



**Part Number - 370249**

**Switch**

▼ OEM

|            |            |              |
|------------|------------|--------------|
| CL 1304793 | CL 3788232 | HY 3049726   |
| CL 2394430 | HY 2303007 | HY 3057595   |
| CL 2803519 | HY 3020121 | YT 519515301 |



**Part Number - 123437**

Operating force 8.5 oz max,  
Release force 1.5 oz min

▼ OEM

|              |              |              |
|--------------|--------------|--------------|
| IN SW-1595   | LP 393-2532  | YT 800108047 |
| HY 800108047 | YT 220035914 |              |



**Part Number - 062715**

Operating force 175 grams  
Release force 19 grams

▼ OEM

|         |             |             |
|---------|-------------|-------------|
| SW 1789 | LP 393-1939 | TO SE000006 |
| SW 1830 | LP 393-7920 |             |



**Part Number - 380050-044**

**Micro Switch**

▼ OEM

|                   |                   |               |
|-------------------|-------------------|---------------|
| CL 8027922        | TY 00591-51923-81 | YT 5170858-04 |
| TY 00590-00953-71 | TY 00591-62171-81 | YT 517085804  |
| TY 00591-06518-81 | TY 00591-74612-81 | YT 580004704  |
| TY 00591-32219-81 | YT 5042272-84     | YT 580004705  |
| TY 00591-41785-81 | YT 504227284      |               |



**Part Number - 073624**

Operating force 6 oz max  
Release force 1.5 oz min.  
15A @ 30vdc



**Part Number - 079267**

Operating Force 6 oz max  
25A @ 125/250vac  
1 HP @ 125vac  
2 HP @ 250vac

▼ OEM

|                   |                   |              |
|-------------------|-------------------|--------------|
| HY 800076277      | TY 00591-41801-81 | YT 220015460 |
| SW 1274           | TY 00591-60673-81 | YT 800076277 |
| TY 00591-04793-81 |                   |              |

## Switches - Snap Action



**Part Number - 360038-266**  
**Switch**

▼OEM

|               |                |                   |
|---------------|----------------|-------------------|
| AC 308030-000 | PM 308030-000  | RA 939-353/033    |
| BT 308030-000 | RA 308030-000  | TY 00590-43472-71 |
| KO 308030-000 | RA 939-353-033 |                   |



**Part Number - 370753**  
**Sealed Switch**

▼OEM

|              |
|--------------|
| HY 1498407   |
| YT 580025785 |



**Part Number - 370145**  
**Switch**

▼OEM

|              |
|--------------|
| HY 1486370   |
| YT 580019693 |



**Part Number - 360038-272**  
**Limit Switch**

▼OEM

|               |               |                   |
|---------------|---------------|-------------------|
| AC 20208-00   | HY 800138722  | RA 939-352-203    |
| AC 8730061    | HY 394077     | TC 20208          |
| AC OP03001097 | KO 20208-00   | TY 00590-00614-71 |
| BT 1-150-366  | KO 8730061    | TY 00590-40669-71 |
| BT 20208-00   | KO OP03001097 | TY 00591-03582-81 |
| BT P-20208    | PM 1-150-366  | TY 00591-32249-81 |
| CL 908622     | PM 20208-00   | TY 00591-63517-81 |
| CT 1075093    | PM P-20208    | YT 800138722      |
| HY 3055612    | RA 1-150-366  |                   |



**Part Number - 077481**  
**Switch**

▼OEM

|            |             |                   |
|------------|-------------|-------------------|
| CL 778570  | HY A121224  | TY 00591-04755-81 |
| HY 121224  | SW 1029     | TY 00591-41762-81 |
| HY 1198464 | LP 393-8115 | TY 00591-57445-81 |
| HY 3007247 | LP 393-9153 |                   |



**Part Number - 360038-274**  
**Lift Limit Switch**

▼OEM

|             |                |                   |
|-------------|----------------|-------------------|
| BT 20208-01 | RA 20208-01    | TY 00590-43475-71 |
| PM 20208-01 | RA 939-353-267 |                   |

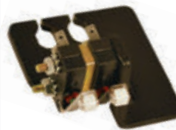

**Part Number - 370326**  
**Switch & Bracket Kit**

▼OEM

|               |               |               |
|---------------|---------------|---------------|
| AC OP03001122 | KO 8736071    | PM 308518-000 |
| BT 308518-000 | KO OP03001122 | RA 308518-000 |
| HY 800131447  |               |               |



**Part Number - 370775**  
**Switch**

▼OEM

|                |                |              |
|----------------|----------------|--------------|
| CT A0000-19284 | MB A0000-19284 | YT 580025784 |
| HY 1498406     | YT 580025784   |              |



**Part Number - 380500-644**  
**Emergency Disconnect Switch**

▼OEM

|                  |
|------------------|
| RA 1-150-313-057 |
|------------------|



**Part Number - 370649**  
**Disconnect Switch**

▼OEM

|              |
|--------------|
| YT 580019665 |
|--------------|

## Switches - Key

Continued ▶



**Part Number - 380050-040**  
**Ignition Switch**  
Includes: two keys

▼OEM

|            |                   |              |
|------------|-------------------|--------------|
| CL 7004147 | JU 14483690       | YT 504240854 |
| CT 216444  | TY 00591-06240-81 | YT 580007799 |
| HY 379902  | TY 00591-32300-81 | YT 580021375 |
| HY 379902  | TY 00591-51265-81 | YT 580022227 |
| HY 1492154 | TY 220003423      |              |
| HY 2035830 | TY 504240838      |              |



**Part Number - 380050-022**  
**Ignition Switch**

▼OEM

|                |
|----------------|
| NI 25150-02H01 |
|----------------|

*Note: Replacement keys not available*



**Part Number - 370556**  
**Switch - Key**

Includes: two keys - 3 terminal

▼OEM

|            |                   |
|------------|-------------------|
| CT 1009551 | RA 1-150-339      |
| CT 1086859 | RA DS224390       |
| CT 1086860 | TY 00590-00531-71 |
| HY 3121840 | TY 00590-00532-71 |
| MB 1009551 | TY 00591-21062-81 |
| MB 1086859 | YT 220018476      |
| MB 1086860 |                   |



Part Number - 370501-257

**Ignition Switch**

▼OEM

- BT 851-200-055
- PM 851-200-055
- RA 851-200-055



Part Number - 370054

Includes: two keys

Note: Uses replacement keys-2  
370054-001

▼OEM

|             |                |                   |
|-------------|----------------|-------------------|
| AC 4734244  | HY 1197960     | RA 590-004        |
| BJ 20725    | HY 1197961     | RA 590-006        |
| BK 152202   | HY 2033697     | RA 812-001-255    |
| CL 1681146  | HY 2303433     | RA 921-000-887    |
| CL 2345332  | HY 2305167     | RA DS223177       |
| CL 2809875  | HY 254007      | RA DS224389       |
| CL 301728   | HY 3005833     | RA DS226396       |
| CL 352148   | HY 3052440     | SC 41-25093       |
| CL 3700309  | HY 3066611     | TA 71120          |
| CL 3853257  | HY A-3716      | TA 71-120-00      |
| CL 611885   | HY A-3716-1    | TY 00590-00613-71 |
| CL 613472   | HY A-3716-2    | TY 00591-01780-81 |
| CL 624112   | HY A-49164-A   | TY 00591-32356-81 |
| CL 624597   | HY A-49164A    | TY 00591-41881-81 |
| CL 678376   | MB 1009544     | TY 00591-41950-81 |
| CL 7004163  | MB 1055276     | TY 00591-51256-81 |
| CL 896614   | MB 1086860     | TY 00591-51257-81 |
| CT 972202   | MB 972202      | YT 16051600       |
| CT 1009544  | MB NA013888    | YT 47001100       |
| CT 1055276  | MB NA013889    | YT 50649900       |
| CT 972202   | MB NA013890    | YT 80142300       |
| CT NA013888 | PB 304387K     | YT 500863100      |
| CT NA013889 | PB 3304387K    | YT 500863101      |
| CT NA013890 | RA 114-010-175 | YT 500863102      |
| HY 254007   | RA 1-150-065   | YT 500863104      |
| HY 1197132  | RA 1-150-368   | YT 500863105      |
| HY 1197133  | RA 1-150-378   | YT 500863110      |
| HY 1197134  | RA 1-150-392   | YT 645082800      |
| HY 1197135  | RA 1020341/004 |                   |
| HY 1197136  | RA 154-005-697 |                   |



Part Number - 146286

Includes: two keys

▼OEM

|              |              |                   |
|--------------|--------------|-------------------|
| AC 14835-22  | HY 3005111   | MB A221           |
| AC 20151-00  | HY 3007557   | MB B2007          |
| AC 4003998   | HY 3056776   | PM 20151-00       |
| BK 130659    | HY 3144134   | PM P-20151        |
| BK 992516    | HY 800057763 | RA 20151-00       |
| BR 28842-300 | HY 800076063 | SC 31-40156       |
| BT 14835-22  | HY 800132257 | SC 33-12112       |
| BT 20151-00  | HY 800133230 | SC 33-12113       |
| CL 908586    | KO 14835-22  | SC 33-12130       |
| CL 919487    | KO 20151-00  | TC 20151          |
| CT 0053635   | KO 8730954   | TC P-20151        |
| CT 0338753   | LI 130659    | TY 00591-04645-81 |
| CT 0A221     | LI 992516    | TY 00591-07636-81 |
| CT 0B2007    | LI A1132     | TY 00591-51261-81 |
| CT 338753    | MB 0053635   | TY 220001540      |
| CT 53635     | MB 0338753   | TY 220020175      |
| CT A221      | MB 0A221     | TY 220044134      |
| CT B2007     | MB 0B2007    | YT 220001540      |
| ET 35046     | MB 338753    | YT 220020175      |
| HY 1049164   | MB 53635     | YT 220044134      |



Part Number - 380051-002

**Ignition Switch**

▼OEM

- NI 25150-GG10B
- NI 25150-GJ90B

Note: Replacement keys not available



Part Number - 108066

Includes: two keys

▼OEM

|                 |                   |                   |
|-----------------|-------------------|-------------------|
| AC 3EB-55-A3621 | HY 0202017        | MB 376938         |
| AC 4722682      | HY 0260873        | MB 971156         |
| AC 4848481      | HY 0272041        | MB 972252         |
| AC 4848483      | HY 0392891        | MB 972256         |
| AC 4910557      | HY 131116         | MB 972293         |
| AC 4913250      | HY 1328442        | MB 9X2143         |
| AC 4966572      | HY 181332         | ME SM7-85         |
| AD 56478640     | HY 186305         | MJ V4866/3        |
| AF 00304        | HY 202017         | NI 125-0017       |
| BR 125-0017     | HY 260873         | TN 47485          |
| CL 1659819      | HY 265211         | TY 00591-00142-81 |
| CL 1723186      | HY 272041         | TY 00591-03098-81 |
| CL 1756213      | HY 2798391        | TY 00591-06155-81 |
| CL 2339413      | HY 3001108        | TY 00591-32298-81 |
| CL 2342572      | HY 3001109        | TY 00591-32357-81 |
| CL 2342572R     | HY 3001875        | TY 00591-32361-81 |
| CL 2342572-R    | HY 3020087        | TY 00591-41956-81 |
| CL 2356172      | HY 3044816        | TY 00591-51251-81 |
| CL 2394129      | HY 3053416        | TY 00591-51255-81 |
| CL 3480033      | HY 3057812        | TY 00591-51259-81 |
| CL 668782       | HY 3122805        | TY 00591-51266-81 |
| CL 7004210      | HY 3124064        | TY 00591-60555-81 |
| CT 0366463      | HY 3135532        | TY 220000801      |
| CT 0971156      | HY 392891         | TY 220000860      |
| CT 0972252      | HY 55959          | TY 220002990      |
| CT 0972256      | HY 800000360      | TY 220003465      |
| CT 0972293      | HY 800013610      | TY 220012746      |
| CT 332270       | HY 800083450      | TY 220019875      |
| CT 354343       | JU 14491250       | TY 220027238      |
| CT 366463       | KO 31-242         | TY 220037812      |
| CT 376938       | KO 3EB-55-16190   | WM 10A18229       |
| CT 971156       | KO 3EB-55-A3621   | WM 203011631      |
| CT 972252       | KO 3EB-55-A3630   | YT 220000801      |
| CT 972256       | KO 4722682        | YT 220000860      |
| CT 972293       | KO 4783418        | YT 220002990      |
| CT 9X2143       | KO 4832941        | YT 220003465      |
| DR 1116553      | KO 4834418        | YT 220012746      |
| DR 116508       | KO 4845729        | YT 220019875      |
| DR D-1460       | KO 4848481        | YT 220027238      |
| DW 366463       | KO 4848483        | YT 220037812      |
| ET 35035        | KO 4910557        | YT 277236300      |
| ET 35041        | KO 4913250        | YT 330027845      |
| ET 35388        | LI KM31-242       | YT 330028829      |
| ET 35625        | LI KM3EB-55-A3621 | YT 330028830      |
| ET 35705        | MB 0366463        | YT 330033742      |
| ET 35746        | MB 0971156        | YT 330050314      |
| ET 35750        | MB 0972252        | YT 330050421      |
| HK 4966572      | MB 0972256        | YT 330050546      |
| HY 0055959      | MB 0972293        | YT 330051166      |
| HY 0131116      | MB 332270         | YT 330053819      |
| HY 0181332      | MB 354343         | YT 330058266      |
| HY 0186305      | MB 366463         | YT 504227254      |



Part Number - 370329

**Key Switch**

▼OEM

- HY 2057948
- YT 580037904

**Switches - Key**



Part Number - 062623

**Keyless Switch**

- Four Switch Positions
1. Accessories Only
  2. Off Position
  3. Accessories and Ignition
  4. Ignition and Start (Spring Return)

▼OEM

HY 800085364      LP 309-2271      YT 220025682  
 SW 1598      TY 00591-14061-81      YT 800085364  
 KO 31-608

Knurled Nut Replacement Part:  
 P.N. 340103



Part Number - 123455

**Key Switch Assembly**

- Three Switch Positions
1. Off
  2. "IGN" & "ACC" on
  3. "IGN" & "ST" on w/spring return to position 2

▼OEM

LP 309-2279      HY 800017037      YT800017037

Knurled Nut Replacement Part:  
 P.N. 340102



Part Number - 370765

**Key Switch Assembly**

▼OEM

HY 2058111

**Lift Truck Power Switch Keys**

| Part Number | Type       | Truck Series                                    |
|-------------|------------|---|
| 107151-001  | Molded     | Walkies, Pallet, Tuggers, PR, Wave              |
| 089216-001  | Not Molded |   |
| 107151-002  | Molded     | Reach, Turret, Stockpickers, Counterbalance, PR |
| 107543-001  | Not Molded |   |



107151-001



089216-001



107151-002



107543-001



Part Number - 380030-134

**Key**

▼OEM

NI KEY00-GB01A



Part Number - 370581

**Key for Gas Trucks**

▼OEM

NI KEY00-000X7



Part Number - 370235

**Key - 2 Pieces**

▼OEM

TY 57591-23330-71



370087

**Key - 2 Pieces**

Part Number    Notes

|            |                                   |
|------------|-----------------------------------|
| 370087     | Fits TVH and OEM Ignition Switch  |
| 370054-001 | Works with 370054 Ignition Switch |



370054-001

▼OEM

CL 7004106      HY 3131733      YT 220041746  
 CL 905512-R      TY 00591-16442-81      YT 500863106  
 HY 2309436      TY 00591-41818-81  
 HY 262798      YT 220014812



Part Number - 370328

**Key - 2 Pieces**

▼OEM

AC 8732356      HY 800063427      PM 302092-000  
 AC OP03001094      KO 302092-000      RA 302092-000  
 BT 302092-000      KO 8732356      YT 220031307  
 CL 919818      KO OP03001094  
 CT A000018907      MB A000018907



Part Number - 370303

**Key Set - 2**

▼OEM

YT 504240712

## Wire and Cable

### Power Cable

| Gauge | Color  | UL Rated | Bulk Part Number | 10 ft box<br>305 cm | 12 ft box<br>366 cm | 50 ft reel,<br>1,524 cm | 100 ft reel,<br>3,048 cm | 250 ft reel,<br>7,620 cm | 500 ft reel,<br>15,240 cm |
|-------|--------|----------|------------------|---------------------|---------------------|-------------------------|--------------------------|--------------------------|---------------------------|
| 6     | black  | UL       | 084568-010       |                     | 384568-012          |                         |                          |                          |                           |
| 4     | black  | UL       | 084569-105       | 384569-010          | 384569-012          | 384569-050              | 384569-105               | 384569-250               |                           |
| 4     | red    | UL       | 384575-001       |                     | 384575-012          | 384575-050              | 384575-100               |                          |                           |
| 2     | black  | UL       | 084570-100       |                     | 344570-012          | 344570-050              | 344570-100               |                          | 344570-500                |
| 2     | red    | UL       | 384576-001       |                     | 384576-012          | 384576-050              | 384576-100               |                          |                           |
| 1     | black  | UL       | 084571-100       |                     | 344571-012          | 344571-050              | 344571-100               |                          |                           |
| 1     | red    | UL       | 384571-001       |                     | 384571-012          | 384571-050-02           | 384571-100-02            |                          |                           |
| 1/0   | black  | UL       | 084572-021       |                     | 384572-012          | 384572-050              | 384572-100               |                          |                           |
| 1/0   | red    | UL       | 384574-001       |                     | 384574-012          | 384574-050              | 384574-100               |                          |                           |
| 2/0   | black  | UL       | 084573-013       |                     | 384573-012-B        |                         | 384573-100               | 384573-250               |                           |
| 2/0   | red    | UL       |                  |                     | 384573-012-R        |                         | 384573-100-02            | 384573-250-0R            |                           |
| 2/0   | red    | not UL   | 384573-013R      |                     | 384573-012R         |                         | 384573-013               |                          |                           |
| 2/0   | orange | not UL   | 384573-014O      |                     | 384573-012-O        |                         | 384573-014               |                          |                           |
| 3/0   | black  | UL       |                  |                     | 384579-012-B        |                         | 384579-100-01            |                          |                           |
| 3/0   | red    | UL       |                  |                     | 384579-012-R        |                         | 384579-100-02            |                          |                           |
| 4/0   | black  | UL       | 384577-100-01    |                     | 384577-012          |                         | 384577-100               |                          |                           |
| 4/0   | red    | UL       |                  |                     | 384577-012-R        |                         |                          |                          |                           |
| 4/0   | red    | not UL   | 384578-100-01    |                     | 384578-012          |                         | 384578-100               |                          |                           |

▲WARNING: Cancer and reproductive harm - [www.P65Warnings.ca.gov](http://www.P65Warnings.ca.gov)

### Control Cable

| AWG/<br>Wires | Bulk Part<br>Number | 25 ft,<br>762 cm | 50 ft reel,<br>1,524 cm | 100 ft reel,<br>3,048 cm | 200 ft reel,<br>6,096 cm | 250 ft reel,<br>7,620 cm | 500 ft reel,<br>15,240 cm | 1000 ft reel,<br>30,480 cm |
|---------------|---------------------|------------------|-------------------------|--------------------------|--------------------------|--------------------------|---------------------------|----------------------------|
| 18-12         | 119203-014          |                  |                         |                          |                          |                          | 119203-016                |                            |
| 18-9          | 119203-011          |                  |                         | 389203-011-01            |                          |                          |                           |                            |
| 18-8          | 119203-001          |                  | 389203-001-50           | 389203-001-01            | 389203-001-02            | 119203-002               | 119203-003                |                            |
| 18-6          | 389204-001-06       |                  |                         | 389204-100-06            |                          | 389204-250-06            | 389204-500-06             |                            |
| 18-5          | 119203-004          |                  | 389203-004-50           | 389203-004-01            |                          | 119203-005               | 119203-006                |                            |
| 18-4          | 087374-001          | 387374-025       |                         | 387374-100               |                          |                          |                           |                            |
| 18-3          | 119203-007          |                  |                         | 389203-007-01            |                          | 119203-008               | 119203-009                |                            |
| 18-2          | 079495-001          |                  | 389495-050              | 389495-100               |                          | 389495-250               |                           | 389495-001                 |

▲WARNING: Cancer and reproductive harm - [www.P65Warnings.ca.gov](http://www.P65Warnings.ca.gov)

### Aircraft Cable, Galvanized Steel

| Part<br>Number | 50 ft reel,<br>1,524 cm | 100 ft reel,<br>3,048 cm | 250 ft reel,<br>7,620 cm |
|----------------|-------------------------|--------------------------|--------------------------|
| 083189-137     | 383189-050              | 383189-100               | 083189-128               |

### Freezer Control Cable

| AWG/<br>Wires | Bulk Part<br>Number | 250 ft reel,<br>7,620 cm | 500 ft reel,<br>15,240 cm |
|---------------|---------------------|--------------------------|---------------------------|
| 18-8          | 151261-001          | 151261-002               | 151261-003                |
| 18-5          |                     | 351261-250               |                           |
| 18-3          | 151261-004          | 151261-005               | 151261-006                |

### Control Wire - Extra Flex

#22 AWG = 7/24/44 strands  
#18 AWG = 7/59/44 strands  
-50 C° to +105° C  
UL1095 listed



| Gauge | Color       | 100 ft reel,<br>3,048 cm | 500 ft reel,<br>15,240 cm |
|-------|-------------|--------------------------|---------------------------|
| 22    | black       | 126517-002               |                           |
| 22    | brown       | 126517-005               |                           |
| 22    | red         | 126517-008               |                           |
| 22    | orange      | 126517-011               |                           |
| 22    | yellow      | 126517-014               |                           |
| 22    | green       | 126517-017               |                           |
| 22    | blue        | 126517-020               |                           |
| 22    | violet      | 126517-023               |                           |
| 22    | gray        | 126517-026               |                           |
| 22    | white       | 126517-029               |                           |
| 18    | black       | 132187-002               | 132187-003                |
| 18    | brown       | 132187-005               | 132187-006                |
| 18    | red         | 132187-008               | 132187-009                |
| 18    | orange      | 132187-011               | 132187-012                |
| 18    | yellow      | 132187-014               | 132187-015                |
| 18    | green       | 132187-017               | 132187-018                |
| 18    | blue        | 132187-020               | 132187-021                |
| 18    | violet      | 132187-023               | 132187-024                |
| 18    | gray        | 132187-026               | 132187-027                |
| 18    | white       | 132187-029               | 132187-030                |
| 18    | red/white   | 132187-032               | 132187-033                |
| 18    | green/white | 132187-035               | 132187-036                |

▲WARNING: Cancer - [www.P65Warnings.ca.gov](http://www.P65Warnings.ca.gov)

### Control Wire

#18 AWG, 41 strands  
0.03 min thermoplastic insulation  
-40 C° to +105° C  
UL1015 listed



| Gauge | Color              | 100 ft reel,<br>3,048 cm |
|-------|--------------------|--------------------------|
| 18    | black              | 086563-002               |
| 18    | brown              | 086564-002               |
| 18    | red                | 086565-002               |
| 18    | orange             | 086566-002               |
| 18    | yellow             | 086567-002               |
| 18    | green              | 086568-002               |
| 18    | blue               | 086569-002               |
| 18    | violet             | 086570-002               |
| 18    | gray               | 086571-002               |
| 18    | white              | 086572-002               |
| 18    | red stripe/white   | 086573-002               |
| 18    | green stripe/white | 086574-002               |

**Small DIM**



| Part Number | Max Voltage | Amps | Ferraz/<br>Gould | Littelfuse | Bussmann |
|-------------|-------------|------|------------------|------------|----------|
| 340032-001  | 250Vac      | 1    | GDC1             | 312-1      | AGC1     |
| 340032-002  | 250Vac      | 2    | GDC2             | 312-2      | AGC2     |
| 340032-004  | 250Vac      | 4    | GDC4             | 312-4      | AGC4     |
| 340032-005  | 250Vac      | 5    | GDC5             | 312-5      | AGC5     |
| 340032-R06  | 250Vac      | 6    | GDC-R-6          | 312-6      | AGC-R-6  |
| 090132      | 250Vac      | 10   | GDC10            | 312-10     | AGC10    |
| 340032-015  | 32Vac       | 15   | GGC15            | 312-15     | AGC15    |
| 340032-020  | 32Vac       | 20   | GGC20            | 312-20     | AGC20    |
| 340032-030  | 32Vac       | 30   | GGC30            | 312-30     | AGC30    |

▲WARNING: Cancer and reproductive harm - [www.P65Warnings.ca.gov](http://www.P65Warnings.ca.gov)

**Small DIM**



| Part Number | Max Voltage | Amps | Ferraz/<br>Gould | Littelfuse | Bussmann |
|-------------|-------------|------|------------------|------------|----------|
| 340044-002  | 250Vac      | 2    | GSC2             | 239002     | GMD-2-R  |

▲WARNING: Cancer and reproductive harm - [www.P65Warnings.ca.gov](http://www.P65Warnings.ca.gov)

**Small DIM - Time Delay**



| Part Number | Max Voltage | Amps | Ferraz/<br>Gould | Littelfuse | Bussmann |
|-------------|-------------|------|------------------|------------|----------|
| 340039-025  | 250Vac      | 1/4  | GDL1-1/4         | 313250     | MDL-1/4  |
| 100645      |             | 1    | GDL7             | 313001     | MDL-1    |
| 340039-002  | 250Vac      | 2    | GDL2             | 313002     | MDL-2    |
| 340039-015  | 32Vac       | 15   | GDL15            | 313015     | MDL-15   |
| 100988      | 32Vac       | 20   | GDL20            | 313020     | MDL-20   |

▲WARNING: Cancer and reproductive harm - [www.P65Warnings.ca.gov](http://www.P65Warnings.ca.gov)

**Small DIM**



| Part Number | Max Voltage | Amps | Ferraz/<br>Gould | Littelfuse | Bussmann |
|-------------|-------------|------|------------------|------------|----------|
| 340049-001  | 250Vac      | 1    | GGM1             | 235001     | GMA-1-R  |
| 094744      | 250Vac      | 3    | GGM3             | 235003     | GMA-3-R  |

▲WARNING: Cancer and reproductive harm - [www.P65Warnings.ca.gov](http://www.P65Warnings.ca.gov)

**Medium Time Delay**



| Part Number | Max Voltage | Amps | Ferraz/<br>Gould | Littelfuse | Bussmann |
|-------------|-------------|------|------------------|------------|----------|
| 340045-001  | 250Vac      | 1    | GSC1             | 235-1      | GMC-1-R  |
| 340045-005  | 125Vac      | 5    | GSC5             | 235-5      | GMC-5-R  |

▲WARNING: Cancer and reproductive harm - [www.P65Warnings.ca.gov](http://www.P65Warnings.ca.gov)

**Time Delay - Low Breaking**



| Part Number | Max Voltage    | Amps | Ferraz/<br>Gould | Littelfuse | Bussmann |
|-------------|----------------|------|------------------|------------|----------|
| 127038-001  | 250Vac or less | 1/4  | GDG1/4           | 218.250    | GDC250mA |
| 340034-001  | 250Vac or less | 1    | GDG1             | 218.001    | GDC1     |

▲WARNING: Cancer and reproductive harm - [www.P65Warnings.ca.gov](http://www.P65Warnings.ca.gov)

**Semiconductor**



| Part Number | Max Voltage   | Amps | Ferraz/<br>Gould | Littelfuse | Bussmann |
|-------------|---------------|------|------------------|------------|----------|
| 340033-012  | 250Vac/125Vdc | 12   | 250VFA6X32       | 322-12     | GBB12R   |

▲WARNING: Cancer and reproductive harm - [www.P65Warnings.ca.gov](http://www.P65Warnings.ca.gov)

**Auto**



| Part Number | Max Voltage | Amps | Ferraz/<br>Gould | Littelfuse | Bussmann |
|-------------|-------------|------|------------------|------------|----------|
| 071902-001  | 32Vac       | 9    | 307007           | SFE9       | SFE9     |
| 071902-002  | 32Vac       | 14   | 307014           | SFE14      | SFE14    |

▲WARNING: Cancer and reproductive harm - [www.P65Warnings.ca.gov](http://www.P65Warnings.ca.gov)

**Fast Acting**



| Part Number | Amp | Max Voltage | Type | Littelfuse | Bussmann | A in | B in |
|-------------|-----|-------------|------|------------|----------|------|------|
| 084190      | 1/4 | 250         | AGX  | 361.250    | AGX1/4   | 1.0  | 0.25 |

▲WARNING: Cancer and reproductive harm - [www.P65Warnings.ca.gov](http://www.P65Warnings.ca.gov)

**Medium-Acting Radial Leaded Ceramic**



| Part Number | Amp  | Max Voltage | A mm | B mm | Littelfuse |
|-------------|------|-------------|------|------|------------|
| 052071-001  | 0.63 | 80          | 20   | 5    | 2010630    |
| 052071-002  | 2    | 100         | 20   | 5    | 234002     |
| 052071-003  | 10   | 100         | 20   | 5    | 234010     |

**Fast Acting**



| Part Number | Max Voltage   | Amp | Ferraz/<br>Gould | Littelfuse | Bussmann | A in | B in |
|-------------|---------------|-----|------------------|------------|----------|------|------|
| 094362-005  | 250Vac/125Vdc | 3/8 | GAB3/8           | 314.375    | ABC3/8   | 1.25 | 0.25 |
| 094362-004  | 250Vac/125Vdc | 3/4 | GAB3/4           | 314.75     | ABC3/4   | 1.25 | 0.25 |
| 094362-003  | 250Vac/125Vdc | 2   | GAB2             | 314.002    | ABC2     | 1.25 | 0.25 |
| 094362-008  | 250Vac/125Vdc | 3   | GAB3             | 314.003    | ABC3     | 1.25 | 0.25 |
| 094362-001  | 250Vac/125Vdc | 4   | GAB4             | 314.004    | ABC4     | 1.25 | 0.25 |
| 094362-006  | 250Vac/125Vdc | 5   | GAB5             | 314.005    | ABC5     | 1.25 | 0.25 |
| 094362-012  | 250Vac/125Vdc | 6   | GAB6             | 314.006    | ABC6     | 1.25 | 0.25 |
| 094362-013  | 250Vac/125Vdc | 8   | GAB8             | 314.008    | ABC8     | 1.25 | 0.25 |
| 094362-010  | 250Vac/125Vdc | 10  | GAB10            | 314.010    | ABC10    | 1.25 | 0.25 |
| 094362-002  | 250Vac/125Vdc | 15  | GAB15            | 314.015    | ABC15    | 1.25 | 0.25 |
| 094362-007  | 125Vac/125Vdc | 30  | GAB30            | 314.030    | ABC30    | 1.25 | 0.25 |
| 094362-009  |               |     | Shorting Bar     |            | NCC      | 1.25 | 0.25 |

▲WARNING: Cancer and reproductive harm - [www.P65Warnings.ca.gov](http://www.P65Warnings.ca.gov)

**Fast Acting**



| Part Number | Max Voltage    | Amp | Ferraz/<br>Gould | Littelfuse | Bussmann | A in | B in |
|-------------|----------------|-----|------------------|------------|----------|------|------|
| 094362-011  | 250Vac or less | 1   | GSA1             | 326001     | MDA1     | 1.25 | 0.25 |
| 094362-017  | 250Vac or less | 15  | GSA15            | 326015     | MDA15    | 1.25 | 0.25 |
| 094362-020  | 250Vac or less | 20  | GSA20            | 326020     | MDA20    | 1.25 | 0.25 |
| 340052-025  | 250Vac or less | 25  | GSA25            | 326025     | MDA25-R  | 1.25 | 0.25 |

▲WARNING: Cancer and reproductive harm - [www.P65Warnings.ca.gov](http://www.P65Warnings.ca.gov)

**Fast Acting General Purpose**



| Part Number | Max Voltage | Amps | Ferraz/<br>Gould | Littelfuse | Bussmann |
|-------------|-------------|------|------------------|------------|----------|
| 340038-005  | 600         | 5    | SBS005           | KLQ005     | KTQ5     |

**Ferrule - High Speed, Without Striker**



| Part Number | Max Voltage | Amps | Ferraz/<br>Gould | Littelfuse | Bussmann   |
|-------------|-------------|------|------------------|------------|------------|
| 340096-050  | 700         | 50   |                  |            | FWP-50A22F |

**Low Voltage, Time Delay, Supplementary**



| Part Number | Max            |      | Ferraz/<br>Gould |          |          |
|-------------|----------------|------|------------------|----------|----------|
|             | Voltage        | Amps | Littelfuse       | Bussmann |          |
| 066052-002  | 250Vac or less | 2.5  | FNM-2.5          | FLM-2.5  | FLM02.5T |
| 340042-004  | 250Vac or less | 4    | FNM-4            | FLM-4    | FNM-4    |
| 340042-005  | 250Vac or less | 5    | FNM-5            | FLM-5    | FNM-5    |
| 340042-006  | 250Vac or less | 6    | FNM-6            | FLM-6    | FNM-6    |
| 340042-010  | 250Vac or less | 10   | FNM-10           | FLM-10   | FNM-10   |
| 340042-030  | 125Vac or less | 30   | FNM-30           | FLM-30   | FNM-30   |

▲WARNING: Cancer and reproductive harm - [www.P65Warnings.ca.gov](http://www.P65Warnings.ca.gov)

**One Time General Purpose Fuse**



| Part Number | Max     |      | Ferraz/<br>Gould |          |        |
|-------------|---------|------|------------------|----------|--------|
|             | Voltage | Amps | Littelfuse       | Bussmann |        |
| 090125      | 250Vac  | 30   | OT-30            | NLN-30   | NON-30 |
| 340050-060  | 250 Vac | 60   | OT-60            | NLN-60   | NON-60 |

▲WARNING: Cancer and reproductive harm - [www.P65Warnings.ca.gov](http://www.P65Warnings.ca.gov)

**Low Voltage, Time-Delay, Branch Circuit, Rejection Type**



| Part Number | Max            |      | Ferraz/<br>Gould |           |           |
|-------------|----------------|------|------------------|-----------|-----------|
|             | Voltage        | Amps | Littelfuse       | Bussmann  |           |
| 340041-025  | 600Vac or less | 0.25 | FNQ-R-.25        | FLQ-R-.25 | FNQ-R-.25 |
| 340041-050  | 600Vac or less | 0.5  | FNQ-R-.5         | FLQ-R-.5  | FNQ-R-.5  |
| 340041-001  | 600Vac or less | 1    | FNQ-R-1          | FLQ-R-1   | FNQ-R-1   |
| 340041-035  | 600Vac or less | 3.5  | FNQ-R-3.5        | FLQ-R-3.5 | FNQ-R-3.5 |

▲WARNING: Cancer and reproductive harm - [www.P65Warnings.ca.gov](http://www.P65Warnings.ca.gov)

**Low Voltage, Fast Acting, Branch Circuit, Rejection Type**



| Part Number | Max            |      | Ferraz/<br>Gould |           |           |
|-------------|----------------|------|------------------|-----------|-----------|
|             | Voltage        | Amps | Littelfuse       | Bussmann  |           |
| 340037-005  | 600Vac or less | 1    | ATMR1            | KLK-R-1   | KTK-R-1   |
| 340037-001  | 600Vac or less | 1.5  | ATMR1.5          | KLK-R-1.5 | KTK-R-1.5 |
| 340037-004  | 600Vac or less | 4    | ATMR4            | KLK-R-4   | KTK-R-4   |
| 340037-012  | 600Vac or less | 12   | ATMR12           | KLK-R-12  | KTK-R-12  |
| 340037-015  | 600Vac or less | 15   | ATMR15           | KLK-R-15  | KTK-R-15  |
| 340037-020  | 600Vac or less | 20   | ATMR20           | KLK-R-20  | KTK-R-20  |
| 340037-025  | 600Vac or less | 25   | ATMR25           | KLK-R-25  | KTK-R-25  |
| 340037-030  | 600Vac or less | 30   | ATMR30           | KLK-R-30  | KTK-R-30  |

▲WARNING: Cancer and reproductive harm - [www.P65Warnings.ca.gov](http://www.P65Warnings.ca.gov)

**Low-Peak CC TD**



| Part Number | Max                  |      | Ferraz/<br>Gould |          |          |
|-------------|----------------------|------|------------------|----------|----------|
|             | Voltage              | Amps | Littelfuse       | Bussmann |          |
| 340030-003  | 150Vdc-300Vdc-600Vac | 3    | ATDR3            | KLMR3    | LP-CC-3  |
| 340030-004  | 150Vdc-300Vdc-600Vac | 4    | ATDR4            | KLMR4    | LP-CC-4  |
| 340030-005  | 150Vdc-300Vdc-600Vac | 5    | ATDR5            | KLMR5    | LP-CC-5  |
| 340030-006  | 150Vdc-300Vdc-600Vac | 6    | ATDR6            | KLMR6    | LP-CC-6  |
| 340030-008  | 150Vdc-300Vdc-600Vac | 8    | ATDR8            | KLMR8    | LP-CC-8  |
| 340030-010  | 150Vdc-300Vdc-600Vac | 10   | ATDR10           | KLMR10   | LP-CC-10 |
| 340030-015  | 150Vdc-300Vdc-600Vac | 15   | ATDR15           | KLMR15   | LP-CC-15 |
| 340030-020  | 150Vdc-300Vdc-600Vac | 20   | ATDR20           | KLMR20   | LP-CC-20 |
| 340030-030  | 150Vdc-300Vdc-600Vac | 30   | ATDR30           | KLMR30   | LP-CC-30 |

▲WARNING: Cancer and reproductive harm - [www.P65Warnings.ca.gov](http://www.P65Warnings.ca.gov)

**RK5 TD**



| Part Number | Max     |      | Ferraz/<br>Gould |              |             |
|-------------|---------|------|------------------|--------------|-------------|
|             | Voltage | Amps | Littelfuse       | Bussmann     |             |
| 340018-005  | 600     | 5    | TRS5R            | FLSR-R5      | FRS-R5      |
| 340018-006  | 600     | 6    | TRS6R            | FLSR-R6      | FRS-R6      |
| 340018-007  | 600     | 7    | TRS7R            | FLSR-R7      | FRS-R7      |
| 340018-008  | 600     | 8    | TRS8R            | FLSR-R8      | FRS-R8      |
| 340018-010  | 600     | 10   | TRS10R           | FLSR-R10     | FRS-R10     |
| 340018-012  | 600     | 12   | TRS12R           | FLSR-R12     | FRS-R12     |
| 340018-015  | 600     | 15   | TRS15R           | FLSR-R15     | FRS-R15     |
| 340018-017  | 600     | 17.5 | TRS17-1/2R       | FLSR-R17-1/2 | FRS-R17-1/2 |
| 340018-020  | 600     | 20   | TRS20R           | FLSR-R20     | FRS-R20     |
| 340018-025  | 600     | 25   | TRS25R           | FLSR-R25     | FRS-R25     |
| 340018-030  | 600     | 30   | TRS30R           | FLSR-R30     | FRS-R30     |
| 340018-035  | 600     | 35   | TRS35R           | FLSR-R35     | FRS-R35     |
| 340018-040  | 600     | 40   | TRS40R           | FLSR-R40     | FRS-R40     |
| 340018-045  | 600     | 45   | TRS45R           | FLSR-R45     | FRS-R45     |
| 340018-050  | 600     | 50   | TRS50R           | FLSR-R50     | FRS-R50     |
| 340018-060  | 600     | 60   | TRS60R           | FLSR-R60     | FRS-R60     |

▲WARNING: Cancer and reproductive harm - [www.P65Warnings.ca.gov](http://www.P65Warnings.ca.gov)

**Class H**



| Part Number | Max     |      | Ferraz/<br>Gould |          |       |
|-------------|---------|------|------------------|----------|-------|
|             | Voltage | Amps | Littelfuse       | Bussmann |       |
| 340015-006  | 600     | 6    | OTS6             | NLS6     | NOS6  |
| 340015-010  | 600     | 10   | OTS10            | NLS10    | NOS10 |
| 340015-015  | 600     | 15   | OTS15            | NLS15    | NOS15 |
| 340015-020  | 600     | 20   | OTS20            | NLS20    | NOS20 |
| 340015-025  | 600     | 25   | OTS25            | NLS25    | NOS25 |
| 340015-030  | 600     | 30   | OTS30            | NLS30    | NOS30 |
| 340015-035  | 600     | 35   | OTS35            | NLS35    | NOS35 |
| 340015-040  | 600     | 40   | OTS40            | NLS40    | NOS40 |
| 340015-045  | 600     | 45   | OTS45            | NLS45    | NOS45 |
| 340015-060  | 600     | 60   | OTS60            | NLS60    | NOS60 |

▲WARNING: Cancer and reproductive harm - [www.P65Warnings.ca.gov](http://www.P65Warnings.ca.gov)

**Low Peak, Dual Element, Time Delay**



| Part Number | Max           |                                | Ferraz/<br>Gould                  |                                   |                                      |
|-------------|---------------|--------------------------------|-----------------------------------|-----------------------------------|--------------------------------------|
|             | Voltage       | Amps                           | Littelfuse                        | Bussmann                          |                                      |
| 340031-028  | 600Vac/300Vdc | 2 <sup>9</sup> / <sub>10</sub> | AJT2 <sup>9</sup> / <sub>10</sub> | JTD2 <sup>9</sup> / <sub>10</sub> | LPJ-2 <sup>9</sup> / <sub>10</sub> S |
| 340031-010  | 600Vac/300Vdc | 10                             | AJT10                             | JTD10                             | LPJ-10SP                             |
| 340031-012  | 600Vac/300Vdc | 12                             | AJT12                             | JTD12                             | LPJ-12SP                             |
| 340031-015  | 600Vac/300Vdc | 15                             | AJT15                             | JTD15                             | LPJ-15SP                             |
| 340031-020  | 600Vac/300Vdc | 20                             | AJT20                             | JTD20                             | LPJ-20SP                             |
| 340031-025  | 600Vac/300Vdc | 25                             | AJT25                             | JTD25                             | LPJ-25SP                             |
| 340031-030  | 600Vac/300Vdc | 30                             | AJT30                             | JTD30                             | LPJ-30SP                             |
| 340031-035  | 600Vac/300Vdc | 35                             | AJT35                             | JTD35                             | LPJ-35SP                             |
| 340031-040  | 600Vac/300Vdc | 40                             | AJT40                             | JTD40                             | LPJ-40SP                             |
| 340031-044  | 600Vac/300Vdc | 45                             | AJT45                             | JTD45                             | LPJ-45SP                             |
| 340031-050  | 600Vac/300Vdc | 50                             | AJT50                             | JTD50                             | LPJ-50SP                             |
| 340031-060  | 600Vac/300Vdc | 60                             | AJT60                             | JTD60                             | LPJ-60SP                             |
| 340031-070* | 600Vac/300Vdc | 70                             | AJT70                             | JTD70                             | LPJ-70SP                             |
| 340031-080* | 600Vac/300Vdc | 80                             | AJT80                             | JTD80                             | LPJ-80SP                             |
| 340031-090* | 600Vac/300Vdc | 90                             | AJT90                             | JTD90                             | LPJ-90SP                             |
| 340031-125* | 600Vac/300Vdc | 125                            | AJT125                            | JTD125                            | LPJ-125SP                            |
| 340031-150* | 600Vac/300Vdc | 150                            | AJT150                            | JTD150                            | LPJ-150SP                            |
| 340031-175* | 600Vac/300Vdc | 175                            | AJT175                            | JTD175                            | LPJ-175SP                            |
| 340031-225* | 600Vac/300Vdc | 225                            | AJT225                            | JTD225                            | LPJ-225SP                            |
| 340031-400* | 600Vac/300Vdc | 400                            | AJT400                            | JTD400                            | LPJ-400SP                            |

\*- with terminals

▲WARNING: Cancer and reproductive harm - [www.P65Warnings.ca.gov](http://www.P65Warnings.ca.gov)

**Stud MTD**



| Part Number | Max Voltage | Amps | Ferraz/<br>Gould | Littelfuse | Bussmann |
|-------------|-------------|------|------------------|------------|----------|
| 132083-001  | 125         | 50   | CNN50            | CNN50      | ANN50    |
| 340016-060  | 125         | 60   | CNN60            | CNN60      | ANN60    |
| 340016-100  | 125         | 100  | CNN100           | CNN100     | ANN100   |
| 132083-008  | 125         | 125  | CNN125           | CNN125     | ANN125   |
| 132083-007  | 125         | 150  | CNN150           | CNN150     | ANN150   |
| 340016-175  | 125         | 175  | CNN175           | CNN175     | ANN175   |
| 132083-009  | 125         | 200  | CNN200           | CNN200     | ANN200   |
| 340016-225  | 125         | 225  | CNN225           | CNN225     | ANN225   |
| 340016-250  | 125         | 250  | CNN250           | CNN250     | ANN250   |
| 132083-005  | 125         | 300  | CNN300           | CNN300     | ANN300   |
| 340016-325  | 125         | 325  | CNN325           | CNN325     | ANN325   |
| 340016-350  | 125         | 350  | CNN350           | CNN350     | ANN350   |
| 132083-002  | 125         | 400  | CNN400           | CNN400     | ANN400   |
| 132083-003  | 125         | 500  | CNN500           | CNN500     | ANN500   |
| 132083-006  | 125         | 700  | CNN700           | CNN700     | ANN700   |
| 132083-004  | 125         | 800  | CNN800           | CNN800     | ANN800   |
| 340047-040  | 80          | 40   | CNL40            | CNL40      | ANL40    |
| 340047-050  | 80          | 50   | CNL50            | CNL50      | ANL50    |
| 340047-080  | 80          | 80   | CNL80            | CNL80      | ANL80    |
| 340047-100  | 80          | 100  | CNL100           | CNL100     | ANL100   |
| 340047-125  | 80          | 125  | CNL125           | CNL125     | ANL125   |
| 340047-175  | 80          | 175  | CNL175           | CNL175     | ANL175   |
| 340047-200  | 80          | 200  | CNL200           | CNL200     | ANL200   |
| 340047-250  | 80          | 250  | CNL250           | CNL250     | ANL250   |
| 340047-300  | 80          | 300  | CNL300           | CNL300     | ANL300   |
| 380102-029  | 80          | 325  | CNL325           | CNL325     | ANL325   |
| 340047-350  | 80          | 350  | CNL350           | CNL350     | ANL350   |
| 340047-400  | 80          | 400  | CNL400           | CNL400     | ANL400   |
| 340047-500  | 80          | 500  | CNL500           | CNL500     | ANL500   |
| 340047-600  | 80          | 600  | CNL600           | CNL600     | ANL600   |
| 340047-675  | 80          | 675  | CNL675           | CNL675     | ANL675   |

▲WARNING: Cancer and reproductive harm - [www.P65Warnings.ca.gov](http://www.P65Warnings.ca.gov)

**V-Fuse, Enclosed**



| Part Number | Max Voltage | Amps |
|-------------|-------------|------|
| 814995-002  | 24          | 50   |

**Specialty Fuse -  
Use in EE & ES applications**



| Part Number | Max Voltage | Amps | Ferraz/<br>Gould | Littelfuse | Bussmann |
|-------------|-------------|------|------------------|------------|----------|
| 143962-001  | 48          | 500  |                  | 0581500.T  |          |
| 143962-002  | 48          | 800  |                  | 0581800.T  |          |
| 143962-003  | 48          | 50   |                  | 0581050.T  |          |
| 143962-004  | 48          | 125  |                  | 581125     |          |

▲WARNING: Cancer - [www.P65Warnings.ca.gov](http://www.P65Warnings.ca.gov)

**Fuse Strip w/Housing for  
Battery Powered Vehicles -  
Fast Acting**



| Part Number | Max Voltage | Amps | Ferraz/<br>Gould | Littelfuse    | A mm | B mm |
|-------------|-------------|------|------------------|---------------|------|------|
| 802816-006  | 80          | 50   |                  | 157.5917.5501 | 60   | 9    |
| 806720-002  | 80          | 50   |                  | 157.5701.5501 | 60   | 11   |
| 806720-003  | 80          | 80   |                  | 157.5701.5801 | 60   | 11   |
| 802816-003  | 80          | 100  |                  | 157.5701.6101 | 60   | 11   |
| 802816-007  | 80          | 100  |                  | 157.5917.6101 | 60   | 9    |
| 802816-001  | 80          | 125  |                  | 157.5701.6121 | 60   | 11   |
| 802816-005  | 80          | 125  |                  | 157.5917.6121 | 60   | 9    |
| 802816-009  | 80          | 150  |                  | 157.5917.6151 | 60   | 9    |
| 802816-002  | 80          | 160  |                  | 157.5701.6161 | 60   | 11   |
| 802816-004  | 80          | 200  |                  | 157.5701.6201 | 60   | 11   |
| 802816-011  | 80          | 355  |                  | 157.5917.6351 | 60   | 9    |
| 802816-012  | 80          | 400  | Z228849          | 157.5701.6401 | 60   | 11   |
| 806720-001  | 80          | 425  |                  | 157.5701.642  | 60   | 11   |

**T-Tron Fast Acting**



| Part Number | Max Voltage    | Amps | Ferraz/<br>Gould | Littelfuse | Bussmann |
|-------------|----------------|------|------------------|------------|----------|
| 340046-001  | 300Vac or less | 70   | A3T70            | JLLN70     | JJN70    |
| 340046-080  | 300Vac or less | 80   | A3T80            | JLLN80     | JJN80    |
| 340046-003  | 300Vac or less | 150  | A3T150           | JLLN150    | JJN150   |
| 340046-300  | 300Vac or less | 300  | A3T300           | JLLN300    | JJN300   |
| 340046-004  | 300Vac or less | 350  | A3T350           | JLLN350    | JJN350   |
| 340046-400  | 300Vac or less | 400  | A3T400           | JLLN400    | JJN400   |
| 340046-005  | 300Vac or less | 450  | A3T450           | JLLN450    | JJN450   |

▲WARNING: Cancer and reproductive harm - [www.P65Warnings.ca.gov](http://www.P65Warnings.ca.gov)

**High Speed Fuse**



| Part Number | Max Voltage | Amps | Ferraz/<br>Gould | Littelfuse | Bussmann |
|-------------|-------------|------|------------------|------------|----------|
| 340017-080  | 150         | 80   | A15QS-80-4       | L15S80     | FWA-80B  |
| 340017-100  | 150         | 100  | A15QS-100-4      | L15S100    | FWA-100B |
| 340017-150  | 150         | 150  | A15QS-150-4      | L15S150    | FWA-150B |
| 340017-200  | 150         | 200  | A15QS-200-4      | L15S200    | FWA-200B |
| 340017-250  | 150         | 250  | A15QS-250-4      | L15S250    | FWA-250B |
| 091344      | 150         | 300  | A15QS-300-4      | L15S300    | FWA-300B |
| 340017-350  | 150         | 350  | A15QS-350-4      | L15S350    | FWA-350B |
| 340017-400  | 150         | 400  | A15QS-400-4      | L15S400    | FWA-400B |
| 340017-500  | 150         | 500  | A15QS-500-4      | L15S500    | FWA-500A |

▲WARNING: Cancer and reproductive harm - [www.P65Warnings.ca.gov](http://www.P65Warnings.ca.gov)

**Fast Acting Automotive Blade**



| Part Number | Max Voltage | Amps | Ferraz/<br>Gould | Littelfuse    | Bussmann | Type         |
|-------------|-------------|------|------------------|---------------|----------|--------------|
| 340077-001  | 32          | 1    | AF10             |               | ATC10    | Black        |
| 805751-002  | 32          | 2    | AF2              | 164.6185.4202 | ATC2     | Grey         |
| 805751-006  | 32          | 4    | AF4              | 166.7000.440  | ATC4     | Pink         |
| 340077-005  | 32          | 5    | AF5              |               | ATC5     | Tan          |
| 380500-223  | 32          | 7.5  | AF7.5            |               | ATC7.5   | Brown        |
| 805751-001  | 32          | 10   | AF10             | 164.6185.5102 | ATC10    | Red          |
| 340077-025  | 32          | 25   | AF25             |               | ATC25    | Natural      |
| 340077-030  | 32          | 30   | AF30             |               | ATC30    | Green        |
| 045979      | 32          | 80   |                  | 299080        |          | Clear        |
| ▲062765-003 | 32          | 4    |                  | 0287004       |          | Pink         |
| ▲062765-004 | 32          | 10   |                  | 0287010       |          | Red          |
| ▲062765-001 | 32          | 15   |                  | 0257015       |          | Blue         |
| 806703-002  | 80          | 5    |                  | 166.7000.450  |          | Light brown  |
| 806703-004  | 80          | 10   |                  | 166.7000-450  |          | Light red    |
| 806703-001  | 80          | 15   |                  | 166.7000.515  |          | Light blue   |
| 806703-005  | 80          | 20   |                  | 166.7000-520  |          | Light yellow |
| 806703-003  | 80          | 30   |                  | 166.7000-530  |          | Light green  |

▲WARNING: Cancer and reproductive harm - [www.P65Warnings.ca.gov](http://www.P65Warnings.ca.gov)



## Time Delay Fuse



| Part Number | Max Voltage | Amps | Ferraz/<br>Gould | Littelfuse | Bussmann |
|-------------|-------------|------|------------------|------------|----------|
| 076924-017  | 130         | 15   |                  | CCK15      | ACK15    |
| 076924-018  | 130         | 20   |                  | CCK20      | ACK20    |
| 076924-012  | 130         | 30   |                  | CCK30      | ACK30    |
| 076924-011  | 130         | 40   |                  | CCK40      | ACK40    |
| 076924-001  | 130         | 60   |                  | CCK60      | ACK60    |
| 076924-003  | 130         | 100  |                  |            | ALS100   |
| 076924-004  | 130         | 120  |                  |            | ACK120A  |
| 076924-005  | 130         | 140  |                  |            | ACK140   |
| 076924-014  | 130         | 160  |                  |            | ACK160   |
| 076924-006  | 130         | 175  |                  |            | ACK175   |
| 076924-016  | 130         | 175  |                  |            | ALS175B  |
| 076924-002  | 130         | 200  |                  |            | ALS200B  |
| 076924-007  | 130         | 200  |                  |            | ACK200   |
| 076924-015  | 130         | 225  |                  |            | ALS225B  |
| 076924-009  | 130         | 250  |                  |            | ALS250B  |
| 076924-020  | 130         | 250  |                  |            | ACK250   |
| 076924-010  | 130         | 300  |                  |            | ALS300B  |
| 076924-013  | 130         | 300  |                  |            | ACK300   |
| 076924-021  | 125         | 300  | ALS300           |            |          |
| 076924-022  | 125         | 300  | ACK300           |            |          |
| 076924-008  | 125         | 400  |                  |            | ALS400B  |
| 340051-500  | 125         | 500  | ALS500           |            |          |

▲WARNING: Cancer and reproductive harm - [www.P65Warnings.ca.gov](http://www.P65Warnings.ca.gov)

## In-Line Non-Rejecting



| Part Number | Max Voltage    | Amps | Ferraz/<br>Gould | Littelfuse | Bussmann |
|-------------|----------------|------|------------------|------------|----------|
| 340035-003  | 300Vac or less | 3    | SLR3             | LGR3       | GLR-3    |
| 340035-010  | 300Vac or less | 10   | SLR10            | LGR10      | GLR-10   |

▲WARNING: Cancer and reproductive harm - [www.P65Warnings.ca.gov](http://www.P65Warnings.ca.gov)

## Super-Lag Renewable

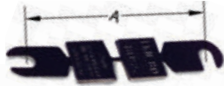

| Part Number | Max Voltage | Amps | Ferraz/<br>Gould | Littelfuse | Bussmann | A in  |
|-------------|-------------|------|------------------|------------|----------|-------|
| 081614      | 80          | 250  | RL80             | LKN80      | LKN80    | 2.56  |
| 076789      | 125         | 250  | RL125            | LKN125     | LKN125   | 2.625 |
| 074282      | 200         | 250  | RL200            | LKN200     | LKN200   | 2.625 |
| 071597      | 250         | 250  | RL250            | LKN250     | LKN250   | 2.625 |

▲WARNING: Cancer and reproductive harm - [www.P65Warnings.ca.gov](http://www.P65Warnings.ca.gov)

## Automotive ATM Mini Blade

| Part Number | Max Voltage | Amps | Littelfuse | Type   |
|-------------|-------------|------|------------|--------|
| 062897-001  | 42          | 5    | 997005     | Tan    |
| 062897-002  | 42          | 7.5  | 99707.5    | Brown  |
| 062897-003  | 42          | 10   | 997010     | Red    |
| 062897-004  | 42          | 15   | 997015     | Blue   |
| 062897-005  | 42          | 20   | 997020     | Yellow |
| 062897-006  | 42          | 2    | 997002     | Gray   |



▲WARNING: Cancer and reproductive harm - [www.P65Warnings.ca.gov](http://www.P65Warnings.ca.gov)

## Automotive BF1

| Part Number | Max Voltage | Amps | Ferraz/<br>Gould | Littelfuse    | Bussmann | Type  |
|-------------|-------------|------|------------------|---------------|----------|-------|
| 153739-001  | 58          | 40   |                  | 142.5631.5402 |          | Green |



▲WARNING: Cancer and reproductive harm - [www.P65Warnings.ca.gov](http://www.P65Warnings.ca.gov)

## Automotive Blade MAX

| Part Number | Max Voltage | Amps | Ferraz/<br>Gould | Littelfuse | Bussmann | Type |
|-------------|-------------|------|------------------|------------|----------|------|
| 340107-050  | 32          | 50   |                  |            | MAX50    | Red  |
| 340107-070  | 32          | 70   |                  |            | MAX70    | Tan  |



## J-Case, Slo-Blo Automotive Cartridge

| Part Number | Max Voltage | Amps | Type  | Littelfuse |
|-------------|-------------|------|-------|------------|
| 062902-003  | 32          | 40   | Green | 995-40     |



▲WARNING: Cancer and reproductive harm - [www.P65Warnings.ca.gov](http://www.P65Warnings.ca.gov)



Part Number - 370543

**Fuse**

2 Amp



Style A



Style B



Style C



Style D



Style E

**OEM Key**

AC = Allis Chalmers  
BR = Barrett

CL = Clark  
HY = Hyster  
JG = Jungheinrich

KO = Komatsu  
LP = LPM  
MT = Mitsubishi

NI = Nissan  
PM = Prime Mover  
RA = Raymond

TO = Caterpillar/Towmotor  
TY = Toyota  
YT = Yale

| Part Number | Style | Voltage | Amps | OEM  |   |  |
|-------------|-------|---------|------|--|---|--|
| 116794-002  | A     | 24      | 150  | HY 800075381<br>LP 375-1943  | LP 375-7809   | TY 00591-44166-81  |
| 116794-005  | A     | 24      | 150  | HY 800075380<br>LP 375-1948  | LP 375-6125   | TY 00591-44171-81  |
| 110613-001  | B     | 24      | 150  | LP 375-1945  | LP 375-3047   | TY 00591-44168-81  |
| 110613-002  | B     | 24      |      |  |   |  |
| 110613-003  | B     | 24      | 150  | HY 800064625<br>LP 375-1946  | LP 375-3048<br>TY 00591-44169-81  | TY 00591-72323-81<br>YT 520293803  |
| 110613-005  | B     | 36/48   | 150  | HY 800075255<br>LP 375-1947  | LP 375-3049   | TY 00591-44170-81  |
| 110613-007  | B     | 36      |      |  |   |  |
| 117853-001  | B     | 24      | 250  | HY 800000537   | LP 375-1073   |  |
| 120975      | B     | 24      | 100  | LP 375-1951<br>LP 375-3056   | TY 00591-44150-81   | YT 220043708   |
| 351096-270  | B     | 24      | 100  | RA 313066-000  |   |  |
| 370752      | B     | 36/48   | 180  | AC 3BA-55-34620<br>AC 8770584<br>BT 202170<br>CL 7005881<br>CT A0000-05433<br>CT A0000-09565<br>KO 3BA-55-34620<br>KO 8770584  | MB A0000-05433<br>MB A0000-09585<br>PM 202170<br>RA 202170<br>TY 00591-44134-81<br>TY 00591-44161-81<br>TY 00591-57021-81<br>TY 00591-57055-81  | TY 00591-72330-81<br>YT 504233261<br>YT 504736502  |
| 370758      | B     | 36/48   | 350  | CL 7006018<br>CT A0000-29527   | MB A0000-29527<br>YT 580046780  |  |
| 104483 ⚠    | C     | 24      | 150  | AC 4967344<br>AC 4967616<br>AC 4967618<br>AC 78730634<br>BR 39187-001<br>CL 4308934<br>CL 7001657<br>CL 912089<br>CL 912363<br>CL 913903<br>HY 0388227<br>HY 2014096<br>HY 0388227<br>HY 800082018<br>HY 800082021 | JG 14480230<br>JG 14520932<br>KO 200098<br>KO 24205-01<br>27 692-00<br>KO 3BA-47-A4170<br>KO 3WB-47-A1530<br>LP 375-7100-GE<br>MT 9712402600<br>MT 97C5701100<br>PM 7692-00<br>PM 200098<br>PM 27692<br>RA 1-105-204<br>TO 9712402600 | TO 97C5701100<br>TY 00591-04280-81<br>TY 00591-23819-81<br>TY 00591-30734-81<br>TY 00591-51694-81<br>TY 00591-30736-81<br>YT 501227249<br>YT 504227249<br>YT 505075506<br>YT 220023787<br>YT 220073460<br>YT 800082018<br>YT 800082021 |
| 111634 ⚠    | C     | 24      | 100  | CL 914626<br>HY 800082008<br>LP 375-7117-GE  | NI CK914626<br>PM 201348<br>PM QU-IC2800M254C4B   | TY 00591-23809-81<br>TY 0059-136799-81<br>TY 0059-151676-81  |
| 370233      | C     | 24      | 300  | YT 505075522   |   |  |
| 370234      | C     | 36/48   | 150  | HY 1301515   |   |  |
| 093575      | D     | 24      |      | CL 7001616<br>LP 375-6121<br>LP 375-6121-GE  | PM 201354<br>PM QU-IC0M611AA13A<br>TO 216138  | TY 00591-30691-81<br>TY 00591-51691-81<br>YT 220003286   |
| 093576      | D     | 24      |      | CL 7001619<br>LP 375-6006  | TY 00591-30695-81   | YT 220003287   |
| 093574      | D     | 24      |      | LP 375-6129<br>PM 201356   | PM QU-IC0M611AC13A<br>TY 00591-30692-81   | YT 220003285   |
| 112329      | D     |         |      | CL 7001619<br>LP 375-6006  | TY 00591-30695-81   | YT 220003287   |
| 112329-002  | D     |         |      |  |   |  |
| 116962      | D     |         |      | HY 800075391   | LP 375-7833   |  |
| 112328      | D     |         |      | HY 800076791   | LP 375-6008   |  |
| 112327 ⚠    | D     |         |      | HY 800020423   | LP 375-6007   |  |

⚠WARNING: Cancer and reproductive harm - [www.P65Warnings.ca.gov](http://www.P65Warnings.ca.gov)

# Contactors



Style E



Style F



Style G



Style H



Style I



Style J

**OEM Key**

AC = Allis Chalmers  
BR = Barrett

CL = Clark  
HY = Hyster  
JG = Jungheinrich

KO = Komatsu  
LP = LPM  
MT = Mitsubishi

NI = Nissan  
PM = Prime Mover  
RA = Raymond

TO = Caterpillar/Towmotor  
TY = Toyota  
YT = Yale

| Part Number  | Style | Voltage | Amps | OEM  |   |   |
|--------------|-------|---------|------|--|---|---|
| 104140       | E     | 24      | 150  | BR 28841-654<br>BR 39186-001<br>CL 912091<br>KO 3WB-47-A1540<br>KO GA150AH124XN<br>LP 375-7101-GE  | PM 200100<br>PM 26673-02<br>PM 27693-02<br>TO 97124-02800<br>TY 00591-30732-81  | TY 00591-51695-81<br>YT 220015003<br>YT 220023784<br>YT 5042242-80<br>YT 5050755-07 |
| 106109-001 🚧 | E     | 36      | 150  | AC 8730877<br>CL 912094<br>HY 3055351<br>HY 388016<br>LP 375-7113-GE   | NI CK912094<br>PM 202169<br>PM 27693-04<br>YT 220023785<br>TY 00591-23814-81  | TY 00591-36801-81<br>TY 00591-57039-81<br>TY 00591-60549-81                         |
| 106109-003 🚧 | E     | 36-48   | 150  | CL 915631<br>HY 1300938<br>HY 800082014<br>LP 375-7113-GE  | MT 97122-06600<br>TO 9712206600<br>TY 00591-23815-81  | TY 00591-30733-81<br>TY 00591-57037-81<br>YT 220026251                              |
| 370534       | E     | 24      | 330  | AC 312258-000<br>AC OP03000407<br>CT 1050553<br>CT 300A-24B1M25RS00-25D<br>CT 300A-24B1M4RS01-30E<br>CT 300A-24B5M48RS02-18A<br>CT NA013405<br>CT NA015455 | KO 312258-000<br>KO OP03000407<br>MB 1050553<br>MB 300A-24B1M4RS01-30E<br>MB 300A-24B5M48RS02-18A<br>MB NA013405<br>MB NA015455<br>RA 1-105-122 | RA 1-105-128/100<br>RA 1-105-153/100  |
| 118396       | F     | 24      | 150  | HY 800075421<br>LP 375-1949  | LP 375-3018   | TY 00591-44144-81   |
| 370153       | G     | 36      |      | CL 444238<br>CT 0083636<br>CT 0399717  | MB 0083636<br>PL 66-061<br>PL HB409KC360EA  | PL JAF-4004D<br>TY 00591-20262-81<br>YT 220013711                                   |
| 380030-002   | H     | 24      |      | HM CTR-24-280  | YT 519832602  | YT DC88-207   |
| 380030-085   | I     | 36      |      | TY 24420-13300-71  |   |   |
| 370732       | I     | 36      |      | CL 448606  | TY 24410-13301-71   |   |
| 370743       | I     | 36      |      | TY 24410-12230-71  |   |   |
| 380030-086   | J     | 24      |      | HY 2305835<br>HY 2307724   | YT 505175502  | YT 505175504  |

⚠️ **WARNING:** Cancer and reproductive harm - [www.P65Warnings.ca.gov](http://www.P65Warnings.ca.gov)

## Contactor Tip and Tip Kits



Part Number - 370183

### Contactor Tip

▼ OEM Reference

|                |                   |                   |
|----------------|-------------------|-------------------|
| CL 7000194     | NI 29348-L4005GN  | TY 00591-31635-81 |
| CT 218004      | NI 29366-40H10    | TY 00591-32654-81 |
| DS P115-0011   | TB 10-1131        | TY 00591-51875-81 |
| HY 3000709     | TC AB-MSD4-1520   | UC 8015           |
| HY 3000709T    | TC ABMSD-41520    | YT 220070387      |
| KO FBMSD-41520 | TC ABMSD-41521    |                   |
| NI 29348-L4005 | TY 00591-07282-81 |                   |



Part Number - 380030-186

### Contactor Tip

▼ OEM Reference

|            |                   |                   |
|------------|-------------------|-------------------|
| CT 912775  | HY 00591-10779-81 | TY 24422-13300-71 |
| HY 3056135 | HY 00591-73486-81 | YT 220024698      |
| HY 3133098 | HY 24422-13301-71 |                   |



Part Number - 380030-187

### Contactor Tip

▼ OEM Reference

|              |                   |              |
|--------------|-------------------|--------------|
| CT 912776    | TY 24421-13300-71 | YT 220027574 |
| HY 3135696   | TY 00591-10778-81 |              |
| HY 800121715 | TY 24421-13301-71 |              |



Part Number - 380030-190

### Contactor Tip Kit

▼ OEM Reference

YT 24450-13300-71



Part Number - 370339

### Contactor Tip Kit

▼ OEM Reference

|                   |                   |                   |
|-------------------|-------------------|-------------------|
| HY 800130113      | TY 04924-10220-71 | TY 24470-13300-71 |
| HY 800136872      | TY 04924-10230-71 |                   |
| TY 04924-10210-71 | TY 24460-13300-71 |                   |



Part Number - 370072-001

### Contactor Tip Kit - 450 amp

▼ OEM Reference

|                    |
|--------------------|
| RA 1-105-129-111   |
| RA 154-008-740-416 |
| RA DS223295        |
| RA DS232734        |



Part Number - 370071

### Contactor Tip Kit

▼ OEM Reference

|              |                    |                   |
|--------------|--------------------|-------------------|
| DS P111-0030 | PL JEA-3003S       | TY 00591-07577-81 |
| DS P111-0104 | PL K2096-10        | TY 00591-53115-81 |
| HY 1316399   | RA 1-105-055-02    | TY 00591-57340-81 |
| PL 67-042    | RA 154-008-741-216 |                   |
| PL JCA-3003S | TB 10-1K38         |                   |



Part Number - 370072

### Contactor Tip Kit

▼ OEM Reference

|                   |                   |              |
|-------------------|-------------------|--------------|
| CT 1051087        | TY 00591-39838-81 | YT 220017209 |
| DS P103-0050      | TY 00591-57328-81 | YT 220034535 |
| TY 00591-21059-81 | HY 3039475        |              |



Part Number - 370070

### Contactor Tip Kit

▼ OEM Reference

|              |                 |                   |
|--------------|-----------------|-------------------|
| AC 4912002   | HY 3006743      | TB 10-1K23        |
| CL 996819    | NK 118311       | TB 10-1K27        |
| CL 7003151   | PL 67-029       | TY 00591-09003-81 |
| CL 7003190   | PL JBC-3001S    | TY 00591-31595-81 |
| CT 217526    | RA 1-105-023-04 | TY 00591-31603-81 |
| DS P111-0032 | SC 29-10413     | TY 00591-31636-81 |
| DS P111-0044 | SC 33-14640     | TY 00591-51868-81 |
| HY 3000614   | SC 39-90057     | TY 00591-63174-81 |



Part Number - 380030-084

### Contactor Tip Kit

▼ OEM Reference

|              |
|--------------|
| HY 2305749   |
| YT 150091008 |



Part Number - 104651

### Contact Kit

▼ OEM Reference

|             |                   |                   |
|-------------|-------------------|-------------------|
| CL 7003192  | LP 379-8233       | TY 00591-60521-81 |
| CL 919410   | LP 379-8233-GE    | TY 00591-60546-81 |
| GE 154FR    | PM 301741-000     | TY 00591-76469-81 |
| GE 154FR-CS | TY 00591-04237-81 | YT 150091011      |
| HY 0996112  | TY 00591-23705-81 | YT 220007903      |
| HY 3054391  | TY 00591-31517-81 | YT 220021935      |
| HY 996112   | TY 00591-39817-81 |                   |



**Part Number - 3C0001-R**  
**Curtis PMC Control**  
 ▼ OEM Reference  
 FL 1204-021  
 HY 3181079  
 TA 62-204-00  
 YT 150105667



**Part Number - 3C0031-R**  
**Curtis PMC Control**  
 ▼ OEM Reference  
 FL 77-1243C-4384  
 YT 580030492



**Part Number - 3C0003-R**  
**Curtis PMC Control**  
 ▼ OEM Reference  
 FL 1205X-4417  
 HY 1500220-25  
 HY 3033962  
 YT 150022025  
 YT 518361610  
 YT 220015258

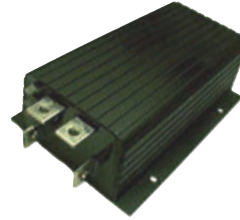

**Part Number - 3C0009-R**  
**Curtis PMC Control**  
 ▼ OEM Reference  
 FL 1204-001  
 TA CTL-2000

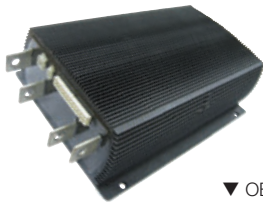

**Part Number - 3C0005-R**  
**Curtis PMC Control**

▼ OEM Reference

|              |              |              |
|--------------|--------------|--------------|
| CU 831722    | HY 3175374   | YT 150022574 |
| EZ 27094G01  | HY 3183796   | YT 150022684 |
| FL 1204-001  | RA 1-187-085 | YT 150120773 |
| FL 1214-8708 | RA 1017149   | YT 220011997 |
| FL 1214-8709 | RA 1017150   | YT 220175374 |
| HY 3026554   | TA CTL-2000  |              |



**Part Number - 3C0030-R**  
**Curtis PMC Control**  
 ▼ OEM Reference  
 FL 77-1205-108  
 TA 62-205-00



**Part Number - 3C0017-R**  
**Curtis PMC Control**  
 ▼ OEM Reference  
 EZ 2097-G1  
 FL 1204-027  
 HY 3142096  
 YT 220042096



**Part Number - 3C0006-R**  
**Curtis PMC Control**  
 ▼ OEM Reference  
 CU 4110440  
 FL 1207A-4119  
 HY 3182195  
 YT 150107179



**Part Number - 3C0018-R**  
**Curtis PMC Control**  
 ▼ OEM Reference  
 BR 27732-068  
 FL 1205-111  
 HY 3026561  
 YT 150022580  
 YT 220012004



**Part Number - 3C0007-R**  
**Curtis PMC Control**  
 ▼ OEM Reference  
 FL 1243C-4278  
 HY 1674663  
 RA 312668-001  
 RA 939-353-059  
 YT 52437009



**Part Number - 3C0002-R**  
**Curtis SX Control**  
 ▼ OEM Reference  
 FL 1244-4467  
 HY 3183244  
 RA 1-187-094/005  
 TY 00590-45652-71  
 YT 150114996



Part Number - 3C0004-R

**Curtis SX Control**

▼ OEM Reference  
 FL 1244-4424  
 HY 3174204  
 RA 1-187-094/003  
 YT 150022698  
 YT 220174204



Part Number - 3C0025-R

**Curtis SX Control**

▼ OEM Reference  
 FL 1242-4204  
 HY 3144453  
 PM 305878-000  
 YT 150022689



Part Number - 3C0026-R

**24V 300A Combi Semi Control-R**

▼ OEM Reference  
 FL FC2364  
 YT 524302946



Part Number - 3C0015-R

**1204X-4215 Curtis PMC Control-R**

▼ OEM Reference  
 FL 1204X-4215  
 RA 1-187-070

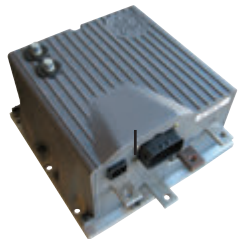

Part Number - 3C0022-R

**Regen SX Control**

▼ OEM Reference  
 CL 7006590  
 GE IC3645SR3R4U4N2  
 GE IC3645SR4U404N2  
 HY 3172279  
 YT 150022014  
 YT 580011153



Part Number - 3C0023-R

**Regen SX Control**

▼ OEM Reference  
 FL GEIC3645SR4W606N6  
 FL IC3645SR4W606N6  
 GE IC3645SR4W606N6  
 HY 1459800  
 HY 3177464  
 YT 150022016  
 YT 580007805



Part Number - 3C0028-R

**Controller Drive**

▼ OEM Reference  
 RA 312668-002  
 TY 00590-43460-71



Part Number - 370302-R

**Card Interface Single-R**

▼ OEM Reference  
 HY 1498101  
 HY 4016755  
 HY 4098569  
 YT 582006562  
 YT 582006562-R  
 YT 550093082



Part Number - 3C0012-R

**EV100 ZX Traction Card-R**

▼ OEM Reference  
 FL IC3645LXCD12H  
 GE IC3645LXCD1ZH  
 HY 3039525  
 HY 1397304  
 HY 1459419  
 YH 3039525  
 YH 3126503  
 YH 150021994  
 YT 220021426  
 YT 580006862



Part Number - 3C0013-R

**Easi Reach Power Card-R**

▼ OEM Reference  
 FL 154-012-429/103  
 HY 3178786  
 RA 154-012-429/103  
 RA 154-012-429/104  
 RA 154-012-430/004  
 RA 154-012-430/006  
 RA 154-012-430/007  
 YT 150050137



Part Number - 3C0014-R

**Easi Reach Coil Driver-R**

▼ OEM Reference  
 FL 828-004-206/003  
 HY 3178790  
 RA 828-004-206/003  
 RA 828-004-207/001  
 YT 150050141



Part Number - 370522

**Card Assembly - Circuit**

▼ OEM Reference  
 BT 1098272/001  
 PM 1098272/001  
 RA 1098272/001

## Cards



Part Number - 3C0016-R

### 24V MPB SX Zapi Control-R

▼ OEM Reference  
 FL 66-FC2086A  
 HY 2045951  
 YT 585098300



Part Number - 3C0027-R

### Control Card

▼ OEM Reference  
 GE IC3645SE68300GN1  
 GN 1263633



Part Number - 3C0029-R

### Zapi Control

▼ OEM Reference  
 FL 66-FC21250A  
 HY 2055599  
 YT 524169972



Part Number- 380030-234

### Control Module Assembly

▼ OEM Reference  
 CT 91E20-21500  
 MB 91E20-21500  
 NI 23710-GY31B



Part Number - 3C0032-R

### Zapi Control

▼ OEM Reference  
 BR 29310-FS120  
 FL 66-FC2254-120



Part Number - 380030-235

### Control Module Assembly

▼ OEM Reference  
 CT 91E20-01500  
 MB 91E20-01500  
 NI 23710-GY360



Part Number - 380030-230

### Controller

▼ OEM Reference  
 YT 582024006



Part Number - 380030-236

### Control Module Assembly

▼ OEM Reference  
 CT 93G20-00300  
 MB 93G20-00300  
 NI 23710-GY470

## DC/DC Converters



Part Number - 110979

- Operates 12V
- UL recognized
- Input voltage range: 18v minimum, 55v maximum
- Output current: 5 amp
- Not suitable for solid state electronics



Part Number - 370308

- 36/48v to 12 v
- Output power 300 W

▼ OEM Reference  
 HY 2066643

**Note:** Connector Kit - P.N. 370308-001, includes 4 way housing and female crimp terminals, 10-12 awg.



Part Number - 128652

- Operates 12V
- UL recognized
- Input voltage range: 36v minimum, 48v maximum
- Output current: 21-23 amps
- Input over and under voltage protection
- Input polarity protection
- Input spike protection
- Output short circuit protection
- Thermal protection
- Suitable for all electronics

#### Replacement Parts:

Input fuse: 094362-002  
 Output fuse: 062765-001

⚠ **WARNING:** Cancer and reproductive harm - [www.P65Warnings.ca.gov](http://www.P65Warnings.ca.gov)

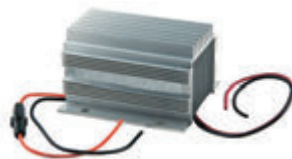

Part Number - 398000-156

- 18-50VDC to 13VDC, 10A

▼ OEM Reference  
 HY 3039168  
 TY 00591-21147-81



Part Number - 079549

**Solenoid**

12 Volt, Curved Bracket,  
Heavy Duty Intermittent

▼ OEM Reference

|               |               |                   |
|---------------|---------------|-------------------|
| AC 22226-02   | HY 3002952    | RA 308202-000     |
| AC 4614761    | HY 3003159    | RA 590-011        |
| AC 4814761    | HY 3007041    | RA 590-111        |
| AC 4905994    | HY 3013430    | RA 850-103-154    |
| AC 4912911    | HY 3052337    | RA 939-339        |
| AC 74912911   | HY 3053657    | SC 33-02018       |
| AC OP03001514 | HY 3056864    | SC 41-25015       |
| AT 3324       | HY 3131991    | TC 22226-02       |
| AT 3325       | HY 3132337    | TC A11467         |
| BC 1013609CC  | HY 3139728    | TC CK896553       |
| BJ 20417      | HY A130188C   | TC P-20142        |
| BJ 20419      | HY A130188O   | TC P-2226-2       |
| BJ 2833       | HY A26078     | TY 00591-04797-81 |
| BK 12MP2212   | JL 2222602    | TY 00591-06511-81 |
| BK 12MP2212V  | JL 2222602PM  | TY 00591-32096-81 |
| BK 130785     | KM 90007211   | TY 00591-32097-81 |
| BK 988628     | KM C903510    | TY 00591-32100-81 |
| BK 993971     | KO 22226-02   | TY 00591-32101-81 |
| BK EP2112EE   | KO 22226-04   | TY 00591-32107-81 |
| BK EP21EX     | KO 4614761    | TY 00591-41439-81 |
| BK LN993971   | KO 4814761    | TY 00591-41440-81 |
| BO 390107712  | KO 4905994    | TY 00591-51891-81 |
| BR 11467-000  | KO 4912911    | TY 00591-51893-81 |
| BR 988628     | KO 8730425    | TY 00591-51895-81 |
| BR A11467     | KO 8735533    | TY 00591-53292-81 |
| BR CK896553   | KO 8736471    | TY 00591-57386-81 |
| BR CK912975   | KO OP03001512 | YT 015926300      |
| BT 20142-00   | KO OP03001514 | YT 030121700      |
| BT 22226-02   | LI 12MP2212   | YT 076504100A     |
| BT 22226-04   | LI 130785     | YT 0957643BA      |
| BT 308202-000 | LI 159802     | YT 0957643CA      |
| CL 1628551    | LI 988628     | YT 0957643CK      |
| CL 7003907    | LI 993971     | YT 150034000      |
| CL 7003909    | LI EP2112EE   | YT 220012834      |
| CL 893329     | MB 0302266    | YT 220023937      |
| CL 896553     | MB 0971600    | YT 220031728      |
| CL 912975     | MB 0973212    | YT 220035664      |
| CL 999634     | MB 0973708    | YT 220051072      |
| CL LN993971   | MB 302266     | YT 220051922      |
| CT 0302266    | MB 971600     | YT 220051923      |
| CT 0971600    | MB 973212     | YT 500203300      |
| CT 0973212    | MB 973708     | YT 500218300      |
| CT 0973708    | MB A000012044 | YT 501270301      |
| CT 302266     | ME 80374      | YT 501270304      |
| CT 971600     | NI CK896553   | YT 502265300      |
| CT 973212     | NI CK912975   | YT 504903802      |
| CT 973708     | PM 20142-00   | YT 510489802      |
| CT A000012044 | PM 22226-02   | YT 511289100      |
| CU 840769     | PM 22226-04   | YT 511489802      |
| EZ 840769     | PM 308202-000 | YT 5188188-34     |
| HM 3249       | PM P-20142    | YT 518818834      |
| HY 1198733    | PM P-22226-2  | YT 620020100      |
| HY 1322354    | RA 22226-02   |                   |
| HY 238761     | RA 22226-04   |                   |

⚠ WARNING: Cancer - [www.P65Warnings.ca.gov](http://www.P65Warnings.ca.gov)



Part Number - 084343

**Solenoid**

24 Volt, Curved Bracket,  
Heavy Duty Intermittent

▼ OEM Reference

|                |                 |                   |
|----------------|-----------------|-------------------|
| AC 4814762     | DS P100-0024    | MB A000000297     |
| AC 4913135     | DW 26099        | MB W205010471     |
| AC 74814762    | EZ 30807G1      | ME SM7-15         |
| AC OP03001127  | HM 3179         | MJ A3130          |
| AC OP03001513  | HM 3250         | MJ A3131          |
| AC OP03001513A | HY 1307121      | MJ A3135          |
| BJ 20422       | HY 1322444      | MJ A3139          |
| BJ 20715       | HY 238754       | MT 500873341      |
| BJ 2606        | HY 294814       | MT 77800437       |
| BJ 900756      | HY 3001410      | MT 77800506       |
| BK 12MP2224    | HY 3002398      | NI 13593-000      |
| BK 12MP2224V   | HY 3002600      | NI CK1613990      |
| BK 130803      | HY 3014061      | NI CK907270       |
| BK 153947      | HY 3027557      | NI CK919974       |
| BK 989897      | HY 3038466      | PM 134615         |
| BK 992777      | HY 3053898      | PM 22201          |
| BK 993972      | HY 3054165      | PM 22226-01       |
| BK EP21-24     | HY 3054368      | PM 308203-000     |
| BK EP21-24V    | HY 3125730      | PM INSOL-401      |
| BK EP2124HYDY  | HY 326994       | RA 134615         |
| BK EP2124REG   | HY 360610       | RA 22226-01       |
| BK LN993972    | JU 14157280     | RA 308203-000     |
| BK SAS4401     | JU 14462820     | RA 560-209-09     |
| BR 11469-000   | JU 50010973     | RA 939-016        |
| BR 13593-000   | JU 77800437     | RA DS226279       |
| BR 28700-050   | JU 77800506     | RA INSOL-401      |
| BR A11469      | KO 22226-01     | RA J77-800-437    |
| BR A13593      | KO 308203-000   | SC 18-31227       |
| BR CK1613990   | KO 4814762      | SC 33-02016       |
| BR CK907270    | KO 4913135      | SC 41-28018       |
| BR CK919974    | KO 4960349      | TC CK1613990      |
| BR PM22226-01  | KO 4960776      | TC CK907270       |
| BT 134615      | KO 8730320      | TY 00590-04565-71 |
| BT 22201       | KO 8733937      | TY 00591-02112-01 |
| BT 22226-01    | KO 8733937A     | TY 00591-02113-81 |
| BT 22231       | KO 8736077      | TY 00591-03630-81 |
| BT 308203-000  | KO OP03001127   | TY 00591-06514-81 |
| BT INSOL-401   | KO OP03001513   | TY 00591-21048-81 |
| BT P-22226-1   | KO OP03001513A  | TY 00591-21049-81 |
| BT P22226      | LI 12MP2224     | TY 00591-32117-81 |
| CL 1613990     | LI 12MP2224HYDY | TY 00591-32119-81 |
| CL 337670      | LI 12MP2224V    | TY 00591-41450-81 |
| CL 773124      | LI 130803       | TY 00591-51900-81 |
| CL 773296      | LI 153947       | TY 00591-51902-81 |
| CL 898796      | LI 989897       | TY 00591-76238-81 |
| CL 906283      | LI 992777       | YT 220000838      |
| CL 907270      | LI 993972       | YT 220006542      |
| CL 919974      | LI EP2124       | YT 220012672      |
| CL 994686      | LI EP2124HYDY   | YT 220014866      |
| CL 999639      | LI EP2124REG    | YT 220020167      |
| CT 1075426     | LI LN993972     | YT 220021112      |
| CT 1176440     | LI SAS4401      | YT 220035697      |
| CT 213272      | MB 0973650      | YT 220054095      |
| CT 215063      | MB 1075426      | YT 252806500      |
| CT 77800437    | MB 1176440      | YT 4015930B       |
| CT 973650      | MB 213272       | YT 518818835      |
| CT A000000297  | MB 215063       | YT 57958800       |
| CT W205010471  | MB 77800437     | YT 580031193      |
| CU 30807G1     | MB 973650       |                   |

⚠ WARNING: Cancer - [www.P65Warnings.ca.gov](http://www.P65Warnings.ca.gov)



## Solenoids



Part Number - 370327

### Solenoid

▼ OEM Reference

BR PM22226-05 HY 800140689 RA 22226-05  
BT 22226-05 PM 22226-05 RA 851-200-443

▲ WARNING: Cancer - [www.P65Warnings.ca.gov](http://www.P65Warnings.ca.gov)



Part Number - 370197

### Solenoid

24V, Straight Bracket

▼ OEM Reference

TY 00590-43462-71



Part Number - 077157-002

### Solenoid

24V, Flat Bracket, Continuous Duty

▼ OEM Reference

AC 22226-3 DR 1115636 PM 22226-03  
BT 132160 KO 22226-03 RA 22226-03  
BT 22226-03 PM 132160 RA 590118

▲ WARNING: Cancer - [www.P65Warnings.ca.gov](http://www.P65Warnings.ca.gov)



Part Number - 370322

### Solenoid

24V-WR

▼ OEM Reference

AC OP03001086 KO 23452-01 NI PM2345201  
BR PM23452-01 KO 8730162 PM 23452-01  
BT 23452-01 KO 8734702 RA 23452-01  
CL 919743 KO OP03001086



Part Number - 077157-001

### Solenoid

36 Volt, Flat Bracket with Insulator, Continuous Duty

▼ OEM Reference

CL 1636581 PL 15-261 TY 00591-51898-81  
CT 972885-ORG PL 15-334 TY 00591-51899-81  
HY 260574 PL 15-376 WH 70-120224-5  
HY 260575 PL SAS-4301 WH 71-120224-5B1-ORG  
HY 260576 PL SAS-4303 YT 074298100  
HY 278111-ORG PL SAS-5303-A YT 220003303  
HY 3030124-ORG PL SAS-5303-B YT 220013134  
HY 3053003 PL SAS-5303A YT 501270306  
HY 327058 PL SAS-5303B YT 580000235  
MB 972885-ORG TY 00591-06513-81-ORG YT 742981  
NI CK1636581-ORG TY 00591-32120-81  
PL 15-242 TY 00591-32126-81

▲ WARNING: Cancer - [www.P65Warnings.ca.gov](http://www.P65Warnings.ca.gov)



Part Number - 370314

### Solenoid

24V

▼ OEM Reference

BT 560-213/06  
PM 560-213/06  
RA 560-213/06

## Battery Capacity Indicators & Hour Meters

Continued ▶

| Part Number | Voltage | Body Diameter  | Overall Length | Lens  | Display               |
|-------------|---------|----------------|----------------|-------|-----------------------|
| 130997      | 12-24   | 66.7mm (2.63") | 52mm (2.05")   | Glass | Hour Meter            |
| 824819      | 24-48   | 69mm (2.73")   | 52mm (2.05")   |       | 99999.9 LCD BDI - LED |



Combines in one instrument a completely solid state battery discharge indicator, an LCD hour meter and lift lockout, housed in a 52 mm case. Indicates state of charge in 10 bar LED display. Void of moving parts, this instrument is exceptionally reliable even in severe operating environments. Suitable for all electric vehicles. Mounting hardware included.

Note: All round gauges utilize an industry standard mounting hole.



| Part Number | Voltage | Lens | Display         |
|-------------|---------|------|-----------------|
| 370092      | 24-36   |      | BDI, Hour Meter |

▼ OEM Reference

BT 301445-000 HY 864794 RA 939-122  
CL 448375 KO 301445-00 TY 00590-00528-71  
CL 7000601 KO 301445-00 TY 00590-00609-71  
CL 913739 MB 1009518 TY 00590-00610-71  
CL 917966 MB 1100728 TY 00590-03794-81  
CL 919749 PM 23268-01 TY 00590-09015-81  
CT NAO17474 PM 301445-00 TY 00590-42119-71  
CT 1009518 RA DS226823 TY 00591-03794-81  
CT 1100728 RA DS226824 TY 00591-09015-81  
HY 0864794 RA 850-139-183-004 YT 220029245  
HY 1361313 RA 870-231-002 YT 220037690  
HY 2046257 RA 870-231-003 YT 524148929  
HY 3057690 RA 870-248 YT 752060402  
HY 3137245 RA 870-256 YT 752626302



| Part Number | Voltage | Lens | Display         |
|-------------|---------|------|-----------------|
| 370005      | 12-24   |      | BDI, Hour Meter |

▼ OEM Reference

HY 2046546  
YT 580026708

## Battery Capacity Indicators & Hour Meters



| Part Number | Voltage  | Vendor Number |
|-------------|----------|---------------|
| 134527      | 24       | Curtis 933    |
| 134528      | 36       | Curtis 933    |
| 134529      | 24-36-48 | Curtis 933    |

Controller with lift lockout and adjustable reset and discharge settings. It features a rugged aluminum controller for reliable operation, even in the most severe conditions. It prolongs battery life and protects vehicle components from the effects of deep discharge in material handling and other battery powered vehicles. Use in conjunction with part number 153830.

| Part Number | Voltage | Lens  | Display              |
|-------------|---------|-------|----------------------|
| 124819      | 36      | Lexan | BDI, Hour Meter, LCD |



| Overall Length   | Body Diameter   |
|------------------|-----------------|
| 91.69 mm (3.61") | 62.23mm (2.45") |

Displays various system parameters, such as battery state of charge, operation hours, event code, and 10K light. Used on FC4 & SC4. Battery charge light, when on, shows the percent of charge left in the battery. It will flash to warn you of a low battery charge. When key is turned off, the display will show total hours of truck operation.



| Part No. | Voltage | Lens          | Display |
|----------|---------|---------------|---------|
| 153830   | 24-48   | Polycarbonate | LED     |

| Overall Length | Body Diameter  |
|----------------|----------------|
| 54mm (2.13")   | 58.5mm (2.30") |

Discharge meter, use in conjunction with 134527, 134528 and 134529 battery interrupts. Hardware to mount included.



| Part Number | Voltage | Hardware      |
|-------------|---------|---------------|
| 113773-001  | 12-48   | Bracket/Nuts  |
| 113773-003  | 12-48   | Mounting Ring |

| Overall Length | Body Diameter | Display |
|----------------|---------------|---------|
| 38mm (1.48")   | 52mm (2.05")  | 9999.9  |

Kit (P.N. 114254) includes 113773-001 and red/white lead.

Highly reliable solid state hour meter that offers an unprecedented combination of patented technology, performance, reliability and value. It has a provision for continuous display. Has LCD display. DC only. Mounting hardware included. Signal input positive.

| Part Number | Voltage | Lens  | Display |
|-------------|---------|-------|---------|
| 115083      | 12-24   | Lexan | LED     |
| 106288      | 24-36   |       | LED     |
| 126238-002* | 24-36   |       | LED     |

| Overall Length | Body Diameter |
|----------------|---------------|
| 64mm (2.53")   | 52mm (2.05")  |

Dual voltage, easy to install "fuel" gage. Reliable, accurate and easy to read display of battery state-of-charge. For lead acid battery-powered vehicles that require a display function only. Mounting hardware included.

\*Note: Maintenance-free batteries.



| Part Number | Voltage | Display |
|-------------|---------|---------|
| 113773-006  | 12-48   | 9999.9  |

| Overall Length | Body Diameter |
|----------------|---------------|
| 54mm (2.12")   | 52mm (2.05")  |

Highly reliable solid state hour meter that offers an unprecedented combination of patented technology, performance, reliability and value. It has a provision for continuous display. Has LCD display. DC only. Includes hardware to mount. Signal input negative.

| Part Number | Voltage | Type     | Lens  | Display                                  |
|-------------|---------|----------|-------|--|
| 130600-001  | 12      | Standard | Glass | Hour Meter 8 alpha-numeric, LCD, BDI-LED |
| 130600-002  | 12      | Freezer  | Glass |  |

| Overall Length | Body Diameter |
|----------------|---------------|
| 64mm (2.53")   | 52mm (2.05")  |

Displays various system parameters, such as battery state-of-charge, operation hours or maintenance status from a motor controller or other serial communication source. Ideal for pallet trucks, walkies, stackers and order pickers as well as other equipment with a need to display data using a dedicated unidirectional asynchronous serial signal. Mounting hardware included.



| Part Number | Voltage | Display |
|-------------|---------|---------|
| 113773-004  | 12-48   | 9999.9  |

| Overall Length | Body Diameter                 |
|----------------|-------------------------------|
| 34mm (1.318")  | 31mm x 54mm (1.224" x 2.098") |

Highly reliable solid state hour meter that offers an unprecedented combination of patented technology, performance, reliability and value. It has a provision for continuous display. Has LCD display. DC only. Utilizes flat quick-connect terminal tabs with hole.

| Part Number | Voltage | Lens  | Display              |
|-------------|---------|-------|----------------------|
| 129042      | 36-48   | Lexan | BDI, Hour Meter, LCD |

| Overall Length   | Body Diameter   |
|------------------|-----------------|
| 91.69 mm (3.61") | 62.23mm (2.45") |

Displays various system parameters, such as battery state of charge, operation hours, event code, and 10K light. Used on FC4. Battery charge light, when on, shows the percent of charge left in the battery. It will flash to warn you of a low battery charge. When key is turned off, the display will show total hours of truck operation. Used on trucks with two controllers.



**Frame and Undercarriage -  
LW & Lift Linkage**



○ Current parts available from Crown

**1 - Load Wheel Assembly, High Load (95A)**  
P.N. 310245-302-88  
▼ OEM Reference  
HY 2046051-A  
HY 2046054-A  
HY 2046054-A1  
HY 524250486  
YT 582010234

**2 - Load Wheel**  
P.N. 310245-xxx  
▼ OEM Reference  
HY 2046054  
YT 524148750

**3 - Wheel Bearing**  
P.N. 311000-006  
▼ OEM Reference  
HY 2046055  
YT 524148751

**4 - Bushing/String Guard**  
P.N. 370142  
▼ OEM Reference  
HY 2046056  
YT 524148752

**5 - Fork Riser**  
P.N. 370010  
▼ OEM Reference  
HY 2046053  
YT 524148749  
YT 524250478

**6 - Exit Roller**  
P.N. 370017  
▼ OEM Reference  
HY 2307475  
HY 3000693  
HY 3003759  
HY 3006938  
YT 64857600  
YT 220053022  
YT 751791300

**7 - Grease Fitting**  
P.N. 100779  
▼ OEM Reference  
HY 3050200  
HY 3050288  
YT 22783500  
YT 31459100  
YT 220001019  
YT 220016295  
YT 503828100  
YT 524148462

**8 - Load Wheel Axle**  
P.N. 370009  
▼ OEM Reference  
HY 2046057  
YT 524148753

**9 - Pivot Pin**  
P.N. 370107  
▼ OEM Reference  
HY 2039119  
HY 2040200  
HY 2046263  
YT 524140839  
YT 524141201  
YT 585096306

**10 - Pivot Pin**  
P.N. 370001  
▼ OEM Reference  
HY 2046264  
HY 2072211  
YT 524221067  
YT 585096307

**11 - Spiral Pin**  
P.N. 060000-068  
▼ OEM Reference  
HY 2046059  
HY 2307242  
HY 3014372  
YT 220008856  
YT 220023535  
YT 220037894  
YT 220050279  
YT 501985905  
YT 524148755

**12 - Pin Coiled**  
P.N. 370262  
▼ OEM Reference  
HY 2050087  
HY 2050088  
YT 585096801  
YT 585096802

**13 - Grease Fitting**  
P.N. 370120  
▼ OEM Reference  
HY 2025757  
HY 2040833  
HY 2305757  
HY 2790462  
HY 3041021  
HY 3131315  
YT 220005338  
YT 220022915  
YT 273033400  
YT 449076005

**14 - Push Rod**  
P.N. 370016  
▼ OEM Reference  
HY 2046286  
HY 2085540  
YT 585094505

**15 - Pivot Pin**  
P.N. 370045  
▼ OEM Reference  
HY 2046260  
HY 2046262  
YT 524221064  
YT 585096303  
YT 585096305

**16 - Pivot Pin**  
P.N. 370044  
▼ OEM Reference  
HY 2046259  
YT 585096302

**17 - Pin Coiled**  
P.N. 370262  
▼ OEM Reference  
HY 302467  
HY 2050087  
HY 2050088  
YT 585096801  
YT 585096802

**19 - Lower Rear Link RH**  
P.N. 370036  
▼ OEM Reference  
HY 2050086  
YT 524144864

**20 - Lower Rear Link LH**  
P.N. 370037  
▼ OEM Reference  
HY 2050085  
YT 524144865

**21 - Riser, Wheel and Axle Assembly**  
P.N. 370013  
▼ OEM Reference  
HY 2043251  
HY 4018767  
YT 524143966  
YT 524243135  
YT 524328746  
YT 582007340

**22 - Load Wheel and Axle Assembly**  
P.N. 360038-176  
▼ OEM Reference  
HY 800127595  
YT 150118854  
YT 800127595

## Frame and Undercarriage

### 1 - Poly Load Wheel

P.N. 310185-302

▼ OEM Reference  
HY 3005911

### 2 - Bearing

P.N. 311000-004

▼ OEM Reference  
HY 124624

### 4 - Poly Load Wheel Assembly, w/Bearings & Washers, 95-A

P.N. 360038-122

▼ OEM Reference  
HY 3005911-A  
YT 065269600A  
YT 065269601A

### 5 - Load Wheel Axle w/Lube Fitting

P.N. 370046

▼ OEM Reference  
HY 3005736

### 6 - Lube Fitting

P.N. 370292

▼ OEM Reference  
HY 13957

### 7 - Roll Pin

P.N. 060000-068

▼ OEM Reference  
HY 2307242

### 8 - Pivot Pin

P.N. 370027

▼ OEM Reference  
HY 2309397

### 10 - Fork Riser w/ Lube Fitting

P.N. 370050

▼ OEM Reference  
HY 2302730

### 15 - Lube Fitting

P.N. 100779

▼ OEM Reference  
HY 16041

### 21 - Link

P.N. 370020

▼ OEM Reference  
HY 2307680

### 26 - Hex Bolt

P.N. 060016-004

▼ OEM Reference  
HY 18497

### 9 - Roll Pin

P.N. 060000-024

▼ OEM Reference  
HY 2307086

### 11 - Riser Assembly w/Load Wheel & Axle

P.N. 360038-131

▼ OEM Reference  
HY 2302730-A  
YT 065771100

### 16 - Push Rod, 48" Forks

P.N. 370022

▼ OEM Reference  
HY 2308822

### 22 - Retaining Ring

P.N. 060009-005

▼ OEM Reference  
HY 58903

### 27 - Roll Pin

P.N. 060000-104

▼ OEM Reference  
HY 19913

### 12 - Exit Roller

P.N. 370017

▼ OEM Reference  
HY 2307475

### 17 - Spacer

P.N. 360038-264

▼ OEM Reference  
HY 2311881  
YT 751776300

### 23 - Nut

P.N. 060021-009

▼ OEM Reference  
HY 15001  
HY 15055

### 28 - Pin

P.N. 370023

▼ OEM Reference  
HY 2311661

### 13 - Link Pin

P.N. 370018

▼ OEM Reference  
HY 3006808

### 19 - Pin, Push Rod

P.N. 370049

▼ OEM Reference  
HY 3008398

### 24 - Lockwasher

P.N. 090875

▼ OEM Reference  
HY 15155

### 32 - Bellcrank Pin, 27" Wide Forks

P.N. 370032

▼ OEM Reference  
HY 2309006

### 14 - Roll Pin

P.N. 060000-024

▼ OEM Reference  
HY 2307086

### 20 - Pin

P.N. 370021

▼ OEM Reference  
HY 2304484

### 25 - Pin

P.N. 370047

▼ OEM Reference  
HY 2305824

### 34 - Nut

P.N. 060021-009

▼ OEM Reference  
HY 15001  
HY 15055

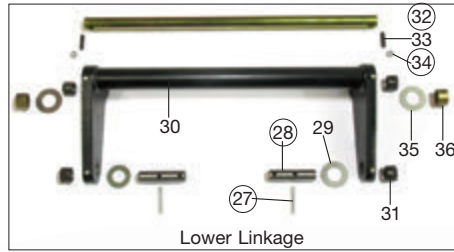

Lower Linkage

○ Current parts available from Crown

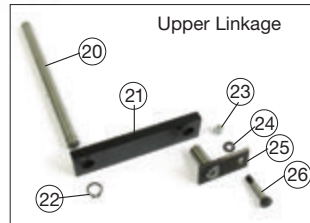
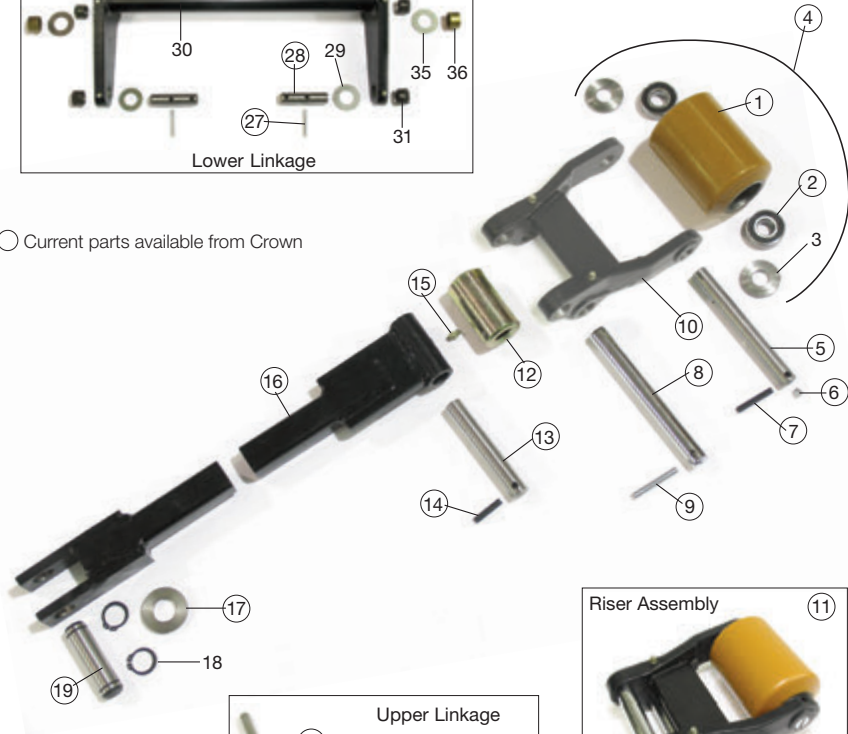

Upper Linkage



Riser Assembly

**Frame and Undercarriage**

**2 - Washer**

P.N. 370501-070

▼ OEM Reference  
RA 5-018-006

**3 - Washer - Lock Kit**

P.N. 370501-055

▼ OEM Reference  
RA 5-019-006

**4 - Shaft**

P.N. 351096-200

▼ OEM Reference  
RA 1026383

**5 - Roller - Pallet**

P.N. 370615

▼ OEM Reference  
RA 360-067-004

**6 - Pivot Shaft**

P.N. 360038-267\*

▼ OEM Reference  
RA 1026637\*

**7 - Block - Pivot LH**

P.N. 370501-302\*

P.N. 370501-294\*\*

▼ OEM Reference  
RA 1026378-001\*  
RA 1026378-002\*\*

**8 - Screw**

P.N. 360038-207

▼ OEM Reference  
RA 714-145

**9 - Spacer, Tube**

P.N. 370180\*

▼ OEM Reference  
RA 1045247-001\*

**10 - Block - Pivot RH**

P.N. 370501-303\*

P.N. 370501-299\*\*

▼ OEM Reference  
RA 1026377-001\*  
RA 1026377-002\*\*

**11 - Grease Fitting**

P.N. 370292

▼ OEM Reference  
RA 840-033

**12 - Grease Fitting**

P.N. 370159

▼ OEM Reference  
RA 840-018

**18 - Fork Riser**

P.N. 370177\*

P.N. 370178\*\*

▼ OEM Reference  
RA 1025351-002\*  
RA 1025353-002\*\*

**19 - Bushing**

P.N. 370526\*

P.N. 065117-001\*\*

▼ OEM Reference  
RA 1025348-007\*  
RA 1025349-007\*\*

**20 - Spacer**

P.N. 380700-014

▼ OEM Reference  
RA 771-033

**21 - Load Wheel Axle, Single**

P.N. 370122

▼ OEM Reference  
RA 850-135-634

**22 - Load Wheel**

P.N. 310178-xxx

▼ OEM Reference  
RA 632-069

**23 - Bearing Non-Shielded**

P.N. 042022 ⚠

▼ OEM Reference  
RA 441-015

**24 - Bearing Shielded**

P.N. 311000-006

▼ OEM Reference  
RA 441-127

**25 - Spiral Pin**

P.N. 060000-081

▼ OEM Reference  
RA 810-747

**26 - Shaft - Rear Link**

P.N. 370501-283\*

P.N. 370598\*\*

▼ OEM Reference  
RA 1050893-001\*  
RA 1050893-002\*\*

**27 - Retaining Ring**

P.N. 060009-037

▼ OEM Reference  
RA 810-131  
RA 810-132

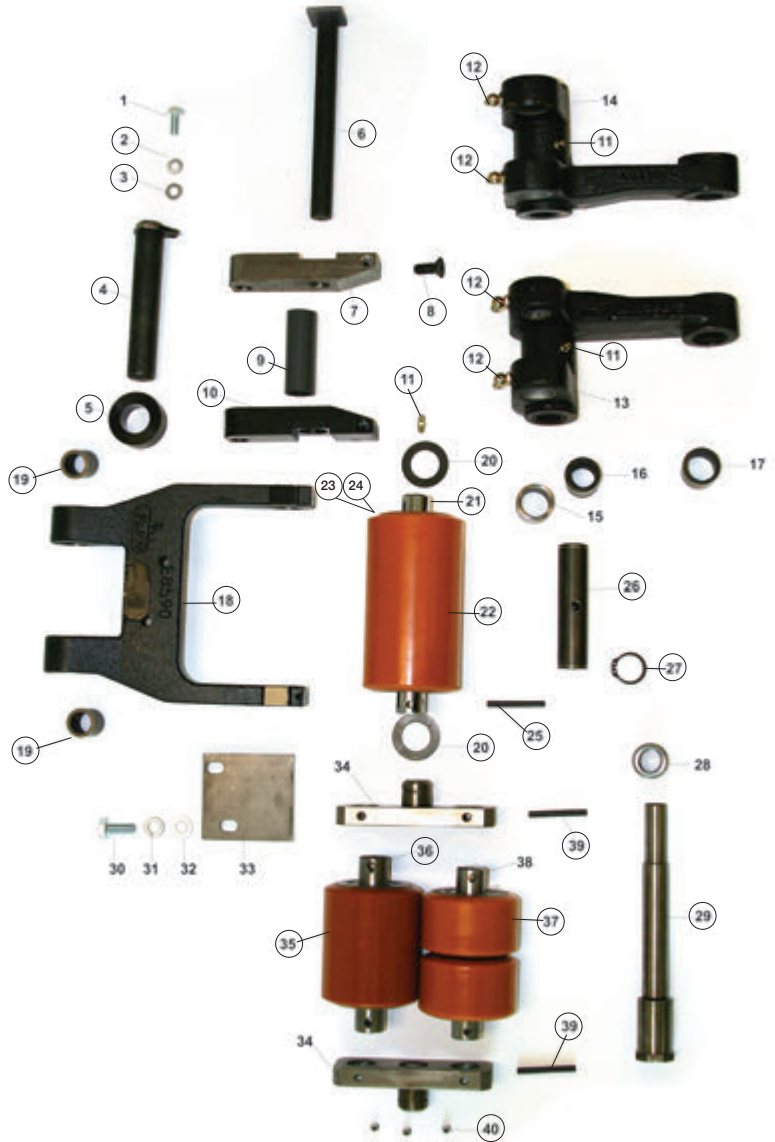

○ Current parts available from Crown

**29 - Pin, Eccentric**

P.N. 370519\*

▼ OEM Reference  
RA 1044707\*

**35 - Load Wheel, Tandem**

P.N. 310180-xxx

▼ OEM Reference  
RA 632-071

**36 - Tandem LW Axle**

P.N. 360038-160

▼ OEM Reference  
RA 850-137-070

**37 - Load Wheel, Tandem Split**

P.N. 310125-xxx

▼ OEM Reference  
RA 632-076

**39 - Spiral Pin**

P.N. 370066

▼ OEM Reference  
RA 810-762

**40 - Grease Fitting**

P.N. 370121

▼ OEM Reference  
RA 841-111

\*6,000 lbs. Capacity  
\*\*8,000 lbs. Capacity

⚠ WARNING: Cancer - www.P65Warnings.ca.gov



Part Number - 370013

**Riser Wheel Axle Assembly**

▼ OEM Reference  
HY 2043251  
YT 524143966



Part Number - 370211

**Fork Riser**

▼ OEM Reference  
JU 51076281



Part Number - 370050

**Fork Riser**

▼ OEM Reference

|            |                   |              |
|------------|-------------------|--------------|
| BK 992626  | HY 3011678        | YT 64856600  |
| BK 992627  | TY 00591-30852-81 | YT 65054700  |
| HY 2302730 | TY 00591-52307-81 | YT 643182400 |



Part Number - 370036

**Lower Link (Right)**

▼ OEM Reference  
HY 2050086  
YT 524144864

Part Number - 370037

**Lower Link (Left)**

▼ OEM Reference  
HY 2050085  
YT 524144865



Part Number - 370010

**Fork Riser**

▼ OEM Reference  
HY 2046053  
HY 2081792  
YT 524148749  
YT 524250478



Part Number - 370427

**Link-FR Lower Assembly**

▼ OEM Reference  
BR 32606-014 NI 48503-FS000  
BR 48503-FS000 TY 00591-38800-81  
NI 32606-014 TY 00591-58635-81



Part Number - 370176

**Fork Riser**

▼ OEM Reference  
PM 312638-000  
RA 939-352-256  
TY 00590-43543-71

Part Number - 370016

**Push Rod 48 in. Forks**

▼ OEM Reference  
HY 2046286  
YT 585094505



Part Number - 370177\*

**Fork Riser**

▼ OEM Reference  
RA 1025351-002  
TY 00590-46291-71

Part Number - 370022

**Push Rod 48 in. Forks**

▼ OEM Reference

|            |                   |              |
|------------|-------------------|--------------|
| BK 992640  | TY 00591-30860-81 | YT 502447503 |
| CL 7001866 | YT 501771303      | YT 502448503 |
| HY 2308822 |                   |              |



Part Number - 370178\*\*

**Fork Riser**

▼ OEM Reference  
RA 1025353-002  
TY 00590-46288-71

\*6,000 lbs. Capacity  
\*\*8,000 lbs. Capacity



Part Number - 370009

**Load Wheel Axle-Steel Chromed**

▼ OEM Reference  
HY 2046057  
YT 524148753



Part Number - 370260

**Fork Riser**

▼ OEM Reference  
LP 763-1206  
RA 1025355



Part Number - 370046

**Load Wheel Axle-Steel Plain**

▼ OEM Reference

|            |                   |              |
|------------|-------------------|--------------|
| BK 992629  | HY 3005736        | YT 220037538 |
| CL 7001749 | TY 00591-30754-81 | YT 640374100 |
| CT 218051  | TY 00591-52316-81 | YT 641433100 |
| HY 2304088 | TY 00591-76717-81 |              |



Part Number - 370078

**Fork Riser**

▼ OEM Reference  
HY 2039904 YT 524141180  
HY 2058037 YT 524177337



**Part Number - 370189**  
**Roller Axle - Steel Plain**

▼ OEM Reference

|             |             |                   |
|-------------|-------------|-------------------|
| BK L1700000 | JU 3310058  | MB 71305310       |
| CT 27811190 | JU 3312263  | MT 3310058        |
| CT 33122630 | JU 33122630 | MT 38686          |
| CT 71305310 | JU 7130531  | RA 38686          |
| HP MU38686  | JU 71305310 | TY 00591-43128-81 |
| JU 2781065  | MB 27811190 | TY 00591-55629-81 |
| JU 27810650 | MB 33122630 |                   |



**Part Number - 370067**  
**Load Wheel Axle**

▼ OEM Reference

|                   |                   |              |
|-------------------|-------------------|--------------|
| CL 7002631        | TY 00591-58564-81 | YT 505617500 |
| TY 00591-38443-81 | TY 00591-76605-81 |              |



**Part Number - 370130**  
**Load Roller Axle-Steel Plain**

▼ OEM Reference

|             |           |                   |
|-------------|-----------|-------------------|
| BG 906-0013 | PM 47133  | RA 111257         |
| BT 47133    | PM 111257 | TY 00591-43227-81 |
| BT 111257   | RA 47133  | TY 00591-43588-81 |



**Part Number - 370167**  
**Axle Entry Roller**

▼ OEM Reference

|              |
|--------------|
| HY 2039255   |
| YT 524140913 |



**Part Number - 370095**  
**Load Wheel Axle**

▼ OEM Reference

|             |
|-------------|
| BK LN153450 |
| BK 153450   |



**Part Number - 370119**  
**Triple Axle**

▼ OEM Reference

|                    |
|--------------------|
| RA 850-135-634-3   |
| RA 850-135-634-3HL |



**Part Number - 370572**  
**Load Wheel Axle**

▼ OEM Reference

|               |
|---------------|
| RA 304619-002 |
| RA 304619-X01 |



**Part Number - 370192**  
**Wheel Axle Assembly**

▼ OEM Reference

|                |
|----------------|
| RA 623-010-297 |
|----------------|



**Part Number - 370229**  
**Load Wheel Axle**

▼ OEM Reference

|             |                |             |
|-------------|----------------|-------------|
| CT 51012680 | JU 51059718    | MB 51059718 |
| CT 51059718 | MB W2050-13546 |             |
| JU 51012680 | MB 51012680    |             |



**Part Number - 370270**  
**Caster Axle**

▼ OEM Reference

|                |
|----------------|
| RA 828-006-728 |
|----------------|



**Part Number - 370268**  
**Load Wheel Axle**

▼ OEM Reference

|                |
|----------------|
| RA 1014758-001 |
|----------------|



**Part Number - 370224**  
**Axle/Shaft**

▼ OEM Reference

|             |
|-------------|
| JU 33138390 |
|-------------|



**Part Number - 370269**  
**Load Wheel Axle**

▼ OEM Reference

|                |
|----------------|
| RA 1014758-002 |
|----------------|



**Part Number - 370232**  
**Shaft/Axle**

▼ OEM Reference

|                |
|----------------|
| CT 33138380    |
| JU 33138380    |
| MB W2050-10198 |
| MB 33138380    |



**Part Number - 370324**  
**Load Wheel Axle**

▼ OEM Reference

|               |              |               |
|---------------|--------------|---------------|
| AC 304619-000 | HY 800129393 | PM 304619-000 |
| BT 304619-000 | KO 8734677   | RA 304619-000 |



**Part Number - 370074**  
**Axle**

▼ OEM Reference

|              |
|--------------|
| HY 2045925   |
| YT 524148464 |



**Part Number - 370075**  
**Load Wheel Axle**

▼ OEM Reference

|            |              |              |
|------------|--------------|--------------|
| CL 7002781 | HY 2061914   | YT 524187950 |
| HY 2039868 | YT 524141151 | YT 524230699 |
| HY 2039869 | YT 524141153 |              |



**Part Number - 370741**  
**Stud Drive Axle Wheel**

▼ OEM Reference

|               |                   |              |
|---------------|-------------------|--------------|
| CL 7002828    | HY 3057473        | YT 220036432 |
| CT 549444     | MB 549444         | YT 220079286 |
| CT 4660-19030 | MB 4660-19030     | YT 520045496 |
| HY 110715     | TY 00591-38883-81 |              |
| HY 125743     | TY 00591-58325-81 |              |



**Part Number - 370122**  
**Axle**  
 ▼ OEM Reference

|            |                   |                   |
|------------|-------------------|-------------------|
| CL 7002767 | RA 850-135-305    | TY 00591-38729-81 |
| CT 1009733 | RA 850-135-634    | TY 00591-58588-81 |
| HY 3121689 | RA DS226867       | TY 220018798      |
| MB 1009733 | TY 00590-00020-71 |                   |



**Part Number - 370123**  
**Axle**  
 ▼ OEM Reference

|              |                    |                   |
|--------------|--------------------|-------------------|
| CL 7001987   | CT NA-013763       | TY 00591-30961-81 |
| CT 1055818   | MB NA-013763       | TY 220003938      |
| CT 1055827   | RA 623-010-110-002 |                   |
| CT NA012942B | RA 623-010-181-002 |                   |



**Part Number - 370138**  
**Axle**  
 ▼ OEM Reference

BR 40001-FS002



**Part Number - 370140**  
**Axle**  
 ▼ OEM Reference

|               |                   |                   |
|---------------|-------------------|-------------------|
| CL 7001873    | RA 812-000-106    | TY 00591-30868-81 |
| CT A000003155 | RA 812-001-261    | TY 00591-63154-81 |
| HY 3005844    | TY 00591-07615-81 | TY 220001768      |



**Part Number - 370155**  
**Axle**  
 ▼ OEM Reference

|            |                   |                   |
|------------|-------------------|-------------------|
| BK 986042  | CL 7001803        | TY 00591-30794-81 |
| BK PAL18   | CT 218049         | TY 00591-36969-81 |
| BK 138043  | HY 3005747        | TY 00591-52025-81 |
| BK 984297  | HY 3143583        | TY 00591-70791-81 |
| BK 986036  | SC 21-41323       | YT 220016551      |
| BK 986042  | SC 21-41520       | YT 220043583      |
| CL 7001797 | SC 41-27543       | YT 505340501      |
| CL 7001802 | TY 00591-30790-81 | YT 505340502      |



**Part Number - 370141**  
**Axle**  
 ▼ OEM Reference

RA 850-139-349



**Part Number - 370226**  
**Axle**  
 ▼ OEM Reference

JU 33138370



**Part Number - 370187**  
**Axle**  
 ▼ OEM Reference

|            |                   |              |
|------------|-------------------|--------------|
| CL 7001794 | MB A3448          | TY 501193100 |
| CT A3448   | TY 00591-36965-81 | TY 524163144 |
| HY 2309107 | TY 00591-60840-81 |              |
| HY 3005832 | TY 220035767      |              |



**Part Number - 370316**  
**Axle**  
 ▼ OEM Reference

YT 524150938



**Part Number - 370193**  
**Axle**  
 ▼ OEM Reference

|            |                   |              |
|------------|-------------------|--------------|
| HY 1450616 | HY 2013153        | YT 580000461 |
| HY 1450617 | TY 00591-74534-81 | YT 580000462 |
| HY 1493867 | YT 519433626      | YT 580024028 |



**Part Number - 370222**  
**Axle**  
 ▼ OEM Reference

|             |                |
|-------------|----------------|
| CT 51065679 | MB W205013572  |
| JU 51065679 | MB W2050-13572 |
| MB 51065679 |                |



**Part Number - 370283**  
**Axle - Corrosion Resistant**  
 ▼ OEM Reference

PM 313185-000  
 RA 939-353-127  
 TY 00590-43548-71



**Part Number - 370076**  
**Axle Sleeve**  
 ▼ OEM Reference

HY 2304696  
 YT 505034200



**Part Number - 360038-267**  
**Shaft Pivot**  
 ▼ OEM Reference

RA 1026637



**Part Number - 370190**  
**Shaft**  
 ▼ OEM Reference

|                   |                   |              |
|-------------------|-------------------|--------------|
| CL 7002450        | TY 00591-72261-81 | YT 504599200 |
| HY 2302981        | YT 220049717      |              |
| TY 00591-38020-81 | YT 500640818      |              |



**Part Number - 370265**  
**Shaft Pivot**  
 ▼ OEM Reference

YT 507247500





Part Number - 370045

**Pivot Pin**

▼ OEM Reference  
 HY 2046260 YT 585096303  
 HY 2046262 YT 585096305



Part Number - 370125

**Pivot Pin**

▼ OEM Reference  
 HY 3139433  
 RA 114-008-685  
 YT 220031433



Part Number - 370261

**Pivot Pin**

▼ OEM Reference  
 HY 2039120  
 YT 524140840



Part Number - 370174

**Pivot Pin**

▼ OEM Reference  
 HY 2099626  
 YT 524301377



Part Number - 370027

**Pivot Pin**

▼ OEM Reference  
 BK 992657 HY 2309397 TY 00591-58555-81  
 CL 7001856 TY 00591-30853-81 TY 00591-76570-81  
 CL 7002612 TY 00591-38395-81 YT 64857300  
 HY 2303559 TY 00591-54000-81 YT 504734200



Part Number - 370001

**Pivot Pin**

▼ OEM Reference  
 YT 585096307  
 HY 2046264  
 HY 524221067



Part Number - 370044

**Pivot Pin**

▼ OEM Reference  
 HY 2046259  
 YT 585096302



Part Number - 370107

**Pin - Lower Link Pivot**

▼ OEM Reference  
 HY 2039119 HY 2046263 YT 585096306  
 HY 2040200 YT 524140839



Part Number - 370282

**Roll Pin**

▼ OEM Reference  
 HY 2305246  
 HY 2305923  
 YT 502677902



Part Number - 370219

**Roll Pin**

▼ OEM Reference  
 JU 25700520



Part Number - 050000-095

**Roll Pin**

▼ OEM Reference  
 AC 8730573 HY 3143377 PM 301964-032  
 BK LM200142000 JU 50021409 RA 301964-032  
 BK L1036914001 JU 50180203 SL 501898  
 BK L9380620220 JU 71805830 SL 5442415  
 BK 9380620220 KM 101359 SL 8005505  
 BR PM301964-032 KO 301964-032 TY 33664-13500-71  
 BT 301964-032 LI M200142000 WG 5505  
 CL 01JM04032 LI 1036914001 YT 200078120  
 CL 3JM4032 LI 9380620220 YT 220043377  
 CL 730668 MT 0200078120 YT 272204800  
 CL 924657 MT 0200142000 YT 449034012  
 HY 2035130 MT 04207867977 YT 954508909  
 HY 2791837 NY 30304032



Part Number - 370223

**Roll Pin**

▼ OEM Reference  
 CT 25700810 KO 04025-00532 MB 948810532  
 CT 948810532 MB 09488-10532 MB W2050-11894  
 JU 25700810 MB 25700810 YT 449034019



Part Number - 370066

**Pin Coil**

▼ OEM Reference  
 RA DS227111  
 RA 810-762  
 TY 00590-00633-71



Part Number - 370262

**Pin Coiled**

▼ OEM Reference  
 HY 2050087  
 HY 2050088  
 YT 585096801  
 YT 585096802



Part Number - 370168

**Pin-Coiled Roll**

▼ OEM Reference  
 CL 2039122  
 HY 2039122  
 YT 524140842



Part Number - 370049

**Push Rod Pin**

▼ OEM Reference

|            |                   |                   |
|------------|-------------------|-------------------|
| BK 992655  | HY 3008398        | TY 00591-76721-81 |
| CL 7001861 | TY 00591-37129-81 | YT 641786100      |
| HY 2306563 | TY 00591-58542-81 | YT 641786101      |



Part Number - 370032

**Bellcrank Pin**

▼ OEM Reference  
 HY 2309006  
 TY 00591-74640-81  
 YT 518360601



Part Number - 370519

**Pin - Eccentric**

▼ OEM Reference  
 RA 1044707



Part Number - 370523

**Pin - Eccentric**

▼ OEM Reference

|            |                   |                   |
|------------|-------------------|-------------------|
| CL 7002726 | MB 219752         | TY 00591-58821-81 |
| CT 1009581 | RA 850-135-024    | TY 00591-75084-81 |
| CT 219752  | RA DS226980       | YT 220021919      |
| HY 3125492 | TY 00590-01006-71 |                   |
| MB 1009581 | TY 00591-38654-81 |                   |



Part Number - 370134

**Threaded Pin**

▼ OEM Reference  
 BT 301779-000  
 KO 301779-000  
 PM 301779-000  
 RA 301779-000



Part Number - 370018

**Link Pin**

▼ OEM Reference

|            |                   |                   |
|------------|-------------------|-------------------|
| BK 992658  | HY 3005847        | TY 00591-57741-81 |
| CL 7001855 | HY 3006808        | TY 00591-76456-81 |
| HY 2307202 | TY 00591-37127-81 | YT 64857200       |



Part Number - 370124

**Pin Weldment**

▼ OEM Reference  
 CT 1037037  
 HY 3134462  
 RA 114-007-795  
 RA DS236851  
 YT 220027831



Part Number - 370088

**Pin**

▼ OEM Reference

|                   |                   |              |
|-------------------|-------------------|--------------|
| CL 7002719        | TY 00591-76606-81 | YT 507244500 |
| TY 00591-31352-81 | YT 505654500      | YT 220037532 |
| TY 00591-58507-81 | YT 505654600      |              |



Part Number - 370568

**Pin**

▼ OEM Reference  
 RA 1055342/001  
 TY 00590-47157-71

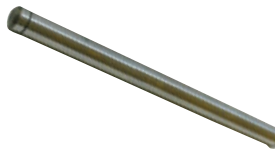

Part Number - 370021

**Pin**

▼ OEM Reference  
 HY 2304484  
 YT 502303101



Part Number - 370047

**Pin**

▼ OEM Reference  
 HY 2305824  
 TY 00591-76719-81  
 YT 640697303



Part Number - 370113

**Pin**

▼ OEM Reference  
 LI 149447  
 SL 149447



Part Number - 370112

**Pin**

▼ OEM Reference  
 LI 149463



Part Number - 370135

**Pin**

▼ OEM Reference  
 BT 47930      JU 47930      PM 47930  
 BT 600114      KO 47930      RA 47930  
 BT 650595      LR 20274P



Part Number - 370117

**Pin**

▼ OEM Reference  
 LI 149444



Part Number - 370131

**Pin**

▼ OEM Reference  
 BT 47931      LR 20275      TY 00591-43274-81  
 JU 47931      PM 47931  
 KO 47931      RA 47931



Part Number - 370118

**Pin**

▼ OEM Reference  
 LI 149448



Part Number - 370023

**Pin**

▼ OEM Reference  
 HY 2033718  
 HY 2311661  
 TY 00591-76553-81  
 YT 503688200



Part Number - 370279

**Pin**

▼ OEM Reference  
 BT 312650-000      RA 939-353-050  
 PM 312650-000      TY 00590-43547-71  
 RA 312650-000



Part Number - 370165

**Pin**

▼ OEM Reference  
 HY 2039118  
 YT 524140838



Part Number - 370570

**Pin**

▼ OEM Reference  
 BT 313067-000  
 PM 313067-000  
 RA 313067-000



Part Number - 370542

**Pin**

▼ OEM Reference  
 CL 447403      RA 116-000-340      YT 220007898  
 HY 3026642      TY 00591-75904-81



Part Number - 370294

**Pin**

▼ OEM Reference  
 HY 2033691  
 YT 502677909

**Part Number - 370573**  
**Pin (Standard)**  
 ▼ OEM Reference  
 RA 312651-002  
 TY 00590-43358-71

**Part Number - 370532**  
**Pin**  
 ▼ OEM Reference  
 HY 3126360 RA DS224777  
 RA 850-137-581 YT 220021122

**Part Number - 370559**  
**Pin**  
 ▼ OEM Reference  
 CL 7002030 MB 1055807 TY 00590-48808-71  
 CT 1055807 RA 623-003-060 TY 00591-37371-81  
 HY 3014431 RA DS232306 YT 220003792

**Part Number - 370301**  
**Pin**  
 ▼ OEM Reference  
 CT A0000-16446  
 HY 231062  
 HY 3018575  
 LP 757-4040  
 MB A0000-16446  
 MB A000016446  
 YT 501195100  
 YT 501195500

**Part Number - 370184**  
**Pin**  
 ▼ OEM Reference  
 BR PM301996002 HY 3137894 KO OP03000786  
 BR PM301996-002 HY 3137894SYS PM 301996-002  
 BT 301996-002 KO 301996-002 RA 301996-002  
 CL 921509 KO 8730181 YT 220029894

**Part Number - 360038-273**  
**Pin**  
 ▼ OEM Reference  
 AC 308439-000  
 BT 308439-000  
 KO 308439-000  
 PM 308439-000  
 RA 308439-000

**Part Number - 370186**  
**Pin**  
 ▼ OEM Reference  
 PM 301996-000

**Part Number - 370524**  
**Pin**  
 ▼ OEM Reference  
 RA 851-200-566

**Part Number - 370188**  
**Pin**  
 ▼ OEM Reference  
 CL 7002788 TY 00591-38810-81 YT 506634500  
 HY 2033820 TY 00591-58525-81 YT 507327500  
 HY 2305449 TY 00591-76629-81  
 HY 3057533 YT 220037533

**Part Number - 370090**  
**Tandem Pivot**  
 ▼ OEM Reference  
 CT 1202315  
 RA DS225210  
 RA 850-137-664  
 TY 00590-00682-71

**Part Number - 370560**  
**Pin Lower Cylinder**  
 ▼ OEM Reference  
 CL 7002031 RA 623-003-070 TY 00591-70372-81  
 CT 1055808 RA DS232307 YT 220003793  
 HY 3014432 TY 00590-48791-71  
 MB 1055808 TY 00591-37372-81

**Part Number - 370094**  
**End Cap**  
 ▼ OEM Reference  
 BK A5A BK 985194 TY 00591-70790-81  
 BK PAL18A CL 7001798 YT 220017020  
 BK PAL18AK SC 21-41501  
 BK 153451 TY 00591-30791-81

**Part Number - 360038-280**  
**Pin (Begin S/N B827N37823G)**  
 ▼ OEM Reference  
 HY 302380  
 YT 580063963



**Part Number - 370510**  
**Bushing - Spherical**

▼ OEM Reference

|                |               |               |
|----------------|---------------|---------------|
| BK 6607190001  | HY 205921     | YT 220075015  |
| BK L6607190001 | JU 14458060   | YT 580052264  |
| CT 216108      | LI 6607190001 | YT 5910609081 |
| HY 1350680     | MB 216108     |               |
| HY 1568039     | RA 460-105    |               |



**Part Number - 370166**  
**Bushing**

▼ OEM Reference  
HY HY2039226  
YT YT524140880



**Part Number - 370114**  
**Bushing**

▼ OEM Reference  
BK 153083  
LI 153083



**Part Number - 370225**  
**Bushing**

▼ OEM Reference  
JU 26904730



**Part Number - 370115**  
**Bushing**

▼ OEM Reference  
BK 153082  
LI 153082

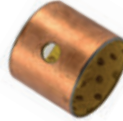

**Part Number - 370250**  
**Bushing**

▼ OEM Reference  
JU 51173883



**Part Number - 370089**  
**Bushing**

▼ OEM Reference  
HY 2033629      YT 504248505  
HY 2034088      YT 507248505  
HY 2038070      YT 585086303  
TY 00591-74609-81



**Part Number - 370251**  
**Bushing**

▼ OEM Reference  
JU 51173971



**Part Number - 370549**  
**Bushing**

▼ OEM Reference  
AC 8735796      BT 307741-000      PM 11695-12  
AC 8736462      KO 8735796      PM 307741-000  
AC OP03001395      KO 8736462      RA 851-200-257  
BT 11695-12      KO OP03001395



**Part Number - 370526**  
**Bushing - Sleeve**

▼ OEM Reference  
RA 1025348-007



**Part Number - 370551**  
**Bushing - Sleeve**

▼ OEM Reference  
CT NA012817      RA 7-460-004/002  
MB NA012817      RA DS225820



**Part Number - 370293**  
**Bushing**

▼ OEM Reference  
HY 2042864  
YT 314011168



**Part Number - 370132**  
**Bushing**

▼ OEM Reference  
BT 176827      PM 176827  
HY 2027716      RA 176827  
LR 20306      YT 912630302



**Part Number - 065007-102**  
**Bushing**

▼ OEM Reference  
AC 1902-55019      HY 2792008      MB 27807160  
AC 3BA-25-25270      HY 2792092      MB 50012676  
AC 4930406      HY 2793267      MB 50019663  
AE 109983      HY 3025470      MB 560502020  
BK 0009230231      HY 3123928      MB 77800733  
BK L0009230231      HY 800012333      MB W205010319  
BK L0199990340      HY 800075575      MT 23163  
BR AT109983      HY 800086751      MT 77800733  
CL 2754471      JU 26915362      NI AL109983  
CL 70014440      JU 27807160      TY 00591-02391-81  
CT 27807160      JU 50012676      TY 00591-36099-81  
CT 50012676      JU 50019663      TY 00591-60582-81  
CT 50019663      KO 3BA-25-25270      TY 00591-75329-81  
CT 560502020      KO 4930406      YN SA430134  
CT 77800733      KO 4967811      YT 220005064  
CT W205010319      LI 0009230231      YT 220035999  
DW A376514      LI L0009230231      YT 272019100  
HP MU23163      LI L0199990340      YT 273130200



Part Number - 370169

**Bushing**

▼ OEM Reference  
 HY 2039224  
 YT 524140878



Part Number - 310244-302-88

**Load Wheel Assembly**

▼ OEM Reference  
 CT 51064639  
 JU 51064639  
 MB 51064639



Part Number - 370254

**Bushing**

▼ OEM Reference

|            |                |                   |
|------------|----------------|-------------------|
| CL 7003600 | MB 1063128     | TY 00591-40800-81 |
| CT 1063128 | RA DS232947    | YT 220002046      |
| HY 3015671 | RA 623-005-041 |                   |



Part Number - 370231

**Load Wheel Assembly**

▼ OEM Reference

|                |             |                |
|----------------|-------------|----------------|
| CT 50136157    | JU 50136157 | MB 50136157    |
| CT 50179921    | JU 7180668  | MB 50179921    |
| CT 71305290    | JU 71305290 | MB 71305290    |
| CT W2050-11106 | JU 71806680 | MB W2050-11106 |



Part Number - 370142

**Bushing/String Guard**

▼ OEM Reference  
 YT 524148752  
 HY 2046056



Part Number - 370198

**Load Wheel Assembly**

▼ OEM Reference

CT 50265511  
 MB 50265511  
 MT 090153008  
 NI MT090153008



Part Number - 370126

**Entry Roller**

▼ OEM Reference

|          |          |                   |
|----------|----------|-------------------|
| BT 47150 | KO 47150 | PM 47150          |
| JU 47150 | LR 10281 | RA 47150          |
|          | MG 545   | TY 00591-43241-81 |



Part Number - 370017

**Exit Roller**

▼ OEM Reference

|            |                   |                   |
|------------|-------------------|-------------------|
| BK 992656  | HY 3006938        | TY 00591-54001-81 |
| HY 2307475 | TY 00591-11035-81 | YT 64857600       |
| HY 3003759 | TY 00591-30854-81 | YT 751791300      |



Part Number - 370737

**Load Wheel Assembly**

▼ OEM Reference

|            |              |              |
|------------|--------------|--------------|
| HY 4081639 | HY 4121767   | YT 582032964 |
| HY 4081688 | YT 582032962 | YT 582032968 |
| HY 4081700 | YT 582032966 |              |



Part Number - 370173

**Roller Assembly**

▼ OEM Reference

HY 2039905  
 YT 524141181



Part Number - 310478-302-88

**Wheel Kit Assembly**

▼ OEM Reference

RA 632-069/ASM



Part Number - 370317

**Wheel**

▼ OEM Reference

YT 754960401

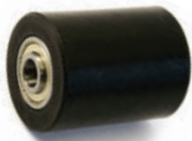

Part Number - 370127

**Load Wheel Assembly - Nylon**

▼ OEM Reference

|           |           |
|-----------|-----------|
| BT 56771  | RA 126729 |
| LR 20210N | RA 167600 |
| PM 126729 |           |
| PM 167600 |           |



Part Number - 310225-302

**Load Wheel**

▼ OEM Reference

RA 1002754-007  
 TY 00590-41747-71



**Part Number - 370296**  
**Caster Wheel Assembly**

▼ OEM Reference  
HY 1600351  
HY 1600352  
YT 580062912  
YT 580062913



**Part Number - 310261-102-YT**  
**Caster - Spring Load**

▼ OEM Reference  
CT A000021149 MB A000021149  
CT A0000-21149 MB A0000-21149  
HY 2044852 YT 580023164

▲ **WARNING:** Cancer - [www.P65Warnings.ca.gov](http://www.P65Warnings.ca.gov)



**Part Number - 370156**  
**Shim - 1/32"**

▼ OEM Reference  
BK 985849 BK PAL46132 YT 220015767  
BK 986200 BK PAL46A YT 220019486  
BK PAL46 CL 7001746



**Part Number - 370020**  
**Link**

▼ OEM Reference  
CL 7002613 HY 2307680 TY 00591-58622-81  
HY 2033719 TY 00591-38396-81 YT 500989200



**Part Number - 370091**  
**Threaded Rod**

▼ OEM Reference  
CL 2039315  
HY 2039315  
YT S00736690075  
YT 524141079



**Part Number - 370514**  
**Caster Bolt**

▼ OEM Reference  
CL 445666 MT 4207034118 TY 00591-63157-81  
CL 7001874 RA 812-001-266 YT 220002706  
HY 3007318 TY 00591-07616-81  
JU 50208484 TY 00591-30869-81



**Part Number - 370129**  
**Control**

▼ OEM Reference  
CT A000010382 NI CK924663 RA 301718-000  
KO 301718-000 PM 301718-000 YT 220043370



**Part Number - 370121**  
**Grease Fitting Flush**

▼ OEM Reference  
BK 001640 HY 3014862 RA 841-111  
BR 9872-008 HY 3055565 RA DS227104  
BR A9872-8 HY 3064274 TY 00590-00423-71  
BR CK624280 HY 3143332 TY 00591-00599-81  
BT 310546-000 LI 001640 TY 00591-36910-81  
BT 310549-000 MB 1009498 TY 00591-54032-81  
CA 624280 MB 217554 TY 00591-54033-81  
CL 624280 MB GS00-01766 YT 220003882  
CL 1313115 NI CK1313115 YT 220016081  
CT 1009498 NI CK624280 YT 220043332  
CT 217554 PM 310546-000 YT 220072237  
CT GS00-01766 PM 310549-000 YT 507167800  
HY 2302457 RA 310546-000 YT 524250487  
HY 3012701 RA 310549-000



**Part Number - 370227**  
**Grease Fitting**

▼ OEM Reference  
JU 50007986



**Part Number - 370120**  
**Grease Fitting Threaded**

▼ OEM Reference  
CL 1808279 RA 20026 TY 00590-43227-71  
HY 2042833 RA 939-352-043 YT 15628700  
JU 50013308 TY 00590-00019-21



**Part Number - 370304**  
**Grease Fitting**

▼ OEM Reference  
AC 11160-09 PM 11160-09  
BT 11160-09 RA 11160-09  
KO 11160-09 TC 11160-09



**Part Number - 370292**  
**Grease Fitting**

▼ OEM Reference  
HY 2007882  
YT 015631500



**Part Number - 370460**  
**Grease Fitting**

▼ OEM Reference  
BR 48674-FS000  
NI 48674-FS000  
TY 00591-63053-81



**Part Number - 370159**  
**Grease Fitting**

▼ OEM Reference  
RA 840-018



Part Number - 370096

**Bearing Seal**

▼ OEM Reference

|             |                |             |
|-------------|----------------|-------------|
| BK LN152669 | CT A0000-14665 | LI LI152669 |
| BK 152669   | CT A000014665  | LI 152669   |



Part Number - 370179

**Oil Seal**

▼ OEM Reference

|                |                |                   |
|----------------|----------------|-------------------|
| CL 102361      | HY 3006347     | SL S20098         |
| CL 1124E2      | HY 3125222     | TY 00590-00415-71 |
| CL 117604      | MB A0000-00050 | TY 00591-07603-81 |
| CT A0000-00050 | MB A000000050  | TY 00591-32057-81 |
| CT 1009119     | MB 1009119     | TY 00591-50668-81 |
| CT 3J4776      | MB 2I7577      | YT 220001910      |
| HY 0018773     | RA DS224928    | YT 220002307      |
| HY 0029058     | RA DS226562    | YT 220017349      |
| HY 18773       | RA 530-638     | YT 220020222      |
| HY 29058       | RA 530-688     |                   |



Part Number - 370139

**Shield Bearing**

▼ OEM Reference

|               |                   |                   |
|---------------|-------------------|-------------------|
| CL 7002777    | HY 3142320        | TY 00591-76552-81 |
| CT A000032617 | TY 00591-38769-81 | YT 503480200      |
| HY 2042262    | TY 00591-58661-81 |                   |



Part Number - 370207

**Seal Kit**

▼ OEM Reference

|            |                |                   |
|------------|----------------|-------------------|
| CL 7003597 | RA 530-712-01  | RA DS228499       |
| CT 1008994 | RA 530-725-01  | TY 00591-31900-81 |
| CT 1056005 | RA 531-103     | TY 00591-70194-81 |
| HY 3006383 | RA 531-209     | YT 220001916      |
| MB 1008994 | RA 623-005-122 |                   |



Part Number - 370209

**Seal Kit**

▼ OEM Reference

|                |
|----------------|
| CT 50033984    |
| JU 50033984    |
| MB 50033984    |
| RA 530-749-001 |



Part Number - 370255

**Seal Kit**

▼ OEM Reference

|                   |
|-------------------|
| HY 3035475        |
| RA 540-047-06     |
| TY 00591-76033-81 |
| YT 220016053      |



Part Number - 370158

**Seal**

▼ OEM Reference

|             |                   |                   |
|-------------|-------------------|-------------------|
| BK 001384   | HY 3004303        | TY 00591-32050-81 |
| BK 12AL2141 | HY 3131032        | TY 00591-54582-81 |
| CL 443535   | LI 001384         | YT 220022632      |
| CL 7003780  | SC 41-24724       | YT 220052887      |
| CT 215623   | TY 00591-00175-81 |                   |



Part Number - 370205

**Oil Seal**

▼ OEM Reference

|            |            |              |
|------------|------------|--------------|
| CL 562783  | CT 973721  | RA 530-641   |
| CL 952179  | KO 4995652 | YT 091654100 |
| CT 0973721 | RA 530-517 | YT 220004243 |
| CT 1036493 | RA 530-617 | YT 220050212 |



Part Number - 370164

**Spring**

▼ OEM Reference

|              |
|--------------|
| HY 1531075   |
| YT 580038175 |



Part Number - 370170

**Screw**

▼ OEM Reference

|            |              |              |
|------------|--------------|--------------|
| HY 2791024 | HY 296203    | YT 277274300 |
| HY 2798772 | YT 273075800 | YT 580013990 |



Part Number - 370172

**Washer**

▼ OEM Reference

|             |              |               |
|-------------|--------------|---------------|
| BR 9878-024 | LP 1069-1210 | YT 2720064007 |
| HY 2035534  | YT 062960000 |               |



Part Number - 370263

**Washer**

▼ OEM Reference

|              |
|--------------|
| HY 2307951   |
| YT 065055200 |



Part Number - 360038-265

**Washer**

▼ OEM Reference

|               |
|---------------|
| AC 301776-000 |
| BT 301776-000 |
| KO 301776-000 |
| PM 301776-000 |
| RA 301776-000 |





Part Number - 360038-270

### Cap Screw

▼ OEM Reference  
 HY 2043856  
 YT 524144586



Part Number - 370175

### Flanged Bearing

▼ OEM Reference  
 HY 2100235  
 YT 524302804



Part Number - 370194

### Plate Carrier

▼ OEM Reference

|              |                   |                   |
|--------------|-------------------|-------------------|
| CL 7002175   | RA 623-010-154    | TY 00591-70849-81 |
| CT 1055823   | RA 828-008-204    | YT 220017203      |
| CT NA012934C | RA DS237267       |                   |
| HY 3039852   | TY 00591-31076-81 |                   |



Part Number - 370267

### Plate Carrier

▼ OEM Reference  
 RA 623-010-109



Part Number - 370162

### Spacer

▼ OEM Reference

|            |                   |              |
|------------|-------------------|--------------|
| CL 7001735 | TY 00591-30752-81 | YT 121357100 |
| HY 2037487 | TY 00591-60741-81 | YT 220035779 |
| HY 3007123 | TY 00591-76463-81 |              |



Part Number - 370266

### Spacer

▼ OEM Reference  
 RA 1031101



Part Number - 370180

### Tube Spacer

▼ OEM Reference  
 RA 1045247-001



Part Number - 370210

### Swivel Assembly

▼ OEM Reference

|                |               |                   |
|----------------|---------------|-------------------|
| CL 7001918     | RA 870-410-17 | RA 870-410-26     |
| HY 3018295     | RA 870-410-20 | RA 870-410-27     |
| PM 200903      | RA 870-410-22 | TY 00591-30924-81 |
| PM QJ-112207   | RA 870-410-23 | TY 00591-63170-81 |
| PM QJB-002881  | RA 870-410-24 | YT 220002254      |
| RA 787-047-100 | RA 870-410-25 |                   |



Part Number - 060009-037

### Retaining Ring

▼ OEM Reference  
 RA 810-131



Part Number - 380700-015

### Shaft

▼ OEM Reference

|                |                |                   |
|----------------|----------------|-------------------|
| BT 623-003-040 | HY 3016454     | RA 623-003-040    |
| BT 623-003-041 | HY 3126892     | RA 623-003-041    |
| BT 828-005-287 | MB 1055875     | RA 828-005-287    |
| BT 828-006-676 | MB A0000-31451 | RA 828-006-676    |
| BT DS232229    | PM 623-003-040 | RA DS232229       |
| CL 7001990     | PM 623-003-041 | TY 00590-48784-71 |
| CT 1055875     | PM 828-005-287 | TY 00591-30966-81 |
| CT A0000-31451 | PM 828-006-676 | YT 220017887      |
| GM 0712-99XF   | PM DS232229    | YT 220034271      |



Part Number - 380700-016

### Shaft

▼ OEM Reference

|                |                |                |
|----------------|----------------|----------------|
| BT 828-005-286 | PM 828-005-286 | RA 828-006-678 |
| BT 828-006-678 | PM 828-006-678 | RA DS232228    |
| BT DS232228    | PM DS232228    | YT 220034270   |
| HY 3126890     | RA 828-005-286 |                |



| Part Number   | Description  | OEM Reference |                |
|---------------|--|---------------|----------------|
| 361038-279    | Back-Up Alarm  |               |                |
| 370259        | Battery Charger - AMG & Flooded Batteries - S.N. B827N55791L & later |               |                |
| 370252        | Battery Charger - Micro Control                                      |               |                |
| 370005        | Battery Discharge Indicator  | HY 2046546    | YT 580026708   |
| 310261-102-YT | Caster Assembly  | HY 2044852    | YT 580023164   |
| 310282        | Caster Wheel   | HY 2046537    | YT 524149213   |
| 370660        | Contactora - S.N. B827   |               |                |
| 3C0016-R      | Controller   | HY 2045951-R  | YT 585098300-R |
| 340077-005    | Fuse 5 amp   |               |                |
| 802816-009    | Fuse 150 amp   | HY 354589     | YT 504450730   |
| 340047-175    | Fuse 175 amp   |               |                |
| 102126-002    | Ground Strap   |               |                |
| 370061        | Hub  | HY 2049428    | YT 501087300   |
| 370054        | Ignition Switch  | HY 3005833    | YT 500863104   |
| 370087        | Key - 1 piece  | HY 262798     | YT 500863106   |
| 370041        | Pump Motor - S.N. B827   | HY 1466025    | YT 580012669   |
| 084343        | Solenoid   | HY 1198392    |                |

⚠ **WARNING:** Cancer - [www.P65Warnings.ca.gov](http://www.P65Warnings.ca.gov)

**Handle Assembly - Control Arm**

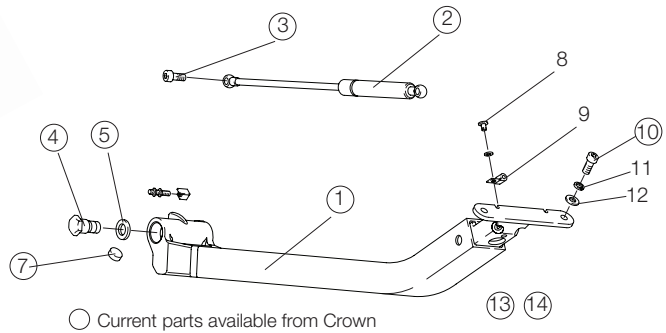

○ Current parts available from Crown

**1 - Steer Arm Tiller Assembly**  
P.N. 370011

▼ OEM Reference  
HY 2050082  
YT 524143951

**4 - Steer Arm Pin**  
P.N. 370006

▼ OEM Reference  
HY 2059695  
YT 272027800

**2 - Gas Spring**  
P.N. 370008

▼ OEM Reference  
HY 2050083  
YT 524149338

**5 - Washer**  
P.N. 370012

▼ OEM Reference  
HY 2791931  
YT 272006400

**3 - Pin**  
P.N. 370060

▼ OEM Reference  
HY 302375  
YT 580031999

**7 - Bumper (2 Required)**  
P.N. 360038-271

▼ OEM Reference  
HY 2050084  
YT 524149326

**10 - Cap Screw**  
P.N. 360038-251

▼ OEM Reference  
HY 296166  
YT 900014292

**13 - Cap Screw**  
P.N. 360038-270

▼ OEM Reference  
HY 2043856  
YT 524144586

**14 - Handle Wiring Harness**  
P.N. 370015

▼ OEM Reference  
HY 2066432  
YT 580046976

**Control Handle Assembly**

**1 & 2 - Control Handle Upper/Lower Set**  
P.N. 370259

**3 - Card Interface Single-R**  
P.N. 370302-R

▼ OEM Reference  
HY 1498101  
YT 582006562

**4 - Switch Assembly**  
P.N. 370058

▼ OEM Reference  
HY 1466877  
YT 524148521

**5 - Switch**  
P.N. 370289

▼ OEM Reference  
HY 1498102  
YT 580026824

**7 - Switch Cover**  
P.N. 370163

▼ OEM Reference  
HY 1467779  
YT 580011991

**9 - Spring**  
P.N. 370628

▼ OEM Reference  
HY 1466606  
YT 580012969

**15 - Spring**  
P.N. 370077

▼ OEM Reference  
HY 1466607  
YT 580012970

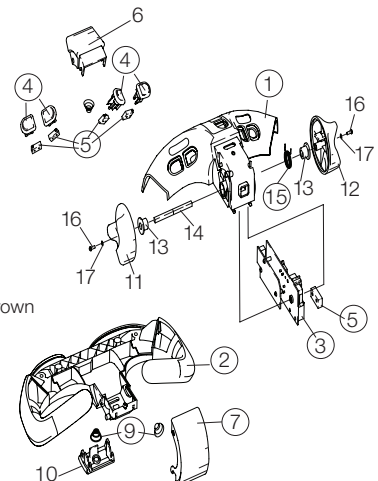

○ Current parts available from Crown

**Drive Unit and Brake Assembly**

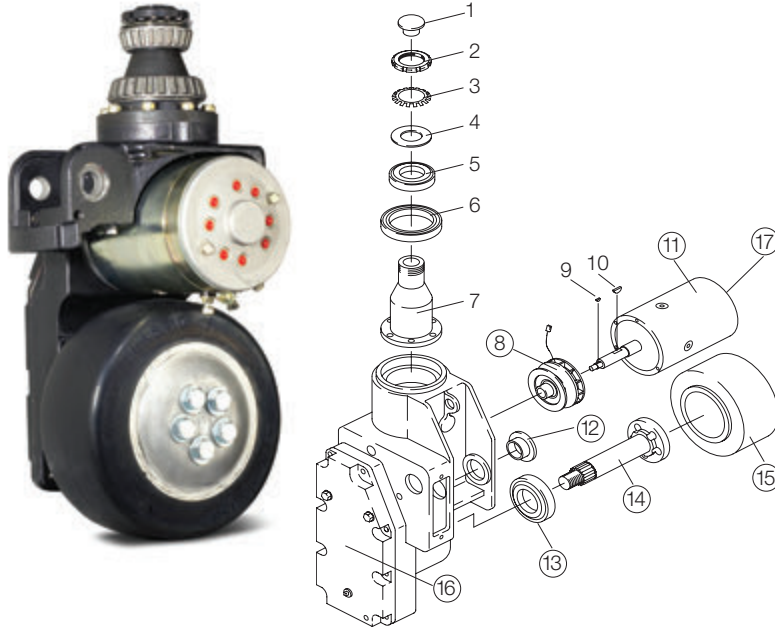

○ Current parts available from Crown

**8 - Brake Assembly**

P.N. 370038

▼ OEM Reference  
HY 2046003  
YT 524148583

**11 - Drive Motor**

P.N. 370043

▼ OEM Reference  
HY 2049316  
YT 580031000

**12 - Bushing**

P.N. 370019

▼ OEM Reference  
HY 2791987  
YT 272015100

**13 - Bearing Cup**

P.N. 065105

▼ OEM Reference  
HY 163971  
YT 055076400

**14 - Drive Axle**

P.N. 370031

▼ OEM Reference  
HY 2304321  
YT 506566500

**15 - Poly Tire**

P.N. 077848-xxx-xx

▼ OEM Reference  
HY 2045112  
YT 524142925

**15 - Rubber Tire**

P.N. 076751-xxx

▼ OEM Reference  
HY 2045107  
YT 524142926

**16 - Motor Cover (RH as viewed from operator)**

P.N. 370034

▼ OEM Reference  
HY 1495763  
YT 524144502

**16 - Motor Cover (LH as viewed from operator)**

P.N. 370035

▼ OEM Reference  
HY 1495764  
YT 524144503

**17 - Drive Motor Brush Set & Springs**

P.N. 370042

▼ OEM Reference  
HY 1506791  
YT 580029149

**Hyster W40 XL / W40 XT**

**Drive Unit and Brake Assembly**

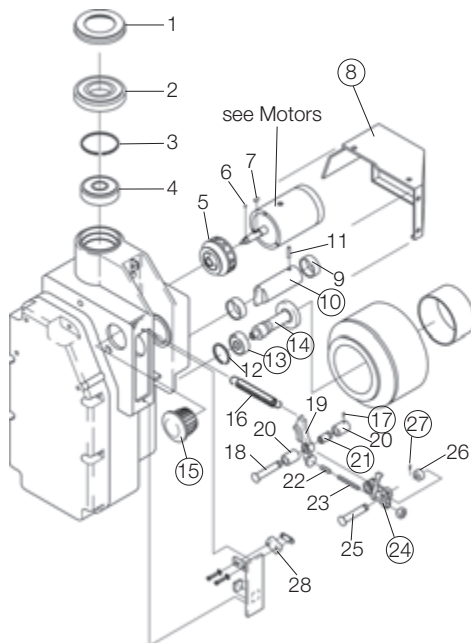

○ Current parts available from Crown

**8 - Drive Motor Cover**

P.N. 370024

▼ OEM Reference  
HY 2041689

**10 - Shaft**

P.N. 370030

▼ OEM Reference  
HY 2305815

**13 - Bearing Cup**

P.N. 065105

▼ OEM Reference  
HY 163971

**13 - Bearing Cone**

P.N. 065106

▼ OEM Reference  
HY 174230

**14 - Drive Axle**

P.N. 370031

▼ OEM Reference  
HY 2304321

**15 - Plug**

P.N. 370055

▼ OEM Reference  
HY 2307952

**17 - Cotter Pin**

P.N. 060038-013

▼ OEM Reference  
HY 2302589

**21 - Bushing**

P.N. 370052

▼ OEM Reference  
HY 2302396

**24 - Brake Cam Lever**

P.N. 370196

▼ OEM Reference  
HY 2304545

**27 - Cotter Pin**

P.N. 060038-002

▼ OEM Reference  
HY 15200

Part Number - 370011

**Steer Arm**

▼ OEM Reference  
HY 2050082  
YT 524143951



Part Number - 370025

**Steer Arm Weldment**

▼ OEM Reference  
HY 2308794  
YT 503771700



Part Number - 370299

**Tiller Handle Weldment**

▼ OEM Reference  
YT 582003278



Part Number - 370318

**Handle Stem Weld (Mach)**

▼ OEM Reference  
AC OP03001390 KO 8733377  
BT 301766-000 KO OP03001390  
KO 8730369 PM 301766-000 RA 301766-000



Part Number - 351096-345

**Tiller Handle**

▼ OEM Reference  
RA 1066425-001



Part Number - 370312

**Yoke**

▼ OEM Reference  
RA 301721-000



Part Number - 370259

**Control Handle Upper/Lower Set**

Offering the complete handle instead of separate upper and lower pieces.

▼ OEM Reference

HY 1467778 HY 4005445 YT 550005599  
HY 2045501 YT 524139006 YT 580011989



Part Number - 370264

**Handle Assembly**

▼ OEM Reference  
YT 550013954



Part Number - 370548

**Rabbit Button - Left**

▼ OEM Reference  
CT 1041752  
MB 1041752  
RA 850-138-146



Part Number - 370564

**Button - Right Rabbit**

▼ OEM Reference  
RA 850-138-145  
TY 00590-47338-71



Part Number - 370552

**Handle Kit - With Hole**

▼ OEM Reference

|            |                   |                   |
|------------|-------------------|-------------------|
| BK 709802  | MB 215835         | TY 00591-35105-81 |
| CL 7000891 | RA 154-002-535    | TY 00591-35106-81 |
| CL 7001859 | RA 360-019        | TY 00591-63096-81 |
| CT 215835  | RA 360-919        | TY 00591-63097-81 |
| HY 3007931 | SC 25-40466       | YT 220027886      |
| HY 3136092 | SC 33-01855       |                   |
| LI 709802  | TY 00591-30856-81 |                   |



Part Number - 370563

**Actuator - Cam Assembly (Clear)**

▼ OEM Reference

|             |                |              |
|-------------|----------------|--------------|
| CT NA013594 | RA 850-135-945 | RA DS226464  |
| HY 3127435  | RA 850-138-049 | YT 220022103 |
| MB NA013594 | RA 850-138-076 |              |



Part Number - 360038-269

**Handle Grip**

▼ OEM Reference  
HY 2311072  
YT 519305803  
YT 620086100



Part Number - 398000-087

**Handle Grip**

▼ OEM Reference

|                    |                    |
|--------------------|--------------------|
| HY 800041750       | RA 850-135-971/001 |
| RA 1018936-001     | TY 00590-47247-71  |
| RA 1027267-001     | YT 800041750       |
| RA 850-135-971-001 |                    |





Part Number - 370571

**Grip**

▼ OEM Reference  
RA 301720-000



Part Number - 370520

**Handle Bearing**

▼ OEM Reference

|             |                |              |
|-------------|----------------|--------------|
| CT NA013590 | MB NA013590    | RA DS226465  |
| HY 3126421  | RA 850-135-959 | YT 220020786 |



Part Number - 380700-017

**Pivot Pin - Handle**

▼ OEM Reference

|                |                |                |
|----------------|----------------|----------------|
| BT 850-135-970 | PM 850-135-970 | RA 850-138-996 |
| BT 850-138-996 | PM 850-138-996 | RA DS226076    |
| BT DS226076    | PM DS226076    | YT 220020943   |
| HY 3126312     | RA 850-135-970 |                |



Part Number - 380500-933

**Spring**

▼ OEM Reference

|           |                   |
|-----------|-------------------|
| BT 167836 | RA 167836         |
| PM 167836 | TY 00590-42420-71 |

Note: Used with P.N. 370195



Part Number - 370738

**Handle Return Spring**

▼ OEM Reference  
TY 00590-43300-71



Part Number - 370574-00R

**Handle Assembly Remanufactured - Standard**

▼ OEM Reference  
RA 1014652-002-R  
RA 1014652-102-R



Part Number - 370007

**Handle Switch**

▼ OEM Reference  
HY 2049350  
YT 524153715



Part Number - 370740

**Premium Tiller Wire Harness**

▼ OEM Reference  
HY 4634734  
YT 582038475



Part Number - 370015

**Handle Wiring Harness**

▼ OEM Reference  
HY 2066432  
YT 580046976



Part Number - 370285

**Harness**

▼ OEM Reference  
RA 10314271-001



Part Number - 370039

**Handle Wiring Harness Assembly**

▼ OEM Reference  
HY 2035394  
YT 580002386



Part Number - 370281

**Head Harness**

▼ OEM Reference

|              |                |                   |
|--------------|----------------|-------------------|
| BT 313436-00 | PM 313436-000  | TY 00590-43482-71 |
| PM 313436-00 | RA 313436-00   | TY 939-353-134    |
|              | RA 939-353-134 |                   |



Part Number - 370325

**Harness, Handle Stem**

▼ OEM Reference

|                 |               |               |
|-----------------|---------------|---------------|
| AC OP03001434   | KO 8734720    | PM 307193-000 |
| BR PM305881-000 | KO 8735479    | RA 305881-000 |
| BT 305881-000   | KO OP03001434 | RA 307193-000 |
|                 | PM 305881-000 |               |



Part Number - 370562

**Travel Harness**

▼ OEM Reference

|                |                |                |
|----------------|----------------|----------------|
| BT 850-136-859 | PM 850-136-859 | RA 850-136-859 |
| BT 850-136-927 | PM 850-136-927 | RA 850-136-927 |



Part Number - 370289

**Switch**

▼ OEM Reference  
HY 1498102  
YT 580026824



Part Number - 370288

**Button**

▼ OEM Reference  
YT 524149804



Part Number - 370439

**Switch Assembly  
Comp Lower Micro**

▼ OEM Reference  
BR 48411-FS004 NI 48411-FS004  
BR 48487-FS001 NI 48487-FS001



Part Number - 370773

**Button - Handle  
Creep Speed Switch**

▼ OEM Reference  
YT 582007134



Part Number - 370058

**Switch Assembly - 2 Wire**

▼ OEM Reference  
HY 1466877  
YT 524148521



Part Number - 398000-094

**Button - Lift/Lower**

▼ OEM Reference  
BT 1041754 RA 850-138-654 YT 800131363  
HY 800129472 RA 1041754  
PM 1041754 TY 00590-47341-71



Part Number - 380700-026

**Switch Assembly**

▼ OEM Reference  
BT 850-138-298-001 CT NA17440 PM 850-138-298-001  
BT 850-139-149-001 MB NA013127 PM 850-139-149-001  
CT NA013127 MB NA017440 RA 850-138-298-001  
CT NA017440 MB NA13127 RA 850-139-149-001  
CT NA13127 MB NA17440 TY 00590-02108-71



Part Number - 360038-278

**Button Nose Assembly**

▼ OEM Reference  
RA 850-135-976-001



Part Number - 370195

**Button Reverser**

▼ OEM Reference  
TY 00590-47054-71  
Note: Replacement spring:  
P.N. 380500-933



Part Number - 370566

**Switch - Reverser**

▼ OEM Reference  
RA 851-200-891



Part Number - 370332

**Button Reverser**

▼ OEM Reference  
RA 1036419/001



Part Number - 380700-025

**Grab Bar Switch  
Assembly**

▼ OEM Reference  
PM 1066671-001  
RA 1066671-001



Part Number - 370458

**Belly, SW, CVR**

▼ OEM Reference  
BR 48495-FS000  
NI 48495-FS000



Part Number - 370749

**Horn Contact Set**

▼ OEM Reference  
HY 1374067 YT 518794640  
HY 1391205 YT 580000284



Part Number - 370163

**Cover Switch**

▼ OEM Reference  
HY 1467779  
YT 580011991



**Part Number - 370761**  
**Horn Cover**  
 ▼ OEM Reference  
 HY 1489471  
 YT 524139009  
 YT T582003460



**Part Number - 370315**  
**Lower Cover**  
 ▼ OEM Reference  
 RA 313060-001



**Part Number - 351096-243**  
**Potentiometer**  
 ▼ OEM Reference  
 RA 851-200-951



**Part Number - 370517**  
**Potentiometer**  
 ▼ OEM Reference  
 CL 7003758 RA 1007256/004 TY 00591-32042-81  
 HY 3026968 RA 1-007-256-004 TY 00591-63080-81  
 RA 1007256004 RA 1-120-112-004 YT 220007740



**Part Number - 380700-002**  
**Potentiometer**  
 ▼ OEM Reference  
 BT 1-120-098 MB 1009543 RA 1-120-105  
 BT 1-120-105 MB NA014027 RA 1120105  
 BT 1120105 MB NA014028 RA DS224314  
 BT DS224314 PM 1-120-098 TY 00590-04513-71  
 CL 448169 PM 1-120-105 TY 00590-42169-71  
 CT 1009543 PM 1120105 YT 220018415  
 CT NA014027 PM DS224314  
 CT NA014028 RA 1-120-098



**Part Number - 370742**  
**Potentiometer, Accelerator (Pedal Position Sensor)**  
 ▼ OEM Reference  
 CT A0000-16080 MB A0000-16080  
 HY 1354990 YT 505966574



**Part Number - 351096-322**  
**Potentiometer**  
 ▼ OEM Reference  
 RA 1053639



**Part Number - 370736**  
**Bumper, Control Handle**  
 ▼ OEM Reference  
 HY 2302746  
 YT 504732200



**Part Number - 370220**  
**Drive Tire**  
 ▼ OEM Reference  
 JU 50460101



**Part Number - 370779**  
**Drive Wheel - Rubber**  
 ▼ OEM Reference  
 CT 51031747



**Part Number - 380700-023**  
**Encoder**  
 ▼ OEM Reference  
 BT 1-185-006/001 MB A0000-13359 RA 1-185-006/001  
 BT 1-185-006/006 PM 1-185-006/001 RA 1-185-006/006  
 CT A0000-13359 PM 1-185-006/006



**Part Number - 370550**  
**Sensor Proximity**  
 ▼ OEM Reference  
 RA 1022003/001



**Part Number - 370555**  
**Encoder Bearing**  
 ▼ OEM Reference  
 RA 1012203



**Part Number - 370006**  
**Handle Pin**  
 ▼ OEM Reference  
 HY 2059695 HY 2793129 YT 524179191  
 HY 2062561 YT 272027800 YT 524179191A  
 HY 2792053 YT 272311800 YT 524190001



**Part Number - 370012**  
**Handle Pin Washer**  
 ▼ OEM Reference  
 HY 2791931  
 YT 272006400



**Part Number - 370031**  
**Drive Axle**

▼ OEM Reference

- |            |              |              |
|------------|--------------|--------------|
| HY 2303658 | HY 2311203   | YT 640846831 |
| HY 2304321 | YT 501785300 | YT 640846878 |
| HY 2304729 | YT 506566500 |              |



**Part Number - 370019**  
**Bushing**

▼ OEM Reference

- |                |                 |              |
|----------------|-----------------|--------------|
| BK L0039169600 | HY 2799263      | YT 272015100 |
| CL 925414      | LI LI0039169600 | YT 277323300 |
| HY 2791987     |                 |              |



**Part Number - 370280**  
**Drive Axle**

▼ OEM Reference

- |              |
|--------------|
| HY 2308632   |
| YT 508149300 |
| YT 720148300 |



**Part Number - 370557**  
**Spring Arm**

▼ OEM Reference

- |               |                |
|---------------|----------------|
| BT 313665-086 | RA 114-008-660 |
| PM 313665-086 | RA 313665-086  |

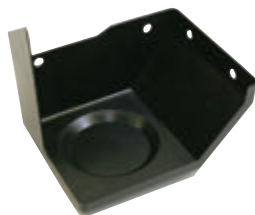

**Part Number - 370024**  
**Drive Motor Cover**

▼ OEM Reference

- |              |
|--------------|
| HY 2041689   |
| HY 2306863   |
| YT 503753700 |
| YT 580017142 |



**Part Number - 380700-022**  
**Compression Spring**

▼ OEM Reference

- |                |                |                   |
|----------------|----------------|-------------------|
| AC 8126-90020  | KO 8126-90020  | RA DS226290       |
| BT 830-204     | MB 1075082     | TY 00590-00139-71 |
| BT 921-000-581 | PM 830-204     | TY 00591-21100-81 |
| BT DS226290    | PM 921-000-581 | YT 220019667      |
| CT 1075082     | PM DS226290    | YT 220043155      |
| HY 3124295     | RA 830-204     |                   |
| HY 3143155     | RA 921-000-581 |                   |



**Part Number - 370030**  
**Shaft**

▼ OEM Reference

- |              |
|--------------|
| HY 2305815   |
| YT 505984500 |



**Part Number - 370535**  
**Steer Shaft**

▼ OEM Reference

- |                    |                    |
|--------------------|--------------------|
| BT 828-013-690/001 | RA 828-005-711-001 |
| RA 828-003-921-001 | RA 828-013-690-001 |



**Part Number - 370077**  
**Spring**

▼ OEM Reference

- |              |
|--------------|
| HY 1466607   |
| YT 580012970 |



**Part Number - 370628**  
**Spring**

▼ OEM Reference

- |              |
|--------------|
| HY 1466606   |
| YT 580012969 |



**Part Number - 370319**  
**Housing**

▼ OEM Reference

- |           |
|-----------|
| BT 167822 |
| PM 167822 |
| RA 167822 |



**Part Number - 370739**  
**Bushing, Control Handle Pivot**

▼ OEM Reference

- |                   |
|-------------------|
| TY 00590-43300-71 |
|-------------------|



**Part Number - 370052**  
**Bushing**

▼ OEM Reference

- |                   |
|-------------------|
| HY 2302396        |
| TY 00591-76732-81 |
| YT 723673100      |



**Part Number - 370527**  
**Spring**

▼ OEM Reference

- |               |             |               |
|---------------|-------------|---------------|
| BT 312268-000 | CT NA021466 | PM 312268-000 |
| BT 830-243    | MB NA015902 | RA 830-243    |
| CT NA015902   | MB NA021466 | RA 830-426    |





Part Number - 370053

**Pivot Pin**

▼ OEM Reference  
HY 2302412  
YT 723683100



Part Number - 370060

**Pin**

▼ OEM Reference  
HY 302375  
YT 580031999



Part Number - 370055

**Plug**

▼ OEM Reference  
HY 2307952  
YT 501864902



Part Number - 370008

**Gas Spring**

▼ OEM Reference  
HY 2050083      YT 524149338      YT 580083554  
HY 2066312      YT 580046812



Part Number - 370003

**Gas Spring**

▼ OEM Reference  
HY 2040528      YT 524141471      YT 580046627  
HY 2047141      YT 524149833      YT 580046811  
HY 2066311      YT 524182270



Part Number - 351096-287

**Gas Spring Kit**

▼ OEM Reference  
CT NA022586      RA 543-005      TY 00591-76108-81  
RA 1034932-K02      RA 838-010-967/001  
RA 543-000-001      RA 838-900-019



Part Number - 370348

**Gas Spring**

▼ OEM Reference  
HY 4602528  
YT 582002563



Part Number - 370764

**Gas Spring**

▼ OEM Reference  
HY 4062322  
HY 4047416  
YT 582031382



Part Number - 370763

**Gas Spring**

▼ OEM Reference  
HY 4602216  
YT 582002075



Part Number - 370767

**Gas Spring**

▼ OEM Reference  
HY 2066309      HY 4009088  
HY 2063916      YT 582003113



Part Number - 370191

**Spring Handle Return**

▼ OEM Reference  
KO 301765-000  
KO 8730367  
KO OP03001388  
PM 301765-000  
RA 851-200-415  
TY 00591-75880-81  
YT 220043000  
YT 220043373



Part Number - 370065

**Washer - Flat**

▼ OEM Reference  
CT 1009446      RA DS226870      TY 00590-00015-71  
MB 1009446      RA 771-156



Part Number - 370068

**Belt Timing Kit**

▼ OEM Reference  
CT 1051301  
RA 828-900-067



Part Number - 370531

**Timing Belt**

▼ OEM Reference  
CT 1201878      MB 1201878-BAN      YT 220019256-BAN  
CT 1201878-BAN      RA 828-005-180      YT 220044568  
HY 3144568      RA 828-005-180-BAN      YT 220044568-BAN  
HY 3144568-BAN      RA 828-900-067-A  
MB 1201878      RA 828-900-067-A-BAN

## Drive Unit, Brake, and Steering



Part Number - 370038

### Brake Assembly

▼ OEM Reference  
HY 2046003  
YT 524148583



Part Number - 370518

### Brake - Hydraulic

▼ OEM Reference  
CT A000031447 RA 870-901-001  
MB A000031447 RA 870-930



Part Number - 380700-028

### Hydraulic Brake

▼ OEM Reference

BT 870-923-100 PM 870-923-100 RA 870-923-100  
BT 870-925-001 PM 870-925-001 RA 870-925-001



Part Number - 351096-254

### Brake Assembly, Electric

▼ OEM Reference  
RA 1065061

**NEW!**



Part Number - 370778

### Brake - Electric

▼ OEM Reference  
YT 580067255



Part Number - 370148

### Brake - Electromagnetic

▼ OEM Reference  
HY 2055944  
YT 524169212



Part Number - 370196

### Brake Cam Lever

▼ OEM Reference  
HY 2304545  
YT 505354500



Part Number - 370512

### Deadman Pad

▼ OEM Reference  
RA 114-022-002



Part Number - 370102

### Disc - Brake

▼ OEM Reference  
RA 870-920-119



Part Number - 370103

### Disc - Brake

▼ OEM Reference  
RA 870-923-111



Part Number - 370098

### Disc - Brake

▼ OEM Reference  
CT NA014187 MB NA014187 RA 870-901-115  
CT 1050475 RA 870-834-121 TY 00591-76120-81



Part Number - 370097

### Plate - Friction

▼ OEM Reference  
CT 1050473  
RA 870-834-119

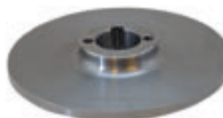

Part Number - 370099

### Rotor - Brake

▼ OEM Reference  
RA 870-920-120

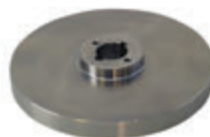

Part Number - 370100

### Rotor - Brake

▼ OEM Reference  
CT NA052004  
MB NA052004  
RA 870-856-111



Part Number - 370200

### Rotor - Brake

▼ OEM Reference  
CT 1050474  
GM 0681-17JX  
HY 3142755  
MB 1050474  
RA 870-834-120  
YT 220042755



Part Number - 370201

### Cylinder Inner

▼ OEM Reference  
DS P264-0012 RA 821-900-039-002  
RA 820-001-711 RA 870-616  
RA 820-002-013 RA 870-747  
RA 820-002-173 RA 870-747-100  
RA 820-900-019 RA 870-747-200  
RA 821-900-039-001 TY 00591-57992-81



Part Number - 370772

### Parking Brake Cable

▼ OEM Reference  
CL 448567  
TY 46401-12240-71



Part Number - 3J97220-05200-R  
**Pump R-Motor 36/48V**  
 ▼ OEM Reference  
 CT 97220-05200



Part Number - 3J570-287-500-R  
**Pump R-Motor 36V**  
 ▼ OEM Reference  
 RA 570-287-500



Part Number - 370041  
**Pump AM Motor 24V**  
 ▼ OEM Reference  
 HY 1466025  
 YT 580012669



Part Number - 3J570-236-500-R  
**Pump R-Motor 36V**  
 ▼ OEM Reference  
 RA 570-236-500



Part Number - 3J5045752-33-R  
**Pump R-Motor 36V**  
 ▼ OEM Reference  
 HY 2305653  
 YT 5045752-33



Part Number - 3J570-367-500-R  
**Pump R-Motor 36V**  
 ▼ OEM Reference  
 RA 570-367-500



Part Number - 3J14510U116071-R  
**Pump R-Motor**  
 ▼ OEM Reference  
 TY 14510-U1160-71



Part Number - 3J570-358-451-R  
**Pump R-Motor 36V**  
 ▼ OEM Reference  
 OH D-481581X7147A  
 RA 570-358-450  
 RA 570-358-451



Part Number - 3J2304547-R  
**Pump R-Motor 12V**  
 ▼ OEM Reference  
 HY 2304547  
 HY 2311188

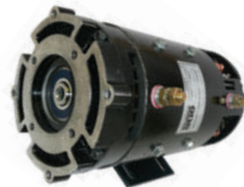

Part Number - 3J570-317-500-R  
**Pump R-Motor 24V**  
 ▼ OEM Reference  
 RA 570-317-500



Part Number - 3J005904128971-R  
**Pump R-Motor 24V**  
 ▼ OEM Reference  
 TY 00590-41289-71



Part Number - 3J570-379-451-R  
**Auxiliary Pump R-Motor 36V**  
 ▼ OEM Reference  
 RA 570-379-451



Part Number - 3J143201224171-R  
**Pump R-Motor**  
 ▼ OEM Reference  
 TY 14320-12241-71



Part Number - 3J570-299-500-R  
**Pump R-Motor 24/36V**  
 ▼ OEM Reference  
 RA 570-299  
 RA 579-299  
 RA 570-299-500



Part Number - 3J570-273-500-R  
**Pump R-Motor 36/48V**  
 ▼ OEM Reference  
 RA 570-273-500



Part Number - 3J570-269-500-R

**Pump R-Motor 36V**

▼ OEM Reference  
RA 570-269-500



Part Number - 3J1016481-450-R

**Pump R-Motor 36V**

▼ OEM Reference  
RA 1016481-450 RA C42-1215X6377A  
RA 1016481/450R RA C-421215X6377A-R



Part Number - 3J570-412-R

**Pump R-Motor 24V**

▼ OEM Reference  
RA 570-412



Part Number - 3J70-049-00-R

**Drive R-Motor 24-36-48 V**

▼ OEM Reference  
AV ER5-4001 GE 5BC48JB814  
AV ER9-4004 GE 5BC58JBS6110A  
BJ D387 GE 5BC58JBS6110B  
GE 5BC48JB550 GE 5BC48JBS6344  
GE 5BC48JB550B TA 70-025-20  
GE 5BC48JB582 TA 70-049-00  
GE 5BC48JB754B TA 70-049-00-R



Part Number - 370298

**Pump & Motor Assembly Hydraulic**

▼ OEM Reference  
BT 1163002/001  
RA 1163002-001



Part Number - 3J70-052-40-R

**Drive R-Motor 24-36-48 V**

▼ OEM Reference  
AV DD3-4004 TA 70-052-40  
AV DD3-4004-R TA 70-052-40-R



Part Number - 3J851-200-859-R

**Pump R-Motor 24V**

▼ OEM Reference  
RA 851-200-859



Part Number - 3J570-867-500-R

**Drive R-Motor 24V**

▼ OEM Reference  
RA 570-867-500



Part Number - 3J143201224071-R

**Pump R-Motor 36V**

▼ OEM Reference  
TY 14320-12240-71



Part Number - 3J570-388-500-R

**Drive R-Motor 36V**

▼ OEM Reference  
RA 570-388-500



Part Number - 3J1020545-450-R

**Pump R-Motor 36V**

▼ OEM Reference  
BT 1020545-450  
BT 1020545-450-R  
DW 1020545-450  
DW 1020545-450-R  
OH E48-1207X7165A  
OH E48-1207X7165-R  
PM 1020545-450  
PM 1020545-450-R  
RA 1020545-450  
RA 1020545-450-R



Part Number - 3J570-863-500-R

**Drive R-Motor 36V**

▼ OEM Reference  
RA 570-863-500



Part Number - 3J570-869-701-R  
**Drive R-Motor 24V**  
 ▼ OEM Reference  
 RA 570-869-701



Part Number - 3J570-350-500-R  
**Drive R-Motor 24V**  
 ▼ OEM Reference  
 AD AN6-4003  
 RA 570-350-500  
 RA 579-350  
 RA AN6-4003



Part Number - 3J570-348-500-R  
**Drive R-Motor 36V EASI**  
 ▼ OEM Reference  
 RA 570-348-500



Part Number - 3J570-869-500-R  
**Drive R-Motor 24V**  
 ▼ OEM Reference  
 RA 570-869-500



Part Number - 3J570-325-500-R  
**Drive R-Motor 24V**  
 ▼ OEM Reference  
 RA 570-325-500  
 RA 570-867-500  
 TY 00590-40563-71



Part Number - 3J570-415-500-R  
**Drive R-Motor 24V**  
 ▼ OEM Reference  
 RA 570-415-500-R



Part Number - 3J570-392-500-R  
**Drive R-Motor 36V**  
 ▼ OEM Reference  
 RA 570-392-500



Part Number - 3J570-368-500-R  
**Drive/Traction R-Motor 36V Pacer**  
 ▼ OEM Reference  
 RA 570-368-500



Part Number - 3J570-400-500-R  
**Drive/Traction R-Motor 36V**  
 ▼ OEM Reference  
 RA 570-400-500



Part Number - 3J570-415-201-R  
**Drive R-Motor 24V**  
 ▼ OEM Reference  
 RA 570-415-201



Part Number - 3J570-298-500-R  
**Drive R-Motor 24/36V**  
 ▼ OEM Reference  
 CT 1008792  
 MB 1008792  
 RA 570-298-500



Part Number - 3J570-251-200-R  
**Drive R-Motor 36V**  
 ▼ OEM Reference  
 RA 570-251/200



Part Number - 370043  
**Drive Motor 24V AM**  
 ▼ OEM Reference  
 HY 2049316  
 YT 580031000



Part Number - 3J325744-R  
**Drive R-Motor 36/48V**

▼ OEM Reference  
 HY 325744  
 HY 1461192



Part Number - 3J2798867-R  
**Drive R-Motor 24V**

▼ OEM Reference  
 AD K89-4002  
 CL 2798867  
 CL 2780604



Part Number - 3J5800166-68-R  
**Drive R-Motor 24V**

▼ OEM Reference  
 HY 2040658  
 HY 2310528  
 HY 2310528-G  
 YT 730004021  
 YT 730004021-G  
 YT 730024021-AM



Part Number - 3J141102330171-R  
**Drive R-Motor 36-48V**

▼ OEM Reference  
 TY 14110-23301-71  
 TY 14110-23302-71



Part Number - 3J7300310-00-R  
**Drive R-Motor**

▼ OEM Reference  
 YT 7300310-00



Part Number - 3J70-054-00 (New)  
**Drive R-Motor 24/36/48V**

▼ OEM Reference  
 GE 5BC49JB305  
 GE 5BC49JB305B  
 GE 5BC49JB399C  
 TA 70-054-00  
 TA 70-054-03



Part Number - 3J7300120-20-R  
**Drive Motor 24V**

▼ OEM Reference  
 YT 730012020



Part Number - 3J570-363-451-R  
**Steer R-Motor Reach 36V**

▼ OEM Reference  
 RA 570-363-451



Part Number - 3J722197020-R  
**Drive R-Motor 24V**

▼ OEM Reference  
 YT 722197020-R



Part Number - 3J504575231-R  
**Power Steering R-Motor 24V**

▼ OEM Reference  
 HY 8620016  
 YT 504575231



Part Number - 3J70-054-41-R  
**Drive R-Motor**

▼ OEM Reference  
 TA 70-054-41



Part Number - 3J580035626-R  
**Steer R-Motor 36/48V**

▼ OEM Reference  
 HY 8517245  
 YT 580035626



Part Number - 3J2798905-R  
**Drive R-Motor**

▼ OEM Reference  
 CL 2798905



Part Number - 3J1457327 (New)  
**Steer R-Motor 36V**

▼ OEM Reference  
 HY 1457327



Part Number - 3J2819155-R  
**Drive R-Motor 36V**

▼ OEM Reference  
 CL 2819155



Part Number - 3J29210-41H11 (New)  
 Part Number - 3J29210-41H11-R  
 (Rebuilt)  
**Steer R-Motor 36V**  
 ▼ OEM Reference  
 NI 29210-41H11



Part Number - 3J5170726-02-R  
**Steer R-Motor 24V**  
 ▼ OEM Reference  
 YT 517072602



Part Number - 3J97121-31900-R  
**Steer R-Motor 48V**  
 ▼ OEM Reference  
 CT 97121-31900  
 CT 97121-31901



Part Number - 3J2781993-R  
**Steer R-Motor 36/48V**  
 ▼ OEM Reference  
 CL 2781993  
 CL 2388112  
 CL 2809539



Part Number - 370521  
**Aux/Steer Motor**  
 ▼ OEM Reference  
 BT 1020545-500  
 PM 1020545-500  
 RA 1020545-500



Part Number - 370336  
**Hydraulic Power Pump**  
 ▼ OEM Reference  
 YT 580062263



Part Number - 370035  
**Motor Cover (LH as viewed from operator)**  
 ▼ OEM Reference  
 CT A000030530  
 HY 1495764  
 HY 1537410  
 YT 524144503  
 YT 524184972  
 YT 550038924



Part Number - 370034  
**Motor Cover (RH as viewed from operator)**  
 ▼ OEM Reference  
 CT A000030529  
 HY 1495763  
 HY 1537409  
 YT 524144502  
 YT 524184971  
 YT 550038923



Part Number - 370133  
**Brush Kit (Set of 4)**  
 0.485 D x 1.255 W x 1.150 L  
 ▼ OEM Reference  
 RA 570-869-735  
 RA 570-869-735-KIT



Part Number - 370136  
**Brush Kit (Set of 4)**  
 0.495 D x 1.240 W x 1.250 L  
 ▼ OEM Reference  
 YT 582004077



Part Number - 072059  
**Brush**  
 ▼ OEM Reference  
 CT 216035 TY 00591-33330-81 YT 220015891  
 TY 00591-04641-81 TY 00591-60633-81



Part Number - 084547  
**Brush**  
 0.370 D x 0.812 W x 1.157 L  
 ▼ OEM Reference  
 AC 4911481 HY 3052675 TY 00591-32455-81  
 BK 123603 HY 3144749 TY 00591-51463-81  
 CL 906300 HY 800063773 TY 00591-72254-81  
 CL 909819 ME B250407-4 YT 220003593  
 CT 0973796 ME BMP31-214 YT 220025259  
 HY 0286081 OH B-250407-4 YT 220044749  
 HY 3013765 PM 300665-002 YT 220075025



Part Number - 116510  
**Brush Set (4 of 084547)**  
 0.370 D x 0.812 W x 1.157 L  
 ▼ OEM Reference  
 CT 973391 TY 00591-32460-81 YT 220016055  
 OH B-250411-01K TY 00591-60991-81 YT 518264825



Part Number - 021157-001

**Brush**

0.62 D x 1.24 W x 1.34 L

▼ OEM Reference

|               |               |                   |
|---------------|---------------|-------------------|
| BT 306270-000 | KO 302362-000 | TY 00591-03840-81 |
| CL 915595     | PM 300417-000 | TY 00591-33295-81 |
| CL 915933     | PM 300430-000 | TY 00591-56358-81 |
| CL 915934     | PM 301504-000 | YT 220014573      |
| HY 3033063    | PM 302362-000 | YT 220021829      |
| HY 3134050    | PM 306270-000 | YT 220027150      |
| KO 300430-000 | RA 939-194    | YT 220044744      |

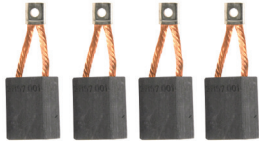

Part Number - 370143

**Brush Kit  
(4 of 021157-001)**

0.62 D x 1.24 W x 1.34 L

▼ OEM Reference

|            |                |                   |
|------------|----------------|-------------------|
| CT 1008664 | MB 1075049     | RA DS225074       |
| CT 1008668 | MB 1142628     | RA DS225081       |
| CT 1009186 | RA 570-236-514 | RA DS228921       |
| CT 1036510 | RA 570-277-515 | TY 00590-04567-71 |
| CT 1075049 | RA 570-295-514 | TY 00590-04575-71 |
| CT 1142628 | RA 570-322-122 | TY 00591-21088-81 |
| HY 3034522 | RA 570-449-513 | TY 00591-42660-81 |
| HY 3126436 | RA 570-604-512 | TY 00591-42677-81 |
| MB 1008664 | RA DS223442    | YT 220016152      |
| MB 1009186 | RA DS224933    | YT 220021620      |



Part Number - 118942

**Brush Set  
(8 of 021157-001)**

0.62 D x 1.24 W x 1.34 L

▼ OEM Reference

|                |                   |                   |
|----------------|-------------------|-------------------|
| HY 3121150     | TY 00590-42110    | TY 00591-23043-81 |
| RA 570-260-511 | TY 00591-42661-81 | YT 220017761      |
| TY 00590-41853 |                   |                   |



Part Number - 074604

**Brush**

0.500 D X 0.625 W x 1.750 L

▼ OEM Reference

|              |                   |                   |
|--------------|-------------------|-------------------|
| BR 16954-007 | HY 800076129      | TY 00591-51482-81 |
| BR 28802-014 | TY 00591-04685-81 | YT 220015861      |
| BR A16954-7  | TY 00591-04685-81 | YT 220016545      |
| CT 215023    | TY 00591-32390-81 | YT 220054093      |



Part Number - 074614

**Brush Set**

▼ OEM Reference

|             |                |                   |
|-------------|----------------|-------------------|
| AC 4906521  | HY 3007446     | TY 00591-30135-81 |
| AC 74906521 | HY 3018819     | TY 00591-51472-81 |
| BJ 003704   | PL 17-63       | YT 129159026      |
| BK 116088   | PL MBD-1418-S  | YT 220008074      |
| BK 15MP9A   | PM 200185      | YT 220023298      |
| CL 883802   | PM EMBD-1418-S | YT 500838400      |
| CT 973039   | RA 570-416-06  | YT 506605800      |
| HY 3001328  | SC 33-11408    | YT 1169404DX      |
| HY 3002686  | SC 41-25683    | YT 1291590-26     |



Part Number - 084304

**Brush Set**

▼ OEM Reference

|            |                |                   |
|------------|----------------|-------------------|
| AC 4907386 | HY 3001857     | SC 33-11417       |
| AC 4912263 | HY 800071662   | TY 00591-03981-81 |
| BK 004327  | PL 17-149      | TY 00591-30634-81 |
| CL 991251  | PL 17-159      | TY 00591-51471-81 |
| HY 241365  | PL 17-183      | YT 220051431      |
| HY 365180  | PL MHR-2012-AS | YT 507413800      |
| HY 3001236 | PL MHR-2012-BS | YT 509016814      |
| HY 3001334 | PL MHR-2012-S  | YT 509016816      |
| HY 3001855 | SC 33-11412    |                   |



Part Number - 370331

**Brush Set (Set of 2)**

▼ OEM Reference

RA 200188/NB



Part Number - 087233

**Brush Set (Set of 8)**

▼ OEM Reference

|              |                |                   |
|--------------|----------------|-------------------|
| BJ 003772    | HY A-120311    | RA 570-433-214    |
| CL 893724    | PL 17-216      | TY 00591-04137-81 |
| CL 999426    | PL 17-227      | TY 00591-14088-81 |
| HY 1198441   | PL 17-87       | TY 00591-31765-81 |
| HY 3006288   | PL MCP-2012-KS | TY 00591-33335-81 |
| HY 3007481   | PL MFH-1012S   | TY 00591-56357-81 |
| HY 3013766   | PL MTD-1012-S  | TY 00591-56436-81 |
| HY 800072005 | RA 570-433-02  | YT 220002716      |
| HY 800108167 |                |                   |



Part Number - 087522

**Brush Set**

0.27 D x 0.76 W x 0.87 L

▼ OEM Reference

|            |                   |                   |
|------------|-------------------|-------------------|
| CL 68587   | PL 17-203         | TY 00591-51456-81 |
| CL 999158  | PL 17-223         | TY 00591-64378-81 |
| CT 215781  | PL MAD-1512-AS    | YT 220023631      |
| HY 0328114 | PL MBD-1512-S     | YT 220051433      |
| HY 328114  | PM 200188         | YT 509016821      |
| HY 0328914 | PM EMBD-1512-S    | YT 518264883      |
| HY 3002679 | TY 00591-32452-81 | YT 5090168-21     |
| HY 3053018 | TY 00591-42281-81 |                   |



Part Number - 090276

**Brush Set (Set of 4)**

0.500 D x 1.265 W x 1.376 L

▼ OEM Reference

|           |                |                   |
|-----------|----------------|-------------------|
| CL 892234 | HY 228615      | PM EMEA-1012BS    |
| CL 905878 | HY 288201      | RA 570-437-02     |
| CL 988646 | PL MEA-1012AS  | RA 570-437-211    |
| CL 998642 | PM EEME-1012CS | TY 00591-42276-81 |
| CL 998646 |                |                   |





**Part Number - 087393**  
**Brush Set (Set of 8)**  
 0.550 D x 1.000 W x 1.385 L  
 ▼ OEM Reference  
 PL MTE-1012S  
 YT 220041853



**Part Number - 093585**  
**Brush Set (Set of 4)**  
 0.405 D x 0.855 W x 1.430 L  
 ▼ OEM Reference  
 HY 0360804 TY 00591-05090-81  
 HY 3012559 TY 00591-33328-81  
 HY 800076793 TY 00591-60732-81



**Part Number - 370530**  
**Brush Set (4)**  
 ▼ OEM Reference  
 RA 570-869-551



**Part Number - 094843**  
**Brush Set (Set of 4)**  
 ▼ OEM Reference  
 AC 4914589 HY 3006290 PM 200248  
 AC 4916087 PL 17-188 PM EMGQ-2012-BS  
 BR 28829-059 PL 17-193 RA 570-205-04  
 CL 906578 PL 17-235 RA 570-436-04  
 CL 998234 PL MGQ-2012-AS TY 00591-32476-81  
 CL 1819404 PL MGQ-2012-BS YT 5090168-19  
 CT 973515 PL MGQ-2012-S  
 CT 973516 PM 200021



**Part Number - 100730**  
**Brush Set (Set of 4)**  
 ▼ OEM Reference  
 CT 928965 RA 570-215-219 TY 00591-32471-81  
 CT 973756 RA 570-240-115 TY 00591-42278-81  
 CT 1036558 RA 570-241-114 TY 00591-52520-81  
 HY 360809 TY 00591-04168-81

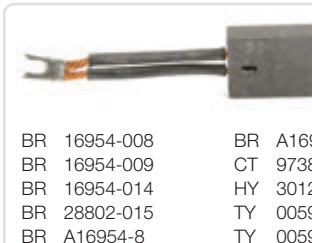

**Part Number - 103842**  
**Brush**  
 ▼ OEM Reference  
 BR 16954-008 BR A16954-9 TY 00591-51464-81  
 BR 16954-009 CT 973863 TY 00591-56396-81  
 BR 16954-014 HY 3012562 TY 220003254  
 BR 28802-015 TY 00591-30254-81 YT 220016358  
 BR A16954-8 TY 00591-33355-81 YT 220023635



**Part Number - 104868**  
**Brush**  
 0.500 D x 0.625 W x 1.445 L  
 ▼ OEM Reference

- |               |                   |                   |
|---------------|-------------------|-------------------|
| BK 129964     | HY 3007484        | TY 00591-52523-81 |
| BR 16954-015  | HY 3012560        | YT 220007694      |
| BR 16954-015S | HY 3031310        | YT 220007703      |
| BT 300300-000 | HY 3057512        | YT 220013162      |
| CL 1893222    | HY 3131910        | YT 220023510      |
| CT 216357     | HY 3144747        | YT 220037512      |
| DS P221-1043  | PM 300300000      | YT 220044747      |
| GE 625A649AK5 | TC FA72E1-05672   | YT 220075082      |
| HY 1309377    | TY 00591-04239-81 | YT 504230259      |
| HY 1309385    | TY 00591-32456-81 | YT 504237261      |
| HY 1346277    | TY 00591-33332-81 | YT 518805656      |
| HY 1376980    | TY 00591-43681-81 | YT 580028320      |
| HY 3007439    | TY 00591-51466-81 |                   |



**Part Number - 073854**  
**Brush**  
 0.375 D X 0.750 W x 0.786 L  
 ▼ OEM Reference  
 TY 00591-04670-81 TY 00591-60651-81  
 TY 00591-33331-81 YT 220016331



**Part Number - 370275**  
**Brush Set (Set of 4)**  
 0.370 D x 0.615 W x 1.130 L  
 ▼ OEM Reference  
 TY 14543-U1090-71



**Part Number - 104888**  
**Brush Set (Set of 8)**  
 0.548 D x 0.997 W x 1.500 L  
 ▼ OEM Reference  
 CT 1049941 TY 00591-04241-81 TY 00591-52524-81  
 CT 1049942 TY 00591-32457-81 YT 220010146  
 RA 570-236-114 TY 00591-42283-81 YT 220015020



**Part Number - 107304**  
**Brush Set**  
 ▼ OEM Reference  
 HY 800075206  
 TY 00591-20030-81  
 TY 00591-33326-81  
 TY 00591-60552-81



**Part Number - 107312**  
**Brush Set**  
 ▼ OEM Reference  
 BR 27327-215  
 BR 27327-216  
 TY 00591-52527-81  
 YT 220015280



Part Number - 109953

**Brush**  
0.500 D x 1.250 W x 1.625 L

▼ OEM Reference

|                   |                   |              |
|-------------------|-------------------|--------------|
| HY 1335385        | TY 00591-63177-81 | YT 580011010 |
| HY 1462472        | TY 220013161      |              |
| TY 00591-33292-81 | TY 220026265      |              |



Part Number - 113328

**Brush Set (Set of 4)**  
0.62 D x 1.25 W x 1.34 L

▼ OEM Reference

|                |                   |              |
|----------------|-------------------|--------------|
| HY 800075249   | RA DS227871       | YT 220015628 |
| RA 570-240-229 | TY 00591-04291-81 | YT 220023517 |
| RA 570-252-517 | TY 00591-33327-81 |              |
| RA 570-447-513 | TY 00591-52528-81 |              |



Part Number - 110200

**Brush**  
0.500 D x 1.125 W x 1.450 L

▼ OEM Reference

|            |                   |                   |
|------------|-------------------|-------------------|
| BG 030-807 | HY 3054719        | TY 00591-60319-81 |
| HY 362118  | KO 3BA-18-25490   | TY 14344-U1090-71 |
| HY 389722  | TY 00591-04288-81 | YT 220044108      |
| HY 2013288 | TY 00591-32469-81 |                   |



Part Number - 116363

**Brush Set (4 of 110200)**  
0.500 D x 1.125 W x 1.450 L

▼ OEM Reference

|                   |
|-------------------|
| TY 00591-33334-81 |
| TY 00591-56409-81 |
| YT 220018823      |



Part Number - 113498

**Brush**

▼ OEM Reference

|              |
|--------------|
| HY 3121436   |
| YT 220018132 |



Part Number - 113652

**Brush Set (Set of 4)**  
0.628 D x 1.240 W x 1.300 L

▼ OEM Reference

|                   |
|-------------------|
| TY 00591-42668-81 |
| YT 220015245      |

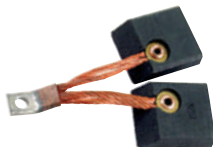

Part Number - 370745

**Brush-Drive Motor (Set of 2, 1 Pr)**  
0.500 D x 1.122 W x 1.500 L

▼ OEM Reference

|                 |                   |                   |
|-----------------|-------------------|-------------------|
| AC 3BB-18-24810 | HY 328761         | TY 00591-51469-81 |
| AC 3BB-18-A3240 | HY 332780         | YT 220016992      |
| AC 3BB-18-A3241 | KO 3BB-18-24810   | YT 220031795      |
| AC 4967968      | KO 3BB-18-A3240   | YT 220034493      |
| AC 8772171      | KO 3BB-18-A3241   | YT 220070190      |
| CL 332780       | MB 973809         | YT 220070226      |
| CL 448400       | MB 973869         | YT 900010215      |
| CT 973809       | TY 00591-07693-81 |                   |
| CT 973869       | TY 00591-32468-81 |                   |



Part Number - 114502

**Brush Set (Set of 4)**  
0.488 D x 1.242 W x 1.300 L

▼ OEM Reference

|              |
|--------------|
| HY 3033370   |
| YT 220015301 |



Part Number - 370273

**Brush Set (4 pairs)**  
0.495 D x 2.235 W x 1.375 L

▼ OEM Reference

|            |
|------------|
| DX 1402083 |
|------------|



Part Number - 114541

**Brush Set (Set of 8)**

▼ OEM Reference

|              |
|--------------|
| HY 3144797   |
| YT 220044797 |



Part Number - 111768

**Brush**  
0.625 D x 1.125 W x 1.750 L

▼ OEM Reference

|                   |                 |                   |
|-------------------|-----------------|-------------------|
| CT 973810         | HY 1386170      | TY 00591-06234-81 |
| CT 9722002800     | KO 3BB-17-A3340 | TY 00591-32462-81 |
| GE 36A291746AC002 | MB 9722002800   | TY 00591-60320-81 |
| GE 36A291746ACP02 | MB SE000168     | TY 14147-U2090-71 |
| GM 0105-5919      | NI 29142-8G201  | YT 220070227      |
| HY 364674         | TC FA72G1-05142 | YT 520045399      |



Part Number - 370271

**Brush Set (Set of 8)**  
0.500 D x 1.555 W x 1.500 L

▼ OEM Reference

|                   |
|-------------------|
| TY 14351-21440-71 |
|-------------------|



**Part Number - 370272**  
**Brush Set (Set of 4)**  
 0.625 D x 0.960 W x 1.300 L

▼ OEM Reference  
 TY 00590-41782-71



**Part Number - 370274**  
**Brush Set (Set of 4)**  
 0.625 D x 1.240 W x 1.305 L

▼ OEM Reference  
 CT 97020-10170  
 MB 97020-10170



**Part Number - 114671**  
**Brush Set (Set of 4)**

▼ OEM Reference  
 RA 570-235-513  
 RA 570-317-515  
 RA 570-383-512  
 YT 220018821



**Part Number - 111136**  
**Brush Set (Set of 4)**

▼ OEM Reference  
 RA 570-427-516  
 TY 00591-42667-81  
 YT 220029734



**Part Number - 087713**  
**Brush Set (Set of 8)**

▼ OEM Reference  
 PL 17-218  
 PL MEA-1012BS  
 TY 00591-30635-81  
 TY 00591-60718-81



**Part Number - 116961**  
**Brush Set (Set of 8)**  
 0.628 D x 1.247 W x 1.500 L

▼ OEM Reference  
 YT 220043258



**Part Number - 118913**  
**Brush Set (Set of 4)**

▼ OEM Reference

|             |                |                   |
|-------------|----------------|-------------------|
| CT 1092493  | MB 1203335     | RA DS232755       |
| CT 1203335  | MB NA012195    | TY 00590-04748-71 |
| CT NA012195 | MB NA013903    | TY 00591-42678-81 |
| CT NA013903 | RA 570-268-515 | YT 220018826      |
| HY 3122590  | RA 570-316-516 | YT 220029109      |
| HY 3137109  | RA 570-334-512 |                   |
| MB 1202335  | RA 570-360-511 |                   |



**Part Number - 125020**  
**Brush Set**

▼ OEM Reference  
 HY 3135864  
 YT 220036158



**Part Number - 370149**  
**Brush w/BWI (Set of 2)**

▼ OEM Reference  
 HY 1507462  
 YT 580029663



**Part Number - 370150**  
**Brush**

▼ OEM Reference

|                |                |              |
|----------------|----------------|--------------|
| CL 2307487     | HY 2307487     | YT 520344803 |
| CT A0000-13061 | MB A0000-13061 | YT 582004027 |



**Part Number - 370151**  
**Brush Kit (Set of 4)**

▼ OEM Reference

|                |                   |              |
|----------------|-------------------|--------------|
| CT 07125-06700 | MB 07125-06700    | YT 580007602 |
| CT 97125-06700 | MB 97125-06700    |              |
| HY 1459684     | TY 14543-U1160-71 |              |



**Part Number - 370152**  
**Brush (Set of 2)**

▼ OEM Reference

|                   |                   |              |
|-------------------|-------------------|--------------|
| CT 1058341        | HY 3057511        | YT 220037511 |
| GE 36A291850AHP02 | HY 3144107        | YT 220044107 |
| GE 36A291850AHP03 | HY 3144124        | YT 220044124 |
| GM 0105-6637      | MB 1058341        | YT 220075064 |
| HY 366090         | NI 29142-8G000    | YT 504229255 |
| HY 1312816        | TY 00591-06236-81 | YT 504229274 |
| HY 3056409        | TY 00591-56410-81 | YT 519466014 |



**Part Number - 100358**  
**Brush & Lug Assembly**

▼ OEM Reference  
 TY 00591-42669-81



**Part Number - 021158-001**  
**Brush**

0.49 D X 0.97 W x 1.30 L

▼ OEM Reference  
 YT 220026664



Part Number - 370237  
**Brush Set (1 Piece)**

▼ OEM Reference  
LI 0009718156



Part Number - 370245  
**Brush**

▼ OEM Reference  
LI 0009718189

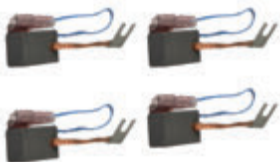

Part Number - 370238  
**Brush Kit (Set of 4)**

▼ OEM Reference  
HY 1459693  
YT 580007606

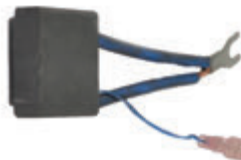

Part Number - 370246  
**Brush Pump Motor**

▼ OEM Reference  
TY 14352-21440-71  
TY 14111-F1090-71



Part Number - 370239  
**Brush Kit (Set of 4)**

▼ OEM Reference  
HY 1461570  
YT 580010369



Part Number - 370247  
**Brush Set (Set of 4)**

0.880 D x 0.880 W x 0.880 L  
▼ OEM Reference  
RA 1016523-215



Part Number - 370240  
**Brush**

▼ OEM Reference  
HY 1502113  
YT 580027030



Part Number - 370248  
**Brush Set (1 Pair)**

0.280 D x 0.880 W x 0.880 L  
▼ OEM Reference  
RA 570-237-218



Part Number - 370241  
**Brush Set (Set of 2)**

▼ OEM Reference  
HY 2034133  
YT 582004043



Part Number - 370042  
**Drive Motor Brush Set with Springs (Set of 4)**

0.350 D x 0.5000 W x 0.950 L  
▼ OEM Reference  
HY 1506791  
YT 580029149



Part Number - 370242  
**Brush Set (1 Pair)**

▼ OEM Reference  
HY 1389604  
YT 723791145



Part Number - 370154  
**Brush & Spring**

▼ OEM Reference  
CL 912404 TY 00591-56450-81 YT 521558001  
HY 3039096 TY 220017107 YT 521558002  
PM 202028 TY 519578814  
TY 00591-33323-81 TY 519578824

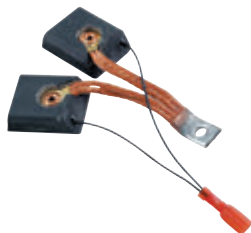

Part Number - 370243  
**Brush (1 Pair)**

▼ OEM Reference  
CT 97120-06300  
HY 374531  
MB 97120-06300  
TY 518804691  
TY 14341-U2090-71



Part Number - 125789  
**Brush & Spring Set**

▼ OEM Reference  
BK 152156 CL 929325 TY 00590-40635-71  
BR 27327-287 HY 1463273 YT 519616815  
BR 27327-293 RA 560-213-07  
BR 69580-FS000 RA 850-139-013



Part Number - 370244  
**Brush**

▼ OEM Reference  
TY 14181-11480-71  
TY 14112-12240-71



**Part Number - 084548**  
**Ring Brush Assembly**

▼ OEM Reference

|            |                   |              |
|------------|-------------------|--------------|
| AC 4911482 | HY 3019763        | YT 504223284 |
| CL 906294  | TY 00591-30163-81 | YT 518264803 |
| HY 0286080 | YT 220002204      | YT 518264826 |
| HY 3017806 | YT 220079575      | YT 518264835 |



**Part Number - 107090**  
**Brush Spring Set (Set of 4)**

▼ OEM Reference

|            |                   |                   |
|------------|-------------------|-------------------|
| CL 7004330 | PL 50-525         | TY 00591-64383-81 |
| CT 1036520 | RA 570-240-119    | YT 220007922      |
| CT 1050062 | RA 570-249-213    | YT 220034592      |
| DW A200836 | TY 00591-42287-81 |                   |



**Part Number - 020018**  
**Brush Box Assembly**

▼ OEM Reference

|            |                   |                   |
|------------|-------------------|-------------------|
| BK 709652  | HY 360810         | TY 00591-42335-81 |
| CL 910218  | PL 36-1175        | TY 00591-64431-81 |
| CL 913225  | PM 200065         | YT 220029198      |
| CL 7004338 | RA 570-215-216    | YT 220054705      |
| CT 1036517 | TY 00591-17521-81 |                   |



**Part Number - 076481**  
**Brush Spring Set (Set of 4)**

▼ OEM Reference

|              |                   |                   |
|--------------|-------------------|-------------------|
| AC 1009710   | CL 6517648        | TY 00591-51366-81 |
| AC 4906486   | CT 311022         | YT 015948600      |
| AC 71009710  | CT 1009189        | YT 023403100      |
| AC 74906486  | HY 0055613        | YT 023403400      |
| BK 993459    | HY 0238760        | YT 052041100      |
| BK 12MP32    | HY 1198105        | YT 056210400      |
| BK 94MBY1    | HY A-98629        | YT 058786800      |
| BK EP311     | PL 50-263         | YT 066158200      |
| BK EP311A    | PL MZ-19-S        | YT 129159024      |
| BK EP477     | PM 200305         | YT 220051365      |
| BR 27327-038 | PM EMZ-19S        | YT 505104800      |
| BR 27327-199 | RA 560-010-12     | YT 506273800      |
| BR 27793-011 | RA 570-417-08     | YT 1169404DH      |
| CL 68866     | SC 33-11452       | YT 6066614AC      |
| CL 893682    | TY 00591-41490-81 |                   |



**Part Number - 100729**  
**Brush Plate**

▼ OEM Reference  
RA 570-240-116

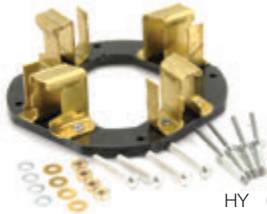

**Part Number - 082661**  
**Brush Holder**

▼ OEM Reference

|             |              |                   |
|-------------|--------------|-------------------|
| AC 74912772 | HY 0275047   | RA 570-413-06     |
| BK 115114   | HY 0317714   | RA 570-415-18     |
| CL 905799   | HY 1199508   | SC 33-11361       |
| CL 906182   | HY 3052917   | SC 33-11368       |
| CL 991548   | PL 90-2710   | TY 00591-35188-81 |
| CL 994644   | PL MEE-1164  | YT 220051425      |
| CL 999470   | PM 200148    | YT 509015804      |
| CT 216387   | PM E-90-2495 | YT 511274800      |
|             | PM E-90-2596 |                   |
|             | PM E-90-2710 |                   |



**Part Number - 087398**  
**Brush Spring**

▼ OEM Reference

|            |                 |                   |
|------------|-----------------|-------------------|
| AC 4911483 | HY 0286082      | PM 300665-001     |
| AC 4968002 | HY 3002482      | TY 00591-03656-81 |
| BK 112546  | HY 3003312      | TY 00591-32165-81 |
| CL 906301  | HY 3052676      | TY 00591-51371-81 |
| CL 909820  | KO 3BB-19-24560 | YT 220051868      |
| CL 915801  | ME B240501      | YT 504228298      |
| CT 0973392 | OH B240501      | YT 518264804      |



**Part Number - 087884**  
**Brush Spring**

▼ OEM Reference

|            |                |                   |
|------------|----------------|-------------------|
| BK 129963  | RA 570-115-115 | TA 85-412-00      |
| CL 7003964 | RA 570-445-214 | TY 00591-32166-81 |



**Part Number - 074606**  
**Brush Spring**

▼ OEM Reference

|              |                   |              |
|--------------|-------------------|--------------|
| BR 22393-016 | HY 800076131      | YT 054038000 |
| CL 7003934   | TY 00591-32135-81 | YT 220017582 |
| HY 3012785   | TY 00591-56262-81 |              |

## Motor and Hydraulic



Part Number - 125918

### Brush Spring

▼ OEM Reference

|              |                   |                   |
|--------------|-------------------|-------------------|
| CL 915596    | HY 800071351      | TY 00591-42623-81 |
| HY 3145024   | PM 300418-000     | YT 220028029      |
| HY 800017481 | TY 00591-03828-81 | YT 220045024      |



Part Number - 078496

### Brush Spring Set (Set of 4)

▼ OEM Reference

|              |                |                   |
|--------------|----------------|-------------------|
| AC 4905999   | HY 3001792     | RA 570-414-08     |
| BJ 003711    | HY A-134258    | RA 570-415-10     |
| BJ 900136    | HY A-144545    | SC 33-11456       |
| BK 108782    | ME MGP18SS     | TC 2002410        |
| BK 993956    | ME SMP12-470   | TC EMGP18SS0      |
| BR 28829-058 | ME SMP12-472   | TY 00591-41515-81 |
| CL 908767    | PL 50-368      | TY 00591-51363-81 |
| CL 980767    | PL MGP-18-SS   | YT 220023441      |
| CT 0973393   | PM 200241      | YT 220051423      |
| HY 1144545   | PM 30556-00    | YT 509014801      |
| HY 1198953   | PM EMGP-18-SS  |                   |
| HY 1199363   | RA 570-236-113 |                   |



Part Number - 370144

### Seal

▼ OEM Reference

|              |                   |              |
|--------------|-------------------|--------------|
| CL 7003816   | RA 530-615        | WM 20-P-68   |
| CT GS0000888 | TY 00591-41247-81 | WM 21-H-3325 |
| CT 1062983   | TY 00591-54596-81 | WM 30-P-575  |
| HY 3013840   | WM 20-H-1160      | WM 403692-D  |
| MB GS0000888 | WM 20-P-358       | YT 220003634 |
| RA DS225024  | WM 20-P-4191      | YT 220016555 |



Part Number - 370157

### Seal

▼ OEM Reference

|            |                   |                   |
|------------|-------------------|-------------------|
| BK 001383  | HY 3050644        | TY 00591-32048-81 |
| BK 12AL213 | HY 3131031        | TY 00591-58736-81 |
| CL 7003779 | KO 37B-7AV-1211   | YT 220006678      |
| CT 215622  | LI 001383         | YT 220022631      |
| HY 0046671 | TY 00591-00174-81 |                   |



Part Number - 370529

### Oil Seal

▼ OEM Reference

|               |               |                   |
|---------------|---------------|-------------------|
| AC 8735227    | HY 3134578    | MB NA57010        |
| AC OP03000139 | KO 8735227    | RA 570-262-218    |
| CT 1134235    | KO OP03000139 | RA 570-262-518    |
| CT 1135235    | MB 1134235    | RA 570-279-511    |
| CT A000018358 | MB 1135235    | RA DS223622       |
| CT NA012923   | MB A000018358 | TY 00591-72102-81 |
| CT NA57010    | MB NA012923   | YT 220027809      |



Part Number - 370056

### Fitting

▼ OEM Reference

|              |
|--------------|
| HY 2309185   |
| YT 504114800 |



Part Number - 370208

### Reservoir

▼ OEM Reference

|               |                |                   |
|---------------|----------------|-------------------|
| CL 3798160    | HY 3038235     | RA 870-903        |
| CL 8027617    | JU 27602230    | TY 00591-35395-81 |
| CL 6035-10870 | JU 27623760    | TY 00591-58049-81 |
| CT 27602230   | MB 0802082     | YT 220012366      |
| CT 27623760   | MB 802082      | YT 220017463      |
| CT 398724     | MB 27602230    | YT 252370600      |
| CT 802082     | MB 27623760    | YT 580006015      |
| HY 1300155    | MB W505010139  | YT 580021039      |
| HY 1489805    | MB W5050-10139 |                   |
| HY 2305052    | NI 6035-10870  |                   |

## Cylinders/Seal Kits



Part Number - 370202

### Ram Assembly Cylinder

▼ OEM Reference  
RA 540-091-300



Part Number - 370536

### Master Cylinder

▼ OEM Reference  
RA 828-900-096-102



Part Number - 370199

### Master Cylinder

▼ OEM Reference

|               |                    |                    |
|---------------|--------------------|--------------------|
| BR B-19121-4  | HY 3038442         | RA 824-900-003-002 |
| BR B19121-4   | HY 3121012         | RA 824-900-003-003 |
| BR D-19121-14 | RA 1009641         | RA 870-614-100     |
| BR 19121-004  | RA 1011257-100     | RA 870-614         |
| CL 7001018    | RA 820-001-687     | TY 00591-21103-81  |
| CT NA019019   | RA 820-001-688     | TY 00591-30176-81  |
| CT 1036894    | RA 821-900-040-001 | TY 00591-30243-81  |
| DS P261-0013  | RA 821-900-040-002 | TY 00591-52201-81  |
| GM 0246-M9XA  | RA 821-900-040-1   | TY 00591-53118-81  |
| HY 3007219    | RA 821-900-040     | YT 220007708       |
| HY 3007688    | RA 824-900-003-001 | YT 220018189       |



Part Number - 370515

### Tilt Cylinder Assembly

▼ OEM Reference  
RA 540-084



Part Number - 370029

### Seal Kit Lift Cylinder

▼ OEM Reference  
HY 2307177 TY 00591-42560-81  
HY 3054871 TY 00591-60896-81



Part Number - 370204

### Master Cylinder

▼ OEM Reference  
RA 870-896-002  
RA 870-896-004



Part Number - 370537

### Seal

▼ OEM Reference  
CT 1036492 RA 530-633 YT 220016032  
HY 3013928 RA DS232952  
MB 1036492 TY 00591-76028-81



Part Number - 370203

### Master Cylinder

▼ OEM Reference  
MB A0000-30255  
RA 870-630-100



Part Number - 370558

### Seal Kit

▼ OEM Reference  
BT 530-732-003 RA 530-732-003  
PM 530-732-003 RA 530-732/003



Part Number - 370525

### Master Cylinder

▼ OEM Reference  
RA 870-896-001  
RA 870-896-003



Part Number - 370489

### Seal Kit

▼ OEM Reference  
TY 04652-U2040-71  
TY 04652-U2070-71



Part Number - 370106

**Roller**

▼ OEM Reference

- |             |                |                   |
|-------------|----------------|-------------------|
| CT 1051077  | RA 123-001-382 | TY 00591-70714-81 |
| HY 3034352  | RA 828-005-498 | YT 220015913      |
| RA DS223092 | RA 828-006-726 |                   |



Part Number - 104164-007

**Solenoid Coil**

▼ OEM Reference

- YL 580038835

⚠WARNING: Cancer and reproductive harm - [www.P65Warnings.ca.gov](http://www.P65Warnings.ca.gov)



Part Number - 360038-271

**Bumper (2 Required)**

▼ OEM Reference

- HY 2050084  
YT 524149326



Part Number - 351096-321

**Relay**

▼ OEM Reference

- |               |              |                   |
|---------------|--------------|-------------------|
| CL 448350     | MB NA010027  | RA 1-100-075      |
| CT GS00-00035 | RA 0055111CE | RA DS223172       |
| CT NA010027   | RA 0055276CE | TY 00591-75890-81 |
| MB GS00-00035 | RA 1-100-067 |                   |



Part Number - GN100195GT

**Replacement Power Cord AC**

- 6' 7" L
- 300v
- 15 amp, 13 amp plug

▼ OEM Reference  
DEKA IMP-9412



Part Number - 370073

**Horn Contact**

▼ OEM Reference

- TY 57413-22500-71  
TY 57413-22500



Part Number - 142669

**Replacement Power Cord**

- 10 ft. long
- 300v
- 15 amp, 15 amp plug



Part Number - 370079

**Horn Contact**

▼ OEM Reference

- TY 57415-23600-71  
YT 220034250



Part Number - 126711

**Replacement Charger Cord AC**

- 8.2 ft. long
- 125VAC
- 15 amp

▼ OEM Reference  
DEKA IMP-9409  
DEKA SA4081



Part Number - 370341

**Horn Contact**

▼ OEM Reference

- TY 57457-13500-71



Part Number - 396351

**Replacement Power Cord AC**



Part Number - 398000-067

**Horn Plunger**

▼ OEM Reference

- CT 91354-12600  
MB 91354-12600  
RA DS235362  
YT 220034070



Part Number - 396354

**Replacement Power Cord**

- 18" of straight cord, female end to spiral cord
- For Zivan charger

▼ OEM Reference  
GNB V04ZIVANPLUG



Part Number - 370062

**Horn Contact - Ring**

▼ OEM Reference

- TY 45123-23600-71



Part Number - 396350

**Replacement Power Cord**

- 12" of straight cord on either side of 12" constricted spiral cord (60" total) length.
- For Zivan charger

▼ OEM Reference  
GNB V04SPRLCORD



Part Number - 370083

**Horn Contact - Ring**

▼ OEM Reference

- |                   |                   |              |
|-------------------|-------------------|--------------|
| HY 3141503        | TY 45112-22001-71 | YT 220041503 |
| TY 45112-22000-71 | TY 45112-22002-71 |              |





**Part Number - 370084**  
**Horn Contact - Ring**  
 ▼ OEM Reference  
 HY 3122944  
 TY 45111-23000-71  
 YT 220018881



**Part Number - 370063**  
**Horn Contact - Spring**  
 ▼ OEM Reference  
 TY 45124-23600-71



**Part Number - 398000-153**  
**Horn Contact Case**  
 ▼ OEM Reference  
 CT A0000-28794  
 MB A0000-28794  
 YT 45120-12240-71



**Part Number - 370081**  
**Horn Plate**  
 ▼ OEM Reference  
 CT A000014902  
 TY 00591-71832-81  
 TY 45113-22500-71  
 YT 220019121



**Part Number - 370080**  
**Horn Plate**  
 ▼ OEM Reference  
 HY 3003064  
 TY 45116-20540-71  
 TY 45116-20540  
 YT 220076629



**Part Number - 380030-203**  
**Horn Contact**  
 ▼ OEM Reference  
 CT 91A06-09700  
 MB 91A06-09700  
 NI 25569-FK000



**Part Number - 380030-196**  
**Horn Spring**  
 ▼ OEM Reference  
 NI 48425-FJ100



**Part Number - 370064**  
**Horn Contact - Spring**  
 ▼ OEM Reference  
 TY 57414-22500-71



**Part Number - 370082**  
**Horn Spring**  
 ▼ OEM Reference  
 TY 45115-22500-71  
 YT 220018884



**Part Number - 370085**  
**Horn Spring**  
 ▼ OEM Reference  
 TY 57414-23600-71



**Part Number - 370342**  
**Horn Spring**  
 ▼ OEM Reference  
 TY 57458-13500-71



**Part Number - 398000-066**  
**Horn Spring**  
 ▼ OEM Reference  
 BR NF91354-05600  
 CT 91354-05600  
 MB 91354-05600  
 NI NF91354-05600



**Part Number - 370086**  
**Horn Spring**  
 ▼ OEM Reference  
 HY 3046967  
 TY 45112-20540-71  
 YT 220010769



**Part Number - 398000-064**  
**Horn Spring**  
 ▼ OEM Reference  
 BR NF91255-01800  
 BT DS237820  
 CT 1015387  
 CT 91255-01800  
 CT 9125501800  
 HY 3120942  
 MB 1015387  
 MB 91255-01800  
 MB 9125501800  
 NI NF91255-01800  
 PM DS237820  
 RA DS237820  
 YT 220019513



**Part Number - 370506**  
**Switch - Horn Button (Universal)**  
 ▼ OEM Reference

|             |             |                   |
|-------------|-------------|-------------------|
| AC 652426   | HY 1194764  | RA 590-095        |
| AC D1972351 | HY 3007556  | RA 600-927        |
| AC DU1960   | HY 3012820  | RA 812-001-256    |
| BK SW61     | HY 3143153  | TY 00591-07608-81 |
| CL 445653   | HY A3178    | TY 00591-41812-81 |
| CL 7004244  | KO 652426   | TY 00591-41987-81 |
| CL 857259   | KO D1972351 | TY 00591-51942-81 |
| CT 215589   | KO DU1960   | TY 00591-57432-81 |
| CT 215591   | LI SW61     | YT 051244600      |
| CT 973024   | MB 215589   | YT 065242600      |
| CT 973029   | MB 215591   | YT 220002759      |
| HY 0003178  | MB 973024   | YT 220043153      |
| HY 0012820  | MB 973029   | YT 610196100      |



**Part Number - 380700-007**  
**Horn Switch**  
 ▼ OEM Reference

|                |                |                   |
|----------------|----------------|-------------------|
| BT 1-150-429   | PM 1-150-429AM | RA DS228500       |
| BT 1-150-429AM | PM DS228500    | TY 00590-02628-71 |
| BT DS228500    | RA 1-150-429   |                   |
| PM 1-150-429   | RA 1-150-429AM |                   |



**Part Number - 370756**  
**Switch - Emergency Disconnect/Stop**

▼ OEM Reference

- |            |           |                   |
|------------|-----------|-------------------|
| HY 2306364 | HY 294000 | TY 00591-74634-81 |
| HY 283984  | HY 294009 | YT 504575269      |



**Part Number - 370554**  
**Spring**

- ▼ OEM Reference
- |             |
|-------------|
| RA 830-340  |
| RA 830-347  |
| RA DS224394 |



**Part Number - 360038-277**  
**Spring**

- ▼ OEM Reference
- |          |
|----------|
| AC 46490 |
| BT 46490 |
| KO 46490 |
| PM 46490 |
| RA 46490 |



**Part Number - 370206**  
**Packing Back-up Plug**

- ▼ OEM Reference
- |            |                |                   |
|------------|----------------|-------------------|
| CL 7003604 | MB 1063129     | TY 00591-40804-81 |
| CT 1063129 | RA 623-005-050 | YT 220003944      |
| HY 3015316 | RA DS232945    |                   |



**Part Number - 370503**  
**Return Spring**

- ▼ OEM Reference
- |               |
|---------------|
| RA 312855-001 |
|---------------|



**Part Number - 370146**  
**AC Cord & Plug**

- ▼ OEM Reference
- |              |
|--------------|
| YT 644087802 |
|--------------|



**Part Number - 370305**  
**Proximity Switch Assembly**

- ▼ OEM Reference
- |            |
|------------|
| RA 1031332 |
|------------|

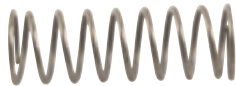

**Part Number - 370504**  
**Spring**

- ▼ OEM Reference
- |            |
|------------|
| BT 1036742 |
| PM 1036742 |
| RA 1036742 |



**Part Number - 370440**  
**Spring Side Tracker**

- ▼ OEM Reference
- |                |
|----------------|
| BR 48488-FS007 |
| NI 48488-FS007 |



**Part Number - 370539**  
**Spring**

▼ OEM Reference

- |                |                   |                   |
|----------------|-------------------|-------------------|
| CL 7003962     | MB A0000-00164    | TY 00591-53119-81 |
| CL 7004016     | RA 830-174        | TY 00591-70167-81 |
| CT A0000-00164 | RA 830-229        | YT 220001756      |
| HY 3005737     | TY 00591-30964-81 |                   |
| HY 3033885     | TY 00591-32163-81 |                   |



**Part Number - 380700-004**  
**Temp Sensor**

▼ OEM Reference

- |                    |                    |                    |
|--------------------|--------------------|--------------------|
| BT 308123-000      | HY 3145025         | RA 828-003-420/002 |
| BT 828-003-420/002 | MB 1051330         | RA 828-003-420/004 |
| BT 828-003-420/004 | PM 308123-000      | RA 828-003-420/006 |
| BT 828-003-420/006 | PM 828-003-420/002 | RA DS224081        |
| BT DS224081        | PM 828-003-420/004 | TY 00591-76106-81  |
| CT 1051330         | PM 828-003-420/006 | YT 220034275       |
| GM 0256-04HF       | PM DS224081        | YT 220045025       |
| HY 3135188         | RA 308123-000      |                    |



**Part Number - 370147**  
**Wire Harness**

- ▼ OEM Reference
- |              |
|--------------|
| HY 2063768   |
| YT 524141442 |
| YT 580043706 |



**Part Number - 370553**  
**Spring**

▼ OEM Reference

- |            |             |                   |
|------------|-------------|-------------------|
| CT 1055730 | MB 1055730  | TY 00591-21098-81 |
| CT 219528  | MB 219528   | YT 220019545      |
| HY 3039498 | RA 830-050  | YT 220024344      |
| HY 3132744 | RA DS232536 |                   |



**Part Number - 370057**  
**Wire Harness**

- ▼ OEM Reference
- |              |
|--------------|
| YT 524149943 |
| HY 2047806   |



Part Number - 370026

**Wiring Harness Assembly**

▼ OEM Reference  
HY 2307607  
YT 503918700



Part Number - 370313

**Harness**

▼ OEM Reference  
RA 307566-000



Part Number - 370340

**Insulator**

▼ OEM Reference  
TY 14213-21400-71



Part Number - 370221

**Bolt**

▼ OEM Reference

|             |             |                |
|-------------|-------------|----------------|
| CT 51023801 | JU 51058719 | MB W2050-13429 |
| CT 51058719 | MB 51023801 | MB W2050-13534 |
| JU 51023801 | MB 51058719 |                |



Part Number - 370051

**Battery Cover Knob**

▼ OEM Reference  
HY 2033545  
YT 721528104



Part Number - 370333

**Symbol Plate**

▼ OEM Reference

|              |           |                |
|--------------|-----------|----------------|
| BT 171583    | PM 171583 | RA 851-201-178 |
| HY 800140840 | RA 171583 |                |



Part Number - 370335

**Lever Plate**

▼ OEM Reference  
CL 1808135



Part Number - 370343

**Lever Display**

▼ OEM Reference  
YT 582005136



Part Number - 370069

▼ OEM Reference

|                |                |                   |
|----------------|----------------|-------------------|
| NI 29327-15K00 | RA 1-125-014   | RA DS223474       |
| NI 29327-15K01 | RA 828-900-101 | TY 90891-03006-71 |



Part Number - 351096-319

**Transistor Kit**

▼ OEM Reference  
RA 1133904



Part Number - 370306

**Washer**

▼ OEM Reference

|             |             |
|-------------|-------------|
| AC 11857-20 | PM 11857-20 |
| BT 11857-20 | RA 11857-20 |
| KO 11857-20 |             |



Part Number - 370290

**Lockwasher**

▼ OEM Reference

HY 15918  
YT 03258600  
YT 3258600



Part Number - 370287

**Ball**

▼ OEM Reference

|           |              |
|-----------|--------------|
| HY 278374 | HY 2039858   |
| HY 379190 | YT 524141136 |



Part Number - 380700-027

**Ball 9/16 - Chrome Steel**

▼ OEM Reference

RA RA850-017



Part Number - 370311

**Seat Slide Kit**

▼ OEM Reference

HY 1467513  
HY 1470161  
HY 1563209  
HY 1584636  
HY 1584637  
YT 580013409  
YT 580014471  
YT 580049885  
YT 580057264  
YT 580057265



Part Number - 370320

**Shoe, Skid**

▼ OEM Reference

|               |               |
|---------------|---------------|
| AC 313494-000 | PM 313494-000 |
| BT 313494-000 | RA 313494-000 |
| KO 313494-000 |               |



Part Number - 370330

**Prop Button w/Switch-C**

▼ OEM Reference

|              |              |              |
|--------------|--------------|--------------|
| HY 800130355 | YT 524148522 | YT 582003465 |
|--------------|--------------|--------------|



Part Number - 370544

**Spacer**

▼ OEM Reference

|                |                |                   |
|----------------|----------------|-------------------|
| BT 623-003-120 | MB 1063126     | TY 00590-48484-71 |
| CL 7002134     | PM 623-003-120 | TY 00591-37571-81 |
| CT 1063126     | RA 623-003-120 | TY 00591-74106-81 |
| HY 3016084     | RA DS232309    | YT 220002075      |



Part Number - 370561

**Shim**

▼ OEM Reference

|            |                |                   |
|------------|----------------|-------------------|
| CL 7003231 | MB 1036847     | TY 00591-39911-81 |
| CT 1036847 | RA 623-019-000 | YT 220002691      |
| HY 3007210 | RA DS232716    |                   |



Part Number - 370513

**Screw**

▼ OEM Reference

|                |
|----------------|
| RA 715-037     |
| RA 715-037-100 |



Part Number - 370545

**Shim**

▼ OEM Reference

|            |                |                   |
|------------|----------------|-------------------|
| CL 7003230 | MB 1036848     | TY 00591-39910-81 |
| CT 1036848 | RA 623-020-000 | YT 220002693      |
| HY 3007214 | RA DS232717    |                   |



Part Number - 370516

**Spacer**

▼ OEM Reference

|            |                |                   |
|------------|----------------|-------------------|
| CL 7002211 | MB 1051247     | TY 00591-37670-81 |
| CT 1051247 | MB 217869      | YT 220027925      |
| CT 217869  | RA 820-001-542 | YT 220034052      |
| HY 3015111 | RA 824-000-390 |                   |



Part Number - 370546

**Bolt**

▼ OEM Reference

|            |                   |              |
|------------|-------------------|--------------|
| CL 7002228 | MB 1051246        | TY 220002062 |
| CT 1051246 | RA 824-000-382    |              |
| HY 3015955 | TY 00591-37693-81 |              |



Part Number - 370528

**Ring**

▼ OEM Reference

|            |                   |              |
|------------|-------------------|--------------|
| CL 7002217 | MB 1055778        | YT 220021117 |
| CT 1055778 | RA 116-000-331    |              |
| HY 3125804 | TY 00591-37678-81 |              |



Part Number - 370547

**Lug Bolt EZ Reach**

Used on Hub 358005

▼ OEM Reference

|               |               |                |
|---------------|---------------|----------------|
| BT 312206-000 | MB 1051305    | RA 828-003-193 |
| CT 1051305    | PM 312206-000 | RA DS236735    |
| HY 3039669    | RA 312206-000 | YT 220017073   |



Part Number - 370569

**Screw**

▼ OEM Reference

|               |
|---------------|
| RA 301922-100 |
|---------------|



Part Number - 351096-308

**Pallet Clamp Release Cable**

▼ OEM Reference

|            |
|------------|
| RA 1085703 |
|------------|



Part Number - 370540

**Screw**

▼ OEM Reference

|             |              |             |
|-------------|--------------|-------------|
| CT NA013590 | MB NA013590  | RA DS226465 |
| HY 3126421  | RA 5-003-019 |             |



Part Number - 351096-264

**Cable Pallet Grab**

▼ OEM Reference

|            |                   |              |
|------------|-------------------|--------------|
| CT 1037081 | RA 114-008-507    | YT 220036691 |
| HY 3135828 | RA 114-009-664    |              |
| MB 1037081 | TY 00591-75898-81 |              |



Part Number - 370538

**Shim**

▼ OEM Reference

|            |                   |              |
|------------|-------------------|--------------|
| CT 219526  | RA 771-040        | YT 220008914 |
| HY 3014635 | RA 771-147        |              |
| MB 219526  | TY 00591-70381-81 |              |



Part Number - 351096-335

**Pulley**

▼ OEM Reference

|            |
|------------|
| RA 1197851 |
|------------|

## Miscellaneous



Part Number - 370465  
**Guard-String Cutter**

▼ OEM Reference  
 BR 40373-FS000  
 NI 40373-FS000



Part Number - 370725  
**Center Cylinder Pulley**

▼ OEM Reference  
 TY 68804-25160-71



Part Number - 370513  
**Screw**

▼ OEM Reference  
 RA 715-037  
 RA 715-037-100



Part Number - 370501-798  
**Speed Sensor**

▼ OEM Reference  
 HY 1541232  
 YT 580056272



Part Number - 370716  
**Hose Clamp**

▼ OEM Reference  
 CT A0000-30113  
 MB A0000-30113  
 TY 68651-23470-71



Part Number - 398000-059  
**Universal Decal Kit**

▼ OEM Reference  
 TY 00591-07802-81

## Casters



### Available in 4 sizes:

- Phenolic, High Capacity Wheels
- Swivel or Rigid Options
- Durable
- Provides Floor Protection

See the Wheels and Tires Section

## Crown Creeper Seat

Part Number 322306



### Seat Features:

- High density foam padded seat
- Integrated storage drawer
- 300 lb. weight limit
- 20" height
- 16 gauge 1" steel frame
- 2.5" polypropylene casters

See the Tools Section

# Battery Monitoring Identification Device

Ensures Optimum Charging to Protect Batteries

## The Battery Monitoring Identification Device (BMID) Features:

- Automatically configures to the correct charge curve to match the battery size
- Measures and records DC amps during charge and discharge cycles
- Battery temperature sensing throughout the charge cycle to monitor and adjust the charge profile as needed
- Electrolyte level monitoring will signal an alarm if the water level is low
- Midpoint voltage sensing option to initiate an auto equalization based on the condition of the battery voltage
- Bluetooth for wireless download of charge events



## With Access to Expanded Reporting Through the BMID, You Can View:

- Lifetime data of your batteries
- Charging history
- Alarm history
- Equalization cycles



**INTELLIGENT  
CONTROL**



**LONGER  
BATTERY LIFE**

## Section 5

# Internal Combustion (IC) Truck Components

## Contents

|  |      |
|--|------|
| Seats/Replacement Parts  | 5.02 |
| Seat Belts   | 5.08 |
| LPG Tanks  | 5.09 |
| Fuel/LPG   | 5.10 |
| Starters/Replacement Parts   | 5.14 |
| Pumps/Parts  | 5.17 |
| Alternators  | 5.19 |
| Radiators and Accessories  | 5.21 |
| Miscellaneous Brake Parts  | 5.25 |
| Cylinders/Parts  | 5.32 |
| Tune-Up Kits and<br>Planned Maintenance Kits   | 5.36 |
| Distributors/Caps, Rotors,<br>Spark Plug Wires   | 5.37 |
| Coils  | 5.41 |
| Spark Plugs  | 5.42 |
| Fan Blades   | 5.44 |
| Belts  | 5.45 |
| Seals  | 5.47 |
| Pipes  | 5.51 |
|  Transmission/Drive Train | 5.51 |
| Miscellaneous  | 5.52 |

### New Items:

Seats - p. 5.04 - 5.06  
 Seat Cushions - p. 5.06 - 5.07  
 Retractable Electric Seat Belts - Open - p. 5.08  
 Starter - p. 5.14  
 Water Pump - p. 5.17  
 Radiators - p. 5.22  
 Parking Brake Cable - p. 5.29  
 Cup Shoe Hold Down - p. 5.30  
 Parking Brake Pedal - p. 5.31  
 Spark Plug Tube - p. 5.41  
 Muffler - p. 5.51  
 Strainer & Cup - p. 5.51  
 Directional Switch - p. 5.61  
 Knuckle (RH) - p. 5.62  
 Post, Overhead Guards - p. 5.63

Note: "1910.178(q)(5) All parts of any such industrial truck requiring replacement shall be replaced only by parts equivalent as to safety with those used in the original design."

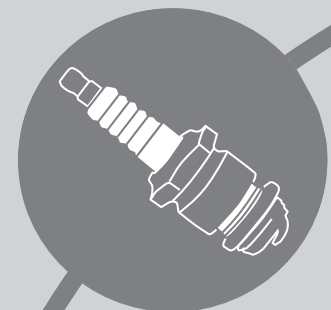



Part Number - 380070-001

**Lumbar Seat  
Forward Tilt & Fold Back**

Part Number - 380070-001-E  
**Seat with Electric Switch**

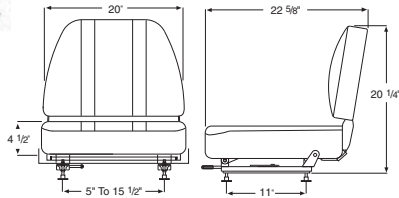

- Seat belt brackets
- Heavy duty 3/4" tubular frame with Flex-O-Lator & coil spring support
- 6" fore & aft adjusters
- 11" O/C front to rear mount
- 5" to 15 1/2" lateral adjustment
- 1.4 lb. density foam pack with 55 lb. compression foam cushion

▼ OEM Reference

|                 |                |                   |
|-----------------|----------------|-------------------|
| AF 00440        | IN STWM599     | TC 24846-80302    |
| CT 973522       | LP 753-7035    | TC 27416-80201    |
| ET 32002        | LP WM-599      | TC 27416-80202    |
| ET 32106        | NI 87000-60K05 | TY 00591-07835-81 |
| HM MODEL100     | NI 87000-L2000 | TY 00591-07876-81 |
| HM MODEL100-ELE | NI 87000-L2100 | TY 00591-30008-81 |
| HY 3022576      | NI FLPRSS000   | TY 00591-58448-81 |
| HY 3029291      | SY 800116885   | YT 150016902      |
| HY 3030127      | SY 1862        | YT 150016903      |
| HY 3031084      | TC 22196-82001 | YT 150039503      |
| IN 85-347       | TC 23656-80102 | YT 150039766      |
| IN ST973522     | TC 24846-80301 |                   |



Part Number - 380070-015

**Injection Molded Seat  
Straight Back**

Part Number - 380070-015-E  
**Seat with Electric Switch**

Switch P.N. 380030-182

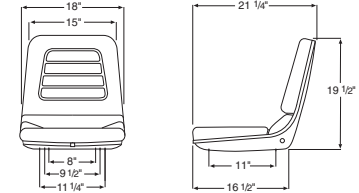

- Molded 1-PC seat assembly
- Heavy 14 gauge steel frame with black powder coat finish
- 6" fore & aft adjusters 11" O/C mounting
- 8"-9 1/2"-11 1/4"-18" lateral adjustment
- Hip restraints mounting
- Contoured molded foam for optimum body support
- 67 mil. heavy duty black molded cover

▼ OEM Reference

|                  |            |                   |
|------------------|------------|-------------------|
| AF 00439         | HY 138081  | IN STWM1183       |
| ET 32005         | HY 192268  | LP 753-7022       |
| ET 32005-WS      | HY 364911  | ST WM1183         |
| GM 0706-1943     | HY 377904  | SY 1732           |
| HM MODEL1500     | HY 377967  | SY 1769           |
| HM MODEL1500-ELE | HY 806441  | TY 00591-32859-81 |
| HY 127504        | HY 3032277 | TY 00591-58466-81 |
| HY 130798        | HY 3054800 | YT 220013187      |
| HY 130799        | HY 3058160 | YT 504232248      |
| HY 130800        | IN 85-137  | YT 504236274      |



Part Number - 380070-013

**Full Body Seat  
Forward Tilt and Fold Back**

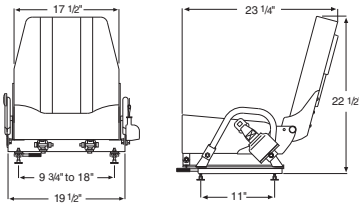

- With Retractable Seat Belt
- Heavy duty steel frame with black enamel finish
- 6" fore & aft adjusters
- 11" O/C front to rear mount
- 9 3/4" to 18" lateral adjustment
- Contoured back and seat cushions
- 32 oz. fire retardant vinyl
- Multi position folding back rest
- Hip restraints

▼ OEM Reference

|              |                   |           |
|--------------|-------------------|-----------|
| HM MODEL1300 | SY 1627           | WS WM1208 |
| SY 800048446 | TC WM1208         |           |
| SY 800116971 | TY 00591-21199-81 |           |



Part Number - 380070-022

**Bucket Seat  
Fold Back**

Part Number - 380070-022-E  
**Seat with Electric Switch**

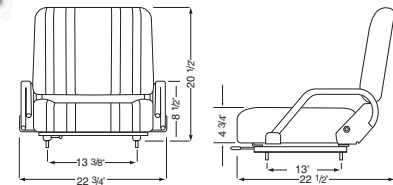

- Safety hip restraints
- Heavy steel frame with black powder coat finish
- 6" fore & aft adjusters 11" O/C mounting
- 11" & 13 3/8" lateral adjustment
- Contoured molded foam for optimum body support
- No-Sag spring construction
- 50 oz. heavy duty black vinyl

▼ OEM Reference

|                   |                 |                   |
|-------------------|-----------------|-------------------|
| AC 3EB-50-A5890   | KO 4901422      | NI 87000-43K20    |
| BK KM3EB-50-A5890 | KO 4949484      | NI 87000-60K01    |
| CT A000026796     | KO 4968103      | NI 87600-91H55    |
| ET 32107          | KO 4969403      | ST WM745          |
| HM MODEL2200      | KO 3306-6134E   | SY 1866           |
| HM MODEL2200-ELE  | KO 3BB-50-A3120 | SY 34430          |
| HY 3125880        | KO 3EB-50-A5860 | TY 00591-07878-81 |
| HY 3135726        | KO 3EB-50-A5890 | YT 150039574      |
| IN 85-349         | KO 3EB-50-A4910 | YT 220027604      |
| IN STWM-745       | LP 753-7041     |                   |
| KM 3EB-50-A5890   | MB A000026796   |                   |





Part Number - 380070-016

**Suspension Seat (Vinyl)  
Straight Back**

Cloth seat see P.N. 380070-030

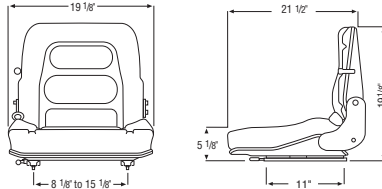

- Fore and aft adjustment 150mm in increments of 15mm
- Suspension stroke 40mm
- Weight adjustment 110-265 lbs. infinitely
- Angle adjustment of backrest infinitely 15°
- Specifically designed for a forklift which requires a low S.I.P.
- The fully integrated suspension within the backrest pan reduces harmful shocks for fatigue-free and safe operation
- The upholstery is of the vacuum formed and poured in-place type and can be easily exchanged for serviceability

▼ OEM Reference

|               |                |                   |
|---------------|----------------|-------------------|
| BK 3244331000 | JU 0760966     | SL 524145         |
| BK 3244331001 | JU 0762781     | ST 127266         |
| BK 3244331002 | JU 0763489     | ST ST116073       |
| BK 3244331005 | JU 0763590     | ST ST127266       |
| BK 3244331010 | JU 0763598     | ST STSGRS12B1     |
| BK 3244331011 | JU 2760966     | SY 800048466      |
| BK 3244331032 | JU 2763590     | SY 800048479      |
| BT 680396     | JU 6132896     | SY 800048480      |
| CL 1400305    | JU 14057390    | SY 800048486      |
| CL 2389314    | JU 14388510    | SY 800116985      |
| CL 2793120    | JU 27609660    | SY 800124739      |
| CL 3737932    | JU 27627810    | SY 1535           |
| CL 3772793    | JU 27632940    | SY 1660           |
| CL 3777118    | JU 27634890    | SY 1670           |
| CL 3796400    | JU 27635900    | SY 1675           |
| CL 3796460    | JU 27635980    | SY 1960           |
| CL 4308663    | JU 27636190    | SY 1990           |
| CL 4310868    | JU 27636200    | SY 35425          |
| CL 4358426    | JU 27637070    | TA 90-160-70      |
| CL 5456200    | JU 50010821    | TN 1056543        |
| CL 6632388    | JU 61260430    | TY 00591-02129-81 |
| ET 32001      | JU 61263920    | TY 00591-32845-81 |
| GG 1129306    | JU 61328960    | TY 00591-34208-81 |
| HM MODEL1600  | JU 70051620    | TY 00591-58460-81 |
| HY 116073     | LP 753-3003    | TY 00591-58462-81 |
| HY 226198     | LP 753-7003    | TY 53710-20720-71 |
| HY 309702     | MN 208521      | TY 53730-20720-71 |
| HY 322757     | MN 409115      | YT 150019501      |
| HY 326480     | MT 4207919651  | YT 220071655      |
| HY 335599     | MT 4209717924  | YT 220073083      |
| HY 374171     | NI 0255-49NNN  | YT 220079977      |
| HY 377906     | NI 87000-03K00 | YT 504226267      |
| HY 823886     | SL 300558      | YT 504235296      |
| HY 1345826    | SL 521452      | YT 505959514      |
| HY 3069750    | SL 522414      | YT 751647603      |



Part Number - 380070-030

**Suspension Seat (Cloth)  
Straight Back**

Vinyl seat see P.N. 380070-016

▼ OEM Reference

|               |               |                   |
|---------------|---------------|-------------------|
| BK 3244331015 | HY 3070641    | SY SY1995         |
| CL 1802151    | IN 85-125     | TN 34251          |
| CL 1802446    | LI 3244331015 | TN 53845          |
| CL 2775193    | LP 753-3004   | TY 00591-01114-81 |
| CL 3736995    | LP 753-7005   | TY 00591-32847-81 |
| CT A000028641 | MB A000028641 | TY 00591-34209-81 |
| ET 32068      | MH 3300489    | TY 00591-58461-81 |
| ET 32088      | MN 454238     | TY 00591-58463-81 |
| ET 32145      | SY SY1665     | YT 150019503      |
| HM MODEL3000  | SY SY1965     | YT 220072123      |



Part Number - 380070-023

**Contoured Pan Seat  
Fold Back**

Part Number - 380070-023-E  
**Seat with Electric Switch**

Switch P.N. 380030-182

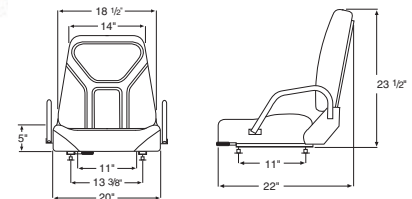

- Seat belt
- Adjustable back/hip restraint
- 6" fore & aft adjusters 11" O/C mounting
- 11" & 13 3/8" lateral mounting
- 14 gauge steel tubing
- 20" wide bottom seat cushion
- 18 1/2" tapered back cushion
- No-Sag spring construction
- 50 oz. heavy duty black vinyl
- Contoured molded foam for optimum body support
- Folding back rest with operator pouch

▼ OEM Reference

|                   |                  |                   |
|-------------------|------------------|-------------------|
| AC 8005-2116E     | KO 3EA-50-A1150  | KO H08005-2116    |
| AC HO8005-2116E   | KO 3EB-50-16110  | KO HO3110-19      |
| AF 00438          | KO 3EB-50-A5160A | KO HO8002-2113    |
| BK KMH08003-2113  | KO 3EB-50-A5180  | KO HO8003-2113    |
| BK KMH08005-2116E | KO 3EB-50-A5181  | KO HO8005-2116    |
| HM MODEL2300      | KO 3EB-50-A5181B | LI KM3EB-50-A5180 |
| HM MODEL2300-ELE  | KO 3EB-50-A5930  | LI KM3EB-50-A5930 |
| KO 3303-8116E     | KO H03110-17     | SY 1790           |
| KO 3EA-50-A1120   | KO H03110-19     | TC WM1077         |



Part Number - 380070-026

**Contoured Back Seat  
Fold Back**

Part Number - 380070-026-E

**Seat with Electric Switch**

- Seat belt
- 14 gauge stamped steel
- 2 piece molded cushion
- 67 mil. heavy duty vinyl
- Multi adjustment 11", 13" & 13½"

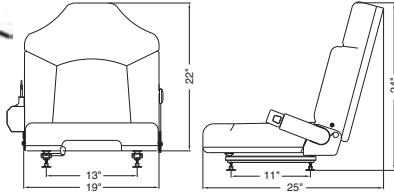

▼ OEM Reference

|              |              |                  |
|--------------|--------------|------------------|
| BK 147394    | CL 926069    | HM MODEL2600-ELE |
| BR 908830    | CL 926072    | LI 147394        |
| BR 926069    | CL 1636257   | NI CK908830      |
| BR CK2813105 | CL 2389326   | NI CK926069      |
| CK 908830    | CL 2389703   | SY 800048420     |
| CK 926069    | CL 2795958   | SY 1584          |
| CL 908830    | CL 2803280   | YT 220170056     |
| CL 908831    | CL 2817183   |                  |
| CL 915588    | HM MODEL2600 |                  |



Part Number - 380070-032

**Molded Seat  
Fold Back**

Part Number - 380070-032-E

**Seat with Electric Switch**

Switch P.N. 380030-182

- Retractable seat belt
- 14 gauge steel pan
- 2 piece molded cushion
- 67 mil. heavy duty vinyl
- Shoulder restraint
- Multi adjustment 11" & 13"

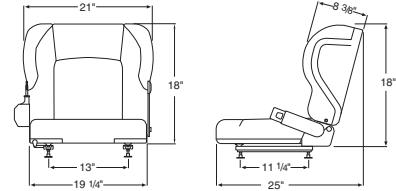

▼ OEM Reference

|                   |                   |                   |
|-------------------|-------------------|-------------------|
| CL 448492         | TY 53706-U2001-71 | TY 53760-23000-71 |
| CL 448494         | TY 53706-U2100-71 | TY 53760-23001-71 |
| HM MODEL3200      | TY 53730-U2100-71 | TY 53760-23610-71 |
| SY 1698           | TY 53740-22750-71 | TY 53760-U2100-71 |
| TY 53706-U2000-71 | TY 53740-23000-71 |                   |

▼ OEM Reference for Seat with Electric Switch Part No. 380070-032-E

|                   |                   |                   |
|-------------------|-------------------|-------------------|
| HM MODEL3200-ELE  | TY 53710-U1160-71 | TY 53740-13300-71 |
| SY 1695           | TY 53720-U1090-71 |                   |
| TY 53710-U1090-71 | TY 53740-11590-71 |                   |



Part Number - 380070-029

**Contoured Seat  
No Tilt or Fold Back**

- 67 mil. heavy duty vinyl
- Self-draining seat
- Seat belt mounting
- Contemporary styling
- Contoured for operator comfort
- 14 gauge stamped steel shell with black powder coat finish

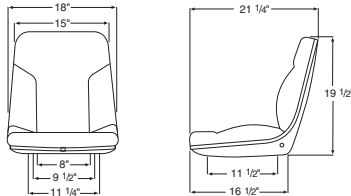

▼ OEM Reference

|               |              |              |
|---------------|--------------|--------------|
| CT A000028830 | SY 800048444 | TC WM1268-1  |
| HM MODEL2900  | SY 1625      | YT 504268740 |



Part Number - 380070-036-E

**Suspension Molded Seat with  
Electric Switch**



- Adjustable backrest fore & aft ± 45 degrees
- Fore and aft slide-rail with adjustment of 150mm
- Retractable seat belt
- Mechanical suspension integrated in cushion
- Popular mounting size: side to side x front to back (228-230mm) x (280-290mm) or (328-330mm) x (280-290mm)

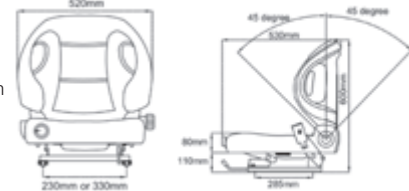

▼ OEM Reference

|                   |                   |                   |
|-------------------|-------------------|-------------------|
| HM MODEL3600      | TY 53710-88300-71 | TY 53720-U2230-71 |
| TY 53710-13131-71 | TY 53710-88301-71 | TY 53730-26701-71 |
| TY 53710-23320-71 | TY 53710-88302-71 | TY 53780-U2101-71 |
| TY 53710-23421-71 | TY 53710-F2131-71 | TY 53830-98333-71 |
| TY 53710-23620-71 | TY 53710-F2132-71 | TY 53850-98334-71 |
| TY 53710-26601-71 | TY 53710-U2230-71 | TY 53960-88300-71 |
| TY 53710-26701-71 | TY 53710-U2231-71 |                   |



Part Number - 380070-035

**Molded Seat  
Fold Back**

Part Number - 380070-035-E

**Seat with Electric Switch**

Switch P.N. 380030-182

- Adjustable back angle 90° - 120°
- Adjustable lumbar with hip restraint
- 14¼" x 11" adjuster spacing
- Metal pan seat and back
- Vinyl pouch on back

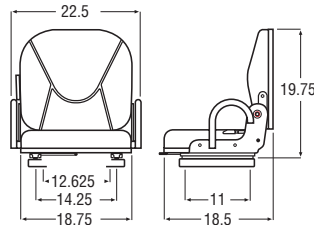

▼ OEM Reference

|                |                  |         |
|----------------|------------------|---------|
| CT 93014-00010 | HM MODEL3500-ELE | SY 1424 |
| HM MODEL3500   | MB 93014-00010   |         |



Part Number - 380070-012

**Pan Seat  
Straight Back**

Part Number - 380070-012-E

**Seat with Electric Switch**

Switch P.N. 380030-182

- Swing up molded armrest
- 14 gauge steel black powder coat finish pan frame
- 6" fore & aft adjusters 11" O/C 4 ¼" front to rear mount
- 4" to 11¼" lateral adjustment
- 1.4 lb density foam pack with 55 lb. compression foam cushion
- 50 oz. fire retardant black madrid expanded vinyl

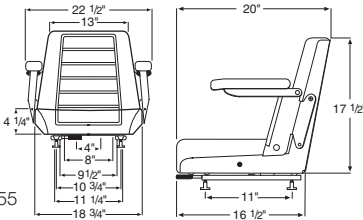

▼ OEM Reference

|                  |          |                   |
|------------------|----------|-------------------|
| HM MODEL1200     | SY 1848  | TY 00591-07862-81 |
| HM MODEL1200-ELE | TC WM684 | WS WM684          |
| SY 800116870     |          |                   |



Part Number - 380070-037-E

**Molded Seat with Electric  
Switch**

Part Number - 380030-133

**Adjuster Knob (Front)**

OEM P.N. 380070-037-EO



- Retractable safety belt
- Fore and aft slide rail with adjustment of 150mm
- Document bag
- Electric switch
- Universal mounting pan covering:
  - Toyota: 330 x 285mm
  - TCM: 230 x 285mm
  - Mitsubishi: 320x275mm
  - Komatsu: 340 x 255mm
  - Nissan: 280 x 280mm

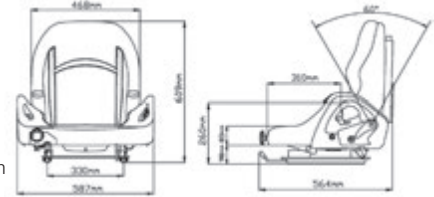

▼ OEM Reference

|                |                |                |
|----------------|----------------|----------------|
| CT 91A14-01030 | HM MODEL3700   | NI 87000-FW50B |
| CT 91A14-11010 | LP 753-2049    | NI 87000-FW60A |
| CT 91A14-21010 | NI 87000-6G210 | YT 800037371   |
| CT 91A14-21030 | NI 87000-6G400 |                |



Part Number - 380070-009

**Pan Seat  
Straight Back**

Part Number - 380070-009-E

**Seat with Electric Switch**

Switch P.N. 380030-182

- 16 gauge steel black powder coat finish pan frame
- 6" fore & aft adjusters 11" O/C front to rear mount
- 4" to 11½" lateral adjustment
- 1.4 lb density foam pack with 55 lb. compression foam cushion
- 40 oz. fire retardant black madrid expanded vinyl

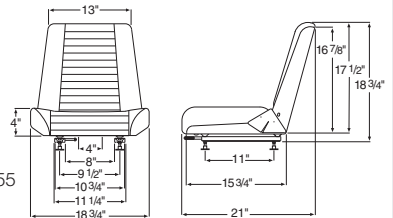

▼ OEM Reference

|                 |                   |                   |
|-----------------|-------------------|-------------------|
| AF 00459        | LP 753-3001       | TY 00591-07880-81 |
| BK 104056       | LP WM127          | TY 00591-30004-81 |
| BR 87000-UMP00  | MB ST973139       | TY 00591-32844-81 |
| CT 0973139      | ME S4304-79-11    | TY 00591-34205-81 |
| HM MODEL900     | ME S4304-79-2     | TY 00591-58444-81 |
| HM MODEL900-ELE | ME S4304-79-9     | YT 150016901      |
| HY 109983       | NI 87000-UMP00    | YT 150039250      |
| HY 3021855      | NI FLPRTPSP0006   | YT 150039755      |
| HY 3026746      | NP 8231310        | YT 514092400      |
| HY 3031979      | NP BK8231310      | YT 518324400      |
| HY 109983A      | TC WM-127         | YT 519678401      |
| HY 112155A      | TC WM682          |                   |
| LI 104056       | TY 00591-07818-81 |                   |
| LP 753-2003     | TY 00591-07859-81 |                   |

**Seats**



Part Number - 380070-020

**Pan Seat With Tracks  
Straight Back**

Part Number - 380070-020-E  
**Seat with Electric Switch**

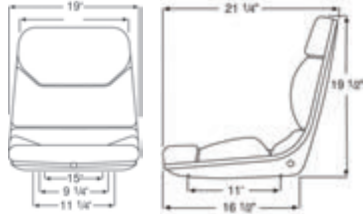

- 14 ga. steel tube frame with black powder-coat finish
- Heavy-duty vinyl
- Self-draining seat
- Seat belt mounting

▼ OEM Reference

|                |                  |                   |
|----------------|------------------|-------------------|
| CL 448114      | HY 1603739       | MB 91214-25400    |
| CL 1802035     | HY 1645425       | MB 91314-08500    |
| CT 1075199     | HY 2087813       | MB 91314-18400    |
| CT 1097337     | HY 275674        | ST SA8604         |
| CT 1129505     | HY 377901        | ST STV830         |
| CT 1129507     | HY 388515        | ST STWM917A       |
| CT 1223226     | HM MODEL2000     | SY 1867           |
| CT 91214-09400 | HM MODEL2000-ELE | TY 00591-07879-81 |
| CT 91214-13400 | IN SA8604        | TY 00591-32834-81 |
| CT 91214-15400 | IN STV830        | YT 150016910      |
| CT 91214-19400 | IN STWM917A      | YT 220024381      |
| CT 91214-25400 | LP 753-3009      | YT 220035307      |
| CT 91314-18400 | LP 753-7052      | YT 504232239      |
| CT 91314-08500 | MB 1075199       | YT 504285754      |
| CT 971724      | MB 1129505       | YT 504305738      |
| ET 32041       | MB 1223226       | YT 520042839      |
| HY 0275674     | MB 91214-09400   | YT 524279699      |
| HY 0377901     | MB 91214-13400   | YT 580057480      |
| HY 1351431     | MB 91214-15400   | YT 580071141      |
| HY 1525925     | MB 91214-19400   | YT 580071298      |



Part Number - 380070-027

**Molded Seat  
Straight Back**

Part Number - 380070-027-E  
**Seat with Electric Switch**

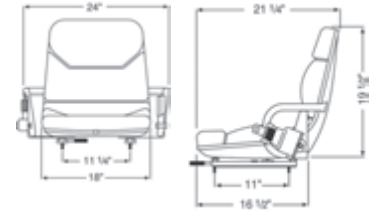

- One-piece drawn 14 ga. pan with black powder-coat finish
- Retractable seat belt and hip restraints
- Heavy-duty vinyl
- Self-draining seat
- Seat belt mounting

▼ OEM Reference

|            |                |                  |
|------------|----------------|------------------|
| CL 448324  | CT 6R7182      | CT 91214-53900   |
| CT 1029645 | CT 91214-11300 | HM MODEL2700     |
| CT 1033164 | CT 91214-21100 | HM MODEL2700-ELE |
| CT 1037451 | CT 91214-31100 | MB 1029645       |
| CT 1038589 | CT 91214-31300 | SY 800048442     |
| CT 1049976 | CT 91214-36300 | SY SY1623        |
| CT 1058285 | CT 91214-41100 | SY SY1771        |
| CT 1097358 | CT 91214-41300 |                  |
| CT 6R7181  | CT 91214-43900 |                  |



Part Number - 380070-100-E

**Molded Seat Fold Back  
with Electric Switch**

▼ OEM Reference

|                      |
|----------------------|
| HM 53720-U223171-OEM |
| TY 53720-U2231-71    |



**Seat Replacement Parts**

Continued ▶



Part Number - 380071-000

**Seat Cushion - Bottom Vinyl**

▼ OEM Reference  
NI 87311-FB400



Part Number - 380070-038

**Seat Cushion - Bottom Vinyl**

▼ OEM Reference  
BR 87320-FW80B  
NI 87320-FW80B

## Seat Replacement Parts



Part Number - 380030-332  
**Seat Cushion - Bottom Vinyl**

▼ OEM Reference  
CT W505010682  
CL 7005732  
HY 1563207  
MB W505010682  
YT 580049883



Part Number - 380073  
**Seat Cushion - Bottom Vinyl**

▼ OEM Reference  
HY 1703902



Part Number - 370777  
**Seat Cushion - Bottom Cloth**

▼ OEM Reference  
YT 580095472



Part Number - 380030-182  
**Seat Switch**

For use with Crown seats:  
380070-009-E 380070-023-E  
380070-012-E 380070-032-E  
380070-015-E 380070-035-E

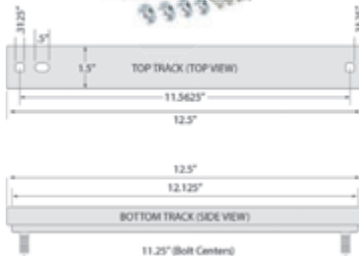

Part Number - 380030-265  
**Seat Tracks**

▼ OEM Reference  
HM WM-637-28  
TC FA4846-82121  
TC FC-WM637-28  
TC 53723-U1090-71  
TC 53724-U1090-71  
TC 53735-U2100-71  
TC 53736-U2100-71

For use with Toyota 6 Series



Part Number - 380030-321  
**Seat Switch - w/Harness, Non-Suspension**

▼ OEM Reference  
CT A0000-15661 HY 1367135 TY 00591-41919-81  
CL 7004181 HY 3057555 TY 00591-57479-81  
HY 1354140 MB A0000-15661 YT 518793606

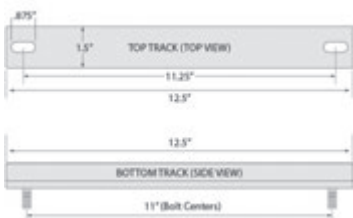

Part Number - 380030-264  
**Seat Tracks**

▼ OEM Reference  
HM WM-1250



Part Number - 380030-334  
**Seat Switch Operator Presence**

▼ OEM Reference  
HY 1563208  
YT 580049884

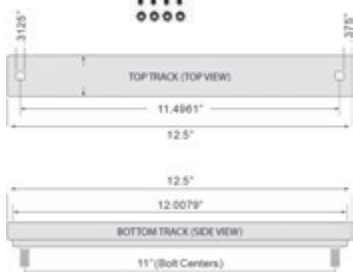

Part Number - 370311  
**Seat Slide Kit**

▼ OEM Reference  
HY 1467513  
HY 1470161  
HY 1563209  
HY 1584636  
HY 1584637  
YT 580013409  
YT 580014471  
YT 580049885  
YT 580057264  
YT 580057265



Part Number - 380030-133  
**Adjuster Knob**

▼ OEM Reference  
HM KNOB-173  
For use with  
Crown 380070-037-E seat

## Seat Belts

### Lap Belts

| Part Number | Description |
|-------------|-------------|
| 380080-048  | 48" Black   |
| 380080-060  | 60" Black   |
| 380080-072  | 72" Orange  |
| 380080-074  | 74" Black   |
| 380080-110  | 110" Black  |



380080-048

380080-060, 380080-074,  
380080-110

380080-072

### Retractable Seat Belts

| Part Number  | Description |
|--------------|-------------|
| 380081-060   | 60" Black   |
| 380081-060-O | 60" Orange  |
| 380081-072   | 72" Black   |



380081-060, 380081-072



380081-060-O

### Retractable Electric Seat Belts - Open

| Part Number   | Description |
|---------------|-------------|
| 370692        | 60" Orange  |
| 380082-060-E  | 60" Black   |
| 380082-060-OE | 60" Orange  |
| 380082-072-E  | 72" Black   |



370692



380082-060-E



380082-060-OE



380082-072-E

### Retractable Electric Seat Belts - Closed

| Part Number   | Description |
|---------------|-------------|
| 380084-060-OE | 60" Orange  |
| 380084-060-E  | 60" Black   |
| 380087        | 57" Black   |



380084-060-OE



380084-060-E



380087

### Retractable Anti-Cinch Seat Belts

| Part Number  | Description |
|--------------|-------------|
| 380083-060   | 60" Black   |
| 380083-060-O | 60" Orange  |



380083-060



380083-060-O

### Retractable Anti-Cinch Electric Seat Belts

| Part Number     | Description             |
|-----------------|-------------------------|
| 380085-060-E    | Open 60" Black          |
| 380082-060-E-NI | Open 60" Black - Nissan |
| 380085-060-OE   | Open 60" Orange         |
| 380086-060-E    | Closed 60" Black        |



380085-060-E



380086-060-E

#### Notes:

Seat belts meet requirements of SAE J386 and FMVSS 302.

An open circuit, when wired, does not require the latch (male side) be inserted into the buckle in order to start the forklift. If wired to a buzzer or to an alarm, they will sound until the latch (male side) is inserted into the buckle or if wired to a dash lamp, the lamp will stay illuminated until the latch (male side) is inserted into the buckle. A closed circuit, when wired, requires that the latch (male side) be inserted into the buckle to complete the circuit in order to be able to start the forklift.

## LPG Tanks



### Steel Tanks

| Part Number | Description         | Water Capacity lb/kg | Propane Capacity gal/liter | Length/Height in/mm | Diameter in/mm | Tare Weight lb/kg |
|-------------|---------------------|----------------------|----------------------------|---------------------|----------------|-------------------|
| 340012-005  | 20 lb. Steel Tank   | 47.6 / 21.6          | 4.6 / 17.4                 | 19 / 483            | 12.2 / 310     | 27 / 12.2         |
| 340012-008  | 33.5 lb. Steel Tank | 80 / 36.3            | 7.7 / 29.1                 | 27.3 / 692          | 12.2 / 310     | 36 / 16.3         |
| 340012-010  | 43.5 lb. Steel Tank | 104 / 47.2           | 9.9 / 37.5                 | 33.3 / 845          | 12.2 / 310     | 44 / 20.0         |

**Features:** Quick coupler installed. Permanently positioned relief valve with clear path to the outside of the cylinder. For vertical or horizontal mounting applications. Footring designed to withstand high impact. Stackable. Made in the USA. Cylinder conforms with strict compliance to DOT specification 4BA240 and Transport Canada specification 4BAM16.



### Aluminum Tanks

| Part Number | Description            | Water Capacity lb/kg | Propane Capacity gal/liter | Length/Height in/mm | Diameter in/mm | Tare Weight lb/kg |
|-------------|------------------------|----------------------|----------------------------|---------------------|----------------|-------------------|
| 340013-005  | 20 lb. Aluminum Tank   | 47.6 / 21.6          | 4.6 / 17                   | 20.4 / 518          | 12.3 / 312     | 17 / 7.7          |
| 340013-008  | 33.5 lb. Aluminum Tank | 80 / 36.3            | 7.4 / 28                   | 28.3 / 717.6        | 12.3 / 312     | 24 / 10.9         |
| 340013-010  | 43.5 lb. Aluminum Tank | 104 / 47.2           | 9.9 / 37.5                 | 33.9 / 862.1        | 12.3 / 312     | 25 / 11.3         |

**Features:** Quick coupler installed. Permanently positioned relief valve with clear path to the outside of the cylinder. For vertical or horizontal mounting applications. Footring designed to withstand high impact. Stackable. Aluminum cylinders are vacuum purged. Cylinders are shot blasted, resulting in a textured finish. Made in the USA. Cylinder conforms with strict compliance to DOT specification 4E240 and Transport Canada specification 4EM16.

### Tank Replacement Parts

| Part Number | Description   |
|-------------|---|
| 340065-001  | Sight Gauge with Dial Chamber   |
| 340065-002  | Dial Chamber for 340065-001   |
| 340065-004  | Service Valve (turns gas off to truck), 3/8" NPT, yellow cap included |
| 340065-005  | Fill Valve, 3/4" NPT X ACME   |



### Quick Change Propane Valve

Part Number - 340409

Fits on any forklift and steel propane tank. Offers quick and easy installation.



Part Number - 380001-011-02

### O-Ring Outer Flat 7141M3

▼ OEM Reference

|             |                   |                   |
|-------------|-------------------|-------------------|
| AG 7141M3   | PG 7141M3         | TY 00591-31740-81 |
| IN LPG-1066 | RE 7141M-3R       | TY 00591-51127-81 |
| IN LPG-1073 | TY 00591-31734-81 | YT 064926500      |



Part Number - 137811

### Clamp Toggle LP Tank

▼ OEM Reference  
KO TB260



Part Number - 136232

### Strap - LP Tank

12.16" diameter  
2" width



Part Number - 064423

### Connector LPG Female (OEM part)

▼ OEM Reference

|                |                  |                   |
|----------------|------------------|-------------------|
| KO 7141-F      | HM 7141F         | PG REGO7141F      |
| AC 4738548     | HY 0097999       | RE 7141F          |
| BK 101411      | HY 97999         | TY 00591-07632-81 |
| BK 9Y11863     | JL 2180387       | TY 00591-11157-81 |
| CL 655335      | KO 7141F         | TY 00591-31692-81 |
| CL 715976      | LP 225-6267      | TY 00591-51083-81 |
| CL 866176      | MB 1015874       | TY 23560-U2100-71 |
| CL 926119      | MB 93165-03600   | TY 23560-U2101-71 |
| CT 0045019     | MB 93165-03800   | WM 35A9482        |
| CT 1015874     | MB LM40AQ5019    | WM 35P519         |
| CT 45019       | MB LM40AQ5019    | YT 054966300      |
| CT 9316503600  | MB MDI700050     | YT 136350102      |
| CT 93165-03800 | MB MIC0053011    | YT 220014644      |
| CT LM40AQ5019  | MR E7141F        | YT 220050482      |
| CT MIC-0053011 | NI 78001-7141F   | YT 251102100      |
| DW 045019      | NI NF93165-03600 | YT 505966505      |
| DW D700178     | PG 7141F         | YT 912514300      |
| GA 557-04      | PG C-971-3       |                   |



Part Number - 380001-010-01

### Connector LPG Male (OEM part)

▼ OEM Reference

|               |                |                   |
|---------------|----------------|-------------------|
| KO 7141M      | CT 9316503500  | PG C-971-4        |
| AC 4737405    | CT MIC0053089  | PG REGO7141M      |
| BK 9Y11864    | GA 557-03      | RE 7141M          |
| CL 6016-10470 | HY 0124010     | TC 7141M          |
| CL 715977     | HY 3051152     | TY 00591-07633-81 |
| CL 926118     | MB 9136103501  | TY 00591-31696-81 |
| CT 0049099    | MB 9136113500  | TY 00591-51085-81 |
| CT 1085332    | MB 9300201300  | WM 35A9481        |
| CT 1085392    | MB 9316503500  | WM 35P517         |
| CT 49099      | MB MIC0053089  | YT 054966400      |
| CT 9136103500 | NI 78001-7141M | YT 136350101      |
| CT 9136103501 | NI 7B001-7141N | YT 220050483      |
| CT 9136113500 | NI CK715977    | YT 520035885      |
| CT 9300201300 | PG 7141M       |                   |
| CT 9316503500 |                |                   |



Part Number - 380001-001-01  
**Lockoff VFF-30-2-IMP (OEM part)**  
 Replacement part:  
 Repair Kit - P.N. 380001-004-01

▼ OEM Reference

|                |                  |                   |
|----------------|------------------|-------------------|
| AC 4870598     | HY 258321        | TC 53320-50401    |
| AC 74870598    | HY 287647        | TY 00591-08206-81 |
| AC 8641341     | HY 3052453       | TY 00591-31700-81 |
| BK 105627      | IMP VFF30-2      | TY 00591-44714-81 |
| CL 3675433     | KO 34B-04-46310  | TY 00591-51137-81 |
| CL 6015-10340  | MB 7N314         | TY 23640-U2000-71 |
| CL 923048      | MB 91865-03100   | YT 505966558      |
| CT 7N314       | MB C0053321      | YT 904990600      |
| CT 91865-03100 | ME CH170269-001  |                   |
| CT 9326500070  | NI 16245-VFF30   |                   |
| HY 0258321     | NI 16400-90H71   |                   |
| HY 0287647     | NI NF91865-13100 |                   |



Part Number - 380001-002-01  
**Converter JB-2 (OEM part)**  
 Replacement part:

▼ OEM Reference

|            |          |               |
|------------|----------|---------------|
| CL 932437  | IMP JB   | KO JB         |
| CL 2360140 | IMP JB-2 | YT 5170798-00 |



Part Number - 380001-018-01  
**Converter, GFI (OEM part)**

▼ OEM Reference  
 HY 2056762  
 HY 4602051  
 YT 582001994



Part Number - 380001-003-01  
**Converter Cobra (OEM part)**  
 Replacement part:  
 Repair Kit - P.N. 380001-006-01

▼ OEM Reference

|                |                |                   |
|----------------|----------------|-------------------|
| AC 74830760    | CT 93465-10010 | IMP 1085401       |
| AC 74884393    | DOS A218012    | IMP 1085402       |
| CL 923049      | DW A218012     | IMP COBRA         |
| CL 932435      | HY 1458025     | NI 6016-10330     |
| CT 91465-0020  | HY 2023640     | TC 53320-50501    |
| CT 93165-03100 | HY 2026468     | TY 23530-22800-71 |
| CT 93165-23100 | HY 195193      | YT 505959551      |
| CT 93165-13100 | HY 196193      | YT 520002399      |
| CT 93265-10060 | HY 213549      | YT 520037830      |
| CT 93265-10080 | HY 3004951     | YT 580002388      |
| CT 93265-20800 | HY 3052059     | YT 580002399      |
| CT 93265-30800 | IMP 1040397    |                   |



Part Number - 380001-007-01  
**Repair Kit CA100/CA125 (OEM part)**

▼ OEM Reference

|                |                   |                   |
|----------------|-------------------|-------------------|
| AC 4906962     | JU 141150106      | TY 00591-05456-81 |
| BK 3155729000  | JU 14348300       | TY 00591-14729-81 |
| CL 448383      | JU 14348310       | TY 00591-31729-81 |
| CL 998838      | JU 14348320       | TY 00591-31741-81 |
| CT 91865-06400 | LI 9810306        | TY 00591-51156-81 |
| DW 7W5191      | LI D3155729000    | YT 220079907      |
| DW D700725     | MB 7W5191         | YT 505963504      |
| HY 204782      | MB A0000-00355    | YT 505963589      |
| HY 1358246     | MB LM4AHN9223     | YT 516987805      |
| HY 1358247     | NI CK998838       | YT 520045894      |
| HY 3052003     | PG AV1-14-1       | YT 900971806      |
| HY 3069660     | PG AV1-14-4       | YT 900971809      |
| IMP AV1-14-4   | PG N00-7426A      | YT 900971837      |
| JU 14115000    | TC 52050-59871    | YT 902249814      |
| JU 14115010    | TC DET000997      |                   |
|                | TY 00591-04117-81 |                   |



Part Number - 380001-004-01  
**Repair Kit VFF30-2 (380001-001-01) (OEM part)**

▼ OEM Reference  
 KO RK-VFF30-2

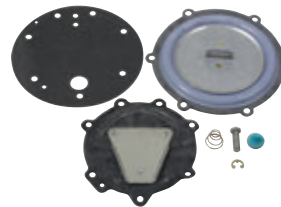

Part Number - 380001-006-01  
**Repair Kit Cobra (380001-003-01) (OEM part)**

▼ OEM Reference

|                |                  |                   |
|----------------|------------------|-------------------|
| CL 920165      | HY 2026467       | TY 00591-14608-81 |
| CL 923292      | HY 2026721       | TY 00591-14711-81 |
| CL 932698      | IMP RK-COBRA     | YT 518807650      |
| CT 93165-13110 | IMP RK-K         | YT 580007732      |
| DW A213955     | IMP RK-K-2       | YT 902057822      |
| HY 1375031     | IMP N00-6314A    | YT 902057825      |
| HY 1459717     | JU 14518910      | YT 902057827      |
| HY 2023646     | MB 93165-13110   | YT 924088300      |
| HY 2023647     | NI NF93165-13110 |                   |



Part Number - 380001-005-01  
**Repair Kit JB2 (380001-002-01) (OEM part)**

▼ OEM Reference

|                 |                   |                   |
|-----------------|-------------------|-------------------|
| BK 1055931      | MB MIC-0053100I   | TY 00591-64562-81 |
| HY 30049581     | MB MIC-0053110I   | TY 04255-U201171  |
| IMP RKJ         | MB MDI-700210I    | YT 517080800I     |
| MB 93165-03110I | TY 00591-14708-81 | YT 900969823I     |
| MB MDI-700210I  | TY 00591-44723-81 |                   |





Part Number - 380001-040-01

**Repair Kit (IMPCO)**

▼ OEM Reference  
IMP RK-EPR-3-IMP



Part Number - 380001-008-01

**Regulator LPG (OEM part)**

- 30N10 Tag #
- UL-LP, UL-LPS, UL-G/LP, LPG UK

▼ OEM Reference  
TY 23530-U1100-71  
TY 23530-U1101-71  
TY 23530-U1102-71  
TY 23530-U1103-71  
TY 23530-U1104-71



Part Number - 380001-017

**Regulator (Aisan)**

- 30M40 Tag #

▼ OEM Reference  
TY 23510-U2230-71



Part Number - 380001-019

**Regulator (Aisan)**

- 30M60 Tag #

▼ OEM Reference  
TY 23540-U2230-71  
TY 23560-U2230-71



Part Number - 380001-020

**Regulator (Aisan)**

- 30M50 Tag #

▼ OEM Reference  
TY 23550-U2230-71  
TY 23570-U2230-71



Part Number - 380001-028-02

**Regulator (Aisan)**

- 30S50 Tag #

▼ OEM Reference  
TY 23530-U2201-71



Part Number - 380001-021

**Regulator (Aisan)**

- 30P30 Tag #

▼ OEM Reference  
HY 1594144  
YT 5800604-05  
YT 580060405



Part Number - 380001-042-02

**Regulator**

- N-2007

▼ OEM Reference  
CL 5233-1018  
DW A403937

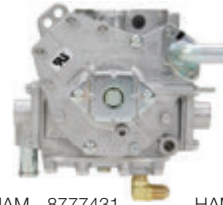

Part Number - 380001-013-01

**Vaporizer  
K21-K25 (OEM part)**

Repair Kit - P.N. 380030-069

▼ OEM Reference  
HAM 8777431      HAM 16310-GS40A      NI 16310-GS40A  
HAM 8779362      HAM 16310-GU20A      NI 16310-GU20A

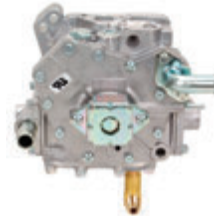

Part Number - 380001-012-01

**Vaporizer  
K21-K25 (OEM part)**

Repair Kit - P.N. 380030-069

▼ OEM Reference  
KO 16310-FT860



Part Number -  
380001-015-01

**Vaporizer  
Nikki (OEM part)**

Repair Kit - P.N. 380030-069

▼ OEM Reference  
AC AC8772296      NI 16310-GS00A      NI 16310-GY36B  
CT 91A65-01601      NI 16310-GS00C      NI 16310-GZ560  
CT 91A65-21600      NI 16310-GY361      TC 547C0-52001



Part Number - 380001-023

**Vaporizer  
Nikki (OEM part)**

▼ OEM Reference  
NI 16310-GS40B  
NI 16310-GS40C



Part Number - 380030-319

**Body - Throttle 4Y**

▼ OEM Reference  
 TY 22030-78640-71  
 TY 22030-UB010-71



Part Number - 380030-060

**Diaphragm Kit (Nikki)**

▼ OEM Reference  
 CT 91H20-14470  
 KO 17960-VR500  
 NI 17960-VR500



Part Number - 380030-069

**Repair Kit  
 K21-K25 (OEM part)**

For 380001-012-01, 380001-013-01  
 & 380001-015-01 vaporizers

▼ OEM Reference

CT 90425-08490    KO 16328-GY010    NI 16328-GY010  
 CT 91965-07500    NI 16328-GS00A



Part Number - 380030-111

**Diaphragm Kit (Nikki)**

▼ OEM Reference  
 CT 91H20-04380  
 HM 17053-FU460  
 KO 17053-FU460  
 NI 17053-FU460



Part Number - 380001-016

**Repair Kit**

For 380001-012-01, 380001-013-01  
 & 380001-015-01 vaporizers

▼ OEM Reference  
 NI 16310-RPKIT



Part Number - 380001-027

**Plate - Input**

▼ OEM Reference  
 KO 30B-13-11120



Part Number - 380001-041-01

**Secondary Diaphragm**

▼ OEM Reference  
 IMP RK-EPR-5-IMP



Part Number - 380001-024

**Filter**

▼ OEM Reference  
 HY 2070100    YT 580051579  
 HY 800138303    YT 580090374



Part Number - 380030-132

**Diaphragm Kit**

▼ OEM Reference  
 TY 04221-U2010-71



Part Number - 380030-188

**Injector**

▼ OEM Reference  
 HY 1620009  
 YT 524248301



Part Number - 380101-477

**Diaphragm Kit (Aisan)**

▼ OEM Reference

|                |                   |                   |
|----------------|-------------------|-------------------|
| CL 448689      | HY 1479531        | TY 04221-U1102-71 |
| CL 7005029     | TY 04221-20400-71 | TY 04221-U1103-71 |
| CT A0000-14995 | TY 04221-20401-71 | TY 04221-U1104-71 |
| CT A0000-16040 | TY 04221-U1100-71 | YT 580017217      |
| CT A0000-18901 | TY 04221-U1101-71 |                   |



Part Number - 380030-272

**Injector**

▼ OEM Reference  
 TY 23260-76001-71



Part Number - 380030-073

**Injector**

▼ OEM Reference

|     |             |    |             |    |             |
|-----|-------------|----|-------------|----|-------------|
| AC  | 16600-GS17B | KO | A6600-FU471 | MB | 91H20-16690 |
| CT  | 90425-08560 | KO | A6600-FU571 | MB | 91H20-16690 |
| CT  | 90425-18040 | KO | 16600-GS17B | MB | 16600-GS07B |
| CT  | 91H20-06690 | KO | 8779367     | NI | A6600-FU471 |
| CT  | 91H20-15230 | KO | 16600-GS07A | NI | A6600-FU571 |
| CT  | 91H20-16690 | KO | 16600-GS07B | NI | 16600-GS17B |
| HAM | A6600-FU471 | MB | 90425-08560 | TC | A6600-FU471 |
| HAM | A6600-FU571 | MB | 90425-18040 | TC | A6600-FU571 |
| HM  | 16600-GS07C | MB | 91H20-15230 |    |             |



Part Number - 380030-152

**Fuel Pressure Sensor**

▼ OEM Reference  
 CT 90425-18080  
 NI 16638-GX11A



Part Number - 380030-214

**Valve Assembly**

▼ OEM Reference  
 CT 91A65-00600  
 MB 91A65-00600  
 NI 17904-FC300



Part Number - 380051-007

**LPG Switch**

▼ OEM Reference  
 NI 17908-FC00D



Part Number - 380030-297

**Element Kit - LPG Filter (Asian)**

▼ OEM Reference  
 TY 04236-U2020-71

Note: Filter in this kit is PN 380030-292.

Part Number - 380030-292

**Element - Filter (Asian)**

▼ OEM Reference  
 HY 3004371  
 HY 3040365  
 TY 23644-26600-71  
 TY 23644-U2170-71

Note: This filter is included in kit 380030-297.



Part Number - 380104-927

**Fuel Pressure Sensor**

▼ OEM Reference

|    |             |    |             |
|----|-------------|----|-------------|
| AC | 8772247     | KO | 16197-FU46A |
| AC | 8777427     | KO | 16197-FU461 |
| CT | 90425-18250 | NI | 16197-FU46A |
| KM | 8772247     |    |             |

**Now Available:**



**Disinfectant Wipes**  
 See Page 1.10



**35 lb. Grease Pump**  
 See Page 1.06



**Portable Steel Hopper**  
 See Page 3.15



Part Number - 380005-003-01

**Starter F2, FE & VA  
(OEM part)**

Teeth (8)



▼ OEM Reference

HY 1534424      YT 580040914  
HY 2314322      YT 918139600

Part Number - 380005-019-01

**Starter 4P, 4Y, 5P & 5R**

Teeth (9)



▼ OEM Reference  
TY 28100-36770-71

Part Number - 380005-011-02

**Starter F2, FE & VA**

Teeth (8)



▼ OEM Reference

HY 1534424-NEW      YT 580040914-NEW  
HY 2314322-NEW      YT 918139600-NEW  
TC TFFSC18400-NEW

Part Number - 380105-187

**Starter 4Y, 12 Volt**

Teeth (9)



▼ OEM Reference

TC 212T1-07201-N      TY 28300-22003-71N  
TY 28100-20553-71N      TY 90928-29006-71N

Part Number - 380005-016-01

**Starter F2, FE & VA**

Teeth (8)



▼ OEM Reference

HY 1362069      YT 912978600  
TC TFES18400

Part Number - 380105-167

**Starter GM 4.3L**

Teeth (10)



▼ OEM Reference

HY 1383240-NEW  
YT 580006456-NEW

Part Number - 380005-017-01

**Starter F2, FE & VA**

Teeth (11)



▼ OEM Reference

HY 388040  
YT 900540857

Part Number - 380005-002-01

**Starter 4P, 4Y, 5P, 5R,  
GM 4 Cyl & GM 6 Cyl  
(OEM part)**

Teeth (9)



▼ OEM Reference

TC 212T1-07201      TY 28300-22003  
TY 28100-20553-71      TY 90928-29006-71  
TY 28100-20553

Part Number - 380105-174

**Starter GM 4.3L**

Teeth (11)



▼ OEM Reference

CL 933606-NEW      DW A232158-NEW      YT 580074751-NEW  
CT 91920-04400      HY 1640531-NEW  
CT 91920-14400      MB 91920-14400

Part Number - 380005-005-02

**Starter GM 3.0L**  
Teeth (11)



▼ OEM Reference

|                |             |              |
|----------------|-------------|--------------|
| CL 2817056     | HY 1391321  | SB 8156144   |
| CL 925874      | HY 1457047  | YT 220044332 |
| CL 930707      | HY 1486530  | YT 580000049 |
| CL 933605      | HY 1650426  | YT 580002210 |
| CT A0000-05846 | JU 50018782 | YT 580019725 |
| HY 1374621     | JU 50137926 | YT 580077957 |

Part Number - 380005-004-01

**Starter 4G63 & 4G64 (OEM part)**  
Teeth (10)



▼ OEM Reference

|             |             |             |
|-------------|-------------|-------------|
| CL 920971   | DW A218315  | MD 320618   |
| CT MD320618 | MB MD320618 | NI MD320618 |

Part Number - 380005-009-02

**Starter GM 2.4L**  
Teeth (9)



▼ OEM Reference

|             |              |              |
|-------------|--------------|--------------|
| HY 1548620  | HY 80-1406   | HY 9000890   |
| HY 300-1555 | HY 800136352 | YT 580044885 |

Part Number - 380005-018-01

**Starter 4G32, 4G33, 4G52 & 4G54**  
Teeth (8)



▼ OEM Reference

|             |             |             |
|-------------|-------------|-------------|
| CL 909329   | CT MM115517 | MB MD189054 |
| CL 3790819  | KO 4920209  | MB MM115514 |
| CT MM115514 | MB 909329   | MB MM115517 |
| CT MD189054 |             |             |

Part Number - 380005-008-02

**Starter K21 & K25 (OEM part)**  
Teeth (9)



▼ OEM Reference

|                |                |                  |
|----------------|----------------|------------------|
| AC 8772272     | KO 23300-FU410 | MB 91H20-03330   |
| CT 91H20-03330 | KO 23300-GS20A | NI 23300-FU410   |
| CT 91H20-06190 | KO 23300-GS20C | TC N-23300-FU410 |

Part Number - 380005-001-01

**Starter H20, H20II & H25 (OEM part)**  
Teeth (9)



▼ OEM Reference

|                |                |
|----------------|----------------|
| AC 4967525     | NI 23300-K9160 |
| KO 23300-K9160 | TC 23300-K9160 |

Part Number - 380005-015-01

**Starter K21 & K25**  
Teeth (9)



▼ OEM Reference

|                    |                |                  |
|--------------------|----------------|------------------|
| AC 8772272         | KO 23300-FU410 | MB 91H20-06190   |
| CT 91H20-03330     | KO 23300-GS20A | NI 23300-GS20A-N |
| CT 91H20-06190-NEW | KO 23300-GS20C |                  |
| KM 8772272-NEW     | MB 91H20-03330 |                  |

Starters

Part Number - 380005-006-01

**Starter A15, H20 & J15 (OEM part)**

Teeth (8)



▼ OEM Reference

|                |                |                |
|----------------|----------------|----------------|
| AC 4942421     | MB M3T21882D   | NI 23300-L2911 |
| AC 4948522     | NI 23300-00H10 | NI 23300-L2912 |
| KO 23300-00H10 | NI 23300-00H11 | TC 23300-00H10 |
| KO 23300-00H11 | NI 23300-L2910 |                |

Part Number - 380005-012-02

**Starter Yanmar 2.6L & 3.3L Diesel**

Teeth (9)



▼ OEM Reference

|                |                    |
|----------------|--------------------|
| CL 8023898     | KO YM129900-77010N |
| HY 1599845-NEW | YT 580062748-NEW   |
| KM 8762412-NEW |                    |

Part Number - 380005-013-02

**Starter TB42**

Teeth (9)



▼ OEM Reference

|                  |                  |
|------------------|------------------|
| CT 90425-02580-N | NI 23300-52H00-N |
| KM 4968855-NEW   |                  |

Part Number - 380005-014-02

**Starter C240 Diesel**

Teeth (9)



▼ OEM Reference

|                |
|----------------|
| HY 1519632-NEW |
| HY 1519632     |

Part Number - 380105-204

**Starter White 1404**

Teeth (10)



▼ OEM Reference

|               |                |               |
|---------------|----------------|---------------|
| CL 930031-NEW | DW A213980-NEW | MB 6T7004-NEW |
| DW A213980    | DW D141291     |               |

Starter Replacement Parts



Part Number - 380005-050

**Starter Drive**

▼ OEM Reference

|               |
|---------------|
| HY 2314328    |
| TC TB63018X45 |
| YT 9023618-06 |



Part Number - 380005-051

**Starter Solenoid**

▼ OEM Reference

|            |                  |              |
|------------|------------------|--------------|
| HM 520     | HY 2314342       | YT 901286817 |
| HM 555     | TC T-4894-24-760 | YT 901991817 |
| HY 1368862 | TC TFES18X10     | YT 902361820 |
| HY 1574092 | YT 580053798     |              |



Part Number - 380006-001-02

**Water Pump H20 New Style**

▼ OEM Reference

|                |                |                   |
|----------------|----------------|-------------------|
| AC 4942349     | KO 21010-L1125 | NI 21010-L1128    |
| AC 4969885     | KO 21010-L1126 | TC 21010-20H25    |
| CL 7000507     | KO 21010-L1128 | TC 21010-78226    |
| CT 0971264     | KO 64-101      | TC N-21010-L1100  |
| CT 971264      | NI 21010-20H25 | TC N-21010-L1125  |
| HY 3041677     | NI 21010-78226 | TC N-21010-L1126  |
| HY 3045360     | NI 21010-L1100 | TY 00591-07978-81 |
| KO 21010-78226 | NI 21010-L1101 | TY 00591-32887-81 |
| KO 21010-L1100 | NI 21010-L1125 | TY 00591-50484-81 |
| KO 21010-L1101 | NI 21010-L1126 | YT 220007606      |



Part Number - 380106-057

**Water Pump F2**



▼ OEM Reference

|                |                   |                   |
|----------------|-------------------|-------------------|
| AC 64-702      | HY 865434         | TY 00591-34280-81 |
| CT 14411860    | JU 14411860       | TY 00591-54103-81 |
| CT A0000-02548 | KO 64-702         | YT 150118724      |
| HY 0865434     | LP 126-9039       | YT 220019096      |
| HY 1582588     | MB 14411860       | YT 524242078      |
| HY 2028644     | MB A0000-02548    | YT 901579801      |
| HY 2078488     | TC T-8AK1-15-010  |                   |
| HY 3122609     | TY 00591-11107-81 |                   |



Part Number - 380006-002-02

**Water Pump K21 & K25**

Includes 8 fins; the impeller is flush with the housing

▼ OEM Reference

|                |                |                |
|----------------|----------------|----------------|
| AC 8761949     | KO 21010-FU40J | NI 21010-FU425 |
| CT 91H20-02580 | NI 21010-FU40J | YT 220024192   |
| DW D490720     | NI 21010-FU400 |                |



Part Number - 380006-005-02

**Water Pump 4G63 & 4G64**

▼ OEM Reference

|             |             |
|-------------|-------------|
| CL 1232510  | DW A218276  |
| CT 1041579  | MB MD970338 |
| CT MD970338 | MB MD972457 |
| CT MD972457 |             |



Part Number - 380006-003-02

**Water Pump HER2.7 & 1404**

▼ OEM Reference

|             |                 |                   |
|-------------|-----------------|-------------------|
| AC 4948821  | DW 2W8554       | KO HE40-2035079   |
| CT 1W0404   | DW 4W1583       | MB 9Y5969         |
| CT 1W404    | DW 9Y5969       | MB D700615        |
| CT 4W1583   | DW D700615      | MB MCF00036       |
| CT 9Y5969   | HY 402035079    | NI D700615        |
| CT D700615  | KO HE40-2035063 | TY 00591-05705-81 |
| CT MCF00036 | KO HE40-2035078 | YT 220007160      |



Part Number - 380006-006-02

**Water Pump GM 3.0L**

▼ OEM Reference

|                   |
|-------------------|
| CL 924942         |
| DW A218653        |
| HY 388365         |
| TY 16100-U2120-71 |



Part Number - 380006-007-02

**Water Pump 4Y 5 & 6 Engines**

▼ OEM Reference

|                   |                   |                   |
|-------------------|-------------------|-------------------|
| CL 446097         | TY 00591-32889-81 | TY 16120-96151-71 |
| HY 3046758        | TY 00591-53193-81 | YT 220010746      |
| TY 00591-10723-81 | TY 16120-78151-71 |                   |



Part Number - 380006-004-02

**Water Pump FE**

▼ OEM Reference

|             |                   |               |
|-------------|-------------------|---------------|
| CL 7000511  | JU 14520447       | YT 220079608  |
| HY 1361811  | MZ FE7915010C     | YT 5059605-79 |
| HY 2022312  | TY 00591-22426-81 | YT 901302802  |
| JU 14365400 | TY 00591-32891-81 |               |
| JU 14365450 | TY 00591-61180-81 |               |



Part Number - 380006-009-02

**Water Pump VA**

▼ OEM Reference

|            |                   |                   |
|------------|-------------------|-------------------|
| CT 219273  | HY 326774         | TY 00591-54109-81 |
| HY 1339931 | HY 326779         | YT 220007409      |
| HY 1376005 | TY 00591-34296-81 |                   |
| HY 3002535 |                   |                   |



Part Number - 380006-010-02

**Water Pump 4Y 7 Series**

▼ OEM Reference

|                   |
|-------------------|
| TC 212T1-09451    |
| TY 16110-78156-71 |

**Note:** All water pumps include gasket.

## Pumps



Part Number - 380006-011-02

**Water Pump H20II & H25**

Includes 6 fins; the impeller is raised out from the housing

## ▼ OEM Reference

|                |                |                   |
|----------------|----------------|-------------------|
| AC 8772259     | KO 21010-50K28 | LP 126-9087       |
| CT A0000-00429 | KO 21010-50K29 | TC N-21010-50K26  |
| HY 3132592     | KO 21010-FF225 | TC N-21010-50K28  |
| HY 3142317     | KO 21010-P7526 | TY 00591-21011-81 |
| KO 21010-50K01 | KO 64-102      | TY 00591-34284-81 |
| KO 21010-50K02 | KO 8772259     | TY 00591-54104-81 |
| KO 21010-50K26 | LP 126-9040    | YT 220043217      |



Part Number - 380006-016-01

**Orbitrol Steering Gear Pump**

## ▼ OEM Reference

|                |                |                |
|----------------|----------------|----------------|
| CT 93E54-00200 | NI 49410-6G000 | NI 49410-91H01 |
| MB 93E54-00200 | NI 49410-6G401 |                |



Part Number - 380006-017-01

**Orbitrol Steering Gear Pump**

## ▼ OEM Reference

|                |                |                |
|----------------|----------------|----------------|
| CT 91B54-00200 | NI 49410-FC300 | NI 49410-FJ500 |
| MB 91B54-00200 | NI 49410-FJ100 | NI 49410-FK000 |
| NI 49410-FC300 |                |                |



Part Number - 380006-012-01

**Hydraulic Pump (Lift)**

## ▼ OEM Reference

RA 1032206



Part Number - 380006-014-01

**Hydraulic Pump**

## ▼ OEM Reference

HN 31FN-01000



Part Number - 380006-015-01

**Hydraulic Pump**

## ▼ OEM Reference

KO 37B-1KA-5021  
 KO 37B-1KA-A712  
 KO 37B-1KC-5022



Part Number - 380006-018-01

**Orbitrol Steering Gear Pump**

## ▼ OEM Reference

|              |              |
|--------------|--------------|
| HY 2056868   | YT 580037271 |
| YT 580037270 | YT 580043152 |



Part Number - 380006-019-01

**Orbitrol Steering Gear Pump**

## ▼ OEM Reference

RA 1008426



Part Number - 380006-020-01

**Orbitrol Steering Gear Pump**

## ▼ OEM Reference

TC 15604-10202  
 TC HC32G4-10101

**Note:** All water pumps include gasket.

## Pump Parts



Part Number - 380006-021

**Water Pump Gasket**

## ▼ OEM Reference

TY 16124-78156-71



Part Number - 380030-309

**Water Pump Kit - Cover**

## ▼ OEM Reference

TY 90904-U9002-71



Part Number - 380006-022

**Water Pump Gasket**

## ▼ OEM Reference

YT 901579805

Note: For use with Mazda / 2.2 Engine



Alternator Plug Reference Diagram

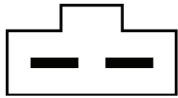

Plug E



Plug G

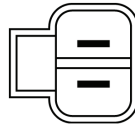

Plug H

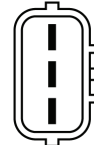

Plug J



Plug K

Part Number - 380011-001-01

**Alternator H20 II, H25, TB42 (OEM part), 12 Volt, 35 Amp**

■ Plug H

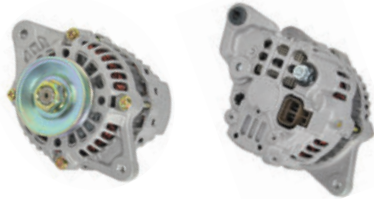

▼ OEM Reference

|                |                |                |
|----------------|----------------|----------------|
| AC 8762055     | KO 8762055     | NI 23100-87V10 |
| AC 8775058     | KO 8775058     |                |
| CT 90425-02410 | MB 90425-02410 |                |

Part Number - 380011-004-02

**Alternator A15, D5, FE, F2, H20, P40, TB42, 4FE1 Diesel & S4S Diesel, 12 Volt, 35 Amp**

■ Plug G



▼ OEM Reference

|                |                |                   |
|----------------|----------------|-------------------|
| AC 4949046     | HA LT135-68    | NI 23100-A5502    |
| BO 986032431   | HA LT135-69    | NI 23100-B8001    |
| BO 986033481   | HA LT150-25    | NI 23100-B8002    |
| CL 7000289     | HA LT150-25B   | NI 23100-B9802    |
| CT A0000-02071 | HC LT135-68    | NI 23100-B9810    |
| FL 2475677210  | HY 1310962     | NI 23100-B9810-B  |
| HA LT125-04    | HY 3020078     | NI 23100-E5200    |
| HA LT125-06B   | KO 23100-B9810 | NI 23100-H0100    |
| HA LT130-41K   | MB A1T20271    | NI 23100-H0110    |
| HA LT130-65    | MB A1T21171    | NI 23100-H0300    |
| HA LT130-72    | MB A1T22581    | NI 23100-H0310    |
| HA LT130-72B   | MB A1T24371    | NI 23100-M0400    |
| HA LT130-75    | MB AG2025A     | NI 23100-M0401    |
| HA LT135-13    | MB AG2030A     | NI 23100-M0402    |
| HA LT135-13B   | MB AG2035A     | NI 23100-M0410    |
| HA LT135-17B   | MB AG2035A2    | NI 23100-U0101    |
| HA LT135-19B   | MB AG2035N1    | NI 23100-U0111    |
| HA LT135-19C   | MB AH2035N1    | TC 53032-72601    |
| HA LT135-19E   | MZ GE01-18-300 | TC N-23100-B9810  |
| HA LT135-20    | NI 23100-06000 | TC N-23300-B9810  |
| HA LT135-24    | NI 23100-A4602 | TY 00591-33739-81 |
| HA LT135-35    | NI 23100-A4800 | TY 00591-55972-81 |
| HA LT135-35B   | NI 23100-A4810 | YT 150014500      |
| HA LT135-35C   | NI 23100-A5500 | YT 150022504      |
| HA LT135-54    | NI 23100-A5501 | YT 901285801      |

Part Number - 380011-002-01

**Alternator 4Y (OEM part) 12 Volt, 35 Amp**

■ Plug K



▼ OEM Reference

|                     |                   |                   |
|---------------------|-------------------|-------------------|
| KO TJ27060-78003-71 | TC 212T1-06941    | TY 27060-78003-71 |
| KO TJ270607800371   | TY 00591-10795-81 | TY 27060-78155-71 |
| ND 100211-4540      | TY 00591-50056-81 | YT 220042179      |

Part Number - 380011-005-01

**Alternator FE (OEM part) 12 Volt, 40 Amp**

■ Plug G



▼ OEM Reference

|               |              |
|---------------|--------------|
| HY 1361853    | YT 580000990 |
| HY 1450928-HD |              |

Part Number - 380011-003-02

**Alternator 4Y (OEM part) 12 Volt, 50 Amp**

■ Plug J



▼ OEM Reference

|                      |
|----------------------|
| TY 27060-78153-71    |
| TY 27060-78156-71    |
| TY 27060-78158-71    |
| TY 27060-UB030-71-HD |
| TY 27060-UB050-71    |

Part Number - 380011-006-02

**Alternator GM & Waukesha  
12 Volt, 63 Amp**

■ Plug E



▼ OEM Reference

|            |            |                   |
|------------|------------|-------------------|
| AC 4789142 | CL 908106  | PL 8AR2200L       |
| CL 2363677 | CL 908221  | SG 2383064        |
| CL 2383064 | CT 213346  | TY 00591-21035-81 |
| CL 2399509 | HY 3029189 | TY 00591-27362-81 |
| CL 2399511 | HY 3046654 | TY 00591-33616-81 |
| CL 6513962 | HY 385656  | YT 220005010      |
| CL 6599739 | JU 1470500 |                   |
| CL 905949  | JU 1470500 |                   |
| CL 907739  | PL 110-460 |                   |

Part Number - 380011-010-01

**Alternator 4G52 & 4G54  
(OEM part)  
12 Volt, 45 Amp**

■ Plug G



**Alternator 4G33  
(OEM part)  
12 Volt, 45 Amp**

■ Plug G

▼ OEM Reference  
CL 3768011

▼ OEM Reference  
CT MD034130  
MB MD034130

Part Number - 380011-007-02

**Alternator H20  
12 Volt, 35 Amp**

■ Plug G



▼ OEM Reference

|                |                |                   |
|----------------|----------------|-------------------|
| AC 4942402     | NI 23100-H7703 | NI 23100-U0114    |
| AC 4947935     | NI 23100-M0413 | NI 23100-U4601    |
| CT 971562      | NI 23100-M0414 | TC 23100-M0413    |
| KO 23100-C6000 | NI 23100-M6601 | TC 23100-U0103    |
| KO 23100-M0413 | NI 23100-U0100 | TC N-23100-C6000  |
| KO 23100-M0414 | NI 23100-U0102 | TC N-23100-M0413  |
| KO 23100-U0105 | NI 23100-U0103 | TC N-23100-M0414  |
| NI 23100-A4600 | NI 23100-U0104 | TC N-23100-U0100  |
| NI 23100-A4601 | NI 23100-U0105 | TC N-23100-U0102  |
| NI 23100-A4611 | NI 23100-U0110 | TC N-23100-U0103  |
| NI 23100-C6000 | NI 23100-U0112 | TY 00591-08089-81 |
| NI 23100-H6215 | NI 23100-U0113 |                   |

Part Number - 380011-011-01

**Alternator 4G52 & 4G54  
(OEM part)  
12 Volt, 50 Amp**

■ Plug G



▼ OEM Reference

|             |             |
|-------------|-------------|
| CL 3768023  | KM 4921289  |
| CT MD064068 | MB MD064068 |

Part Number - 380106-621

**Alternator 4Y  
12 Volt, 50 Amp**

■ Plug J



▼ OEM Reference  
TY 27060-78158-71N  
TY 27060-78160-71  
TY 27060-UB030-NEW

Part Number - 380011-008-01

**Alternator (OEM part)  
12 Volt, 40 Amp**

■ Plug Not Applicable

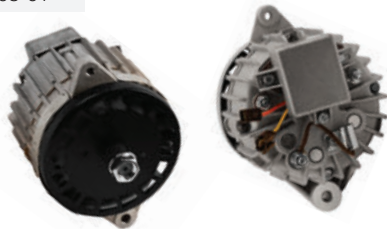

▼ OEM Reference

|              |
|--------------|
| HY 1394001   |
| YT 580073364 |
| YT 900017264 |

▲WARNING: Cancer and reproductive harm - www.P65Warnings.ca.gov

Part Number - 380011-009-01

**Alternator 4G64 & 4G63 (OEM part)  
12 Volt, 50 Amp**

■ Plug H



▼ OEM Reference

|             |             |
|-------------|-------------|
| CL 920244   | DW D187478  |
| CL 928179   | MB MD354809 |
| CT MD354809 |             |

Part Number - 380011-013-02

**Alternator H20II, H25 & TB42  
12 Volt, 50 Amps**

■ Plug H



▼ OEM Reference

|                |                 |                |
|----------------|-----------------|----------------|
| AC 23100-50K15 | HY 1720588      | MB A007T-03771 |
| AC 23100-FU410 | HY 76000743     | MB A007T-A3377 |
| AC 8772271     | KO 23100-50K15  | NI 23100-50K15 |
| CT 50460080    | KO 23100-FU410A | NI 23100-FF110 |
| CT 91H20-03270 | KO 8772271      | NI 23100-FU410 |
| CT A0000-14162 | MB 50460080     | NI 23100-FU41A |
| CT A007T-03771 | MB 91H20-03270  | YT 76000743    |
| CT A007T-A3377 | MB A0000-14162  |                |

## Alternators

Part Number - 380011-012-02

**Alternator FE**  
**12 Volt, 40 Amp**  
 ■ Plug G



▼ OEM Reference

HY 1361853R YT 150012758 YT 901948801  
 HY 1450928 YT 505960560  
 JU 14485060 YT 580000990

Part Number - 380100-117

**Alternator**  
**12 Volt, 35 Amp**  
 ■ Plug H



▼ OEM Reference

AC 8762055 KO 8762055 NI 23100-87V10-N  
 AC 8775058 KO 8775058  
 CT 90425-02410-N MB 90425-02410-N

## Radiators and Accessories

Continued ▶



Part Number - 380009-001-02

**Radiator**

▼ OEM Reference  
 AC 8761212  
 KO 3EB-04-A5111

**Replacement Cap:** 380009-104



Part Number - 380009-007-02

**Radiator K21-K25**

▼ OEM Reference  
 KO 3EB-04-A6110

**Replacement Cap:** 380009-104



Part Number - 380009-003-02

**Radiator**

▼ OEM Reference  
 NI 21460-90H15  
 NI 21460-90H15-D

**Replacement Cap:** 380009-104



Part Number - 380009-008-02

**Radiator**

▼ OEM Reference  
 KO 3EA-04-51110

**Replacement Cap:** 380009-104



Part Number - 380009-004-02

**Radiator**

▼ OEM Reference  
 NI 21460-6G000  
 NI 21460-6G100  
 NI 21460-6G101  
 NI 21460-G6000

**Replacement Cap:** 380009-104



Part Number - 380009-009-01

**Radiator (OEM part)**

▼ OEM Reference  
 TY 16410-F1100-71  
 TY 16410-U2200-71  
 TY 16410-U2201-71  
 TY 16420-U1280-71

**Replacement Cap:** 380104-494



Part Number - 380009-005-02

**Radiator**

▼ OEM Reference  
 CT A0000-12933  
 TY 16410-23010-71  
 TY 16410-23070-71  
 TY 16410-U2000-71

**Replacement Cap:** 380009-104



Part Number - 380009-110-02

**Radiator**

▼ OEM Reference  
 TY 16410-U1130-71

**Replacement Cap:** 380009-104



Part Number - 380009-006-02

**Radiator**

▼ OEM Reference  
 NI 21460-24H10  
 NI 21460-90H10

**Replacement Cap:** 380009-104



Part Number - 380009-111-01

**Radiator (OEM part)**

▼ OEM Reference  
 HY 4603553 YT 580057495  
 YT 580044218 YT 582003828

**Replacement Cap:** 380009-102



Part Number - 380009-112-01

**Radiator (OEM part)**

▼ OEM Reference  
FC 290-1293  
HY 2056870  
LP 290-1293

**Replacement Cap:** 380009-102



Part Number - 380009-122-01

**Radiator (OEM part)**

▼ OEM Reference  
HY 4603554  
YT 582003829

**Replacement Cap:** 380009-102



Part Number - 380009-114-01

**Radiator (OEM part)**

▼ OEM Reference  
TY 16410-U2130-71

**Replacement Cap:** 380009-104



Part Number - 380009-123-01

**Radiator (OEM part)**

▼ OEM Reference  
HY 2054879  
YT 580035647

**Replacement Cap:** 380009-102



Part Number - 380009-116-01

**Radiator (OEM part)**

▼ OEM Reference  
HY 2060012

**Replacement Cap:** 380009-102



Part Number - 380104-444

**Radiator, Aluminum**

▼ OEM Reference  
CT A0000-27676 TY 16410-U2170-71 TY 16420-U3500-71  
CT A0000-29270 TY 16410-U2171-71 TY 16450-23430-71  
MB A0000-27676 TY 16420-F2100-71 TY 16460-23430-71  
MB A0000-29270 TY 16420-U2170-71 TY 16460-U2230-71  
TY 16410-F2100-71 TY 16420-U2230-71

**Replacement Cap:** 380104-494



Part Number - 380009-117-01

**Radiator (OEM part)**

▼ OEM Reference  
NI 21450-FC00A

**Replacement Cap:** 380009-104



Part Number - 380009-118-01

**Radiator (OEM part)**

▼ OEM Reference  
HY 1388911  
YT 580002232

**Replacement Cap:** 380104-493



Part Number - 380106-436

**Radiator**

▼ OEM Reference  
CT 93E01-00010  
MB 93E01-00010

**Replacement Cap:** 380009-104



Part Number - 380009-119-01

**Radiator (OEM part)**

▼ OEM Reference  
HY 4606206  
YT 582006670

**Replacement Cap:** 380009-102



Part Number - 380104-468

**Radiator**

▼ OEM Reference  
CT A0000-19618 HY 2035469 MB A0000-28106  
CT A0000-27667 HY 2037315 YT 520035884  
CT A0000-28101 HY 2038182 YT 520035896  
CT A0000-28106 HY 2038183 YT 524140817  
HY 1375908 HY 2057820 YT 580003258  
HY 1375909 MB A0000-19618 YT 580013390  
HY 1379810 MB A0000-27667 YT 580013391  
HY 2000153 MB A0000-28101 YT 580037662

**Replacement Cap:** 380009-102



Part Number - 380009-120-01

**Radiator (OEM part)**

▼ OEM Reference  
HY 2066914  
NI 21450-FK30A  
YT 524205368

**Replacement Cap:** 380009-104



Part Number - 380009-100  
**Lower Hose**  
 ▼ OEM Reference  
 HY 2064054  
 YT 580044223



Part Number - 380009-101  
**Upper Hose**  
 ▼ OEM Reference  
 HY 2064053  
 YT 580044222



Part Number - 380009-107  
**Lower Hose**  
 ▼ OEM Reference  
 KO 3EB-04-23220    KO 3EB-04-A5122    KM 8761217  
 KO 3EB-04-A5121    KM 4949229



Part Number - 380009-108  
**Upper Hose**  
 ▼ OEM Reference  
 TY 16511-12810-71    KO 3EB-04-A5131    KM 8761218  
 TY 16511-16640-71    KO 3EB-04-A5132



Part Number - 380009-113  
**Lower Hose**  
 ▼ OEM Reference  
 AC 8777796  
 KO 3EB-04-A7511



Part Number - 380009-110  
**Upper Hose**  
 ▼ OEM Reference  
 KO 8777797    KO 3EB-04-A7520  
 KO 8779168    KO 3EB-04-A7521



Part Number - 380009-125  
**Lower Hose**  
 ▼ OEM Reference  
 TY 16512-22810-71  
 TY 16512-23420-71  
 TY 16512-26600-71



Part Number - 380009-124  
**Upper Hose**  
 ▼ OEM Reference  
 TY 16511-23340-71  
 TY 16511-26600-71



Part Number - 380009-130  
**Lower Hose**  
 ▼ OEM Reference  
 TY 16512-12800-71  
 TY 16512-16640-71



Part Number - 380009-129  
**Upper Hose**  
 ▼ OEM Reference  
 TY 16511-12800-71



Part Number - 380104-580  
**Radiator Hose (Lower)**  
 ▼ OEM Reference  
 CT 91B01-10400    MB 91B01-10400    NI 21503-FJ101  
 CT 93E01-00300    MB 93E01-00300    TY 800129308  
 CT 91B01-00400    MB 91B01-00400  
 HY 800129308    NI 21503-FJ100



Part Number - 380009-109  
**Bypass Hose**  
 ▼ OEM Reference  
 CT 91H20-02770    KA 8761960    NI 14080-50K00  
 DA D490732    MI 91H20-02770



Part Number - 380104-596  
**Radiator Hose (Lower)**  
 ▼ OEM Reference  
 HY 2059211    YT 580038861  
 HY 2074397    YT 580056738



Part Number - 380009-128  
**Bypass Hose**  
 ▼ OEM Reference  
 TY 16261-78154-71



Part Number - 380104-663  
**Radiator Hose (Upper)**  
 ▼ OEM Reference  
 CT 93B01-00200    CT 93E01-10200    MB 93E01-00200  
 CT 93B01-10200    MB 93B01-00200    MB 93E01-10200  
 CT 93E01-00200    MB 93B01-10200

**Radiators and Accessories**



Part Number - 380009-104

**Radiator Cap**

▼ OEM Reference

|                |                  |                   |
|----------------|------------------|-------------------|
| AC 4949074     | KM 4949074       | NI 21430-FK300    |
| AC 8761209     | KM 8761209       | TC 222A2-10211    |
| CL 925303      | KO CPC89C0025010 | TY 16401-23000-71 |
| CL 926014      | KO CPC89C0175010 | TY 16401-U2000-71 |
| CT 42713-30600 | NI 21430-01F02   | YT 901900802      |
| HY 2022397     | NI 21430-91H00   | YT 901913802      |



Part Number - 380009-105

**Thermostat/Gasket**  
H2O II Engines 170°

▼ OEM Reference

|                    |                  |                 |
|--------------------|------------------|-----------------|
| AC 8761954         | KO 21200-50K00   | NI 21200-96015  |
| AC 8772261         | KO 21200-53J00   | NI 21200-96061  |
| CT 32A46-02100     | KO 21200-VJ200   | NI 21200-OC811  |
| CT 91H20-02680     | KO 21200-VJ200K0 | NI 21200-VJ200  |
| HY 301793          | KO 600-421-6110  | NI 21200-VJ200D |
| KM 8761954         | KO 600-421-6210  | NI 21200-VJ200N |
| KO 01NI21200-VJ200 | KO 6140-11-6310  | NI 21200-VJ200S |
| KO 21200-OC811     | NI 21200-58G04   | TUSK 8761954    |



Part Number - 380009-102

**Radiator Cap**

▼ OEM Reference

|              |
|--------------|
| HY 1352140   |
| YT 505972563 |



Part Number - 380009-126

**Thermostat Gasket**

▼ OEM Reference

|            |
|------------|
| HY 1330725 |
|------------|



Part Number - 380030-120

**Thermostat/O-Ring, 4Y Engine, 170°**

▼ OEM Reference

|                |                   |
|----------------|-------------------|
| TC 212T1-08481 | TY 90916-03950-71 |
| TY 9001A-97002 |                   |

**Replacement Gasket:** 380009-127



Part Number - 380009-127

**Thermostat Gasket**

▼ OEM Reference

|                   |
|-------------------|
| TY 16341-76017-71 |
|-------------------|



Part Number - 380009-106

**Thermostat/Gasket**  
A15, J15, H2O Engines 180°

▼ OEM Reference

|                |                   |                   |
|----------------|-------------------|-------------------|
| CL 907438      | HY 151570         | TY 80916-76085-71 |
| CL 911166      | HY 231522         | TY 90916-03037    |
| CL 913788      | HY 324370         | TY 90916-03954-71 |
| CL 920235      | KM 4920199        | YT 524253576      |
| CT 91920-05100 | KM 4942370        | YT 580000179      |
| DW A218287     | NI 21200-G3100    | YT 580000381      |
| HY 1361820     | TY 16302-U2120-71 | YT 580024168      |
| HY 1450643     | TY 80916-76032-71 | YT 901282847      |
| HY 1450696     | TY 80916-76033-71 |                   |
| HY 1495428     | TY 80916-76065-71 |                   |

**Replacement Gasket:** 380009-126



Part Number - 380009-103

**Thermostat/O-Ring**  
GM 2.4L Engines 192°

▼ OEM Reference

|              |
|--------------|
| HY 1584121   |
| YT 580056945 |



Part Number - 380009-132

**Thermostat**

▼ OEM Reference

|              |
|--------------|
| HY 4111238   |
| YT 582041305 |



Part Number - 380020-008-02-R

**Shoe - Right Hand (2)**

- ▼ OEM Reference
- HY 1565314
- KO 3EB-K3-0204C
- YT 580051333
- YT 524248309



Part Number - 380020-008-02-L

**Shoe - Left Hand (2)**

- ▼ OEM Reference
- HY 1565313
- KO 3EB-K3-0203C
- YT 580051332
- YT 524248308



Part Number - 380020-001-02

**Brake Shoe Kit (4)**

- ▼ OEM Reference
- KO 3EB-30-A31180
- NI 44999-22H00
- TY 00591-27305-81
- TY 00591-34821-81
- TY 00591-43054-81
- TY 00591-57969-81



Part Number - 380020-002-02

**Brake Shoe (2)**

A pin is included in this kit to make it adaptable for RH or LH use. Kit includes 2 shoes to do one side of the truck. Need to order 2 kits if doing both sides.

- ▼ OEM Reference
- TC 20803-71151
- TC 20803-71161
- KO 3EA-30-1144C
- KO 3EA-30-1145C
- TY 47510-U113071
- TY 47520-U113071



Part Number - 380020-003-02

**Brake Shoe (2)**

- ▼ OEM Reference
- HY 1334620
- YT 1500132-07
- YT 5059595-61
- HY 1363007



Part Number - 380020-004-02

**Brake Shoe (1)**

- ▼ OEM Reference
- AC 8761527
- AC 8761528
- AC 8761529
- CT 91446-17100
- CT 91546-12500
- CT 91546-12600
- KO 3EB-30-31150
- KO 3EB-30-31160
- KO 3EB-30-31170
- NI 44060-22H60
- NI 44070-22H60
- NI 44070-22H70
- TY 47503-3386071
- TY 47504-3386071
- TY 47505-3386071
- TY 47512-3306071



Part Number - 380020-019-01

**Brake Shoe (1)**

- ▼ OEM Reference
- AC 4940527
- AC 4940532
- AC 4940535
- CT 91B46-10313
- CT 91B46-10314
- CT 91B46-10412
- DW A273363
- DW A273364
- DW A273365
- KO 32532-21500
- KO 32532-21600
- KO 3EA-30-11410
- KO 3EA-30-11420
- KO 3EA-30-11430
- KO 3EA-30-31150
- KO 3EA-30-31160
- MB 91246-16800
- MB 91246-16900
- MB 91246-17100
- NI 44060-00H00
- NI 44060-00H60
- NI 44060-11H03
- NI 44060-11H06
- NI 44060-FJ500
- NI 44060-LO105
- NI 44070-00H60
- NI 44070-00H70
- NI 44070-0K301
- NI 44070-0K311
- NI 44070-11H06
- NI 44070-11H16
- NI 44070-FJ500
- NI 44070-FJ510
- TY 47403-12810-71
- TY 47403-13300-71
- TY 47403-16600-71
- TY 47404-12810-71
- TY 47404-13300-71
- TY 47404-16600-71
- TY 47405-12810-71
- TY 47405-13000-71
- TY 47405-13300-71
- TY 47405-16600-71
- TY 47505-13000-71
- TY 47506-13000-71



Part Number - 380020-006-02

**Brake Shoe (2)**

- ▼ OEM Reference
- HY 1334640
- HY 1358223
- TC 22433-79901
- YT 505963591
- YT 580032688
- YT 918259300
- YT 930132400
- TC CK21122083000
- KO 3EB-30-2300K
- KO 3EB-30-23450



Part Number - 380020-007-02

**Brake Shoes (4)**

- ▼ OEM Reference
- NI 44999-00H00
- NI 44999-11H00
- NI 44999-L1400



Part Number - 380020-010-02

**Brake Shoe (2)**

- ▼ OEM Reference
- CL 932683
- CL 932684
- KO 3EB-30-3158C
- KO 3EB-30-3159C
- TY 47510-U2130-71
- TY 47520-U2130-71



Part Number - 380020-011-02  
**Brake Shoe (2)**

▼ OEM Reference

|            |                  |                 |
|------------|------------------|-----------------|
| HY 1463226 | KM 8761128       | KO 3EC-30-11840 |
| HY 1463229 | KO 3EC-30-11601  | YT 580011203    |
| HY 2047122 | KO 3EC-30-1162LH | YT 580011206    |
| HY 2047123 | KO 3EC-30-1172RH | YT 902392851    |
| KM 8761124 | KO 3EC-30-11830  | YT 902392861    |



Part Number - 380020-016-01  
**Brake Shoes (4)**

▼ OEM Reference  
NI 44999-FK000



Part Number - 380020-017-02  
**Brake Shoe (1)**

▼ OEM Reference

|                   |                   |
|-------------------|-------------------|
| TC 22673-72022    | TY 47405-22550-71 |
| TC 47405-23600-71 | TY 47405-23600-71 |
| TY 47401-33240-71 | TY 47405-33660-71 |



Part Number - 380020-012-02  
**Brake Shoe (2)**

▼ OEM Reference

|              |
|--------------|
| HY 2026303   |
| HY 2026787   |
| YT 915046300 |
| YT 927113300 |
| YT 929151300 |



Part Number - 380020-020-01  
**Brake Shoe (1)**

▼ OEM Reference

|                 |                |
|-----------------|----------------|
| CT 91E46-00113  | MB 91E46-00113 |
| KO 3EB-30-41360 | NI 44060-FK000 |



Part Number - 380020-013-02  
**Brake Shoe (2)**

▼ OEM Reference

|              |
|--------------|
| HY 1591664   |
| YT 580059824 |



Part Number - 380020-018-02  
**Brake Shoe (1)**

▼ OEM Reference

|                  |                 |                   |
|------------------|-----------------|-------------------|
| CT 91846-17200   | KM 8765282      | TY 47403-23300-71 |
| CT 91846-17300   | KO 3EC-30-11611 | TY 47404-23300-71 |
| CT 91846-17400   | KO 3EC-30-11621 | TY 47405-23300-71 |
| HAM 3EC-30-11810 | KO 3EC-30-11721 | TY 47504-22752-71 |
| HAM 8765280      | KO 3EC-30-11810 | TY 47505-22752-71 |
| KM 8765280       | KO 3EC-30-11820 | TY 47506-22752-71 |
| KM 8765281       | KO 3EC-30-11920 |                   |



Part Number - 380020-014-02  
**Brake Shoe (2)**

▼ OEM Reference

|              |
|--------------|
| HY 1591665   |
| YT 580059825 |



Part Number - 380100-894  
**Brake Shoe (1)**

▼ OEM Reference

|                 |
|-----------------|
| CT 91E46-00212  |
| KO 3EB-30-41380 |
| MB 91E46-00212  |
| NI 44070-FK000  |



Part Number - 380020-015-02  
**Brake Shoe (1)**

▼ OEM Reference

|                 |                 |                   |
|-----------------|-----------------|-------------------|
| KM 4940946      | KO 3EB-30-23440 | TY 47403-32062-71 |
| KM 4940947      | KO 3EB-30-24430 | TY 47404-32062-71 |
| KO 3EB-30-23430 | KO 3EB-30-24440 |                   |



Part Number - 380100-895  
**Brake Shoe (1)**

▼ OEM Reference

|                 |
|-----------------|
| CT 91E46-00114  |
| KO 3EB-30-41370 |
| MB 91E46-00114  |
| NI 44070-FK010  |





Part Number - 380100-896

**Brake Shoe (1)**

▼ OEM Reference  
TY 47403-26640-71



Part Number - 380100-898

**Brake Shoe (1)**

▼ OEM Reference  
TY 47405-26640-71



Part Number - 380023-021

**Brake Drum**

▼ OEM Reference  
KO 3EB-21-25310  
KO 3EB-21-42230



Part Number - 380030-031

**Spring**

▼ OEM Reference

|                 |                   |                   |
|-----------------|-------------------|-------------------|
| CT 91246-04500  | NI 44147-00H00    | TY 47472-U1130-71 |
| KM 4940538      | NI 44147-11H04    |                   |
| KO 3EA-30-11340 | TY 47472-11631-71 |                   |



Part Number - 380030-024

**Spring**

▼ OEM Reference

|                |                 |                   |
|----------------|-----------------|-------------------|
| AC 4942534     | KO 4942534      | NI 44090-22H10    |
| CL 932573      | KO 4942606      | TY 47434-32500-71 |
| CT 91846-14100 | KO 4968244      | TY 47438-33060-71 |
| KM 4942534     | KO 34B-30-14351 | TY 47438-U3130-71 |
| KO 4941616     | KO 3EC-30-11350 |                   |



Part Number - 380030-057

**Spring**

▼ OEM Reference

|                 |                  |                   |
|-----------------|------------------|-------------------|
| CT 91246-03400  | NI 44070-L0100   | TY 47635-10110-71 |
| KM 4941373      | NI 44090-L1400   | TY 47675-11630-71 |
| KO 300-32-31760 | TC C521100304010 | TY 47675-U1130-71 |



Part Number - 380030-059

**Spring**

▼ OEM Reference

|                 |                   |                   |
|-----------------|-------------------|-------------------|
| CL 932574       | MB 91446-03900    | TY 47438-U2130-71 |
| KM 4942605      | NI 44090-22H00    |                   |
| KO 3EC-30-11340 | TY 47438-32060-71 |                   |



Part Number - 380030-025

**Spring**

▼ OEM Reference

|            |                 |                   |
|------------|-----------------|-------------------|
| CL 932575  | KO 8763193      | NI 44147-22H00    |
| HY 2037340 | KO 8765283      | TY 47472-21801-71 |
| KM 4920659 | KO 3EB-30-31320 | TY 47472-U2130-71 |
| KM 8763193 | KO 3EC-30-11360 | YT 900955827      |
| KO 4942607 | KO 3EC-30-31320 |                   |
| KO 8761532 | MB 91846-12500  |                   |



Part Number - 380030-100

**Spring Kit (2)**

▼ OEM Reference

|              |
|--------------|
| HY 1334638   |
| HY 1565316   |
| YT 580051335 |
| YT 913589300 |



Part Number - 380030-023

**Spring**

▼ OEM Reference

|                  |                  |                   |
|------------------|------------------|-------------------|
| AC 4941622       | HAM 3EC-30-15750 | MB 91246-03600    |
| CL 932582        | HY 350379        | NI 44024-L0700    |
| HAM 4941622      | KM 4906137       | NI 44026-L0100    |
| HAM 4969577      | KM 4920622       | NI 44083-00H00    |
| HAM 8761530      | KM 4941622       | TY 47636-10110-71 |
| HAM 34B-30-14420 | KO 34B-30-14420  | TY 47636-U1100-71 |



Part Number - 380030-058

**Spring**

▼ OEM Reference

|                |                 |                   |
|----------------|-----------------|-------------------|
| CL 932576      | KO 34B-30-14320 | TC C521123254540  |
| CT 91446-02500 | KO 3EC-30-11330 | TY 47435-32060-71 |
| KM 4941613     | NI 44039-22H00  | TY 47435-U2130-71 |



Part Number - 380030-172

**Spring**

▼ OEM Reference

|                |                 |                   |
|----------------|-----------------|-------------------|
| AC 4974326     | HAM 4974326     | TC 521103625160   |
| CT 97546-01800 | KO 3EA-30-11250 | TY 47511-22500-71 |
| HAM 3EA-11250  | NI 44214-00H00  | TY 47513-U1130-71 |



Part Number - 380030-119

**Spring**

▼ OEM Reference

|                |                   |                   |
|----------------|-------------------|-------------------|
| AC AC4940530   | KO 3EA-30-11150   | TY 47512-U1130-71 |
| CT 97546-01700 | NI 44214-00H00    |                   |
| KM 4940530     | TY 47512-22500-71 |                   |



Part Number - 380023-015  
**Spring**

▼ OEM Reference

|                 |                 |                   |
|-----------------|-----------------|-------------------|
| AC 3EB-30-42160 | KM 8761534      | TC C521121815161  |
| CL 932566       | KO 3BB-30-12160 | TY 47462-32500-71 |
| CT 91446-03200  | KO 3EB-30-42160 | TY 47462-U2130-71 |
| HY 2037332      | NI 44214-22H01  | YT 900955814      |



Part Number - 380023-001-02  
**Brake Pedal Pad**

▼ OEM Reference

|                 |
|-----------------|
| KO 3EB-36-31130 |
|-----------------|



Part Number - 380030-081  
**Spring**

▼ OEM Reference

|                 |
|-----------------|
| KO 3BB-30-12260 |
|-----------------|



Part Number - 380023-008  
**Brake Pedal Pad**

▼ OEM Reference

|            |                   |                   |
|------------|-------------------|-------------------|
| AC 8761606 | HY 3045352        | TY 31319-20540-71 |
| CL 446183  | TY 00591-10808-81 | TY 31319-23000-71 |
| CL 7000977 | TY 00591-35270-81 | YT 220004289      |
| CT 0971315 | TY 00591-53231-81 |                   |



Part Number - 380023-002  
**Plate, Disk Brakes**

▼ OEM Reference

|            |
|------------|
| DW D700251 |
|------------|



Part Number - 380023-004  
**Sheave, Brake**

▼ OEM Reference

|                 |                 |              |
|-----------------|-----------------|--------------|
| HY 1334644      | KO 3EC-30-11180 | YT 919139450 |
| KO 4944644      | MB 91446-03800  |              |
| KO 3BB-30-12180 | NI 44025-22H00  |              |



Part Number - 380023-003  
**Friction Plate, Disk Brakes**

▼ OEM Reference

|            |
|------------|
| DW D141112 |
|------------|



Part Number - 380030-075  
**Emergency Brake Handle**

▼ OEM Reference

|                 |
|-----------------|
| KO 3EB-39-41112 |
|-----------------|



Part Number - 380020-005-02  
**Brake Pad (1)**

▼ OEM Reference

|                  |
|------------------|
| TY 47117-1224071 |
| AC 4943897       |
| CT 97046-21800   |
| TC C51M001507405 |
| KO 3BA-30-31731  |



Part Number - 380023-009  
**Emergency Brake Handle**

▼ OEM Reference

|              |
|--------------|
| HY 1376557   |
| YT 580013352 |



Part Number - 380023-005  
**Accelerator Pedal**

▼ OEM Reference

|              |
|--------------|
| HY 1383672   |
| YT 915356400 |



Part Number - 380023-010  
**Emergency Brake Handle**

▼ OEM Reference

|                   |
|-------------------|
| TY 46102-23470-71 |
| TY 46106-23320-71 |



Part Number - 380023-022  
**Accelerator Pedal**

▼ OEM Reference

|                |
|----------------|
| MB 91351-24800 |
|----------------|



Part Number - 380101-768  
**Emergency Brake Handle**

▼ OEM Reference

|                |
|----------------|
| CT 91351-21500 |
| CT 91352-09200 |
| MB 91351-21500 |
| MB 91352-09200 |



Part Number - 380023-020  
**Emergency Brake Handle**

▼ OEM Reference  
CT 91A51-20010  
MB 91A51-20010  
NI 36010-FK101



Part Number - 380023-014  
**Emergency Brake Cable**

▼ OEM Reference  
HM 3EB-30-31340 KM 8766089 KO 3EB-30-31340  
KM 8761537 KO 3EB-30-11232



Part Number - 380023-017  
**Emergency Brake Cable**

▼ OEM Reference  
KO 3EB-30-51110



Part Number - 380023-018  
**Emergency Brake Cable**

▼ OEM Reference  
KO 3EB-30-51120



Part Number - 380023-011  
**Emergency Brake Cable**

▼ OEM Reference  
CT 91E46-00215  
NI 36530-FK001



Part Number - 380023-012  
**Emergency Brake Cable**

▼ OEM Reference  
CT 91E46-00119  
NI 36531-FK001



Part Number - 380101-601  
**Emergency Brake Cable**

▼ OEM Reference  
CT 14486320 HY 2077120 YT 924306402  
CT A0000-16288 HY 2077246 YT 932864402  
HY 2021620 MB A0000-16288 YT 932866402  
HY 2026768 TY 00591-76876-81 YT 932867402  
HY 2074978 YT 919492402



Part Number - 380023-024  
**Cable - Parking Brake LH**

▼ OEM Reference  
TY 47404-26601-71



Part Number - 380023-028  
**Cable - Parking Brake**

▼ OEM Reference  
TY 46401-10920-71



Part Number - 380023-034  
**Cable Sub-Assy, Parking Brake (RH)**

▼ OEM Reference  
TY 47403-26601-71



Part Number - 380030-311  
**Parking Brake Cable**

▼ OEM Reference  
TY 47503-36640-71



Part Number - 380023-027  
**Parking Brake Cable, Release**

▼ OEM Reference  
HY 1462535  
YT 580011065



Part Number - 380030-003  
**Brake Adjuster Cable**

▼ OEM Reference  
AC 8761533 KM 8761533 NI 44215-22H00  
HAM 4923069 KO 3BB-30-12190 TY 47470-33060-71  
HAM 8761533 MB 91546-02300 TY 47470-U2130-71  
HAM 3BB-30-12190



Part Number - 380030-004  
**Brake Adjuster Cable**

▼ OEM Reference  
AC 4940537 KM 4940537 NI 44215-00H00  
HAM 4940537 KO 3EA-30-11330 TY 47501-11630-71  
HAM 3EA-30-11330 MB 91246-04400 TY 47504-U1130-71



Part Number - 380023-029  
**Spring - Brake Shoe Hold Down**

▼ OEM Reference  
TY 47435-23420-71



Part Number - 380030-266

**Cup Shoe Hold Down**

▼ OEM Reference

|                   |                   |                     |
|-------------------|-------------------|---------------------|
| AC 3ED-30-31240   | HY 3143330        | NI 44043-50H05      |
| AC 34C-30-11561   | HY 66002725       | NI 44043-L1101      |
| AC 3EC-30-11370   | JU 50442744       | NI 44043-L9000      |
| AC 4942608        | KO 34C-30-11561   | NI C-52-51302-53840 |
| AC 4942643        | KO 3EC-30-11370   | TC 44043-50H05      |
| AC 4969579        | KO 3EC-30-15770   | TC 44043-L1101      |
| BK KM3EC-30-11370 | KO 3ED-30-31240   | TC 44043-L9000      |
| CL 448575         | KO 3FA-80-15640   | TC C-52-51302-53840 |
| CT 1033433        | KO 3LA-61-11341   | TY 47443-30410-71   |
| CT 32051-00250    | KO 4942608        | YT 220018411        |
| CT 50442744       | KO 4942643        | YT 220020606        |
| CT 91846-02700    | KO 4969579        | YT 220043330        |
| CT NL110000132    | LI KM3EC-30-11370 | YT 220044330        |
| HN 52-51302-53840 | MB 1033433        | YT 220077636        |
| HY 2037341        | MB 32051-00250    | YT 66002725         |
| HY 3049444        | MB 50442744       | YT 900750841        |
| HY 3121721        | MB 91846-02700    |                     |
| HY 3124657        | MB NL110000132    |                     |



Part Number - 380023-025

**Adjuster, Brake (RH)**

▼ OEM Reference

|                   |                   |                   |
|-------------------|-------------------|-------------------|
| AC 304-32-32200   | HY 1334645        | MB 52-11211-23300 |
| AC 34B-30-14240   | HY 3056759        | MB 52-11211-23301 |
| AC 34B-30-14241   | HY 3132225        | MB 64335-50214    |
| AC 4941610        | JU 14322770       | MB A0000-01934    |
| CL 7001098        | JU 14499700       | TY 00591-06302-81 |
| CT 0A1934         | KO 304-32-32200   | TY 00591-35456-81 |
| CT 12J41-2330     | KO 34B-30-14240   | TY 00591-58148-81 |
| CT 1921-64078     | KO 34B-30-14241   | TY 00591-58198-81 |
| CT 1921-64300     | KO 4941610        | TY 47460-32060-71 |
| CT 217054         | MB 0A1934         | YT 220020229      |
| CT 52-11207-23300 | MB 12J41-2330     | YT 220023825      |
| CT 52-11211-23300 | MB 1921-64078     | YT 220077627      |
| CT 52-11211-23301 | MB 1921-64300     | YT 505963554      |
| CT 64335-50214    | MB 217054         | YT 900488810      |
| CT A0000-01934    | MB 52-11207-23300 |                   |



Part Number - 380023-013

**Brake Shoe Hold Down Kit**

▼ OEM Reference

|              |
|--------------|
| HY 2026114   |
| HY 2026786   |
| YT 926640300 |
| YT 929150300 |



Part Number - 380023-026

**Adjuster, Brake (LH)**

▼ OEM Reference

|                   |                   |                   |
|-------------------|-------------------|-------------------|
| AC 304-32-31200   | HY 1334646        | MB A0000-01935    |
| AC 34B-30-14140   | JU 14156550       | TY 00591-06301-81 |
| AC 34B-30-14141   | JU 14499740       | TY 00591-35433-81 |
| AC 4941607        | KO 304-32-31200   | TY 00591-58149-81 |
| CL 7001079        | KO 34B-30-14140   | TY 47450-32060-71 |
| CT 12J41-1330     | KO 34B-30-14141   | TY 47605-30200-71 |
| CT 1921-64077     | KO 4941607        | TY 47705-30200-71 |
| CT 1921-64299     | MB 12J41-1330     | TY 47751-30200-71 |
| CT 217121         | MB 1921-64077     | TY 47761-30200-71 |
| CT 52-11207-13300 | MB 1921-64299     | TY 47762-30200-71 |
| CT 52-11211-13300 | MB 52-11207-13300 | YT 220019815      |
| CT 52-11211-13301 | MB 52-11211-13300 | YT 220023824      |
| CT 91446-03300    | MB 52-11211-13301 | YT 505963556      |
| CT A0000-01935    | MB 91446-03300    | YT 900488809      |



Part Number - 380105-134

**Spring**

▼ OEM Reference

|                   |                   |
|-------------------|-------------------|
| HY 1367774        | TY 00591-76746-81 |
| HY 3057560        | TY 47635-U1100-71 |
| JU 14102310       | YT 220037560      |
| TY 00591-45157-81 | YT 900094807      |
| TY 00591-45162-81 |                   |



Part Number - 380023-030

**Pin - Brake Shoe Hold Down**

▼ OEM Reference

|                   |
|-------------------|
| TY 47431-22000-71 |
|-------------------|



Part Number - 380105-129

**Spring**

▼ OEM Reference

|                |                   |                   |
|----------------|-------------------|-------------------|
| CT A0000-25047 | MB A0000-25047    | TY 47442-U2100-71 |
| CT A0000-25302 | MB A0000-25302    | YT 220034796      |
| HY 3030147     | TY 47442-22000-71 | YT 66000872       |



Part Number - 380023-016

**Brake Adjuster (LH)**

▼ OEM Reference

|                |                 |                |
|----------------|-----------------|----------------|
| CT 91E46-10115 | KO 3EB-30-51430 | NI 44201-FK000 |
| HY 1600491     | MB 91E46-10115  | YT 580062998   |

## Miscellaneous Brake Parts



Part Number - 380023-006

### Brake Adjuster (LH)

#### ▼ OEM Reference

|                 |                     |                   |
|-----------------|---------------------|-------------------|
| AC 3EC-30-11150 | LP 612-3005         | TY 47460-36610-71 |
| CT 91446-06400  | LP 612-3305         | TY 00591-20843-81 |
| CT 91846-01300  | LP 612-3707         | TY 00591-35462-81 |
| CL 448356       | LP 612-3710         | TY 00591-43843-81 |
| CL 7001103      | LP 612-3719         | TY 00591-58150-81 |
| HY 3115501      | LP 622-1125         | TY 00591-58200-81 |
| HY 3142334      | MB 91446-06400      | TY 47460-21800-71 |
| HY 3143730      | MB 91846-01300      | TY 47460-32500-71 |
| HU 2037327      | NI 44201-22H00      | TY 47460-U2130-71 |
| JU 143574401    | TC 44201-22H00      | YT 220043730      |
| KO 3EC-30-11150 | TC C-52-11239-13300 | YT 900955806      |



Part Number - 380023-019

### Brake Adjuster (LH)

#### ▼ OEM Reference

|                |                 |                |
|----------------|-----------------|----------------|
| CT 91E46-10213 | KO 3EB-30-51450 | NI 44200-FK000 |
| HY 1600492     | MB 91E46-10213  | YT 580062999   |



Part Number - 380023-007

### Brake Adjuster (RH)

#### ▼ OEM Reference

|                 |                     |                   |
|-----------------|---------------------|-------------------|
| AC 3EC-30-11230 | LP 612-3304         | TY 00591-35461-81 |
| CT 91444-06500  | LP 612-3706         | TY 00591-43842-81 |
| CT 91846-01400  | LP 622-1124         | TY 00591-52259-81 |
| CL 7001102      | MB 91444-06500      | TY 00591-58199-81 |
| HY 3038290      | MB 91846-01400      | TY 47450-21800-71 |
| HY 3060453      | NI 44200-22H00      | TY 47450-32500-71 |
| HY 2037328      | TC 44200-22H00      | TY 47450-U2130-71 |
| JU 143574503    | TC C-52-11239-23300 | TY 47450-36610-71 |
| KO 3EC-30-11230 | TN 32299            | YT 220077835      |
| LP 612-3004     | TY 00591-20846-81   | YT 900955807      |



Part Number - 380030-278

### Pedal, Parking Brake

#### ▼ OEM Reference

|                   |
|-------------------|
| TY 46110-26610-71 |
| TY 46110-26612-71 |
| TY 46110-U2230-71 |
| TY 46120-26610-71 |



It's time to make the most of your connections.

- Conduct formal review of data inputs and the value generated to date
- Develop action steps to promote positive change
- Adjust best practices and system settings as needed



This is one of many customized reports that is available through Crown's InfoLink Services.



Part Number - 380021-004-02  
**Brake Cylinder**

▼ OEM Reference

|                |                |                   |
|----------------|----------------|-------------------|
| CT 91484-27100 | RA 1-164-912   |                   |
| CT 91484-27101 | RA 1-164-915   |                   |
| CT 91484-37100 | RA 750         |                   |
| MB 1015776     | RA 990-253     |                   |
| CL 7001049     | MB 91484-17100 | TY 00591-35379-81 |
| CT 1015776     | MB 91484-27100 | TY 00591-58010-81 |
| CT 1015777     | MB 91484-27101 | TY 47530-42100-71 |
| CT 91484-17100 | MB 91484-37100 |                   |



Part Number - 380030-063  
**Master Cylinder**

▼ OEM Reference  
KO 3EB-36-51180



Part Number - 380021-003-02  
**Brake Cylinder**

▼ OEM Reference

|            |                   |                   |
|------------|-------------------|-------------------|
| CL 7001081 | JU 14495460       | TY 00591-58023-81 |
| HY 1347048 | MA M45110         | YT 220037522      |
| HY 3057522 | TY 00591-35435-81 | YT 505963537      |



Part Number - 380030-090  
**Master Cylinder**

▼ OEM Reference  
AT 47530-U2100-71  
TY 47530-13201-71  
TY 47530-13400-71  
TY 47530-U2100-71  
TY 47530-U2100-71A



Part Number - 380021-002-02  
**Brake Cylinder**

▼ OEM Reference

|                |
|----------------|
| CT 91346-40300 |
| CT 93146-02500 |
| CT 93146-12500 |
| MB 93146-02500 |
| MB 93146-12500 |



Part Number - 380030-166  
**Master Cylinder**

▼ OEM Reference  
KM 4949450  
KM 4967822  
KO 3BA-36-21101  
KO 3EB-36-22700



Part Number - 380021-001-02  
**Master Cylinder**

▼ OEM Reference

|                   |
|-------------------|
| AC 8761597        |
| AC 8766117        |
| KO 3EB-36-31280   |
| KO 3EB-36-31281   |
| KO MY022-8098-00  |
| TY 00591-27394-81 |



Part Number - 380030-167  
**Master Cylinder**

▼ OEM Reference  
KM 4940552  
KO 3EA-36-11100



Part Number - 380021-005-01  
**Master Cylinder**

▼ OEM Reference

|                   |
|-------------------|
| LP 605-7053       |
| TY 47210-23321-71 |
| TY 47210-U2170-71 |



Part Number - 380030-091  
**Master Cylinder**

▼ OEM Reference  
NI 46010-04H00  
NI 46010-11H01



Part Number - 380021-006-01  
**Master Cylinder**

▼ OEM Reference

|              |
|--------------|
| HY 2021338   |
| LP 605-7012  |
| YT 915435400 |



Part Number - 380021-007-01  
**Master Cylinder**

▼ OEM Reference  
HY 1536724  
YT 580040436



Part Number - 380021-008-02  
**Master Cylinder**

▼ OEM Reference

|                |
|----------------|
| CT 91A46-10100 |
| MB 91A46-10100 |
| NI 46010-FJ100 |



Part Number - 380050-051  
**Wheel Cylinder**  
Bore size 1 1/2"

▼ OEM Reference

|                |                  |                   |
|----------------|------------------|-------------------|
| CL 932561      | KM 4940945       | TY 47410-21580-71 |
| CT 215467      | KM 4949375       | TY 47410-21800-71 |
| CT 91446-00900 | KO 34B-30-14311  | TY 47410-22500-71 |
| CT 91846-00800 | KO 34B-30-15311  | TY 47410-32500-71 |
| HY 1334648     | KO 3EB-30-11310  | TY 47410-U2130-71 |
| HY 2027398     | NI 44100-22H00   | YT 505963500      |
| KM 4920078     | TC C521124652001 | YT 900488803      |

**Cylinders**



Part Number - 380050-052

**Wheel Cylinder**  
Bore size 1 1/4"

▼ OEM Reference

|    |              |    |             |
|----|--------------|----|-------------|
| CT | 91E46-00112  | NI | 44100-FK000 |
| HY | 1565290      | YT | 580051320   |
| KO | 3EB-30-41440 |    |             |



Part Number - 380050-053

**Wheel Cylinder**  
Bore size 7/8"

▼ OEM Reference

|    |              |    |               |    |                |
|----|--------------|----|---------------|----|----------------|
| AC | 8761142      | KO | 3EA-30-25111  | TY | 47410-10480-71 |
| CT | 91246-01800  | NI | 44100-00H00   | TY | 47410-11630-71 |
| CT | 91B46-00312  | NI | 44100-11H01   | TY | 47410-12000-71 |
| DW | A251738      | NI | 44100-FJ500   | TY | 47430-11630-71 |
| KM | 4941515      | NI | 44100-L1400   |    |                |
| KO | 325-32-21400 | TC | C521102952000 |    |                |



Part Number - 380055-060

**Wheel Cylinder**  
Bore size 1 1/4"

▼ OEM Reference

|    |             |    |              |    |                |
|----|-------------|----|--------------|----|----------------|
| CT | 93446-01300 | KM | 8765304      | TY | 47410-32060-71 |
| KM | 4940951     | KO | 3EC-30-12120 |    |                |
| KM | 4944669     | KO | 3EC-30-39110 |    |                |



Part Number - 380055-063

**Wheel Cylinder**  
Bore size 7/8"

▼ OEM Reference

|    |           |
|----|-----------|
| HY | 2026775   |
| YT | 902194803 |



Part Number - 380055-068

**Wheel Cylinder**  
Bore size 1 1/4"

▼ OEM Reference

|    |             |    |              |    |             |
|----|-------------|----|--------------|----|-------------|
| AC | 8765293     | KM | 8765293      | NI | 44100-53H01 |
| CT | 91946-00600 | KO | 3EC-30-21120 | YT | 580011423   |
| HY | 1463341     | KO | 3EC-30-31110 |    |             |



Part Number - 380106-149

**Wheel Cylinder**  
Bore size 1 1/4"

▼ OEM Reference

|    |                |
|----|----------------|
| TC | 234A3-72001    |
| TY | 47410-23420-71 |



Part Number - 380055-071-01

**Tilt Cylinder**  
5° forward, 8° backward

▼ OEM Reference

|    |           |
|----|-----------|
| HY | 2062424   |
| YT | 580042216 |



Part Number - 380055-072-01

**Tilt Cylinder**

▼ OEM Reference

|    |           |
|----|-----------|
| HY | 2037392   |
| YT | 580005920 |



Part Number - 380055-073-01

**Tilt Cylinder**

▼ OEM Reference

|    |           |
|----|-----------|
| HY | 2071862   |
| YT | 580053487 |



Part Number - 380055-074-01

**Tilt Cylinder**

▼ OEM Reference

|    |           |
|----|-----------|
| HY | 1338742   |
| YT | 518841601 |



Part Number - 380055-075-01

**Tilt Cylinder (LH)**

▼ OEM Reference

|    |         |    |           |
|----|---------|----|-----------|
| HY | 2076686 | YT | 580060620 |
| HY | 2076689 | YT | 580060623 |



Part Number - 380055-076-01

**Tilt Cylinder (RH)**

▼ OEM Reference

|    |         |    |           |
|----|---------|----|-----------|
| HY | 2076676 | YT | 580060616 |
| HY | 2076679 | YT | 580060619 |



Part Number - 380055-080-01

**Power Steering Cylinder**

▼ OEM Reference

|    |             |
|----|-------------|
| NI | 49509-FC30B |
|----|-------------|



Part Number - 380055-081-01

**Side/Shifter Cylinder**

▼ OEM Reference

|    |           |
|----|-----------|
| HY | 1360125   |
| YT | 519666601 |



Part Number - 380055-082-01

**Side/Shifter Cylinder**

▼ OEM Reference

|    |           |
|----|-----------|
| CA | 6020048   |
| HY | 1489016   |
| HY | 2043528   |
| YT | 580020708 |



Part Number - 380050-037

**Packing Cylinder Kit**

▼ OEM Reference

|            |                   |              |
|------------|-------------------|--------------|
| CL 446444  | JU 14462360       | YT 220021100 |
| CT 973546  | TY 00591-22382-81 | YT 516149005 |
| HY 2302265 | TY 00591-32404-81 |              |
| HY 3054917 | TY 00591-60962-81 |              |



Part Number - 380050-038

**Lift Cylinder O/H Kit**

▼ OEM Reference

TY 00591-76586-81  
YT 505136031  
YT 522375008



Part Number - 380055-054

**Lift Cylinder O/H Kit**

▼ OEM Reference

CA 561307  
TY 04654-U2010-71



Part Number - 380050-039

**Lift Cylinder O/H Kit**

▼ OEM Reference

|            |                   |
|------------|-------------------|
| CL 7004445 | TY 00591-45306-81 |
| HY 2307874 | YT 220037756      |
| HY 3057756 | YT 505136027      |



Part Number - 380055-058

**Lift Cylinder O/H Kit**

▼ OEM Reference

CA 560349



Part Number - 380055-059

**Lift Cylinder O/H Kit**

▼ OEM Reference

CA 562591



Part Number - 380055-061

**Lift Cylinder O/H Kit**

▼ OEM Reference

TY 04652-U2020-71



Part Number - 380055-077

**Lift Cylinder O/H Kit**

▼ OEM Reference

NI 58099-FA400



Part Number - 380055-083

**Lift Cylinder O/H Kit**

▼ OEM Reference

NI 58099-FA500



Part Number - 380055-084

**Lift Cylinder O/H Kit**

▼ OEM Reference

NI 58099-FA31B



Part Number - 380030-211

**Lift Cylinder O/H Kit**

▼ OEM Reference

CL 1813062



Part Number - 380103-060

**Lift Cylinder O/H Kit**

▼ OEM Reference

HY 1355497  
YT 505136041



Part Number - 380103-205

**Lift Cylinder O/H Kit**

▼ OEM Reference

MB 93051-10068



Part Number - 380055-085

**Lift Cylinder O/H Kit**

▼ OEM Reference

CT 93051-10078  
MB 93051-10078



Part Number - 380103-052

**Lift Cylinder O/H Kit**

▼ OEM Reference

TY 04654-U1010-71



Part Number - 380055-070

**Tilt Cylinder O/H Kit**

▼ OEM Reference

HY 1494726  
YT 580023428



Part Number - 380055-056

**Seal Kit - Tilt Cylinder**

▼ OEM Reference

HY 1493306



## Cylinder Parts



Part Number - 380050-041

### Tilt Cylinder O/H Kit

#### ▼ OEM Reference

|                   |                   |
|-------------------|-------------------|
| HY 2302714        | TY 00591-60963-81 |
| HY 3054918        | TY 00591-76642-81 |
| JU 1444116        | YT 220021877      |
| JU 14441160       | YT 506149006      |
| TY 00591-32407-81 | YT 516149006      |



Part Number - 380050-050

### Tilt Cylinder O/H Kit

#### ▼ OEM Reference

KO 3EB-64-05190  
KM 4948516



Part Number - 380055-064

### Tilt Cylinder O/H Kit

#### ▼ OEM Reference

HY 1492644  
YT 5800224-11



Part Number - 380055-065

### Tilt Cylinder O/H Kit

#### ▼ OEM Reference

CL 1811697



Part Number - 380055-066

### Tilt Cylinder O/H Kit

#### ▼ OEM Reference

HAM 3EB-64-A5191  
KO 3EB-64-A5191



Part Number - 380055-067

### Tilt Cylinder O/H Kit

#### ▼ OEM Reference

TY 04655-U2010-71



Part Number - 380055-069

### Tilt Cylinder O/H Kit

#### ▼ OEM Reference

HY 1494719  
YT 580023425



Part Number - 380055-088

### Seal Kit - Steering Cylinder

#### ▼ OEM Reference

YT 580060036



Part Number - 380104-392

### Power Steering O/H Kit

#### ▼ OEM Reference

|                |                   |
|----------------|-------------------|
| CT 14485550    | MB 14485550       |
| CT A0000-07950 | MB A0000-07950    |
| HY 1367172     | TY 00591-74599-81 |
| HY 2026822     | YT 901905851      |
| JU 14485550    | YT 901905852      |



Part Number - 380055-055

### Power Steering O/H Kit

#### ▼ OEM Reference

KM 4949737  
KO 3EB-64-A2000



Part Number - 380055-062

### Power Steering O/H Kit

#### ▼ OEM Reference

TY 04433-20110-71



Part Number - 380055-078

### Power Steering O/H Kit

#### ▼ OEM Reference

NI 49599-FC000



Part Number - 380055-079

### Power Steering O/H Kit

#### ▼ OEM Reference

NI 49599-FC00B



Part Number - 380104-344

### Power Steering O/H Kit

#### ▼ OEM Reference

TY 04433-U2050-71



Part Number - 380030-038

### Power Steering O/H Kit

#### ▼ OEM Reference

KO ON43001-06565



Part Number - 380104-362

### Power Steering O/H Kit

#### ▼ OEM Reference

HY 1501412  
YT 580026957



Part Number - 380055-057

### Seal Kit - Hydraulic Cylinder

#### ▼ OEM Reference

HY 2028626

## Tune-Up Kits and Planned Maintenance Kits

for IC forklifts offer a convenient, time-saving solution for completing important routine maintenance. Kits help by combining all of the necessary components under a single part number and are available for IC forklifts and engine types from a wide variety of manufacturers.

### Tune-Up Kits

Include the distributor cap, rotor, ignition wire set, and spark plugs for the engine type and manufacturer indicated.



| Make        | Models  | Engine Mfg.     | Engine    | Part Number   |
|-------------|---|-----------------|-----------|---------------|
| Caterpillar | GC25K   | Mitsubishi      | 4G63-4G64 | 380012-019-03 |
| Daewoo      | GC20E-3   | Mitsubishi      | G424      | 380012-019-04 |
| Hyster      | H50XM   | Mazda 2.0L      | FE        | 380012-019-02 |
| Hyster      | S50XM   | Mazda 2.0L/2.2L | FE/F2     | 380012-019-02 |
| Hyster      | H50XM   | General Motors  | GM 3.0L   | 380012-019-05 |
| Hyster      | S50XM   | General Motors  | GM 3.0L   | 380012-019-05 |
| Hyster      | S50FT   | Mazda 2.0L/2.2L | FE/F2     | 380012-019-06 |
| Komatsu     | FG25ST-12   | Nissan          | H20-II    | 380012-019-01 |
| Mitsubishi  | FGC25   | Mitsubishi      | 4G52      | 380012-019-07 |
| Toyota      | 7FGU15, 7FGU20,<br>7FGU25, 7FGU30,<br>8FGU15, 8FGU20,<br>8FGU25, 8FGU30 | Toyota          | 4Y        | 380012-019    |
| Yale        | GLC050VX  | Mazda 2.0L/2.2L | FE/F2     | 380012-019-06 |



### Planned Maintenance Kits

Include high-quality replacement air and oil filters and the recommended amount of 10W/30 motor oil for the engine type and manufacturer indicated.



| Make        | Models  | Engine Mfg.     | Engine    | Part Number   |
|-------------|---|-----------------|-----------|---------------|
| Caterpillar | GC25K   | Mitsubishi      | 4G63-4G64 | 380012-020-09 |
| Daewoo      | GC20E-3   | Mitsubishi      | G424      | 380012-020-08 |
| Hyster      | H50XM   | Mazda 2.0L      | FE        | 380012-020-04 |
| Hyster      | S50XM   | Mazda 2.0L/2.2L | FE/F2     | 380012-020-05 |
| Hyster      | H50XM   | General Motors  | GM 3.0L   | 380012-020-03 |
| Hyster      | S50XM   | General Motors  | GM 3.0L   | 380012-020-07 |
| Hyster      | S50FT   | Mazda 2.0L/2.2L | FE/F2     | 380012-020-10 |
| Komatsu     | FG25ST-12   | Nissan          | H20-II    | 380012-020-01 |
| Mitsubishi  | FGC25   | Mitsubishi      | 4G52      | 380012-020-02 |
| Toyota      | 7FGU15, 7FGU20,<br>7FGU25, 7FGU30,<br>8FGU15, 8FGU20,<br>8FGU25, 8FGU30 | Toyota          | 4Y        | 380012-020-06 |
| Yale        | GLC050VX  | Mazda 2.0L/2.2L | FE/F2     | 380012-020-10 |



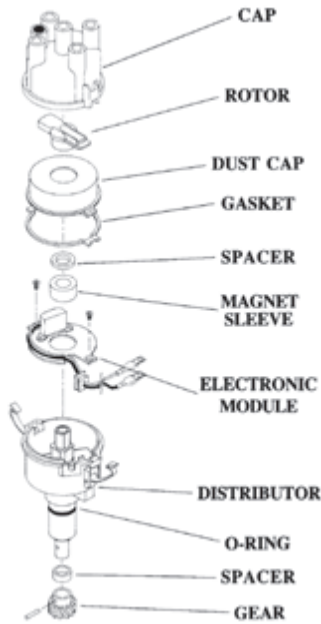

Part Number - 380012-002-02

**Distributor - H20II**

▼ OEM Reference

|                |                   |
|----------------|-------------------|
| AC 8762077     | NI 22100-55K10    |
| AC 8762122     | TC N-22100-50K10  |
| DW D490742     | TY 00591-27353-81 |
| KO 20-203      | TY 00591-42798-81 |
| KO 22100-50K10 |                   |
| KO 22100-50K15 |                   |
| KO 22100-55K10 |                   |
| NI 22100-50K10 |                   |
| NI 22100-50K15 |                   |



Part Number - 380012-001-02

**Distributor Cap - H20II**

▼ OEM Reference

|                |                   |
|----------------|-------------------|
| AC 8762078     | TC 22162-55K10    |
| DW D490743     | TC 22162-55K11    |
| KO 22162-55K10 | TY 00591-23165-81 |
| KO 25-011      |                   |
| NI 22162-55K10 |                   |



Part Number - 380015-001-02

**Rotor - H20II, 4G63-4G64**

▼ OEM Reference

|                |                |                   |
|----------------|----------------|-------------------|
| AC 8762079     | DW A218357     | MB MM611850       |
| BR CK923627    | DW D490744     | MB T880T-18972    |
| CL 4335223     | HN MD618262    | NI 22157-55K10    |
| CL 923627      | HY 3142510     | NI 22157-55K15    |
| CT 91H20-04710 | KO 22157-55K10 | NI CK923627       |
| CT 9I4658      | KO 26-011      | RN J5-5610        |
| CT MD611817    | MB 91H20-04710 | RN J5-5611        |
| CT MD618262    | MB 9I4658      | TC N-22157-55K10  |
| CT MM611850    | MB MD611817    | TY 00591-23164-81 |
| CT T880T-18972 | MB MD618262    | YT 220025671      |



Part Number - 380012-003-02

**Distributor - 4Y**

▼ OEM Reference

|                   |                   |
|-------------------|-------------------|
| CT A0000-14798    | TY 19030-78151-71 |
| ND 290000621      | TY 19030-78154-71 |
| TC 212T1-06101    | TY 19030-96150    |
| TY 19030-78150-71 |                   |



Part Number - 380012-004-02

**Distributor Cap - 4Y**

▼ OEM Reference

|                   |                   |
|-------------------|-------------------|
| CL 7000255        | TY 00591-53200-81 |
| CT 2I5154         | TY 19101-71010-71 |
| HY 3048471        | TY 19101-76007-71 |
| TC 212T1-06111    | TY 19101-76013-71 |
| TY 00591-10752-81 | YT 220004547      |
| TY 00591-32688-81 |                   |



Part Number - 380015-002-02

**Rotor - 4Y**

▼ OEM Reference

|                |                   |                   |
|----------------|-------------------|-------------------|
| CL 446130      | TY 00591-10757-81 | TY 19102-73020    |
| CT 2I5133      | TY 00591-63393-81 | TY 19102-73021    |
| HY 3046813     | TY 19102-16020    | TY 19102-73180    |
| HY 3133089     | TY 19102-16040    | TY 19102-76007-71 |
| HY 3143266     | TY 19102-33010-71 | TY 19102-76009-71 |
| RN J5-5613     | TY 19102-63010-71 | TY 19102-76013-71 |
| TC 212T1-06121 |                   |                   |



Part Number - 380014-006-02

**Ignition Wire Set - H20II**

▼ OEM Reference

|                |                |                   |
|----------------|----------------|-------------------|
| DW D490816     | NI 22450-50K25 | TC 20801-0K042    |
| KO 22450-50K25 | NI 22450-50K50 | TC N-22450-50K50  |
| KO 22450-50K50 | NI 22450-50KA0 | TY 00591-33605-81 |
| KO 22450-50KA0 | TC 20801-0K041 | TY 00591-56038-81 |



Part Number - 380012-013-02

**Distributor Cap - Hercules**  
Style - DC-27

▼ OEM Reference

|            |            |
|------------|------------|
| CL 443487  | KM 4911926 |
| DW D700696 | MB 7N7542  |



Part Number - 380014-001-02

**Ignition Wire Set - 4Y**

▼ OEM Reference

|                   |                   |
|-------------------|-------------------|
| TC 20801-0K052    | TY 80919-76106-71 |
| TC 212T1-08551    | TY 90919-22132    |
| TY 80919-76102-71 |                   |



Part Number - 380012-005-02

**Distributor - H20**

▼ OEM Reference

|                |                   |
|----------------|-------------------|
| AC 4942371*    | NI 22100-71317    |
| CL 445285      | NI 22100-74011    |
| CL 7000308     | NI 22100-K7201    |
| CT 0971564     | TC N-22100-49207  |
| HY 3123249     | TC N-22100-71306  |
| KO 20-200      | TC N-22100-71317  |
| KO 22100-K7201 | TC N-22100-K7201  |
| NI 22100-49206 | TY 00591-07207-81 |
| NI 22100-49207 | TY 00591-32718-81 |
| NI 22100-49210 | TY 00591-51220-81 |
| NI 22100-71305 | YT 220024204      |
| NI 22100-71306 | YT 220025194      |
| NI 22100-71315 |                   |

\*Old style with points & rotor system, new electronic style is PN 380101-496



Part Number - 380012-011-02

**Distributor Cap - 4G32-52-54, H20, A15**

▼ OEM Reference

|                |                |                   |
|----------------|----------------|-------------------|
| AC 4920234     | KO 22162-R9006 | SG MD611686       |
| AC 4921224     | KO 22162-R9007 | TC N-22162-25G10  |
| AC 4949023     | MB 1017046     | TC N-22162-25G11  |
| CL 3779914     | MB MD602756    | TC N-22162-R9006  |
| CL 7000312     | MB MD602949    | TC N-22162-R9007  |
| CL 909351      | MB MD607597    | TY 00591-03628-81 |
| CL 916005      | MB MD611686    | TY 00591-31074-81 |
| CT 0971276     | MB T232T-46772 | TY 00591-32686-81 |
| CT 0971771     | NI 22162-11E07 | TY 00591-33765-81 |
| CT 1017046     | NI 22162-17M01 | TY 00591-33766-81 |
| CT 971276      | NI 22162-17M03 | TY 00591-51412-81 |
| CT 971771      | NI 22162-25G10 | TY 00591-51418-81 |
| CT MD602756    | NI 22162-25G11 | TY 00591-51420-81 |
| CT MD602949    | NI 22162-A3514 | TY 00591-56301-81 |
| CT MD607597    | NI 22162-R9006 | YT 220000727      |
| CT MD611686    | NI 22162-R9007 | YT 220012921      |
| CT T232T-46772 | NI 2216217M01  | YT 220016273      |
| HY 3000542     | NI 2216217M03  | YT 220054038      |
| HY 3020828     | NI CK3779914   | YT 220054193      |
| HY 3021276     | NI MD611686    | YT 901284807      |
| HY 3043274     | SG 3779914     | YT 901304806      |
| KO 22162-25G11 | SG MD611685    |                   |



Part Number - 380012-012-02

**Distributor Cap - H20**

▼ OEM Reference

|                |                   |
|----------------|-------------------|
| KO 22162-78A10 | NI 22162-78A00    |
| KO 25-003      | NI 22162-78A10    |
| MB T46371      | TC N-22162-G5710  |
| MB 216276      | TC N-22162-G5711  |
| NI 22162-G5710 | TC N-22162-23G15  |
| NI 22162-G5711 | TC N-22162-78A10  |
| NI 22162-17M02 | TY 00591-07216-81 |
| NI 22162-17M04 | TY 00591-32687-81 |
| NI 22162-23G15 | TY 00591-51417-81 |
| NI 22162-40F00 | YT 220012748      |
| NI 22162-40F10 | YT 220024209      |
| NI 22162-75A10 | YT 220070292      |
| NI 22162-78AX0 |                   |
| AC 4969894     |                   |
| CL 445294      |                   |
| CL 7000253     |                   |
| CL 872631      |                   |
| CT 46371       |                   |
| CT 216276      |                   |
| HY 3046816     |                   |
| HY 3132609     |                   |
| KO 22162-G5710 |                   |
| KO 22162-G5711 |                   |
| KO 22162-23G15 |                   |



Part Number - 380015-008-02

**Rotor - H20, J15**

▼ OEM Reference

|                 |
|-----------------|
| AC 4942380      |
| KO 22157-05M02  |
| KO 37Z-02-HR901 |



Part Number - 380015-007-02

**Rotor - 4G32-52-54, J15, H20, A15, 4G33**

▼ OEM Reference

|             |                |                |
|-------------|----------------|----------------|
| AC 4920235  | CT MD611850    | NI 22157-R9007 |
| BR CK909353 | KO 22157-R9007 | NI CK909353    |
| BR CK916006 | MB 1017001     | NI CK916006    |
| CL 909353   | MB 1041551     |                |
| CL 916006   | MB MD602758    |                |
| CT MD602758 | MB MD611850    |                |



Part Number - 380014-008-02

**Ignition Wire Set - H20**

▼ OEM Reference

|               |                   |                   |
|---------------|-------------------|-------------------|
| AC 4942394    | NI 22450-49251    | TY 00591-01133-81 |
| CL 1810436    | NI 22450-L0150B   | TY 00591-06286-81 |
| HY 0214998    | NI 22450-L1051    | TY 00591-32723-81 |
| HY 3052065    | NI 22450-L1125    | TY 00591-56004-81 |
| KO HE-2500753 | TC 22450-L1051    |                   |
| KO HE-2500754 | TY 00591-00152-81 |                   |



Part Number - 380051-001

**Ignition Wire Set - 4G52 & 4G54**

▼ OEM Reference

|            |
|------------|
| CL 909376  |
| CL 1811616 |
| CL 1811917 |
| CL 3779999 |
| KM 4920321 |



Part Number - 380012-009-02  
**Distributor - 4G63-4G64**

- ▼ OEM Reference
- |             |                   |
|-------------|-------------------|
| CL 918313   | MB MD169418       |
| CT 1041457  | MB T3T65675       |
| CT MD169418 | NI MD169418       |
| MB 1041457  | TY 00591-42783-81 |



Part Number - 380012-007-02  
**Distributor Cap - 4G63-4G64**

- ▼ OEM Reference
- |                |                   |
|----------------|-------------------|
| CL 4335221     | MB MD618364       |
| CL 923626      | MB T232T-48372    |
| CT MD618364    | NI CK923626       |
| CT T232T-48372 | NI MD618364       |
| DW A218353     | NP EP-335         |
| HN MD618364    | SG MD618364       |
| HY 1554033     | TY 00591-75236-81 |
| HY 3127916     | YT 220022013      |
| HY 3143902     | YT 220043902      |
|                | YT 580047018      |



Part Number - 380015-001-02  
**Rotor - H20II, 4G63-4G64**

- ▼ OEM Reference
- |                |                |                   |
|----------------|----------------|-------------------|
| AC 8762079     | DW A218357     | MB MM611850       |
| BR CK923627    | DW D490744     | MB T880T-18972    |
| CL 4335223     | HN MD618262    | NI 22157-55K10    |
| CL 923627      | HY 3142510     | NI 22157-55K15    |
| CT 91H20-04710 | KO 22157-55K10 | NI CK923627       |
| CT 914658      | KO 26-011      | RN J5-5610        |
| CT MD611817    | MB 91H20-04710 | RN J5-5611        |
| CT MD618262    | MB 914658      | TC N-22157-55K10  |
| CT MM611850    | MB MD611817    | TY 00591-23164-81 |
| CT T880T-18972 | MB MD618262    | YT 220025671      |



Part Number - 380014-002-02  
**Ignition Wire Set - 4G63-4G64**

- ▼ OEM Reference
- |           |             |            |
|-----------|-------------|------------|
| CL 920989 | CT MD972033 | DW A218378 |
| CL 920990 | CT MD972748 | MB 1085017 |



Part Number - 380015-005-02  
**Rotor - FE-FE2**

- ▼ OEM Reference
- |              |
|--------------|
| HY 1554034   |
| YT 580047019 |



Part Number - 380012-008-02  
**Distributor Cap - D5**

- ▼ OEM Reference
- |            |                   |
|------------|-------------------|
| HY 1371206 | TY 00591-11106-81 |
| HY 3020958 | YT 901356802      |
| NP FA-164  |                   |



Part Number - 380012-006-02  
**Distributor Cap - F2-FE**

- ▼ OEM Reference
- |                   |                   |
|-------------------|-------------------|
| HY 1326394        | TY 00591-33666-81 |
| HY 1339151        | TY 00591-56299-81 |
| HY 1370740        | TY 00591-56303-81 |
| HY 3054982        | YT 150022511      |
| JU 14415530       | YT 220020015      |
| JU 14491840       | YT 505960556      |
| JU 14501360       | YT 505960583      |
| MB T45327         | YT 901357802      |
| TC T-FEEN-18-V00  | YT 901580802      |
| TY 00591-06004-81 | YT 901580812      |
| TY 00591-31680-81 |                   |



Part Number - 380015-004-02  
**Rotor - F2-FE**

- ▼ OEM Reference
- |                |                   |                   |
|----------------|-------------------|-------------------|
| CL 444460      | NP EP-780         | TY 00591-33710-81 |
| CL 446399      | RN J5-5614        | TY 00591-56318-81 |
| CT 218115      | RN J5-5615        | TY 00591-56319-81 |
| HY 1326395     | TC T-F829-18-V05  | TY 00591-56321-81 |
| HY 1362035     | TC T-FE2S-18-V05  | YT 150022510      |
| HY 1367561     | TY 00591-06005-81 | YT 220070293      |
| HY 2022460     | TY 00591-11046-81 | YT 505960565      |
| HY 2023725     | TY 00591-31681-81 | YT 901356803      |
| MZ F829-18-V05 | TY 00591-31813-81 | YT 901356814      |
| MZ FE2S-18-V05 | TY 00591-33617-81 | YT 901357803      |
| NP EP-339      | TY 00591-33686-81 | YT 901953805      |



Part Number - 380014-005-02  
**Ignition Wire Set - F2-FE**

- ▼ OEM Reference
- |             |                   |                |
|-------------|-------------------|----------------|
| CL 7000201  | TY 00591-11105-81 | YM YA901303803 |
| CL 7000218  | TY 00591-33553-81 | YT 220100562   |
| HY 1362113  | TY 00591-33593-81 | YT 505976593   |
| HY 1369893  | TY 00591-56029-81 | YT 901283805   |
| JU 14364620 | TY 00591-61181-81 | YT 901303803   |
| JU 14495050 | TY 00591-76611-81 |                |



Part Number - 380014-011-02  
**Ignition Wire Set - FE**

- ▼ OEM Reference
- |              |
|--------------|
| HY 1652460   |
| YT 580078981 |



Part Number - 380012-014-02  
**Distributor - H25**

- ▼ OEM Reference
- |                 |                 |                  |
|-----------------|-----------------|------------------|
| AC 78762077     | KO 22100-60K11  | NI 22100-60K11   |
| AC 22100-60K15  | KO 22100-60K15  | NI 22100-60K15   |
| AC 22100-60K15A | KO 22100-60K15A | TC N-22100-60K10 |
| KO 22100-60K10  | NI 22100-60K10  | TC N-22100-60K15 |



Part Number - 380012-015-02

**Distributor Cap - GM 4.3L**

▼ OEM Reference

CT 93720-09911 TY 19101-U3330-71  
HY 1566458 YT 580051808



Part Number - 380015-009-02

**Rotor - GM 6 cyl, GM 4 cyl, GM 3.0L, GM 4.3L**

▼ OEM Reference

HY 1334403



Part Number - 380014-007-02

**Ignition Wire Set - GM 3.0L**

▼ OEM Reference

DOS A218755 HY 1329534 TY 19335-U2120-71  
DW A218755 HY 1337666



Part Number - 380014-012-02

**Ignition Wire Set - GM 4.3L**

▼ OEM Reference

HY 2088997 YT 580072615  
TY 19140-U3330-71



Part Number - 380014-013-02

**Ignition Wire Set - GM 6 cyl**

▼ OEM Reference

CL 923580  
CL 2822859  
CT 91921-08300  
TY 19035-U3160-71  
TY 19110-U3330-71



Part Number - 380012-016-02

**Distributor Cap - Nissan TB45**

▼ OEM Reference

AC 8775050  
KO 8775050  
KO 22162-VB011  
NI 22162-VB011



Part Number - 380012-017-01

**Distributor Cap**

▼ OEM Reference

CL 922229 TY 19101-U3160-71  
CT 90420-01560 YT 580000314  
DW A232132 YT 900005261  
HY 1342528



Part Number - 380012-018-01

**Distributor Cap**

▼ OEM Reference

CL 925036 TY 19101-U2120-71  
DW A218736 YT 580000643  
HY 1334400



Part Number - 380014-009-02

**Ignition Wire Set**

▼ OEM Reference

DW A413624  
HY 2089846  
YT 580073382



Part Number - 380014-014

**Cable - Spark Plug**

▼ OEM Reference

CT MD192991  
MB MD192991



Part Number - 380014-015

**Cable - Spark Plug**

▼ OEM Reference

CT MD192992  
MB MD192992



Part Number - 380014-016

**Cable - Spark Plug**

▼ OEM Reference

CT MD192993  
MB MD192993



Part Number - 380014-017

**Cable - Spark Plug**

▼ OEM Reference

CT MD192994  
MB MD192994



Part Number - 380102-570

**Ignition Wire Set TB45**

▼ OEM Reference

|                 |                |                   |
|-----------------|----------------|-------------------|
| AC 22450-52H25  | HY 3144732     | KO 8771452        |
| AC 22450-52K25  | KO 22450-52H25 | KO B2450-52H25    |
| AC 22451-03J11A | KO 22450-52K25 | LI 2245103J11     |
| AC 22451-37J15  | KO 22451-03J11 | MB A0000-25642    |
| AC 4968842      | KO 22451-37J15 | NI 22450-52H25    |
| AC 4968845      | KO 4968842     | NI 22451-03J11    |
| AC 4974416      | KO 4968843     | NI 22451-37J15    |
| AC 8760967      | KO 4968845     | NI B2450-52H25    |
| AC 8765906      | KO 4968846     | TC 22451-03J11    |
| AC 8765907      | KO 4974416     | TC 22451-37J15    |
| AC 8765909      | KO 8760967     | TC B2450-52H25    |
| AC 8765910      | KO 8765906     | TY 00591-75718-81 |
| AC 8769404      | KO 8765907     | YT 220042739      |
| AC 8771452      | KO 8765909     | YT 220044732      |
| CT A0000-25642  | KO 8765910     |                   |
| HY 3142739      | KO 8769404     |                   |

**Distributors/Caps, Rotors, Spark Plug Wires**



Part Number - 380015-006-02  
**Rotor - TB42 6 cyl, 6G72**

▼ OEM Reference

|               |                |                   |
|---------------|----------------|-------------------|
| AC 4968831    | HY 3122011     | RN J5-5612        |
| CL 2572769    | KO 22157-52H20 | TC N-22157-52H20  |
| CL 444901     | MB 1038060     | TY 00591-20723-81 |
| CT 1038060    | MB MM502535    | YT 220018323      |
| CT MM502535   | MB T880X17571  |                   |
| CT T880X17571 | NI 22157-52H20 |                   |



Part Number - 380015-012-01  
**Rotor - GM 4.3L**

▼ OEM Reference  
 TY 19102-U3330-71



Part Number - 380015-013-02  
**Rotor**

▼ OEM Reference

|                |                   |                   |
|----------------|-------------------|-------------------|
| CL 922221      | HY 1342529        | TY 19102-31720-71 |
| CL 1342529     | HY 1374329        | TY 19102-U3160-71 |
| CL 2575926     | MB 90420-01480    | YT 580000384      |
| CL 922220      | NI NF90420-01480  | YT 900005266      |
| CT 90420-01480 | TY 00591-33685-81 |                   |
| DW A232133     | TY 00591-56322-81 |                   |



Part Number - 380015-011-01  
**Rotor - TB42 & TB45**

▼ OEM Reference

|                |                |
|----------------|----------------|
| AC 8775051     | KO 8775051     |
| KO 22157-VB011 | NI 22157-VB011 |



**NEW!**

Part Number - 370704  
**Spark Plug Tube**

▼ OEM Reference

|                      |                      |                   |
|----------------------|----------------------|-------------------|
| AC 8760345           | HY 3035420           | MB A0000-27564    |
| AC TJ-11191-22010    | KO 8760345           | TY 11191-22010-71 |
| AC TJ-11191-76001-71 | KO TJ-11191-22010    | TY 11191-76001-71 |
| CT A0000-27564       | KO TJ-11191-76001-71 |                   |



Part Number - 380015-010-02  
**Rotor - Peugeot**

▼ OEM Reference

|            |                 |           |
|------------|-----------------|-----------|
| CL 7000271 | KM 4911933      | MB 2W2257 |
| DW D700682 | KO HE40-2504609 |           |

**Coils**



Part Number - 380016-001-02  
**Coil**

▼ OEM Reference

|             |                   |
|-------------|-------------------|
| CL 925969   | MB MD358504       |
| CL 4335230  | MB 1832A002       |
| CT MD358504 | MB MD326638       |
| CT 1832A002 | TY 00591-27426-81 |
| CT MD326638 |                   |
| DW A218371  |                   |



Part Number - 380102-506  
**Ignition Coil**

▼ OEM Reference  
 HY 1584523  
 YT 5800057203



Part Number - 380016-002-02  
**Ignition Coil**

▼ OEM Reference

|                |                 |                |
|----------------|-----------------|----------------|
| CT 91H20-02930 | HAM 22448-AR215 | NI 22448-AR215 |
| HAM 8772266    | NI 22433-AR215  |                |



Part Number - 380016-004-02  
**Ignition Coil**

▼ OEM Reference  
 CL 1242352  
 MB 93721-02600  
 TY 19080-U3330-71



Part Number - 380016-003-02  
**Ignition Coil**

▼ OEM Reference  
 HY 1652458  
 YT 580078979

**FIVE RING DESIGN** - The five rib design prevents flashover and reduces voltage loss. It offers 20% more insulation than conventional plugs. This improved performance is especially significant in plugs with a large gap operating under high voltage.

**INSULATOR** - The insulators are made of a highly purified alumina powder, which gives strength and thermal conductivity at high temperatures, as well as greater physical strength.

**SPECIAL COPPER-GLASS SEAL** - A special mixture of copper and glass powder bonds the center electrode and insulator together for a gas-tight seal. Proper heat is maintained and hot combustion gases are excluded.

**U-GROOVED GROUND ELECTRODE** - This U-Groove allows the spark to fill the gap formed by the U. The ball of fire develops, a larger and hotter flash front, so that the combustion is more complete.

**COPPER CORED CENTER ELECTRODE** - A special center electrode incorporates copper into the core of the nickel chrome binary alloy. This gives superior thermal conductivity, and increases the operating range.

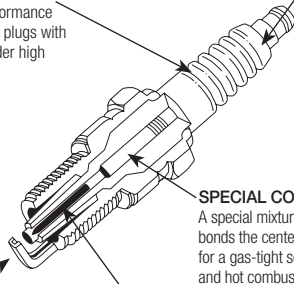

**Part Number - 380013-010-02**

**Spark Plug - W16EXR-U**

▼ OEM Reference

AC 4516333  
ND W16EXR-U

**Part Number - 380013-006-02**

**Spark Plug - W16EX-U**

▼ OEM Reference

|             |                |                |
|-------------|----------------|----------------|
| AC 4920323  | MB MS851101    | PL C44NS       |
| CL 909378   | PL 4253        | PL MS851243    |
| CT 2W9486   | PL 44NS        | PL N11YC       |
| CT MS851101 | PL B2401-89904 | PL N12YC       |
| MB 1038083  | PL BP5EA-L     | PL W16EX-U     |
| MB MS851022 | PL BP5EY       | TY 90919-01954 |

**Part Number - 380013-007-02**

**Spark Plug - W9EP**

▼ OEM Reference

|                      |                   |                   |
|----------------------|-------------------|-------------------|
| AC 8762050           | PL 14G82          | TY 80919-76009-71 |
| BH W10DC             | SL 144483         | TY 80919-76011-71 |
| CL 444771            | TC 20801-0A041    | TY 80999-76018-71 |
| CT 0971353           | TC N-22401-W8914  | TY 90098-09125    |
| HY 0326827           | TC W9EP           | TY 90098-20395    |
| HY 3002288           | TY 00591-06208-81 | TY 90919-01021    |
| HY 326827            | TY 00591-06209-81 | TY 90919-01055-71 |
| KO 22401-W8914       | TY 00591-32695-81 | TY 90919-01950-71 |
| KO 37Z-02-SP02E      | TY 00591-33649-81 | TY 90999-09001-71 |
| KO TJ-90098-09125    | TY 00591-50973-81 | TY 90999-09002-71 |
| KO TJ-90919-01055    | TY 00591-50976-81 | YT 150038500      |
| KO TJ-90919-01950-71 | TY 80098-76006-71 | YT 220001599      |
| ND W9EP              | TY 80919-76004-71 | YT 900537827      |
| NI 22401-W8914       | TY 80919-76005-71 |                   |
| PL 14G22             | TY 80919-76008-71 |                   |

**Part Number - 380013-001-02**

**Spark Plug - W20ES-U**

▼ OEM Reference

|                  |          |            |
|------------------|----------|------------|
| AC 4905798       | PL 43N   | PL B6ES-11 |
| KO 22401-58001   | PL 43XL  | PL C43N    |
| KO 22401-M7714   | PL 44N   | PL C44N    |
| KO 22401-M7716   | PL 44XL  | PL N288    |
| KO 37Z-02-SP04A  | PL AG3   | PL N5C     |
| KO 37Z-02-SP05A  | PL AG30C | PL S43XL   |
| NI N-22401-M7716 | PL AG3CX | PL S44XL   |
| PL 394           | PL AG3X  | PL W16ES-U |
| PL 4056          | PL B6ES  |            |

**Part Number - 380013-002-02**

**Spark Plug - Q14R-U11**

▼ OEM Reference

|                |             |             |
|----------------|-------------|-------------|
| CT 91H20-02860 | PL BCP4ES11 | PL DCP4ES11 |
| KO 22401-FU412 | PL BCP4EY11 | PL DCP4EY11 |
| PL BCP4ES      | PL DCP4E7   | PL FR9DCX   |
| PL BCP4ES11    | PL DCP4ES   |             |

**Part Number - 380013-004-02**

**Spark Plug - W14EXR-U**

▼ OEM Reference

|                    |                |                   |
|--------------------|----------------|-------------------|
| AC 4516353         | CT 1017268     | NI 22401-L1600    |
| AC 4933394         | HY 3002290     | NI 22401-V1414    |
| CL 2385639         | HY 3002347     | TC N-22401-L1600  |
| CL 4338827         | KO 22401-V1414 | TY 00591-02042-81 |
| CL 913639          | MB 1017268     | TY 00591-33646-81 |
| CN SP200S00009RNYC | MB MB1017268   | YT 150112466      |

**Part Number - 380013-005-02**

**Spark Plug - W9EXR-U**

▼ OEM Reference

|            |                   |               |
|------------|-------------------|---------------|
| HY 1361837 | PL BPR2ES         | YT 5059605-35 |
| PL BPR2E   | TY 90919-01954-71 |               |

**Part Number - 380013-008-02**

**Spark Plug - T16PR-U**

▼ OEM Reference

|            |                   |                   |
|------------|-------------------|-------------------|
| BH HR8BC   | HY 0388361        | TY 00591-32692-81 |
| BH HR8BP   | HY 1332675        | TY 00591-42808-81 |
| BH HR9BC   | HY 1332676        | TY 00591-50978-81 |
| CL 446323  | HY 1451269        | TY 90098-16785    |
| CL 925049  | HY 1467579        | YT 150112453      |
| CT 216460  | ND T16PRU         | YT 516484800      |
| DR R-45-TS | TN 07764          | YT 580005036      |
| DW A218756 | TN 39046          | YT 580008972      |
| DW A219024 | TY 00591-06165-81 | YT 580013445      |
| DX 1411740 | TY 00591-10918-81 |                   |

**Part Number - 380013-009-02**

**Spark Plug - W16EPR-U**

▼ OEM Reference

|                |             |            |
|----------------|-------------|------------|
| CT 1038083     | PL CR43CXLS | PL RN12YCC |
| DW A218377     | PL CR44NS   | PL RN14YC  |
| PL 1Y00-18-110 | PL ON11Y    |            |
| PL 3322        | PL ON12Y    |            |
| PL BPR5E       | PL R44LT    |            |
| PL CR425XLS    | PL RN11YCC  |            |

**Part Number - 380013-013-02**

**Spark Plug - Q20PR-U**

▼ OEM Reference

DW A223103  
NG BCP4E



**Part Number - 380013-014-02**

**Spark Plug - PT16EPR-L13**

▼ OEM Reference

|                |                   |                   |
|----------------|-------------------|-------------------|
| BO HR9DPX      | ND PT16EPR-L13    | TY 19111-U3161-71 |
| BO HR9DPY      | NI NF90420-01620  | TY 19111-U3330-71 |
| CL 923702      | TY 19111-31720-71 | TY 90098-66113-71 |
| CT 90420-01620 | TY 19111-31721-71 | TY 90420-01190-71 |
| HY 1389133     | TY 19111-90098-71 | YT 900015293      |
| MB 90420-01620 |                   |                   |

**Part Number - 380013-021**

**Spark Plug - W20ES-U**

▼ OEM Reference

|             |
|-------------|
| CT MD851097 |
| MB MD851097 |

**Part Number - 380013-012-02**

**Spark Plug - L14-U**

▼ OEM Reference

|            |             |                   |
|------------|-------------|-------------------|
| AC 232560  | CT 0041663  | TY 00591-07885-81 |
| AC 4513315 | CT 0631202  | TY 00591-07896-81 |
| AC 4613261 | CT 0676637  | TY 00591-32691-81 |
| AC 4660976 | CT 0972385  | TY 00591-50970-81 |
| AC 4810105 | CT 0973283  | TY 00591-50971-81 |
| AC 4905800 | CT 2A3643   | TY 00591-53307-81 |
| AC 4908597 | CT 353706   | TY 90098-64015    |
| AC 4910105 | CT 8N2630   | WK 110532         |
| AC 4916015 | DR C-86     | WK 209316         |
| BK 101359  | DR C-87     | WM 10-R-385       |
| BK 101527  | HY 0028758  | WM 10R1191        |
| BK 115923  | HY 0079161  | WM 20-7000680     |
| BK 116251  | HY 0123872  | WM 20-7000681     |
| BK 716D1   | HY 0138366  | WM 20-7000949     |
| BK 716J1   | HY 0197885  | WM 20-7100035     |
| CL 3739054 | HY 1312459  | YT 016254800      |
| CL 742159  | HY 1332693  | YT 016255000      |
| CL 784250  | HY 3001582  | YT 016255100      |
| CL 890215  | HY 3001585  | YT 031314500      |
| CL 890217  | HY 3001586  | YT 063194200      |
| CL 890221  | HY 3001590  | YT 150015100      |
| CL 890222  | HY 3002287  | YT 150112405      |
| CL 890227  | HY 3002348  | YT 150112406      |
| CL 890245  | HY 3002349  | YT 150112407      |
| CL 890246  | HY 3002575  | YT 150112408      |
| CL 890247  | HY 3002577  | YT 150112409      |
| CL 890255  | HY 3040014  | YT 150112410      |
| CL 890256  | HY 3050408  | YT 150112411      |
| CL 890264  | HY 3051151  | YT 150112413      |
| CL 890271  | HY 3051322  | YT 150112420      |
| CL 890272  | MB 2A3643   | YT 150112427      |
| CL 890273  | MB 8N2630   | YT 220007428      |
| CL 890274  | ME 41073    | YT 220010987      |
| CL 890276  | ME 41273    | YT 220011080      |
| CL 907621  | ME 41663    | YT 220011107      |
| CL 913628  | ND L14-U    | YT 220011205      |
| CL 913633  | NI CK913628 | YT 220052206      |
| CL 913638  | NP UD-16    | YT 509295802      |
| CL 913831  | PL 18-10    | YT 510764800      |
| CL 940328  | PL 18-4     | YT 517451800      |
| CN YD6     | PL 18-8     |                   |
| CT 0007954 | PL 18-9     |                   |

**Part Number - 380013-017-02**

**Spark Plug - W16S-U**

▼ OEM Reference

|             |                 |                   |
|-------------|-----------------|-------------------|
| AC 4907334  | CT MD997476     | ND W16S-U         |
| AC 4948894  | CT 851101       | PL 14-4           |
| AC 9001652  | CT 997476       | PL 14-5           |
| BK 716G1    | DW 8N2236       | PL 14R8           |
| CL 446583   | DW D141267      | TY 00591-05493-81 |
| CL 890210   | DW D700699      | TY 00591-10919-81 |
| CL 890219   | HY 0360046      | TY 00591-20174-81 |
| CL 890220   | HY 1312454      | TY 00591-33687-81 |
| CL 890225   | HY 3001588      | TY 00591-55310-81 |
| CL 890236   | HY 3002289      | TY 80098-76004-71 |
| CL 890252   | HY 360046       | TY 80098-76005-71 |
| CL 890253   | KO HE0052048-00 | YT 150112473      |
| CL 890265   | KO HE0110256-00 | YT 150112490      |
| CL 890267   | KO HE0110526-00 | YT 150112494      |
| CT 0099476  | KO HE40-2502314 |                   |
| CT 141267   | KO HE52892      |                   |
| CT 8N2236   | MB 8N2236       |                   |
| CT 99476    | MB MD997476     |                   |
| CT MD851101 | MB 997476       |                   |

**Part Number - 380013-018-01**

**Spark Plug - T20EPR-U**

▼ OEM Reference

|                |                |              |
|----------------|----------------|--------------|
| AB CR42CLTS    | CZ RS281YC     | MO AGSF32C   |
| AB R42CLTS     | CZ RS9YCC      | MO AGSF33C   |
| AB R42LTS      | CZ RS9YCX      | MO AGSF34C   |
| AB R42LTSM     | HY 1570595     | MO AGSF34EE  |
| AB R43LTS      | MO AWRP32      | MO AGSF34EEM |
| AB R43LTSE     | MO AWSF22C     | MO AGSF34FP  |
| AC DCR42CLTS   | MO AWSF22E     | NG BPR6EFS   |
| AC DR42CLTS    | MO AWSF32C     | NG BUR6EFSZ  |
| AC DR42LTS     | MO AWSFA32C    | NG TR5       |
| AO 103         | MO AGFS22FE13J | NG TR5-1     |
| AO 104         | MO AGRF2       | NG TR6       |
| AO 483         | MO AGRF22C     | ND T20EPR-U  |
| AO 764         | MO AGRF22C1    | ND T20EPRU   |
| AO 864         | MO AGRF22PP    | YT 580052996 |
| AO 985         | MO AGRF32      |              |
| AO 5144        | MO AGRF32C1    |              |
| AO 5164        | MO AGRP44      |              |
| CT A0000-14416 | MO AGSF22C     |              |
| CZ RS10LC      | MO AGSF24C     |              |

**Part Number - 380013-019-01**

**Spark Plug - W14EX-U**

▼ OEM Reference

|                |            |                   |
|----------------|------------|-------------------|
| AC 45NS        | ND W14EXU  | TY 00591-03633-81 |
| CL 1332679     | ND W14EX-U | TY 00591-32673-81 |
| CL 909377      | NG BP4E    | TY 00591-50969-81 |
| CL 912703      | NG BP4ES   | TY 90919-01056    |
| CT 9122000400  | NG BP4EY   | YT 150112478      |
| CT 91220-00400 | NG BP5EA   | YT 220034475      |
| HY 3057352     | PL 14G52   |                   |

**Part Number - 380013-016-02**

**Spark Plug - T14PR-U**

▼ OEM Reference

|              |             |                   |
|--------------|-------------|-------------------|
| BH H9BC      | JU 14148410 | TY 00591-50979-81 |
| BO 242219516 | ND T14PR-U  | TY 19111-U2120-71 |
| CL 922786    | PL 14RF42   | TY 90098-14785    |
| DR R-45-RB   | PL 14RF52   | YT 220013371      |
| HY 0281844   | PL 14RF62   | YT 580000628      |
| HY 1330468   | SB 8155723  |                   |

## Spark Plugs

Part Number - 380013-022-02

## Spark Plug - Partial Thread

▼ OEM Reference

|                |                |                |
|----------------|----------------|----------------|
| AC 22401-FU42A | JU 50459759    | NG FR2BD       |
| CT 91H20-12860 | KM 22401-FU42A | NI 22401-FU42A |
| CT A000035707  | KO 22401-FU42A | TC 22401-FU42A |
| HY 1720574     | MB 22401-FU42A | YT 550098613   |
| HY 1720575     | MB 91H20-12860 | YT 76000730    |
| HY 76000730    | MB A000035707  |                |

Part Number - 380105-051

## Spark Plug - W14LM-U

▼ OEM Reference

|          |            |
|----------|------------|
| AC DLM46 | ND W14LM-U |
| AC DLM49 | NG B4LM    |

## Fan Blades



Part Number - 380008-001-02

## Fan Blade - K21-K25

▼ OEM Reference

|                |
|----------------|
| AC 8779236     |
| KO 21060-FU40A |
| MB 91H20-12670 |
| NI 21060-GY360 |
| TC N21060FU40A |



Part Number - 380008-004-02

## Fan Blade - H20

▼ OEM Reference

|                |                |                   |
|----------------|----------------|-------------------|
| AC 4942359     | KO 21060-49003 | TC N-21060-48210  |
| CL 445268      | KO FN-200      | TY 00591-07192-81 |
| CL 7001677     | NI 21060-48210 | TY 00591-36864-81 |
| HY 3124790     | NI 21060-49001 |                   |
| KO 21060-48210 | NI 21060-49003 |                   |



Part Number - 380008-002-02

## Fan Blade - 4Y 6-7 Series

▼ OEM Reference

|                  |                   |                   |
|------------------|-------------------|-------------------|
| AC 8762498       | KO YM129900-44700 | TY 16361-23860-71 |
| KO YM129900-4470 | TC 212T1-05981    | YT 220034759      |



Part Number - 380008-005-02

## Fan Blade - 4G63-4G64 K-Series

▼ OEM Reference

|                |                |                   |
|----------------|----------------|-------------------|
| CT 91202-07400 | MB 91202-07400 | TY 00591-27429-81 |
| CT 91202-17400 | MB 91202-17400 |                   |



Part Number - 380008-003-02

## Fan Blade - H20 II

▼ OEM Reference

|                |                |                   |
|----------------|----------------|-------------------|
| AC 4901388     | KO FN-201      | TC N-21060-50K00  |
| DW D491452     | NI 21010-50K00 | TY 00591-36868-81 |
| KO 21060-50K00 | NI 21060-50K00 | TY 00591-54141-81 |
| KO 21060-87V00 | NI 21060-87V00 |                   |



Part Number - 380010-001-02

**Belt-Fan**

▼ OEM Reference

|               |                   |                   |
|---------------|-------------------|-------------------|
| AC 8761967    | KM 8761967        | NI 11720-87V10    |
| CL 2781527    | KO 11720-52H01-F1 | NI 11720-K4080    |
| CT A000013592 | KO 11720-87V10    | TC N-11720-K4080  |
| DW D490878    | KO 11720-K4080    | TY 00591-75559-81 |
| KM 4968642    | KO 11720-K4080A   |                   |

Part Number - 380010-003-02

**Belt-Fan**

▼ OEM Reference

|                |                   |                   |
|----------------|-------------------|-------------------|
| CL 352780      | KO 02117-23523    | TY 90916-02975-71 |
| CL 3490402     | LP 156-1648       | TY 00591-51028-81 |
| CT 91H20-03350 | LP 156-17484      | TY 90916-02975-71 |
| CT 9L2248      | LP 156-9001       | TY 295675600      |
| HY 809400      | NI 02117-20021    | TY 900534806      |
| HY 3057598     | NI 02117-20021    | TY 220011118      |
| HY 3064467     | TC 20801-04081    | TY 220052043      |
| HY 104728      | TY 16372-13010-71 | TY 295675700      |
| HY 2039256     | TY 89322-76009-71 |                   |

Part Number - 380010-004-02

**Belt-Fan**

▼ OEM Reference

|             |                   |                   |
|-------------|-------------------|-------------------|
| CL 2814061  | HY 3061904        | TY 00591-33845-81 |
| CL 3790816  | HY 3099227        | TY 00591-33876-81 |
| CT 1017158  | MB 1017158        | TY 00591-33878-81 |
| CT MM115231 | MB MM115231       | TY 00591-51007-81 |
| HY 1526078  | NI 11720-J0300    | TY 00591-53127-81 |
| HY 188643   | TC 20801-04331    | TY 00591-55347-81 |
| HY 2339656  | TY 00591-06095-81 | TY 580035882      |

Part Number - 380010-005-02

**Belt-Fan**

▼ OEM Reference

|                |                |                |
|----------------|----------------|----------------|
| CT 91921-06300 | MB 91921-06300 | NI 11720-FM010 |
| CT 91H20-02560 | MB 91H20-02560 | NI 02117-21521 |
| KO 02117-21521 | MB 91H2002560  |                |

Part Number - 380010-011-02

**Belt-Fan**

▼ OEM Reference

|              |
|--------------|
| DW A213971   |
| LP 156-20442 |

Part Number - 380101-813

**Belt-Fan**

▼ OEM Reference

|                |                |                   |
|----------------|----------------|-------------------|
| CT 05910-10046 | NI 02117-16523 | TY 16371-76006-71 |
| MB 05910-10046 | NI 21067-47605 | TY 904143100      |

Part Number - 380101-836

**Belt-Fan**

▼ OEM Reference

|                |                |                |
|----------------|----------------|----------------|
| BR 11720-10H05 | CT 91402-03400 | MB 91402-03400 |
| CT 91402-01200 | MB 91402-01200 | NI 11720-10H05 |

Part Number - 380010-021-02

**Belt, Alternator-Fan-Water Pump**

▼ OEM Reference  
HY 2088870

Part Number - 380010-020-02

**Belt, Alternator-Fan-Water Pump**

▼ OEM Reference  
HY 2090051

Part Number - 380101-819

**Belt-Fan**

▼ OEM Reference

|                |                   |                   |
|----------------|-------------------|-------------------|
| AC 4707731     | HY 355150         | TY 16374-20100-71 |
| AC 8760137     | JU 1408743        | TY 89322-76005-71 |
| CL 659886      | KO 4948980        | TY 056811900      |
| CL 7000354     | MZ 484418381      | TY 220016975      |
| CL 997412      | NI TJF0118381A    | TY 220034789      |
| CT 50211566    | TC 91367-16150    | TY 220042752      |
| CT 50219050    | TY 00591-11097-81 | TY 220052049      |
| CT 971654      | TY 00591-33851-81 | TY 449089134      |
| CT A0000-25324 | TY 00591-51024-81 | TY 580046374      |
| HY 175911      | TY 00591-72208-81 | TY 900890818      |
| HY 0355150     | TY 00591-76336-81 | TY 901303863      |

Part Number - 380010-002-02

**Belt-Fan**

▼ OEM Reference

|               |                   |                   |
|---------------|-------------------|-------------------|
| AC 4942145    | HY 191845         | NI 02117-01011    |
| AC 4966574    | HY 370411         | NI 02117-03011    |
| BK 101286     | HY 374011         | NI 11720-B1100    |
| BK 9491000624 | HY 3000555        | NI 11720-B1101    |
| CL 2361378    | HY 3051878        | NI 11720-L1101    |
| CT 99841      | KA 4942145        | NI 11720-Y4400    |
| CT 099841     | KA 4966574        | TC 20801-04261    |
| CT 62923      | KO 11720-B1101L   | TC 11720-B1101    |
| CT 99481      | KO 11720-B1101    | TC N-11720-B1101  |
| CT 308302     | KO 11720-L1102    | TC N-11720-Y4400  |
| CT 347191     | LP 156-1001       | TY 00591-06238-81 |
| CT 347192     | LP 156-13395      | TY 00591-07109-81 |
| CT 347196     | LP 156-13415      | TY 00591-33834-81 |
| CT 0308302    | MB 2N159          | TY 00591-33846-81 |
| CT 0347191    | NI 02117-01011-F1 | TY 00591-51009-81 |
| CT 0347192    | NI 02117-02011-F1 | TY 00591-51010-81 |
| CT 0347196    | NI 11720-B1101F1  | TY 00591-51014-81 |
| CT 062923     | NI 11720-B1101-F1 | TY 00591-55397-81 |
| CT 099481     | NI 11720-Y4400    |                   |
| CT 2N0159     | NI 20801-04261    |                   |

Part Number - 380010-006-02

**Belt-Fan**

▼ OEM Reference

|                |                   |                   |
|----------------|-------------------|-------------------|
| CL 7000350     | LP 156-17415      | TY 00591-33843-81 |
| CL 7000353     | MB 1039078        | TY 00591-33850-81 |
| CT 1039078     | MB 91401-09700    | TY 00591-33855-81 |
| CT 216256      | MB 91401-09800    | TY 00591-33880-81 |
| CT 91401-09800 | TY 00591-33869-81 | TY 00591-42813-81 |
| HY 3000569     | TY 00591-55348-81 | TY 00591-51025-81 |
| LP 156-1183    | TY 16374-32870-71 | TY 00591-75169-81 |
| LP 156-16424   | TY 00591-10954-81 |                   |
| LP 156-16631   | TY 00591-10963-81 |                   |

## Belts

Part Number - 380010-009-02

**Belt-Fan**

▼ OEM Reference

|             |                  |                   |
|-------------|------------------|-------------------|
| CL 659050   | KO 11720-F2700   | TY 00591-33877-81 |
| CL 920231   | MB 1041623       | TY 00591-33879-81 |
| CL 930768   | MB MM407440      | TY 00591-55359-81 |
| CT 1041623  | NI 01978-11004   | TY 00591-55375-81 |
| CT 1041823  | NI 11720-F2700   | TY 00591-74115-81 |
| CT 2W2530   | NI 21140-90301   | TY 00591-74817-81 |
| CT MM407440 | NI CK930768      | YT 580035883      |
| DW A273823  | TC 20801-04101   | YT 220042751      |
| HY 1526079  | TC N-02117-00511 |                   |

Part Number - 380010-010-02

**Belt-Fan**

▼ OEM Reference

|            |                   |                   |
|------------|-------------------|-------------------|
| AC 4860509 | HY 123577         | TY 99322-01170-71 |
| BK 9265026 | HY 0123577        | TY 00591-10965-81 |
| CL 448458  | JU 14087210       | TY 00591-51011-81 |
| CL 774608  | KO 4860509        | TY 90916-02952-71 |
| CT 971472  | LP 156-1182       | WM 10A16423       |
| HY 860712  | LP 156-13465      | YT 220024785      |
| HY 86071   | LP 156-16460      | YT 220001588      |
| HY 0086071 | PM BM-15-1        | YT 449089003      |
| HY 111107  | TY 90916-02952-71 |                   |
| HY 0111107 | TY 99322-01170    |                   |

Part Number - 380030-096

**Belt-Fan**

▼ OEM Reference

|           |            |                 |
|-----------|------------|-----------------|
| CL 799544 | DW D141101 | KM 4965293      |
| CT 5M8137 | HY 353393  | KO 6204-81-3270 |

Part Number - 380010-013-02

**Belt-Fan**

▼ OEM Reference

|                |                |                |
|----------------|----------------|----------------|
| CT 05910-10043 | HY 1384008     | NI 01978-11134 |
| CT 91801-08600 | HY 1457875     | NI 19104-K7202 |
| HY 1368841     | NI 01978-11104 | YT 9013038-36  |

Part Number - 380010-014-02

**Belt-Fan**

▼ OEM Reference

|                  |                   |              |
|------------------|-------------------|--------------|
| CT 91801-07600   | HY 1495412        | YT 580024157 |
| DW 65.96801-0004 | NI 11720-10H06    | YT 582011391 |
| HY 108102        | TY 16373-30530-71 |              |
| HY 1361847       | YT 505961521      |              |

Part Number - 380010-012-02

**Belt-Fan**

▼ OEM Reference

|               |                   |                   |
|---------------|-------------------|-------------------|
| BK LFM8105471 | KO 11720-K7201    | TY 00591-33863-81 |
| CL 913259     | NI 11720-69200    | TY 00591-33868-81 |
| CL 3773658    | NI 11720-K7201    | TY 00591-51008-81 |
| CL 7000351    | NI 11720-N9515    | TY 00591-55374-81 |
| HY 172895     | NI 21067-38800    | YT 220002518      |
| HY 233965     | NI 21067-K7201    | YT 220052061      |
| HY 807004     | TY 00591-02732-81 |                   |
| HY 3051858    | TY 00591-07107-81 |                   |

Part Number - 380030-212

**Belt-Serpentine**

▼ OEM Reference

|              |
|--------------|
| HY 2053666   |
| YT 580034354 |

Part Number - 380010-008-02

**Belt-Timing**

▼ OEM Reference

|               |                   |                   |
|---------------|-------------------|-------------------|
| CL 7000659    | JU 14364210       | TY 00591-34661-81 |
| CT A000000345 | JU 14704390       | TY 00591-53504-81 |
| HY 1361733    | LP 100-FE10       | TY 00591-54549-81 |
| HY 3057775    | LP 124-1294       | YT 220034390      |
| HY 3061901    | LP 138-1004       | YT 220100725      |
| HY 3115283    | MZ FE09-12-205    | YT 901294816      |
| JU 147043904  | TY 00591-22425-81 | YT 901294829      |

Part Number - 380030-101

**Belt-Timing**

▼ OEM Reference

|             |                   |                   |
|-------------|-------------------|-------------------|
| CL 7000647  | JU 144118105      | TY 00591-54055-81 |
| CT 14411810 | LP 100-F227       | YT 504258756      |
| HY 2028852  | LP 124-4003       | YT 901577816      |
| JU 1441181  | MB 14411810       |                   |
| JU 14411810 | TY 00591-34628-81 |                   |

Part Number - 380030-104

**Belt-Timing**

▼ OEM Reference

|           |
|-----------|
| CL 918706 |
|-----------|

Part Number - 380030-179

**Belt-Timing**

▼ OEM Reference

|             |            |             |
|-------------|------------|-------------|
| CL 920294   | DW A252036 | MB MD197137 |
| CT MD140227 |            |             |

Part Number - 380010-015-02

**Belt-Timing**

▼ OEM Reference

|              |
|--------------|
| HY 1553762   |
| YT 580046902 |

Part Number - 380010-016-02

**Belt-Timing**

▼ OEM Reference

|              |
|--------------|
| HY 1584507   |
| YT 580057187 |



Part Number - 380050-001  
**Oil Seal**

| O.D         | I.D.       | O. Width  |
|-------------|------------|-----------|
| 100.15 (MM) | 69.05 (MM) | 9.70 (MM) |

▼ OEM Reference  
HY 1523530



Part Number - 380060-023  
**Oil Seal**

| O.D         | I.D.        | O. Width   |
|-------------|-------------|------------|
| 160.00 (MM) | 130.00 (MM) | 12.00 (MM) |

▼ OEM Reference  
CT 8C5211 CT 9X7687 DW D700305



Part Number - 380050-002  
**Oil Seal**

| O.D         | I.D.       | O. Width   |
|-------------|------------|------------|
| 125.46 (MM) | 89.26 (MM) | 14.90 (MM) |

▼ OEM Reference

|            |                   |                   |
|------------|-------------------|-------------------|
| CL 7003887 | JU 14374480       | TY 00591-76873-81 |
| HY 2027701 | TY 00591-33124-81 | YT 220020044      |
| HY 2027817 | TY 00591-54664-81 | YT 911086300      |
| JU 1437448 | TY 00591-71480-81 | YT 920803300      |



Part Number - 380050-046  
**Oil Seal**

| O.D         | I.D.       | O. Width   |
|-------------|------------|------------|
| 105.00 (MM) | 80.00 (MM) | 13.00 (MM) |

▼ OEM Reference

|             |                 |                |
|-------------|-----------------|----------------|
| HAM 4940277 | HAM 8772429     | KO 07012-00080 |
| HAM 4940278 | HAM 07012-00080 | TC 24843-02051 |
| HAM 4942457 | KM 4942457      |                |



Part Number - 380050-007  
**Oil Seal**

| O.D        | I.D.       | O. Width  |
|------------|------------|-----------|
| 94.90 (MM) | 63.27 (MM) | 8.08 (MM) |

▼ OEM Reference

|            |                   |              |
|------------|-------------------|--------------|
| CL 7003807 | JU 14458080       | YT 220029615 |
| CT 215416  | JU 14473480       | YT 220075001 |
| HY 44542   | SL S200851        | YT 504224218 |
| HY 44542   | TY 00591-32069-81 |              |
| HY 3137615 | TY 00591-60402-81 |              |



Part Number - 380050-047  
**Oil Seal**

| O.D        | I.D.       | O. Width  |
|------------|------------|-----------|
| 52.20 (MM) | 41.59 (MM) | 7.92 (MM) |

▼ OEM Reference

|                  |                 |
|------------------|-----------------|
| HAM 8779491      | KM 4948613      |
| HAM 3EA-22-11210 | KO 3EA-22-11210 |



Part Number - 380050-011  
**Oil Seal**

| O.D        | I.D.       | O. Width   |
|------------|------------|------------|
| 72.50 (MM) | 51.20 (MM) | 11.40 (MM) |

▼ OEM Reference

|           |                   |                   |
|-----------|-------------------|-------------------|
| CT 973851 | HY 266733         | TY 00591-52483-81 |
| CT 973851 | HY 3057503        | YT 220037503      |
| HY 153718 | TY 00591-20561-81 | YT 220075023      |
| HY 153718 | TY 00591-32092-81 | YT 504224242      |



Part Number - 380050-048  
**Oil Seal**

| O.D         | I.D.       | O. Width   |
|-------------|------------|------------|
| 130.30 (MM) | 88.69 (MM) | 14.95 (MM) |

▼ OEM Reference

|             |                   |                 |
|-------------|-------------------|-----------------|
| AC 4940905  | HAM 3EB-21-15130  | KM 4940905      |
| HAM 4940905 | HAM 3EB-21-15130A | KO 3EB-21-15130 |
| HAM 8777919 | HAM 3EB-21-15130L |                 |



Part Number - 380030-035  
**Oil Seal**

| O.D        | I.D.       | O. Width  |
|------------|------------|-----------|
| 68.10 (MM) | 57.25 (MM) | 8.85 (MM) |

▼ OEM Reference  
KM 4944592 KO 3EC-21-15140



Part Number - 380030-042  
**Oil Seal**

| O.D        | I.D.       | O. Width |
|------------|------------|----------|
| 55.14 (MM) | 41.05 (MM) | 6.9 (MM) |

▼ OEM Reference  
TY 42125-22000-71 TY 42125-U2100-71



Part Number - 380050-045  
**Oil Seal**

| O.D        | I.D.       | O. Width  |
|------------|------------|-----------|
| 60.10 (MM) | 46.95 (MM) | 7.88 (MM) |

▼ OEM Reference

|             |                  |                 |
|-------------|------------------|-----------------|
| AC 8776236  | HAM 3EB-21-15140 | KM 8776236      |
| HAM 8776236 | KM 4940906       | KO 3EB-21-15140 |



Part Number - 380060-001  
**Oil Seal**

| O.D         | I.D.       | O. Width   |
|-------------|------------|------------|
| 105.00 (MM) | 75.00 (MM) | 15.00 (MM) |

▼ OEM Reference  
CT 91B33-01100 NI 43090-00H00



Part Number - 380060-002  
**Oil Seal**

| O.D         | I.D.       | O. Width  |
|-------------|------------|-----------|
| 111.44 (MM) | 84.70 (MM) | 9.36 (MM) |

▼ OEM Reference  
HY 1354997      YT 505965509



Part Number - 380050-027  
**Oil Seal**

| O.D         | I.D.       | O. Width   |
|-------------|------------|------------|
| 142.30 (MM) | 91.58 (MM) | 14.34 (MM) |

▼ OEM Reference  
NI 43090-22H00



Part Number - 380060-003  
**Oil Seal**

| O.D        | I.D.       | O. Width  |
|------------|------------|-----------|
| 90.18 (MM) | 67.35 (MM) | 7.90 (MM) |

▼ OEM Reference  
HY 325568      YT 504224208



Part Number - 380050-033  
**Oil Seal, Drive Axle**

| O.D        | I.D.       | O. Width  |
|------------|------------|-----------|
| 55.00 (MM) | 45.00 (MM) | 6.00 (MM) |

▼ OEM Reference  
BK 219990      LI 219990      TY 00591-41351-81  
CL 7003866      LI 241238      TY 00591-54654-81  
HY 3042586      NI 43533-L1100      YT 220054163  
TY 00591-07374-81



Part Number - 380060-004  
**Oil Seal**

| O.D         | I.D.       | O. Width  |
|-------------|------------|-----------|
| 115.00 (MM) | 80.00 (MM) | 6.00 (MM) |

▼ OEM Reference  
CT 6V8407      DW D700581



Part Number - 380050-030  
**Oil Seal**

| O.D        | I.D.       | O. Width  |
|------------|------------|-----------|
| 20.10 (MM) | 16.00 (MM) | 2.35 (MM) |

▼ OEM Reference  
HY 3025861      TY 00591-07432-81      TY 00591-54658-81  
NI 48522-00H00      TY 00591-41385-81      YT 22024966



Part Number - 380060-005  
**Oil Seal**

| O.D         | I.D.       | O. Width   |
|-------------|------------|------------|
| 105.12 (MM) | 73.83 (MM) | 11.90 (MM) |

▼ OEM Reference  
TY 42415-10480-71



Part Number - 380050-031  
**Oil Seal**

| O.D        | I.D.       | O. Width  |
|------------|------------|-----------|
| 39.00 (MM) | 27.00 (MM) | 3.50 (MM) |

▼ OEM Reference  
CT 91E43-01800      MB 91E43-01800      NI 48525-FK000



Part Number - 380060-006  
**Oil Seal**

| O.D         | I.D.       | O. Width   |
|-------------|------------|------------|
| 100.17 (MM) | 78.52 (MM) | 12.95 (MM) |

▼ OEM Reference  
KM 4949337  
KO 3EB-22-21160



Part Number - 380060-007  
**Oil Seal**

| O.D         | I.D.       | O. Width  |
|-------------|------------|-----------|
| 103.84 (MM) | 74.68 (MM) | 7.80 (MM) |

▼ OEM Reference  
CT 91E43-02300  
NI 40227-FK000



Part Number - 380050-049  
**Oil Seal**

| O.D         | I.D.       | O. Width | I. Width   |
|-------------|------------|----------|------------|
| 124.75 (MM) | 57.05 (MM) | 7.5 (MM) | 12.80 (MM) |

▼ OEM Reference  
AC 8761245      HAM 3EB-21-32180      KO 3EB-21-32180  
HAM 8761245      KM 8761245



Part Number - 380060-008  
**Oil Seal**

| O.D         | I.D.        | O. Width   |
|-------------|-------------|------------|
| 145.11 (MM) | 109.27 (MM) | 15.80 (MM) |

▼ OEM Reference  
KM 8765021  
KO 8765021  
KO 3EC-21-36250



Part Number - 380060-009

**Oil Seal**

| O.D         | I.D.       | O. Width  |
|-------------|------------|-----------|
| 105.14 (MM) | 37.85 (MM) | 9.87 (MM) |

▼ OEM Reference  
TY 42415-11630-71



Part Number - 380060-015

**Oil Seal**

| O.D        | I.D.       | O. Width   |
|------------|------------|------------|
| 62.00 (MM) | 85.00 (MM) | 12.00 (MM) |

▼ OEM Reference  
CT 9X7695  
DW D700306



Part Number - 380060-010

**Oil Seal**

| O.D        | I.D.       | O. Width  |
|------------|------------|-----------|
| 53.19 (MM) | 41.26 (MM) | 6.70 (MM) |

▼ OEM Reference  
TY 42125-23320-71



Part Number - 380060-016

**Oil Seal**

| O.D        | I.D.       | O. Width   |
|------------|------------|------------|
| 95.13 (MM) | 69.42 (MM) | 12.66 (MM) |

▼ OEM Reference  
MB 93433-12400



Part Number - 380060-011

**Oil Seal, Steer Axle**

| O.D        | I.D.       | O. Width  |
|------------|------------|-----------|
| 21.00 (MM) | 17.00 (MM) | 2.75 (MM) |

▼ OEM Reference  
MB 91A43-02300  
NI 48522-FJ101



Part Number - 380060-017

**Oil Seal**

| O.D        | I.D.       | O. Width   |
|------------|------------|------------|
| 47.00 (MM) | 38.00 (MM) | 10.00 (MM) |

▼ OEM Reference  
NI 43252-J2000



Part Number - 380060-012

**Oil Seal**

| O.D         | I.D.       | O. Width   |
|-------------|------------|------------|
| 114.43 (MM) | 78.09 (MM) | 16.76 (MM) |

▼ OEM Reference  
CL 2786180



Part Number - 380060-018

**Oil Seal**

| O.D         | I.D.       | O. Width   |
|-------------|------------|------------|
| 130.50 (MM) | 95.25 (MM) | 22.70 (MM) |

▼ OEM Reference  
CL 245020



Part Number - 380060-013

**Oil Seal**

| O.D        | I.D.       | O. Width   |
|------------|------------|------------|
| 90.22 (MM) | 57.75 (MM) | 10.67 (MM) |

▼ OEM Reference  
HY 2021557  
KM 4940496  
KO 3EA-21-14140  
YT 921949300



Part Number - 380060-019

**Oil Seal**

| O.D         | I.D.       | O. Width   |
|-------------|------------|------------|
| 110.00 (MM) | 70.00 (MM) | 13.00 (MM) |

▼ OEM Reference  
KO 3EA-21-14131  
KM 4940495



Part Number - 380060-014

**Oil Seal**

| O.D         | I.D.       | O. Width   |
|-------------|------------|------------|
| 115.00 (MM) | 90.00 (MM) | 13.00 (MM) |

▼ OEM Reference  
HY 300801  
YT 50595912



Part Number - 380030-145

**Oil Seal**

| O.D         | I.D.       | O. Width   |
|-------------|------------|------------|
| 110.22 (MM) | 74.56 (MM) | 13.25 (MM) |

▼ OEM Reference  
HY 2021554  
YT 920802300

# Seals



Part Number - 380060-021  
**Oil Seal**

| O.D        | I.D.       | O. Width   |
|------------|------------|------------|
| 80.10 (MM) | 56.46 (MM) | 11.90 (MM) |

▼ OEM Reference  
HY 2021898  
YT 958506995



Part Number - 380060-024  
**Oil Seal**

| O.D        | I.D.       | O. Width   |
|------------|------------|------------|
| 82.23 (MM) | 58.61 (MM) | 11.80 (MM) |

▼ OEM Reference  
MB 91B33-02700  
NI 43254-FJ100



Part Number - 380103-979  
**Oil Seal**

| O.D         | I.D.       | O. Width   |
|-------------|------------|------------|
| 120.12 (MM) | 91.95 (MM) | 12.15 (MM) |

▼ OEM Reference  
TY 42415-22800-71



Part Number - 380060-025  
**Oil Seal**

| O.D        | I.D.       | O. Width  |
|------------|------------|-----------|
| 88.25 (MM) | 57.57 (MM) | 6.80 (MM) |

▼ OEM Reference  
TY 43821-22000-71



Part Number - 380060-022  
**Oil Seal, Steel Axle**

| O.D        | I.D.       | O. Width  |
|------------|------------|-----------|
| 33.00 (MM) | 25.00 (MM) | 4.00 (MM) |

▼ OEM Reference  
HY 2026739  
YT 906150100



Part Number - 380060-026  
**Oil Seal**

| O.D        | I.D.       | O. Width  |
|------------|------------|-----------|
| 96.00 (MM) | 64.75 (MM) | 8.30 (MM) |

▼ OEM Reference  
KO 3EB-24-41330



Part Number - 380104-004  
**Oil Seal**

| O.D         | I.D.       | O. Width  |
|-------------|------------|-----------|
| 103.00 (MM) | 51.80 (MM) | 8.30 (MM) |

▼ OEM Reference  
CT 91233-07900  
MB 91233-07900



Part Number - 380060-020  
**Dust Seal**

| O.D        | I.D.       | O. Width  |
|------------|------------|-----------|
| 34.99 (MM) | 25.13 (MM) | 5.82 (MM) |

▼ OEM Reference  
MB 91444-11400  
NI 48525-FJ100



Part Number - 380103-969  
**Oil Seal**

| O.D        | I.D.       | O. Width  |
|------------|------------|-----------|
| 93.85 (MM) | 59.61 (MM) | 7.50 (MM) |

▼ OEM Reference

|                |                |                   |
|----------------|----------------|-------------------|
| CL 7003865     | MB 91B43-02300 | TC 40227-04H00    |
| CT 214765      | NI 32404       | TY 00591-07354-81 |
| CT 91B43-02300 | NI 40227-02K00 | TY 00591-41350-81 |
| HY 3046730     | NI 40227-04H00 | TY 00591-54653-81 |
| MB 214765      | NI 40227-04K00 | YT 220070983      |



Part Number - 380104-026  
**Oil Seal - Rear**

| O.D         | I.D.       | O. Width  |
|-------------|------------|-----------|
| 110.30 (MM) | 90.20 (MM) | 8.74 (MM) |

▼ OEM Reference

|             |                   |                   |
|-------------|-------------------|-------------------|
| CL 447599   | HY 76001421       | TY 00591-41400-81 |
| CL 7003892  | MZ F802-11-399    | TY 00591-54676-81 |
| CT 14364040 | TC T-F802-11-399  | TY 00591-60150-81 |
| HY 1361691  | TY 00591-22412-81 | YT 220100689      |
| HY 3057772  | TY 00591-22424-81 | YT 900889814      |
| HY 324772   | TY 00591-41372-81 | YT 901292814      |



Part Number - 380103-941  
**Oil Seal**

| O.D        | I.D.       | O. Width   |
|------------|------------|------------|
| 90.15 (MM) | 63.78 (MM) | 12.75 (MM) |

▼ OEM Reference

|            |              |
|------------|--------------|
| HY 2028621 | YT 2028621   |
| HY 4615139 | YT 929261300 |



Part Number - 380104-009  
**Oil Seal**

| O.D        | I.D.       | O. Width   |
|------------|------------|------------|
| 95.13 (MM) | 69.42 (MM) | 12.66 (MM) |

▼ OEM Reference

|                |                |              |
|----------------|----------------|--------------|
| CT 91E33-01800 | MB 91E33-01800 | TY 800144064 |
| HY 800144064   | NI 43254-FK000 |              |



## Pipes



Part Number - 380007-001-02

### Exhaust Pipe

▼ OEM Reference  
AC 4949214  
KO 3EB-03-22110  
TY 00591-06324-81



Part Number - 380007-005-02

### Exhaust Pipe

▼ OEM Reference  
TY 17401-16600-71



Part Number - 380007-002-02

### Exhaust Pipe

▼ OEM Reference  
KO 3EB-03-35311



Part Number - 380103-791

### Muffler

▼ OEM Reference  
NI 20100-FC301  
NI 20100-FC30A  
NI 20100-GH10A



Part Number - 380007-003-02

### Muffler

▼ OEM Reference  
KO 3EB-03-A6610

## Transmission/Drive Train



Part Number - 380006-013-01

### Transmission Charging Pump

▼ OEM Reference  
KO 30B-13-11200



Part Number - 351096-120

### Strainer & Cup

▼ OEM Reference

|                |                |                |
|----------------|----------------|----------------|
| BR 31728-FJ10B | CT 91A2408201  | MB 91A2408200  |
| CT 50443383    | JU 50443383    | MB 91A2408201  |
| CT 91A24-08200 | MB 50443383    | NI 31728-FJ10B |
| CT 91A24-08201 | MB 91A24-08200 |                |
| CT 91A2408200  | MB 91A24-08201 |                |



Part Number - 380001-014-02

### Torque Converter (Brand New)

▼ OEM Reference  
HAM 30B-13-11110  
KO 30B-13-11110



Part Number - 380001-022

### Torque Converter

▼ OEM Reference  
KO AS351200-13020  
KO DC6A26500000



Part Number - 380030-001

**Accelerator Unit**

▼ OEM Reference

|                |                 |                |
|----------------|-----------------|----------------|
| AC 8772287     | HAM 18919-AM810 | NI 18919-AM810 |
| CT 91A51-08400 | KM 8772287      |                |
| HAM 8772287    | KO 18919-AM810  |                |



Part Number - 380030-150

**Anchor Bolt**

▼ OEM Reference

HY 1369357  
YT 518801644



Part Number - 380030-011

**Bolt**

▼ OEM Reference

|             |                  |                 |
|-------------|------------------|-----------------|
| AC 4941509  | HAM 34A-24-11220 | KO 34A-24-11220 |
| HAM 4941509 | KM 4941509       |                 |



Part Number - 380030-012

**Bolt**

▼ OEM Reference

|                 |                  |                 |
|-----------------|------------------|-----------------|
| AC 300-27-13251 | HAM 4941592      | KO 300-27-13251 |
| AC 34B-24-11220 | HAM 34B-24-11221 | KO 34B-24-11220 |
| AC 4941592      | KM 4941592       |                 |
| CL 444932       | KO 34B-24-11221  |                 |



Part Number - 380030-013

**Bolt**

▼ OEM Reference

|             |                  |                 |
|-------------|------------------|-----------------|
| AC 4949338  | HAM 3EB-22-21170 | KO 3EB-22-21170 |
| HAM 4949338 | KM 4949338       |                 |



Part Number - 380030-109

**Bolt**

▼ OEM Reference

HY 118714  
YT 504226246



Part Number - 380030-110

**Bolt, Tie Rod**

▼ OEM Reference

KM 4949361  
KO 3EB-24-21581



Part Number - 380030-014

**Bolt, Tie Rod**

▼ OEM Reference

KM 8761511  
KO 3EB-24-35130



Part Number - 380030-015

**Bolt, Tie Rod**

▼ OEM Reference

KM 8761509  
KO 3EB-24-35140



Part Number - 380030-105

**Bolt, Tie Rod**

▼ OEM Reference

KM 8764087  
KO 8764087  
KO 3EC-24-31690  
KO 3ED-24-41270



Part Number - 380030-066

**Pin, Tie Rod**

▼ OEM Reference

TY 43731-23442-71



Part Number - 380030-050

**Bolt**

▼ OEM Reference

HY 2027593  
HY 2037408  
YT 903758300



Part Number - 380030-139

**Bolt**

▼ OEM Reference

CL 7003323  
HY 2021798  
YT 900525100



Part Number - 380030-250

**Bolt, Upper Pin**

▼ OEM Reference

YT 272106000



Part Number - 380030-146

**Bolt**

▼ OEM Reference

CL 7003288  
HY 339529  
YT 505972584



Part Number - 380030-051

**Bolt**

▼ OEM Reference

|            |              |
|------------|--------------|
| HY 1502276 | YT 580061342 |
| HY 2027595 | YT 903775300 |



Part Number - 380030-089

**Bolt, Tie Rod**

▼ OEM Reference  
 KM 4949344  
 KO 3EB-24-A2570



Part Number - 380030-055

**Bolt**

▼ OEM Reference  
 KM 4949328  
 KO 3EB-21-25170



Part Number - 380050-029

**Bolt**

▼ OEM Reference  
 CL 445458 TC 43225-L1300  
 NI 43225-L1300 TY 80114-76006-71



Part Number - 380100-599

**Bolt**

▼ OEM Reference  
 HY 1509870  
 YT 580036619



Part Number - 380030-135

**Cylinder Head Bolt**

▼ OEM Reference  
 NI 11056-FY500  
 NI 11056-FY50A



Part Number - 380030-238

**Cylinder Head Bolt**

▼ OEM Reference  
 HY 1584206  
 YT 580057036



Part Number - 380030-052

**Tie Rod Pin**

▼ OEM Reference  
 HY 2021793 SY HY2021793 YT YT911982300  
 HY HY2021793 YT 911982300



Part Number - 380030-149

**Tie Rod Pin**

▼ OEM Reference  
 HY 1568271  
 HY 326498  
 YT 580052360



Part Number - 380030-249

**Pedal - Dowel Pin**

▼ OEM Reference  
 CT F2850-05016  
 MB F2850-05016



Part Number - 380030-093

**Tie Rod Pin**

▼ OEM Reference  
 TY 43731-13311-71  
 TY 43731-13360-71

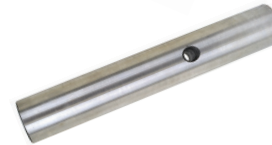

Part Number - 380030-115

**King Pin**

▼ OEM Reference  
 CT 6R6961  
 DW D700576



Part Number - 380030-103

**King Pin**

▼ OEM Reference  
 TY 43232-9NML8-71 TY 43232-U3270-71  
 TY 43232-U2170-71 TY 43232-U3271-71



Part Number - 380030-335

**King Pin, Steering Knuckle (RH)**

▼ OEM Reference  
 TY 43231-U2260-71



Part Number - 380030-197

**Chain Anchor Pin**

▼ OEM Reference  
 HY 323161  
 YT 504071777



Part Number - 380030-242

**Chain Anchor Pin**

▼ OEM Reference  
 HY 147485 YT 517056800  
 HY 161005 YT 519686300  
 YT 504242207



Part Number - 380030-088

**King Pin Repair Kit**

▼ OEM Reference  
 TY 04432-10100-71 TY 04432-U1030-71  
 TY 04432-10120-71 TY 04432-U2020-71  
 TY 04432-20061-71 TY 04432-U2021-71  
 TY 04432-20080-71



Part Number - 380030-165

**King Pin Repair Kit**

▼ OEM Reference  
 TY 04432-U1010-71



Part Number - 380030-037

**Steer Link Pin**

▼ OEM Reference  
 CT 908169  
 DW D700583



Part Number - 380030-169

**Tie Rod Pin**

▼ OEM Reference  
 TY 43741-U2100-71



Part Number - 380030-016

**Nut**

▼ OEM Reference

AC 4941586      HAM 34B-21-14151      KO 34B-21-14151  
 HAM 4941586      KM 4941586



Part Number - 380030-019

**Nut**

▼ OEM Reference

|                  |                   |                   |
|------------------|-------------------|-------------------|
| AC 4944661       | HY 1374550        | TY 90179-12003-71 |
| CT 05634-01200   | HY 2021595        | TY 94186-11200-71 |
| CT 91446-04300   | KM 4944661        | YT 580003984      |
| HAM 4944661      | KO 3EC-30-11490   | YT 901202809      |
| HAM 3EC-30-11490 | TC 271F6-42531    | YT 912471303      |
| HY 1312624       | TC 44217-22H00    |                   |
| HY 1360799       | TY 84186-76001-71 |                   |



Part Number - 380030-102

**Nut**

▼ OEM Reference

KO 4944952      KO 310-30-26310      KO 3EC-21-36811  
 KO 8771656      KO 3EC-21-36810



Part Number - 380030-017

**Nut**

▼ OEM Reference

CT F2335-16000      KO 01593-31613      NI 08911-0461A  
 KM 8761510      NI 08911-04610      TY 90171-16001-71



Part Number - 380030-143

**Nut**

▼ OEM Reference

HY 2021799      TC 22513-72011      TY 90179-12004-71  
 KM 4941745      TY 80942-76002-71      YT 900126301  
 KO 358-27-11230



Part Number - 380030-065

**Nut**

▼ OEM Reference

KM 4940132  
 KO 01582-11815



Part Number - 380030-116

**Nut, Castle**

▼ OEM Reference

KM 4940141      KO 8764088      KO 01593-11813  
 KO 4940141      KO 8771486      KO 01593-31813  
 KO 4972207



Part Number - 380030-018

**Nut**

▼ OEM Reference

|                  |                 |                   |
|------------------|-----------------|-------------------|
| AC 4941345       | HY 2303412      | NI 43224-04H000   |
| CT 64343-19900   | KM 4941345      | TC 23654-34051    |
| HAM 4941345      | KO 300-22-31241 | TC 43224-04H000   |
| HAM 300-22-31240 | NI 40224-0T005  | TY 80942-76005-71 |
| HAM 300-22-31241 | NI 40224-FJ100  | TY 90179-14001-71 |
| HY 2021593       | NI 40224-07D0B  | YT 900126308      |



Part Number - 380030-020

**Plate**

▼ OEM Reference

HAM 4940458      HAM 3EA-15-11180A      KM 4940458  
 HAM 3EA-15-11180      HAM 3EA-15-11180L      KO 3EA-15-11180



Part Number - 380030-080

**Nut**

▼ OEM Reference  
 TY 90179-14002-71



Part Number - 380030-030

**Washer**

▼ OEM Reference

TY 43755-23440-71



Part Number - 380030-021

**Shim**

▼ OEM Reference

KM 4941505 KO 34A-24-11150  
 KM 4941506 KO 34A-24-11160



Part Number - 380030-022

**Shim**

▼ OEM Reference

AC 4941755 HAM 360-27-11220 KO 360-27-13280  
 HAM 4941755 KM 4941755 TY 90564-28002-71  
 HAM 4968320 KO 360-27-11220



Part Number - 380030-246

**Shim**

▼ OEM Reference

KO 3EB-73-A5390



Part Number - 380030-141

**Retainer**

▼ OEM Reference

NI 48594-FJ100  
 MB 91444-11300



Part Number - 380030-142

**Washer**

▼ OEM Reference

HY 300752  
 YT 505972590



Part Number - 380030-239

**Washer**

▼ OEM Reference

KO 3EB-24-A7940



Part Number - 380030-248

**Lockwasher**

▼ OEM Reference

AC CC688705  
 KO CC688705



Part Number - 380030-026

**Steer Axle Bushing**

▼ OEM Reference

HAM 4941532 HAM 34A-42-11411A KO 34A-42-11411  
 HAM 4941533 HAM 34A-42-11411L  
 HAM 34A-42-11411 KM 4941533



Part Number - 380030-155

**Steer Axle Bushing**

▼ OEM Reference

CT 91E43-05500  
 MB 91E43-05500



Part Number - 380030-049

**Steer Axle Bushing**

▼ OEM Reference

HY 2021794  
 YT 911983300



Part Number - 380030-136

**Bushing**

▼ OEM Reference

NI 49534-FJ101



Part Number - 380030-206

**Bushing**

▼ OEM Reference

KO 3EB-24-A7910



Part Number - 380030-243

**Mast Bushing**

▼ OEM Reference

KO 3EA-71-31291



Part Number - 380030-087

**Collar**

▼ OEM Reference

TY 43735-13310-71



Part Number - 380030-097

**Collar**

▼ OEM Reference

TY 43735-23440-71



Part Number - 380030-241

**Spacer**

▼ OEM Reference

HY 366115  
 YT 504235278



Part Number - 380030-092

**Grease Fitting**

▼ OEM Reference  
TY 86456-76002-71



Part Number - 380102-150

**Grease Fitting**

▼ OEM Reference

|                 |                 |                |
|-----------------|-----------------|----------------|
| AC 307-807-1850 | CL 926251       | KO 4941508     |
| AC 4941508      | KM 4941508      | NI 08932-30210 |
| BR 08932-30210  | KO 307-807-1850 | TC 08932-30210 |



Part Number - 380030-027

**Valve Cover Gasket  
H20, H25 & H20II**

▼ OEM Reference  
DW D491287  
KM 4942234  
NI 13270-E3400

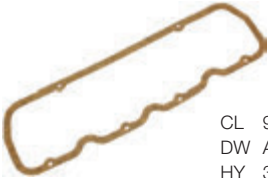

Part Number - 380030-061

**Valve Cover Gasket  
3.0L**

▼ OEM Reference  
CL 925017 TY 11214-U2120-71  
DW A218625 YT 580000617  
HY 388323

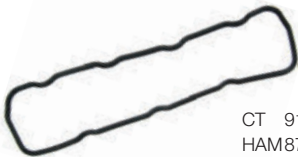

Part Number - 380030-028

**Valve Cover Gasket  
K15, K21 & K25**

▼ OEM Reference  
CT 91H20-06510 HAM13270-FY500  
HAM8772239 HAM13270-FY50A  
HAM8777419 NI 13270-FY50A



Part Number - 380030-029

**Valve Cover Gasket  
4G63 & 4G64**

▼ OEM Reference  
CL 930135  
DW A218023  
MB MD130494



Part Number - 380030-062

**Valve Cover Gasket  
FE & F2**

▼ OEM Reference  
HY 1360886  
YT 901290811



Part Number - 380030-327

**Valve Cover Gasket  
PSI 2.0 & 2.4L**

▼ OEM Reference  
HY 4111673  
YT 582041407

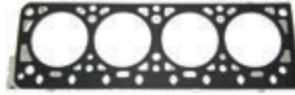

Part Number - 380030-033

**Head Gasket - For LPG Engines  
K21 & K25**

▼ OEM Reference  
CT 91H20-00370  
NI 11044-FU460

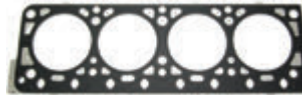

Part Number - 380030-067

▼ OEM Reference

CT 91H20-00360  
NI 11044-FU400



Part Number - 380030-227

**Head Gasket  
2.4L**

▼ OEM Reference  
HY 1584141  
YT 580056984



Part Number - 380030-034

**Manifold Gasket  
K21 & K25**

▼ OEM Reference  
CT 91H20-01740  
MB 14035-FY500



Part Number - 380106-018

**Valve Stem Seal**

▼ OEM Reference

|                |                  |                   |
|----------------|------------------|-------------------|
| CL 447597      | JU 14417150      | TY 00591-41308-81 |
| CT 14417150    | JU 14364360      | TY 00591-53754-81 |
| CT A0000-25696 | MB 14417150      | TY 00591-76787-81 |
| HY 1361718     | NI T4786-10155   | YT 76001434       |
| HY 1361719     | NI THE19-10155   | YT 901290837      |
| HY 3056228     | TC FE01-23-20010 | YT 220036489      |
| HY 76001433    | TC T4786-10155   | YT 901274801      |
| HY 76001434    | TC THE19-10155   | YT 901293847      |



Part Number - 380050-008

**O-Ring**

▼ OEM Reference

|                |                |
|----------------|----------------|
| CL 39678       | HY 39678       |
| CT 05500-31070 | MB 05500-31070 |
| HY 39677       | YT 504225236   |



Part Number - 380030-183  
**Exhaust Gasket Ring**

▼ OEM Reference  
TY 90584-43001-71



Part Number - 380050-032  
**Oil Pressure Switch**

▼ OEM Reference

|                |                |                   |
|----------------|----------------|-------------------|
| CL 920227      | KM 4920089     | TC 25240-FJ10A    |
| CL 920441      | KM 4968878     | TC T-B366-18-501  |
| CT 31A90-00300 | KO 25240-FJ10A | TY 83530-76005-71 |
| CT 90425-00390 | MB 31A90-00300 | TY 83530-78202-71 |
| CT MC840219    | MB 90425-00390 | TY 83530-U2120-71 |
| CT MD138993    | MB MC840219    | TY 83530-UC010    |
| DOS A218441    | MB MD138993    | TY 83530-UC010-71 |
| HY 1360086     | NI 25240-FJ10A | YT 901860807      |
| HY 2026608     | NI 25240-FM00A |                   |



Part Number - 380030-209  
**Oil Pressure Sensor**

▼ OEM Reference  
HY 1566654  
YT 580051890



Part Number - 380030-122  
**Valve Assembly**

▼ OEM Reference  
CT 91H20-04460  
HM 17962-FU460  
KO 8774026  
KO 17962-FU460  
NI 17962-FU460



Part Number - 380030-229  
**Intake Valve  
K21 & K25**

▼ OEM Reference  
CT 91H20-01350  
KO 13201-FY500  
MB 91H20-01350  
NI 13201-FY500



Part Number - 380030-070  
**Steering Link**

▼ OEM Reference  
TY 43751-23440-71



Part Number - 380030-071  
**Steering Link**

▼ OEM Reference  
TY 43752-23442-71



Part Number - 380030-138  
**Steering Link**

▼ OEM Reference  
CT 91B43-10500  
NI 48511-FJ101



Part Number - 380030-173  
**Steering Link**

▼ OEM Reference  
MB 93E43-00500  
NI 48512-FL100



Part Number - 380030-222  
**Steering Link (RH)**

▼ OEM Reference  
KO 3EB-25-35120



Part Number - 380030-225  
**Steering Link (LH)**

▼ OEM Reference  
KO 3EB-25-35110



Part Number - 380030-174  
**Steering Link**

▼ OEM Reference  
TY 43752-13310-71  
TY 43752-13360-71  
TY 43752-16640-71



Part Number - 380030-175  
**Steering Link**

▼ OEM Reference  
TY 43753-13311-71



Part Number - 380030-176  
**Steering Link**

▼ OEM Reference  
TY 43751-13311-71  
TY 43751-13360-71



Part Number - 380030-177  
**Steering Link**

▼ OEM Reference  
HY 381298  
YT 505972530



Part Number - 380030-156  
**Connecting Link**

▼ OEM Reference  
SY BL1034-CL



Part Number - 380030-157  
**Connecting Link**

▼ OEM Reference  
SY BL623-CL



Part Number - 380101-258

**Connecting Link**

▼ OEM Reference

|                |             |                |
|----------------|-------------|----------------|
| CT 0367163     | CT NA013216 | MB A0000-28204 |
| CT 1144528     | HY 3068751  | MB GS00-00976  |
| CT 367163      | MB 0367163  | MB NA013216    |
| CT A0000-28204 | MB 1144528  | RA 681-847     |
| CT GS00-00976  | MB 367163   |                |



Part Number - 380104-143

**Tie Rod Pin**

▼ OEM Reference

|                |                |
|----------------|----------------|
| CT 91444-10700 | MB 91444-10700 |
| CT 91A43-10700 | MB 91A43-10700 |



Part Number - 380030-036

**PCV Valve**

▼ OEM Reference

|                |                |                   |
|----------------|----------------|-------------------|
| CT 91H20-00480 | NI 11810-75T00 | TY 12204-76014-71 |
| HY 1360893     | TC 212T1-09141 | YT 901290819      |



Part Number - 380030-121

**Tie Rod End**

▼ OEM Reference

|              |
|--------------|
| HY 185870    |
| YT 504224200 |
| YT 504224219 |



Part Number - 380104-091

**PCV Valve**

▼ OEM Reference

|            |              |
|------------|--------------|
| HY 1553692 | YT 580046873 |
| YT 1553692 |              |



Part Number - 380030-078

**Tie Rod End**

▼ OEM Reference

|                |
|----------------|
| NI 48520-10H04 |
|----------------|



Part Number - 380030-040

**Crankshaft Sensor**

▼ OEM Reference

|                |
|----------------|
| NI 23731-6J906 |
|----------------|



Part Number - 380030-178

**Tie Rod End**

▼ OEM Reference

|                |
|----------------|
| NI 48520-00H04 |
|----------------|



Part Number - 380104-928

**Camshaft Sensor**

▼ OEM Reference

|                |                |                |
|----------------|----------------|----------------|
| CT 91H20-21170 | KO 8779379     | KO 23731-6N21A |
| KO 23731-6N20C | KO 8780027     | NI B3731-6N20C |
| KO 8772279     | KO B3731-6N20C |                |



Part Number - 380030-217

**Tie Rod End**

▼ OEM Reference

|                 |
|-----------------|
| KO 3EB-24-A7920 |
|-----------------|

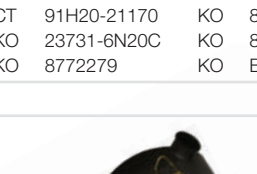

Part Number - 380030-291

**Cap - Sub-Assembly - Air**

▼ OEM Reference

|                   |
|-------------------|
| TY 17704-U2230-71 |
|-------------------|



Part Number - 380030-218

**Tie Rod End**

▼ OEM Reference

|                 |
|-----------------|
| KO 3EB-24-A7930 |
|-----------------|



Part Number - 380030-140

**Tie Rod Pin**

▼ OEM Reference

|                |
|----------------|
| NI 48513-FJ100 |
| NI 48513-FJ10B |



Part Number - 380030-041

**Oxygen Sensor**

▼ OEM Reference

|                |
|----------------|
| CT 91A62-03500 |
| NI 22690-FU460 |



Part Number - 380030-224

**Tie Rod Pin**

▼ OEM Reference

|                 |
|-----------------|
| KO 3EB-24-51281 |
| KO 3EB-25-A7171 |



Part Number - 380030-171

**Oxygen Sensor**

▼ OEM Reference

|                   |
|-------------------|
| TY 17410-26600-71 |
|-------------------|





Part Number - 380030-219

**Oxygen Sensor**

▼ OEM Reference

|    |             |    |             |    |           |
|----|-------------|----|-------------|----|-----------|
| CT | 93721-06600 | HY | 1646456     | YT | 580076752 |
| HN | E1799102    | MB | 93721-06600 |    |           |



Part Number - 380030-082

**Solenoid**

▼ OEM Reference  
TA 72-501-43



Part Number - 380030-247

**Oxygen Sensor**

▼ OEM Reference

CT 91165-15900  
MB 91165-15900



Part Number - 380030-083

**Hose - sheave**

▼ OEM Reference  
HY 1494017



Part Number - 380030-215

**Map Sensor**

▼ OEM Reference  
NI 22680-FU460



Part Number - 380030-201

**Hose - sheave**

▼ OEM Reference  
HY 1343989  
YT 504064782



Part Number - 380030-232

**Map Booster Sensor**

▼ OEM Reference  
HY 1548352  
YT 580045523



Part Number - 380030-290

**Hose - sheave**  
**4.3999" OD x .7490"**

▼ OEM Reference  
CL 448821 MB A0000-10938 TY 68855-25150-71  
CT A0000-10938 TY 00591-72014-81 YT 220022101  
HY 3127445 TY 68804-25080-71



Part Number - 380030-330

**Sensor - Temperature Coolant**

▼ OEM Reference  
HY 1515654  
YT 580036023



Part Number - 380030-118

**Plug**

▼ OEM Reference  
HY 109169 KO 07046-13520 YT 012156900  
HY 1194451 NI 00933-33500  
KM 4940295 TY 80330-76010-71



Part Number - 380030-054

**Hub Cap**

▼ OEM Reference  
KM 8772430  
KO 3EB-24-11160



Part Number - 380030-148

**Plug**

▼ OEM Reference  
KO 07046-14020  
YT 959100911



Part Number - 380102-318

**Hub Cap**

▼ OEM Reference  
HY 2021800 YT 900003100  
JU 14101710 YT 922363300  
JU 14474150



Part Number - 380030-170

**Plug**

▼ OEM Reference  
HY 185860  
YT 504224266



Part Number - 380030-056

**Hood Hinge**

▼ OEM Reference  
KO 3EB-50-31271



Part Number - 380030-072

**Clutch Cover**

- ▼ OEM Reference
- KO 3EB-10-11510
- KO 3EA-10-14130
- KO 3EB-10-21610
- CT 91221-05010



Part Number - 380030-200

**Horn (12 Volt)**

- ▼ OEM Reference
- NI 25620-GH10A



Part Number - 380030-147

**Muffler Cushion**

- ▼ OEM Reference
- KO 3EB-03-31140
- NI 20638-61500
- TC 22252-32241A



Part Number - 380030-032

**Horn Kit Cup**

- ▼ OEM Reference
- TY 45122-23600-71



Part Number - 380030-112

**Gas Spring**

- ▼ OEM Reference
- CT 91312-02900
- MB 93113-09600
- NI 65320-FB401



Part Number - 380030-106

**Horn Button**

- ▼ OEM Reference
- TY 45121-U2100-71



Part Number - 380030-159

**Gas Spring**

- ▼ OEM Reference
- AC 4966556
- HAM3EB-50-A5110
- HAM3EB-50-A5111
- HAM8761692
- HAM8772331
- HM 3EB-50-A5111
- KM 8761692
- KO 3EB-50-A5111



Part Number - 380030-208

**Horn Button**

- ▼ OEM Reference
- NI 48422-GD80A



Part Number - 380102-254

**Horn Button**

- ▼ OEM Reference
- TY 45121-12471-71
- TY 45121-12472-71



Part Number - 380030-199

**Gas Spring**

- ▼ OEM Reference
- HY 1563497
- YT 580056664



Part Number - 380030-325

**Horn Button**

- ▼ OEM Reference
- HY 1347135



Part Number - 380030-210

**Gas Spring**

- ▼ OEM Reference
- KO 3EB-50-41150



Part Number - 380030-213

**Horn Pad**

- ▼ OEM Reference
- KO 3EB-33-41130



Part Number - 380030-337

**Gas Spring, Hood Cover (LH)**

- ▼ OEM Reference
- HY 4011435
- YT 582004571



Part Number - 380030-223

**Horn Cover**

- ▼ OEM Reference
- KO 3EB-33-31240



Part Number - 380030-113

**Horn (12 Volt)**

- ▼ OEM Reference
- KO 3EB-55-23511
- HM 12-720



Part Number - 380030-326

**Contact Set, Horn**

- ▼ OEM Reference
- YT 580049812



Part Number - 380030-275

**Hose - Oil Cooler**

▼ OEM Reference  
TY 32999-23330-71



Part Number - 380030-284

**Sensor, Accelerator**

▼ OEM Reference  
TY 57510-26600-71



Part Number - 380030-094

**Plate, Steer Axle**

▼ OEM Reference  
TY 43237-13310-71



Part Number - 380051-004

**Stop Light Switch**

▼ OEM Reference  
KM 34B-55-15230  
KM 4941704  
KO 34B-55-15230



Part Number - 380030-107

**Ignition Module**

▼ OEM Reference  
HY 1326536  
KM 4968820  
NI 22020-G5111  
YT 901953809

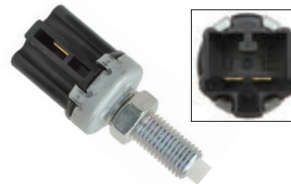

Part Number - 380051-005

**Stop Lamp Switch**

▼ OEM Reference  
NI 25320-GB000



Part Number - 380030-153

**Bracket/Guard**

▼ OEM Reference  
HY 1354105  
YT 580000118



Part Number - 380051-006

**Directional Switch**

▼ OEM Reference  
CT 91A05-75020  
MB 91A05-75020  
NI 25560-FK20A



Part Number - 380030-204

**Bracket/Guard**

▼ OEM Reference  
NI 26311-FB00A  
NI 26311-FV00A



Part Number - 380030-322

**Switch Assembly, Directional Control**

▼ OEM Reference  
TY 57460-26631-71



Part Number - 380030-181

**Battery Terminals (Top)**

▼ OEM Reference  
HM 53710



Part Number - 380030-323

**Switch Assembly, Directional Control**

▼ OEM Reference  
TY 57460-23331-71



Part Number - 380030-207

**Relay**

▼ OEM Reference  
CT 91A04-11700  
KO 3EB-55-41450  
MB 91A04-11700  
NI 25230-GE00A



Part Number - 380030-261

**Directional Switch**

▼ OEM Reference  
CT A0000-14969  
MB A0000-14969  
TY 57460-23330-71



Part Number - 380051-003

**Brake Switch**

▼ OEM Reference  
HY 2077505  
YT 524228854



Part Number - 380051-008  
**Turn Signal Switch**

- ▼ OEM Reference
- CT 91A05-13400
- MB 91A05-13400
- NI 25541-FK000



Part Number - 380030-231  
**Knuckle (RH)**

- ▼ OEM Reference
- AC 3EB-24-51212
- KO 3EB-24-53212



Part Number - 380105-520  
**Switch, Forward/Reverse**

- ▼ OEM Reference
- CT 91306-45200
- CT 91406-42800
- CT 97C41-21900
- CT 97C41-31500
- MB 91306-45200
- MB 91406-42800
- MB 97C41-21900
- MB 97C41-31500



Part Number - 380102-814  
**Knuckle (LH)**

- ▼ OEM Reference
- TY 43212-23470-71
- TY 43212-23471-71



Part Number - 380030-072  
**Clutch Cover**

- ▼ OEM Reference
- KO 3EB-10-11510
- KO 3EA-10-14130
- KO 3EB-10-21610
- CT 91221-05010



Part Number - 380102-835  
**Knuckle (RH)**

- ▼ OEM Reference
- CL 449310
- CT A000025847
- MB A000025847
- TY 43211-13311-71
- TY 43211-13312-71
- TY 43211-23470-71
- TY 43211-23471-71
- TY 43211-F1101-71
- TY 43211-F1102-71
- TY 43251-F1100-71



Part Number - 380030-282  
**Relay**

- ▼ OEM Reference
- ND 056800-2440-RPL
- ND 587005370
- TY 57410-30530-71



Part Number - 380102-821  
**Knuckle (RH)**

- ▼ OEM Reference
- HY 1464149
- YT 580011755



Part Number - 380030-216  
**V Belt Tensioner**

- ▼ OEM Reference
- HY 2067631
- HY 2090303
- HY 4019125
- YT 580048921
- YT 580073942
- YT 582007582

HY 2067631  
HY 2090303

HY 4019125  
YT 580048921

YT 580073942  
YT 582007582



Part Number - 380030-233  
**Panel Assembly**

- ▼ OEM Reference
- NI 65261-FK102



Front \ Back view

Part Number - 380001-025  
**Tensioner Pulley**

- ▼ OEM Reference
- HY 2029098



Part Number - 380030-240  
**Insulator**

- ▼ OEM Reference
- KO 3EB-33-31160



Part Number - 380030-221  
**Knuckle (LH)**

- ▼ OEM Reference
- KO 3EB-24-51222
- KO 3EB-24-53222



Part Number - 380030-245  
**Hydraulic Filter**

- ▼ OEM Reference
- TY 67502-26600-71
- TY 67502-U2230-71

## Miscellaneous



Part Number - 380030-274

### Dipstick

▼ OEM Reference  
TY 32604-26610-71



Part Number - 380030-194

### Post, Overhead Guard (LH, Rear)

▼ OEM Reference  
NI 73761-FW70A



Part Number - 380030-338

### Reservoir Cap

▼ OEM Reference

|            |                   |                   |
|------------|-------------------|-------------------|
| CT 217218  | MB 217218         | TY 47230-76001-71 |
| HY 3041805 | TY 00591-71425-81 | YT 220011562      |
| HY 3061805 | TY 47230-20030-71 |                   |



Part Number - 380030-195

### Post, Overhead Guard (RH, Rear)

▼ OEM Reference  
NI 73760-FW70A



Part Number - 380100-011

### Accelerator Cable

▼ OEM Reference

|                 |                   |                   |
|-----------------|-------------------|-------------------|
| BK LA1003837001 | JU 144150208      | TY 00591-55813-81 |
| CL 7001112      | LI LA1003837001   | TY 00591-55825-81 |
| CT 14415020     | MB 14415020       | YT 144150208      |
| CT A0000-10391  | MB A0000-10391    | YT 220037736      |
| HY 2021429      | TY 00591-22441-81 | YT 911851401      |
| HY 3057736      | TY 00591-30313-81 | YT 911851402      |
| HY 3065605      | TY 00591-35479-81 | YT 919512401      |
| HY 3065807      | TY 00591-53465-81 |                   |
| JU 14415020     | TY 00591-55812-81 |                   |

See  
Section  
11

# 3 Ways to Save with Pre-Assembled Wheels from Crown.

**100**  
SERIES  
Light Duty

**200**  
SERIES  
Midrange

**300**  
SERIES  
High Capacity

**400**  
SERIES  
Heavy Duty

- 1 Lower Maintenance Labor Cost
- 2 Minimize Operator Downtime
- 3 Reduce Parts Inventory



# Crown Tool Program

Tools designed and built to get the job done!



The Crown tool program offers high quality tools selected specifically for technicians to handle most lift truck repairs. Each item offered is individually labeled with the Crown logo and the part number. Most tools include a lifetime warranty.



See the Tools section for the assortment of tools available.

## Section 6

# Work Assist<sup>®</sup>

### Contents

|   |      |
|---|------|
| Work Assist <sup>®</sup> Accessories<br>Application Chart | 6.02 |
| Work Assist <sup>®</sup> Accessories                      | 6.03 |
| RAM Mounts  | 6.09 |
| Camera Systems  | 6.13 |
| Fork Level Indicator                                      | 6.15 |
| Fork Laser Guidance System                                | 6.15 |
| Forklift Covers & Enclosures                              | 6.18 |

Note: 1910.178(q)(5) (1998) of the Occupational Safety and Health Act (OSHA) requires that "All parts of any such industrial truck requiring replacement shall be replaced only by parts equivalent as to safety with those used in the original design."





# Work Assist<sup>®</sup>

## Accessories & Options

Crown knows a clean, organized work environment means increased operator productivity. That's why Crown offers **Integrated Truck Solutions** that are designed to make the operator's job faster, easier, and more productive.



Clip Pad



Clip Pad and Hook



Shrink Wrap Holder



Storage Pocket



Shrink Wrap Tray



Cup Holder



Storage Net



WORK ASSIST<sup>®</sup>

| Work Assist Accessories & Options*                   | Aftermarket Kit Numbers | RC | SC | FC | SP | RM | RR | RD | PE | PR | C-5** |
|--|-------------------------|----|----|----|----|----|----|----|----|----|-------|
| Accessory Clamp (Includes Hardware)                  | 130145                  | •  | •  | •  | •  | •  | •  | •  | •  | •  | •     |
| Shrink Wrap Holder (Includes Clamps & Hardware)      | 145080                  | •  | •  | •  | •  | •  | •  | •  | •  | •  | •     |
| Hook (Includes Clamp & Hardware)                     | 131419                  | •  | •  | •  | •  | •  | •  | •  | •  | •  | •     |
| Clip Pad and Hook (Includes Clamp & Hardware)        | 130144                  | •  | •  | •  | •  | •  | •  | •  | •  | •  | •     |
| Clip Pad (Includes Clamp & Hardware)                 | 131415                  | •  | •  | •  | •  | •  | •  | •  | •  | •  | •     |
| Cup Holder (Includes Clamp & Hardware)               | 145078                  | •  | •  | •  | •  | •  | •  | •  | •  | •  | •     |
| Storage Pocket (Includes Clamp & Hardware)           | 130868                  | •  | •  | •  | •  | •  | •  | •  | •  | •  | •     |
| Shrink-Wrap Tray                                     | 131379                  | na | na | na | na | na | na | na | •  | •  | na    |
| Storage Net Behind Seat                              | 147005S                 | na | na | na | na | na | na | na | na | na | •     |
| PE/PR - Accessory Pole (Includes Hardware)           | 131380                  |    |    |    |    |    |    |    |    |    |       |
| PE/PR - Accessory Pole Extension (Includes Hardware) | 131381                  |    |    |    |    |    |    |    |    |    |       |
| SP - Accessory Pole (Includes Hardware)              | 130879                  |    |    |    |    |    |    |    |    |    |       |
| RR/RD - Accessory Pole (Includes Clamp & Hardware)   | 131416                  |    |    |    |    |    |    |    |    |    |       |
| RR/RD - Accessory Pole (Includes Bracket & Hardware) | 131414                  |    |    |    |    |    |    |    |    |    |       |
| RC - Accessory Pole (88.0" OHG)                      | 141296-002              |    |    |    |    |    |    |    |    |    |       |
| RC - Accessory Pole (84.5" OHG)                      | 141296-001              |    |    |    |    |    |    |    |    |    |       |

\* Some products may require the use of a Work Assist accessories pole for the installation of Crown's Work Assist Options.

\*\* C-5 Cushion products only.



# Mounting

## Tubes

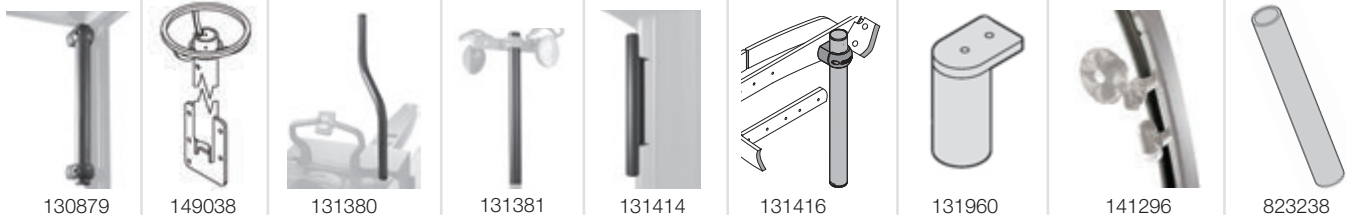

| Part No. | Description   | Model               |
|----------|---|---------------------|
| 130879   | Accessory Rail Kit LH or RH   | SP 3000 Series      |
| 149038   | Work Assist Pole  | PC 4500             |
| 131380   | Standard Work Assist Tube Kit   | PE 4000 Series      |
| 131381   | Work Assist Tube Extension Kit  | PE/PR 4000 Series   |
| 143680   | Standard Work Assist Tube Kit;<br>Note: Electrical kit is P.N. 143681 | PR 4500             |
| 131414   | Right Tube Assembly Kit   | RR/RD 5000/S Series |

| Part No.   | Description                | Model               |
|------------|----------------------------|---------------------|
| 131416     | Work Assist Tube Kit       | RR/RD 5000/S Series |
| 131960-001 | TT Mast                    | ST/SX 3000          |
| 131960-002 | TL Mast                    | ST/SX 3000          |
| 141296-001 | 84.5" Work Assist Tube Kit | RC 5500             |
| 141296-002 | 88" Work Assist Tube Kit   | RC 5500             |
| 823238     | Work Assist Tube Kit       | SR 5200             |

Note: Plug for tubes is P.N. 124530

⚠WARNING: Cancer and reproductive harm - [www.P65Warnings.ca.gov](http://www.P65Warnings.ca.gov)

143840-XXX

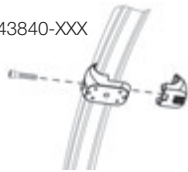

## Clamp

### Part Number

|            |  |
|------------|--|
| 130145     | Clamp                                      |
| 143840-001 | Used on C5 Pneumatic, 45° angle            |
| 143840-002 | Used on C5 Pneumatic, in line w/truck mtg  |
| 153181S    | Clamp Kit; Used on FC4500                  |
| 330146     | CG CD Clamp Kit; Used on CG / CD front OHG |



130145

## Work Assist® Interface with RAM Mounting System



The Crown Ball Mount design (P.N. 351094-XXX) allows you to add the RAM mounting system to the Crown Work Assist® clamps and accessories. The addition of the RAM mounting system allows you to position your accessories for the best access and prevent damage due to shock and vibration. See RAM mount pages 6.09-6.12.

WORK ASSIST®

## Terminal Mounting Plates



| Part No.   | Description                       | Model   |
|------------|-----------------------------------|---|
| 126236-001 | Mounting Bracket LXE              | RR/RD 5000/S Series   |
| 126236-002 | Mounting Bracket Norand           | RR/RD 5000/S Series   |
| 126236-003 | Mounting Bracket Telxon           | RR/RD 5000/S Series   |
| 129572     | Adjustable Bar & Mounting Bracket | RR/RD 5000/S Series   |
| 130146*    | Mounting Plate                    | FC4000 Series, SC4000/5000 Series, SP3000/4000 Series, PE/PR4000 Series, RR/RD5000 Series, C5, TSP6000 /7000 Series |

| Part No. | Description                     | Model  |
|----------|---------------------------------|--|
| 131417*  | Universal Mounting Plate        | C5 Cushion, FC 4000 Series, SC 4000 Series, RC 3000/RC 5500, RM/RMD 6000/S, SP 3000 Series, PE/PR 4000 Series, RR/RD 5000/S Series/ TSP 6000/7000 Series |
| 131418*  | Mounting Bracket                | C5 Cushion, FC 4000 Series, SC 4000 Series, RC 3000/RC 5500, RM/RMD 6000/S, SP 3000 Series, PE/PR 4000 Series, RR/RD 5000/S Series, TSP 6000/7000 Series |
| 148748*  | Universal Terminal Mounting Kit | C5 Cushion, FC 4000 Series, SC 4000 Series, RC 3000/RC 5500, RM/RMD 6000/S, SP 3000 Series, PE/PR 4000 Series, RR/RD 5000/S Series/ TSP 6000/7000 Series |
| 814715   | Bracket Data Log                | ESR 4500/5000  |

\*Works with Crown RAM; includes clamps; hardware needed

Note: Optional recommended ball mount size: 2.25" - P.N. 160809

## Clip Pads



### Clip Pad

#### Part Number

|        |                     |
|--------|---------------------|
| 131415 | Includes clamp      |
| 141462 | Used on SH/SHR 5500 |
| 151743 | Used on WP 3000     |

Note: Optional recommended ball mount size: 2.25" - P.N. 160809



### Clip Pad and Hook

#### Part Number

|        |  |
|--------|--|
| 130144 | Includes clamp                                 |
| 141460 | No clamp; includes plate to use on SH/SHR 5500 |

Note: Optional recommended ball mount size: 2.25" - P.N. 160809



#### Part Number

|            |                |
|------------|----------------|
| 816658     | Housing        |
| 814594     | Spring         |
| 060062-003 | Screw (qty. 2) |

Used on RC 5500

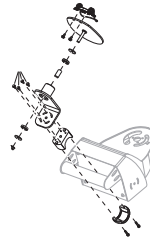

### Clip Pad, Clamp-On

#### Part Number

146238

Used on PC 4500, E-Steer.

Note: Optional recommended ball mount size: 2.25" - P.N. 160809

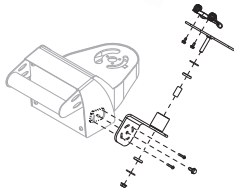

### Clip Pad, Bolt-On

#### Part Number

146237

Used on PC 4500, E-Steer.

## Storage

Continued ▶

### Storage Organizer Kit Components



162915



162913



162912



162914



162920



154662



163561-001

### Organizer Kits with Bracket

#### Kit Components

| Part Number | Description            | Bin Divider (162914) | Small Pocket (162913) | Large Pocket (162912) |
|-------------|------------------------|----------------------|-----------------------|-----------------------|
| 163561-003  | Mixed Pocket Organizer |                      | 2                     | 2                     |
| 163561-001  | Large Pocket Organizer |                      |                       | 3                     |
| 163561-002  | Small Pocket Organizer |                      | 6                     |                       |
| 163561-004  | ClipBoard Organizer    | 1                    | 3                     |                       |

Includes: Bin (162915), Work Assist Clamp (130145), Bin Bracket (162920), and Hardware.



163506-002

### Organizer Kits with Magnets

#### Kit Components

| Part Number | Kit Description        | Bin Divider (162914) | Small Pocket (162913) | Large Pocket (162912) |
|-------------|------------------------|----------------------|-----------------------|-----------------------|
| 163506-002  | Three Pocket Organizer |                      |                       | 3                     |
| 163506-003  | ClipBoard Organizer    | 1                    | 3                     |                       |
| 163506-004  | One Pocket Organizer   |                      |                       | 1                     |
| 163506-001  | Organizer              | 1                    |                       |                       |

Includes: Bin (162915), Magnets (154662) and Hardware.



163490-003

### Single Pocket Organizer Kits

#### Kit Components

| Part Number | Kit Description    | Small Pocket (162913) | Large Pocket (162912) | Work Assist Clamp (130145) | Peanut Clamp (143840-001) | Pocket Mount (141752) | Small Pocket Bracket (163489) | Large Pocket Bracket (163488) |
|-------------|--------------------|-----------------------|-----------------------|----------------------------|---------------------------|-----------------------|-------------------------------|-------------------------------|
| 163490-004  | Small Pocket Clamp | •                     |                       | •                          |                           | •                     | •                             |                               |
| 163490-003  | Large Pocket Clamp |                       | •                     | •                          |                           | •                     |                               | •                             |
| 163490-001* | Large Pocket P-Nut |                       | •                     |                            | •                         | •                     |                               | •                             |
| 163490-002* | Small Pocket P-Nut | •                     |                       |                            | •                         | •                     | •                             |                               |

\* Used on SC6000 Truck Models. Includes: Hardware.

## Storage



### Pocket

#### Part Number

|            |                                    |
|------------|------------------------------------|
| 130868     | Orange; includes clamp             |
| 125997-001 | Orange; used on Wave; 1 pocket kit |
| 125997-002 | Orange; used on Wave; 2 pocket kit |
| 141461     | Orange; used on SH/SHR 5500 kit    |
| 151744     | Orange; used on WP 3000            |
| 141751     | Orange pocket only                 |

Note: Optional recommended ball mount size: 1" - P.N. 351094-001



### Storage Tray Upper & Lower Kits

#### Part Number

|         |                    |
|---------|--------------------|
| 141228S | Upper Storage Tray |
| 141229S | Lower Storage Tray |

### Storage Module - Battery Cover Mount

#### Part Number

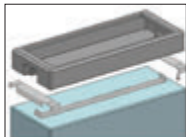

|        |   |
|--------|---|
| 115870 | Tray only   |
| 117420 | Used on trucks with no load backrest; includes one long bracket; designed to be removable |
| 141042 | Used on trucks with no load backrest; includes two side brackets; designed to be fixed    |

### Storage Module - Battery Cover Mount

#### Part Number



|        |                                 |
|--------|---------------------------------|
| 137513 | Mounts to bolt-on load backrest |
| 137514 | Mounts to hinged load backrest  |



### Storage Net Behind Seat

#### Part Number

|                        |
|------------------------|
| 147005S                |
| Also order:            |
| - 4 inserts 060103-006 |
| - 4 screws 060062-041  |
| - 4 wall hooks 147008  |



### Storage Net

#### Part Number

|                                       |                                   |
|---------------------------------------|-----------------------------------|
| 147004                                | Used on FC 4500, SC 6000, SC 5200 |
| Requires four 153181S clamps to mount |                                   |



### Storage Tray

#### Part Number

|            |   |
|------------|---|
| 129988     | Used on trucks with Flex Seat - FC 4000 series, SC 4000 series  |
| 129988-002 | Used on trucks with Suspension Seat - FC 4500, SC 4500, SC 5200 |



### Storage Bin Kit

#### Part Number

|                |  |
|----------------|--|
| 157732         | Includes 2 bins, 2 brackets, 2 double-sided tape squares, 2 bungees. |
| Used on PTH50. |  |

### Storage Module, Magnetic Mount

#### Part Number



|   |
|---|
| 144441S   |
| Includes tray, magnet and hardware. Can put two together and put on pallet truck battery cover. Used on PC 4500, TR 4500. |

#### Part No.

|        |                    |
|--------|--------------------|
| 132715 | Replacement Magnet |
|--------|--------------------|

## Now Available:



Please Wait Here Floor Sign  
See Page 3.09



Mast Blocking Kits  
See Page 9.21



Disinfectant Spray Q  
See Page 1.08



## Shrink Wrap Accessories



### Shrink Wrap Tray

Part Number

131379

Used on PE 4000 Series, PW 3500, PR 4500



### Shrink Wrap Holder Kit - Mounts on Pole

Part Number      Model

|         |         |
|---------|---------|
| 145080  | PC 4500 |
| 147205S | SC 5200 |

Note: Optional recommended ball mount size: 2.25" - P.N. 160809



### RC5500 Shrink Wrap Holder Kit

Part Number

H53382-501

Used with Shrink Wrap Stick, 300150

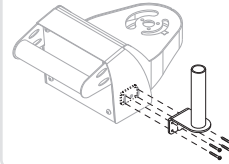

### Shrink Wrap Holder, Bolt-On

Part Number

145081

Used on PC 4500, E-Steer



### Shrink Wrap Stick

Part Number

300150

Strong construction built to last in the most demanding applications. Quick change of stretch rolls with quarter-turn bottom loading mechanism. Automatic Tensioning System allows user to determine tension preference. Allows users to stand and walk forward while wrapping a pallet.

See shrink wrap on page 1.22

## Holders & Hooks



### Cup Holder, Clamp-On

Part Number

145078

Used on PC 4500 E-Steer, FC 4000 Series, SC 4000 & 5000 Series, C5

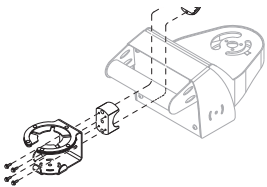

Note: Optional recommended ball mount size: 1.5" - P.N. 157749



### Hook

Part Number

|        |  |
|--------|--|
| 131419 | For use with RF, includes clamp                            |
| 141463 | Does not include clamp, includes plate used on SH/SHR 5500 |

Note: Optional recommended ball mount size: 1.5" - P.N. 157749



### Utility Hook

Part Number

131036

Note: Includes two hooks and warning labels.

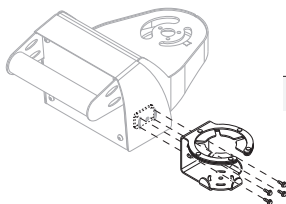

### Cup Holder, Bolt-On

Part Number

145079

Used on PC 4500, E-Steer.

## Fire Extinguishers

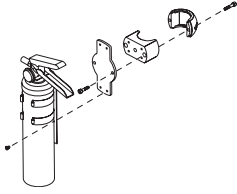

### Fire Extinguisher Kit

#### Part Number

141187

Includes fire extinguisher. Used on SC 4000/5000 Series, FC 4000 Series, C5 & RC 5500

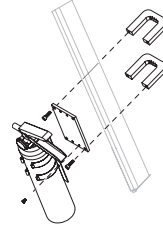

### Fire Extinguisher Kit - Drive Thru Rack

#### Part Number

127591

Includes fire extinguisher. Used on FC 4000 Series & SC 4000/5000 Series

**Note:** U-clamps only, 127419

## Fans



131388 (PE 4000)



140083 (RC 5500)

### Fan Kits

| Part Number | Type                                | Model                                 |
|-------------|-------------------------------------|---------------------------------------|
| 131388*     | 24V                                 | PE 4000                               |
| 140125*     | 24V                                 | PE 4500, PR 4500                      |
| 132781-002  | 24V                                 | ST/SX 3000 (Mounted on work platform) |
| 141459      | 24V                                 | SH/SHR 5500                           |
| 127503-001  | 36V                                 | FC 4000 Series, SC 4000 Series        |
| 140083      | 36V                                 | RC 5500                               |
| 150226      | 36V                                 | RM/RD 6000/S                          |
| 127592-001  | 36V, Fits Drive Thru Overhead Guard | FC 4000, SC 4000 Series               |
| 127592-002  | 48V, Fits Drive Thru Overhead Guard | FC 4000 Series                        |
| 127503-002  | 48V                                 | FC 4000 Series                        |

\*Harness sold separately. Order Work Assist Electrical Kit, P.N. 140132.

**Note:** Optional recommended ball mount size: 1.5" - P.N. 157749

**WARNING:** Cancer and reproductive harm - [www.P65Warnings.ca.gov](http://www.P65Warnings.ca.gov)

### Fan Only

| Part Number | Type               | Model                                   |
|-------------|--------------------|---|
| 127259-010  | 12V with switch    | C5                                      |
| 127259-007  | 24V with switch    | PE 4000 Series, ST/SX 3000, RR 5200     |
| 125755      | 24V with switch    | RC 3000                                 |
| 127259-004  | 24V without switch | PE 4000 Series                          |
| 127259-002  | 36V with switch    | SC 4000 Series, FC 4000 Series, RR 5200 |
| 127259-005  | 36V without switch | FC 4000 Series, SC 4000 Series, RC 5500 |
| 127259-003  | 48V with switch    | FC 4000, TSP 6000                       |
| 127259-006  | 48V without switch | FC 4000 Series, TSP 6000                |

### Fan & Worklight Kit

|        |                    |                    |
|--------|--------------------|--------------------|
| 140127 | 24V without switch | PE 4500AC, PR 4500 |
|--------|--------------------|--------------------|

## Lights



### Strobe Light Kit

#### Part Number Color

|            |       |
|------------|-------|
| 131377-001 | Amber |
| 131377-002 | Red   |
| 131377-003 | Blue  |



### Flashing Light Kit

#### Part Number

131378



131376 (PE 4000)

### Front Worklight Kits

| Part Number | Description                     | Model             |
|-------------|---------------------------------|-------------------|
| 128921      | Drive Thru Overhead Guard       | FC 4000 Series    |
| 129589      | Standard Overhead Guard Mounted | FC 4000 Series    |
| 127528-001  | Drive Thru Overhead Guard       | SC 4000           |
| 127532-001  | Standard Overhead Guard Mounted | SC 4000 Series    |
| *131376     | Mounted on Work Assist Pole     | PE 4000 Series    |
| 140126      | Mounted on Work Assist Pole     | PR 4500 & PE 4500 |
| 133896-002  | Mounted on Work Assist Pole     | ST/SX 3000        |

\*Does not include mounting brackets



### Dome Light

#### Part Number

123683

Used on RM/RMD 6000/S, RC 5500. Will also need to order plate 139555, 2 of 060030-010, 2 of 060059-034, 2 of 060061-038, 2 of 060062-027 and clamp 130145.

## Platforms



### Work Platform

#### Part Number

133892S

Accessories:  
Work Platform Tray  
(P.N. 133894)  
Used on ST/SX 3000



### Snap-On Platform

#### Part Number W x L (in)

|            |            |
|------------|------------|
| 131069-001 | 25 x 36.50 |
| 131069-002 | 25 x 42.50 |
| 131069-003 | 25 x 48.50 |

Used on ST/SX 3000



### Remote

#### Part

| Number     | Mast Type                   | Application |
|------------|-----------------------------|-------------|
| 132782-002 | ST/SX 3000, TL              | Ground      |
| 132782-003 | ST/SX 3000, TT              | Ground      |
| 133895-002 | ST 3000, TL Mast            | Platform    |
| 133895-003 | ST 3000, Sideshift, TL Mast | Platform    |
| 133895-004 | SX 3000, TL Mast            | Platform    |
| 133895-005 | ST 3000, TT Mast            | Platform    |
| 133895-006 | ST 3000, Sideshift, TT Mast | Platform    |
| 133895-007 | SX 3000, TT Mast            | Platform    |

## Miscellaneous



### Programmable Security Lock

This keypad offers an enhanced level of security to deter unauthorized or untrained personnel from operating the vehicle. A four digit Personal Identification Number can be assigned for up to 200 operators that use the vehicle. Supervisor can "lockout" vehicle through keypad and can program keypad to turn vehicle "OFF" automatically if vehicle is idle for prolonged periods.

Power input is 15 amps externally fused, 48 volts maximum. Power output is 10 amps maximum. Operating temperature range is -40 to +85° Celsius.

| Part Number | Used on                         | Kit Instructions |
|-------------|---------------------------------|------------------|
| 130863-001  | Wave                            |                  |
| 130863-002  | RC3, FC4, Turrett, SP48, SP3000 |                  |
| 130863-003  | WP2300                          | PF26004          |
| 130863-003  | WP3000                          | PF26265          |

### Kit Instructions for Programming

|         |                  |
|---------|------------------|
| PF11830 | Dealer Level     |
| PF11831 | Manager Level    |
| PF11832 | Supervisor Level |



### Bracket Assembly for Mirror, Rear View

#### Part Number

134212

Note: Used on TSP 6000/7000, SP 4000

Order Separately  
- Clamp 130145  
- Screw 060061-022 (Qty.4)  
- Mirror 137670



### Tool Retractor

#### Part Number

300114

Capacity 1.76-4.4 lbs. (0.8-2.0kg)  
Extended rope length - 5.5 ft.



### Pick Assist Tool

#### Part Number

351099

The pick assist tool has a lightweight design and a telescoping feature that will effortlessly extend the reach of the order picking staff. It has a collapsed length of 28" and can be extended to 41". This versatility allows the stick to be set into place at any length desired by the order picker to ensure maximum effectiveness.

### Pick Assist Mounting Kit

#### Part Number

351100

This kit is for the SP only.



### Mirror Kit

#### Part

| Number     | Series                          | Description |
|------------|---------------------------------|-------------|
| 130673     | C5, FC4000/4500 & SC4000/45000  | Glass       |
| 150511S001 | SC5200, standard overhead guard | Glass       |
| 150511S002 | SC5200, standard overhead guard | Plastic     |

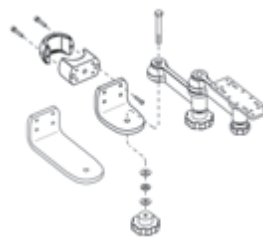

### Adjustable Arm System Kit

#### Part Number

136994

Note: Used on TSP 6000/7000 & SR

## RAM Mounts

Protect your electronic devices by using the RAM Mounting System. RAM mounts utilize a patented rubber ball and socket design which isolates and dampens shock and vibration up to 50G of shock. Adjustable positioning features can not be matched by another mounting method. Mounting bases quickly attach and fit every OEM lift cage or overhead guard made. All backed by a lifetime manufacturer's warranty. Made in USA.

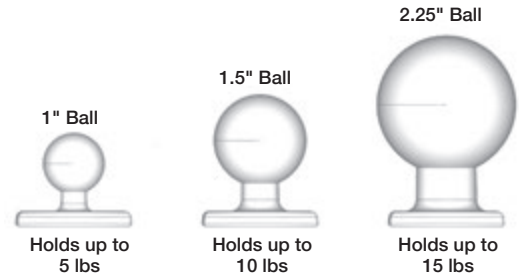

### How to Order:

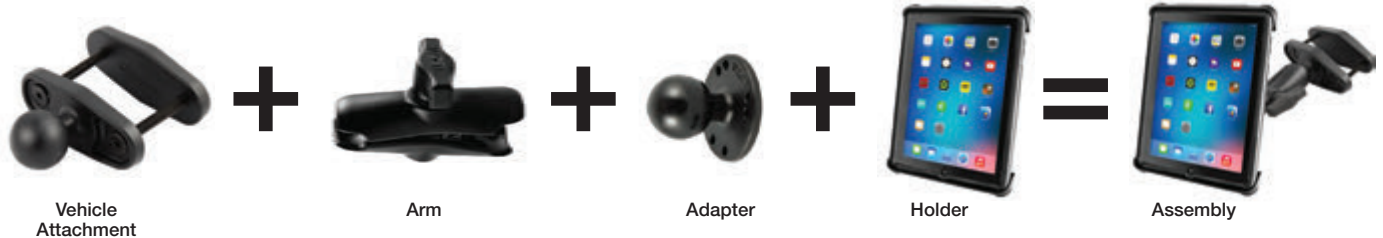

### Work Assist® Interface with RAM Mounting System



The Crown Ball Mount design (P.N. 351094-XXX) allows you to add the RAM mounting system to the Crown Work Assist® clamps and accessories. The addition of the RAM mounting system allows you to position your accessories for the best access and prevent damage due to shock and vibration. See RAM mount pages 6.08-6.11.

## Vehicle Attachments

Continued ▶

### Crown Work Assist® Ball Base

Rubber ball connected to oval base with mounting holes aligned to work with Crown Work Assist® Accessories. See pages 6.02-6.06.



| Part No.   | Description                             |
|------------|---|
| 351094-001 | 1" ball with 2.52" x 1.85" oval base    |
| 157749     | 1.5" ball with 2.52" x 1.85" oval base  |
| 160809     | 2.25" ball with 2.52" x 1.85" oval base |

### 2.5" Diameter Magnetic Base

Has pre-drilled holes, including the AMPS hole pattern. The magnetic base contains 3 rare earth magnets that hold firm to ferrous metals. The adapter designed to conceal the magnets is made of a durable plastic composite to prevent scratching the mounting surface.



| Part No.   | Description |
|------------|-------------|
| 351095-011 | 1" ball     |

### Round Base with Rubber Ball

Consists of a rubber ball connected to a flat round base. This mount has pre-drilled holes, including the universal AMPS hole pattern.



| Part No.   | Description  |
|------------|--|
| 351095-006 | 1" ball with 2 <sup>7</sup> / <sub>16</sub> " diameter base                      |
| 157750     | 1.5" ball with 2 <sup>1</sup> / <sub>2</sub> " diameter base                     |
| 351095-008 | 2.25" ball with 3 <sup>1</sup> / <sub>16</sub> " diameter base                   |
| 351095-009 | 2.25" ball with 3 <sup>1</sup> / <sub>16</sub> " diameter base, reinforced steel |

### V Base Ball and Straps

Fits circular and square rails from 1" to a max of 2.1" diameter. To mount, place the saddle shaped plate on the rail then wrap the metal clamp strap around the rail and plate. Tighten the screw knob on the metal strap with a screw driver until the strap has a firm hold on the rail.



| Part No.   | Description |
|------------|-------------|
| 351095-021 | 1" ball     |
| 351095-022 | 1.5" ball   |

### 3.25" Diameter Suction Cup

Suction cup designed to have an extra hold on any smooth, non-porous surface. For best results mount the suction cup on glass or non-porous plastic surface.



| Part No.   | Description |
|------------|-------------|
| 351095-010 | 1" ball     |

### Diamond Drill Down Base with Rubber Ball

Consists of a 1" diameter rubber ball connected at right angles to a 2.43" x 1.31" diamond base. The base has 2 holes 1.912" from center to center, matches the industry standard AMP's hole pattern and will connect to a large variety of RAM mounts and third party cradles.



| Part No.   | Description |
|------------|-------------|
| 351095-018 | 1" ball     |

## Vehicle Attachments



### Rubber Ball with Clamp Base - 4"

Fits on square rails up to 4" wide and 2 1/8" deep. Can fit much smaller rails if needed by angling.

| Part No.   | Description |
|------------|-------------|
| 351095-001 | 1" ball     |
| 160249-001 | 1.5" ball   |
| 160249-002 | 2.25" ball  |



### Rubber Ball with Clamp Base - 2.5"

Fits on square rails up to 2.5" wide.

| Part No.   | Description |
|------------|-------------|
| 351095-004 | 1.5" ball   |
| 351095-005 | 2.25" ball  |



Measure upright support as shown in image. Select clamp base which most closely matches the widest dimension.



### Overhead Guard Mount

The Overhead Guard Mount attaches to most any lift cage or overhead guard. Utilizing two identical plates of stamped steel with numerous common hole patterns and slots. 1.5" & 2.25" diameter bases may be attached to the same plate for multiple applications.

Part No.  
351095-019

Requires a square base: 1.5" ball (P.N. 351095-012) or 2.25" ball (P.N. 351095-013 or P.N. 351095-014).



## Arms



### Double Ball Socket Arm, Short

The short double socket arm, has a socket at both ends that fits ball bases. RAM socket technology allows for almost infinite adjustment and perfect viewing angles.

| Part No.   | Works With | Overall Length |
|------------|------------|----------------|
| 351095-027 | 1" ball    | 2.38"          |
| 351095-028 | 1.5" ball  | 3.5"           |
| 160808-002 | 2.25" ball | 5.0625"        |



### Double Ball Socket Arm, Long

Has a socket at both ends that fits ball bases. A single spring inside the arm opens the end sockets, allowing you to pivot the ball and socket connection. This socket technology allows for almost infinite adjustment and perfect viewing angles.

| Part No.   | Works With | Overall Length |
|------------|------------|----------------|
| 351095-030 | 1" ball    | 6"             |
| 351095-031 | 1.5" ball  | 9.125"         |
| 160808-003 | 2.25" ball | 12.875"        |



### Double Ball Socket Arm, Standard

Has socket at both ends that fits ball bases. A single spring inside the arm opens the end sockets, allowing you to pivot the ball and socket connection. Allows for almost infinite adjustment and perfect viewing angles.

| Part No.   | Works With | Overall Length |
|------------|------------|----------------|
| 351095-024 | 1" ball    | 3.69"          |
| 351095-025 | 1.5" ball  | 5.625"         |
| 160808-001 | 2.25" ball | 8.375"         |



### Adjustable Socket with Octagon Socket

Consists of double 1" diameter open ball sockets with a 360° rotation point at the center & a connecting swivel joint that rotates forward and back 180°. The rubber ball and socket at either end, and a central pivot point provides unsurpassed adjustability. The RAM ball sockets maximize ball coverage for optimal fit.

| Part No.   | Works With | Overall Length |
|------------|------------|----------------|
| 351095-033 | 1" ball    | 6.25"          |

## Mount Assembly



### Universal Mount with 2 Round Bases

Consists of one double socket arm and two round bases that contain the universal AMPS hole pattern. The hole pattern found on the round base adapter will connect to many RAM cradles, including all iPad cradles.

| Part No. | Ball Base  | Double Socket Arm | Overall Height | Ball Size |
|----------|------------|-------------------|----------------|-----------|
| 144357   | 351095-006 | 351095-027        | 5"             | 1"        |
| 150311   | 157750     | 351095-025        | 7.40"          | 1.5"      |



### RAM Mount Base

The RAM mount base assembly consists of a double socket arm and two ball bases. 157749 is designed to integrate with the Crown Work Assist clamp and the second base contains the universal AMPS hole pattern.

| Part No.   | Ball Base | Double Socket Arm | Ball Base | Overall Height | Ball Size |
|------------|-----------|-------------------|-----------|----------------|-----------|
| 157748-001 | 157749    | 351095-025        | 157750    | 7.42"          | 1.5       |
| 157748-002 | 157749    | 351095-028        | 157750    | 5.29"          | 1.5       |
| 157748-003 | 157749    | 351095-031        | 157750    | 10.92"         | 1.5       |



## Adapters

### Round Base with Rubber Ball

Consists of a rubber ball connected to a flat round base. This mount has pre-drilled holes, including the universal AMPS hole pattern.



| Part No.   | Description  |
|------------|--|
| 351095-006 | 1" ball with 2 <sup>1</sup> / <sub>16</sub> " diameter base                      |
| 157750     | 1.5" ball with 2 <sup>1</sup> / <sub>2</sub> " diameter base                     |
| 351095-008 | 2.25" ball with 3 <sup>1</sup> / <sub>16</sub> " diameter base                   |
| 351095-009 | 2.25" ball with 3 <sup>1</sup> / <sub>16</sub> " diameter base, reinforced steel |

### Square Base with Rubber Ball

Rubber ball, connected to a 3.625" square plate with a 75x75mm VESA hole pattern. The rubber ball is positioned 0.88" from the center of one edge.



| Part No.   | Description |
|------------|-------------|
| 351095-015 | 1.5" ball   |
| 351095-016 | 2.25" ball  |

### Square Base with Rubber Ball

Rubber ball, connected to a 4.75" square plate with 4x100mm holes and 4x75mm holes in each corner.



| Part No.   | Description                   |
|------------|-------------------------------|
| 351095-012 | 1.5" ball                     |
| 351095-013 | 2.25" ball                    |
| 351095-014 | 2.25" ball (reinforced steel) |

### Diamond Drill Down Base with Rubber Ball

Consists of a 1" diameter rubber ball connected at right angles to a 2.43" x 1.31" diamond base. The base has 2 holes 1.912" from center to center, matches the industry standard AMP's hole pattern and will connect to a large variety of RAM mount and third party cradles.



| Part No.   | Description |
|------------|-------------|
| 351095-018 | 1" ball     |

## Holders

Continued ▶

### X-Grip® Universal Holder

Has a clean and clever four leg design that sports great holding power without hiding your phone behind foam pads and plastic. Dimensions: width - 1.875" - 3.25", depth 0.875".



No ball base adapter required.

| Part No.   | Description |
|------------|-------------|
| 351095-034 | 1" ball     |

### X-Grip® Universal for 5" Phablets

Has a clean and clever four leg design that sports great holding power without hiding your phone or phablet behind foam pads and plastic. Compatible and interchangeable with a wide range of mounts. Dimensions: width 1.75"-4.5".



No ball base adapter required.

| Part No.   | Description |
|------------|-------------|
| 351095-035 | 1" ball     |

### Tough-Claw™ with X-Grip® Holder

Tough-Claw™ base and universal X-Grip® holder. The X-Grip® holder has a clean and clever four-leg design that sports great holding power without hiding your smartphone behind foam pads and plastic.



| Part No.   |
|------------|
| 351095-052 |

### Universal Finger-Grip™ Phone/Radio Holder

Designed to hold a large amount of cell phones & electronic devices — comes with 3 sets of 4 flexible rubber coated fingers placed along sides to grip your device. Fingers open by squeezing ends to open small finger arms. Bottom of the holder includes back plate that adds support to the device being held by the mount. Spine plate contains universal AMPs and 1.5" x 2" hole patterns. Min/Max with top & bottom plates: Height 5.25" to 6". Plates can be removed for larger devices.



| Part No.   |
|------------|
| 351095-036 |

Requires ball base adapter 157750.

### Power-Grip™ Universal Scanner Gun Cradle

Compatible with a wide range of ruggedized 2D barcode scanners. Accommodates pistol grip scanner guns with a maximum pistol grip of 1.4". Internal dimensions 3.47" x 2.16" x 4.9".



| Part No.   |
|------------|
| 351095-037 |

Requires ball base adapter 157750.



### RAM-X-Grip® III Universal Clamping Cradle for 10" Tablets

Spring loaded holder for large tablets, with or without a case. Accommodates netbooks as well. Dimensions:



| Tray Depth | Tray Thickness | Tray Width (Expansion) | Side Clamp Arm Height |
|------------|----------------|------------------------|-----------------------|
| 6.0"       | 1.0"           | 8.56" - 11.12"         | 2.75" max             |

| Part No.   |
|------------|
| 351095-045 |

Requires ball base adapter 157750.

### Universal Holder for Scanner Guns and Handheld Computers

Specially designed cradle that will hold most types of gun scanner handles. On the side of the cradle is a spring loaded lever that will securely hold the gun scanner in the cradle. Designed for pistol grip scanners.



Requires ball base adapter 157750.

| Part No.   |
|------------|
| 351095-039 |

### Tab-Tite™ Kit for Large Tablets

Fits most 10" tablets. Includes 2 sets of interchangeable cups to give the user a custom fit. Spring loaded. Cradle dimensions:



| Height         | Max. Width | Max. Edge Depth |
|----------------|------------|-----------------|
| 8.50" - 10.75" | 7.75"      | 0.56"           |
| 8.75" - 10.75" | 8.25"      | 1.10"           |

| Part No.   |
|------------|
| 351095-042 |

Requires ball base adapter 157750.

## Holders



### Tab-Lock™ Kit for Large Tablets

Same as 351095-042 except locks for theft deterrent. Cradle dimensions:

| Height         | Max. Width | Max. Edge Depth |
|----------------|------------|-----------------|
| 8.00" - 10.25" | 6.80"      | 0.50"           |
| 8.25" - 10.25" | 7.75"      | 0.56"           |

Requires ball base adapter 157750.

Part No.   
 351095-043



### Tab-Tite™ Kit for Small Tablets

Fits most 7-8" tablets. Includes 3 sets of interchangeable cups to give the user a custom fit. Spring loaded retention to hold device securely on the forklift. It is compatible with the following tablets with or without skins, sleeves or cases: Archos 7, Asus EEE Pad Memo, Asus Tough-ETBW11AA, Barnes & Nobel NOOKcolor, BlackBerry Playbook, Dell Streak 7, HTC Flyer, Google Nexus 7, Samsung Galaxy. Cradle is compatible with any tablet that will fit the dimensions listed below. It is important to verify the dimensions of your tablet with a case/sleeve/skin when determining the overall size. Cradle dimensions:

| Height         | Max. Width | Max. Edge Depth |
|----------------|------------|-----------------|
| 6.80" - 9.000" | 5.31"      | 0.125" - 0.56"  |
| 7.00" - 9.100" | 4.70"      | 0.125" - 0.44"  |
| 7.30" - 9.620" | 5.31"      | 1.06"           |

Requires ball base adapter 157750.

Features:

1. Support cups contain open slots to fit tablets of various sizes
2. Back plate can support various size support cups
3. Spring loaded tension provides secure support for your tablet
4. Spring loaded cradle allows for quick release of your tablet
5. Full access to all ports



### Tab-Lock™ Kit for Small Tablets

Same as 351095-040 except locks for theft deterrent. Cradle dimensions:

| Height         | Max. Width | Max. Edge Depth |
|----------------|------------|-----------------|
| 6.55" - 9.80"  | 5.31"      | 0.125" - 0.56"  |
| 6.75" - 9.90"  | 4.70"      | 0.125" - 0.44"  |
| 7.05" - 10.42" | 5.31"      | 1.06"           |

Requires ball base adapter 157750.

Part No.   
 351095-041

### Universal Portable Printer Cradle

Uses unique patent pending spring-loaded mechanism that holds strong, yet provides easy removal for printer storage. At each end of cradles are side clamping plates designed to fit cleanly around edges of a printer.

| Part No.   | Clamping Dimensions | Max. Height |
|------------|---------------------|-------------|
| 351095-054 | 6.625" - 10.5"      | 2.5"        |
| 351095-055 | 5.625" - 9.5"       | 1.75"       |



### Universal X-Grip® II Tablet Holder with 1.5" Ball for Small Tablets

Four leg design has great holding power and does not hide your tablet behind foam pads or plastic. Spring loaded holder and 1.5" rubber ball connect to the back of the base. Includes extra easy access grip knobs located on the back of the holder for quick release of your tablet. This holder expands and contracts for perfect fit of most 7" tablets.

Part No.   
 351095-046

| Min. Width | Max. Width | Depth  |
|------------|------------|--------|
| 2.25"      | 5.75"      | 0.875" |

Note: Devices 2.25" in width must be a minimum of 7" in height to fit.

No ball base adapter required.



### Universal Laptop Mount Tough Tray II™

Spring loaded holder for large tablets, with or without a case. Accommodates netbooks as well. Dimensions:

| Part No.   | Tray Depth | Tray Thickness | Tray Width (Expansion) | Side Clamp Arm Height |
|------------|------------|----------------|------------------------|-----------------------|
| 351095-044 | 6.0"       | 1.0"           | 8.56" - 11.12"         | 2.75" max             |

Requires ball base adapter 157750.



### Universal Laptop Tough Tray™ Holder with Flat Retaining Arm

Spring loaded expandable tray that accommodates 10 to 16 inch wide laptops. Includes four flat side clamping arms that allow your laptop to close completely while in the tray. These arms can be moved both vertically and horizontally allowing for a custom fit for varying thicknesses of laptops and the freedom of not blocking ports or drives. Hole patterns on perimeter of tray facilitate the mounting of additional RAM systems to support GPS, PDAs or other electronics.

Part No.   
 351095-051

| Tray Depth | Tray Thickness | Side Clamp Arm Height |
|------------|----------------|-----------------------|
| 10.0"      | 2.125"         | 0.5" to 1.75"         |



### Keyboard Mount

This simple design clamps an 8" tube between any RAM tablet cradle, and the Patent Pending Roto-View™ round adapter plate allows for adjustment to accommodate many tablet configurations, including use in both landscape and portrait mode. The 8" tube has a 1" ball on the end which connects to a standard RAM double socket arm and Magnetic Power Plate III for easy placement and removal of the keyboard.

Part No.   
 351095-057



### Locking Knob - Locks the Arms

Includes a brass thread for 1" or 1.5" socket arms, thus allowing you to disengage the screwing of the knob. Once you have set your mount in the location you need, you can lock it in place and feel safe that your mounted device will stay right where you left it.

| Part No.   | Thread Size    | Works With    |
|------------|----------------|---------------|
| 351095-047 | ¼" - 20 thread | 1" ball arm   |
| 351095-048 | ⅝" - 18 thread | 1.5" ball arm |

## Camera Systems

Design a camera system with three easy pieces: camera, cable and monitor. The system you select can be easily installed and is plug-and-play.

Cameras can provide a fork view, front view, rear view, or mid mast view. Please contact your local dealer for assistance in choosing the right parts to complete your system.

### How to Order:



## Cameras

### Camera FAMOS

- Next generation CMOS sensor
- High light sensitivity: 0.05 lux
- High resolution: 640\*480
- Integrated safety ticker
- Openings angles from 16°-129°
- Camera has a 1.6 ft. cable including a waterproof 4 pin male connector



|                    | NTSC       | PAL        |
|--------------------|------------|------------|
| Camera 129°        | 340095-143 | 340095-156 |
| Camera 118°        | 340095-144 | 340095-157 |
| Camera 102°        | 340095-145 | 340095-158 |
| Camera 118°-Mirror | 340095-146 | 340095-159 |
| Camera 69°         | 340095-147 | 340095-160 |
| Camera 58°         | 340095-148 | 340095-161 |
| Camera 24°         | 340095-149 | 340095-162 |
| Camera 16°         | 340095-150 | 340095-163 |

### Camera FAMOS

- Camera has a 0.8 ft. cable including a 6 pin male Deutsch connector



|            | NTSC       | PAL        |
|------------|------------|------------|
| Camera 80° | 147125-001 | 147125-002 |

### Camera FAMOS IR LED

- Day/Night camera including 15 high power infrared LEDs 850nm
- Camera has a 1.6 ft. cable including a waterproof 4 pin male connector



|                    | NTSC       | PAL        |
|--------------------|------------|------------|
| Camera 69° IR LED  | 340095-151 | 340095-164 |
| Camera 118° IR LED | 340095-152 | 340095-165 |

### Cameras

- NTSC (60Hz) used in North America
- PAL (50Hz) Check Global Guidelines
- Operating temperature -40F to +185F
- Lens is chemically hardened and has an anti-dust and condensation coating
- Impact and vibration proof
- 2-year warranty

### Camera AMOS CPH



- Extremely robust small camera for mounting on a vulnerable position
- Color camera
- Fixed lens angle at 51°
- Camera has a 1.6 ft. cable including a waterproof 4 pin male connector

|                                    | NTSC       | PAL        |
|------------------------------------|------------|------------|
| Camera (600 mm cable/approx. 2')   | 340095-166 | 340095-153 |
| Camera (200 mm cable/approx. 0.6') | 340095-168 | 340095-167 |

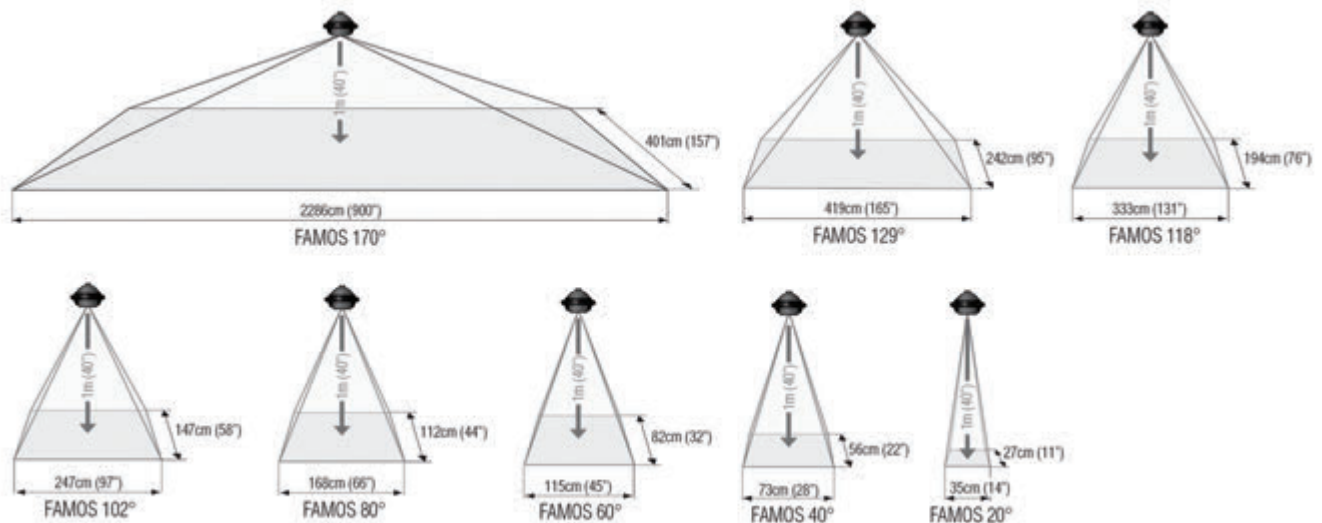

The measurements given above are theoretical. Practical situations may deviate.

## Monitors

### Monitors

- Liquid Crystal Display module, LED backlight
- Impact and vibration resistance
- Power protected against induction voltages, load dumps, over and under voltage
- High resolution pixel WVGA 800X480
- Full on screen display in 12 languages
- Water tight molded connectors
- 2-year warranty



### Monitor 7" RLED R 4 CS (12-60V)

- Part No.** 340095-014
- 13.1ft. multicable open wired w/4p female connector
  - 5.2 inch mounting bracket
  - Suitable for open cold store applications

### Monitor 7" RLED RC 4 CS (12-60V)

- Part No.** 340095-015
- 13.1 ft. multicable open wired w/4p female connector
  - 7.5 inch adjustable mounting bracket with clamp
  - Suitable for open cold store applications

### Monitor 7" RLED Serial R 6 (18-30V)

- Part No.** 340095-016
- 19.7 ft. multicable open wired w/7p female connector
  - 5.2 inch mounting bracket
  - Used with P.N. 340095-155

### Monitor 7" RLED CAN SRD 6 (12-60V)

- Part No.** 340095-017
- 19.7 ft. multicable open wired w/7p female connector
  - 5.2 inch mounting bracket
  - Specifically designed for RadarEye systems

### Monitor 12" RLED R 4 (12-30V)

- Part No.** 340095-018
- 13.1ft. multicable open wired w/4p female connector
  - 7.5 inch mounting bracket

### Monitor 12" RLED Serial R 6 (12-30V)

- Part No.** 340095-019
- 19.7 ft. multicable open wired w/7p female connector
  - 7.5 inch mounting bracket
  - To be used in combination with 340095-155

### Monitor 12" RLED CAN SRD 6 (12-30V)

- Part No.** 340095-020
- 19.7 ft. multicable open wired w/7p female connector
  - 7.5 inch adjustable mounting bracket with clamp
  - Specifically designed for RadarEye systems

## Cables

### Dynamic Cable (Mast Cable) 4 Pin

| Part Number | Length   |
|-------------|----------|
| 340095-021  | 1.6 ft.  |
| 340095-022  | 3.3 ft.  |
| 340095-023  | 10.4 ft. |
| 340095-024  | 11.5 ft. |
| 340095-025  | 16.4 ft. |
| 340095-026  | 19.7 ft. |
| 340095-027  | 26.2 ft. |
| 340095-028  | 29.5 ft. |
| 340095-029  | 32.8 ft. |
| 340095-030  | 36.1 ft. |
| 340095-031  | 39.4 ft. |
| 340095-032  | 44.9 ft. |
| 340095-033  | 45.9 ft. |

### Three-Stage Mast Example

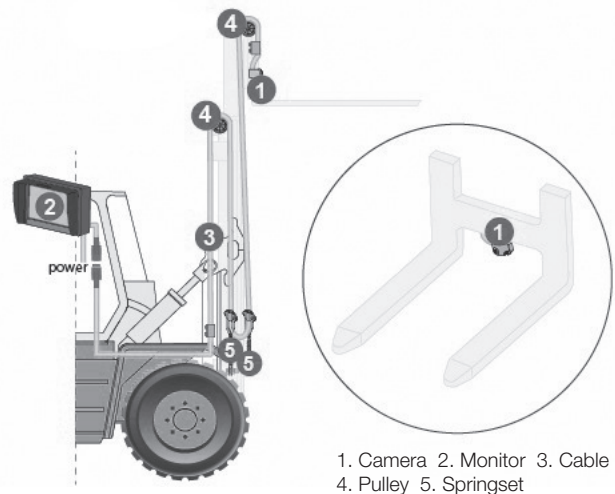

## Options

### Pulley

**Part No.**  
340095-086



- 3.1 inch diameter
- Stainless steel brackets and anodized aluminum pulley
- Suitable for -58° F to 302° F

### Spring Set

**Part No.**  
340095-087



For pre-tensioning mast cable

### Switchers

**Part No.**  
340095-089 Switcher UNI IP54  
340095-090 Switcher UNI IP67



Inputs and power supply for three cameras and in combination with a Y-split cable: Four cameras.

- 4 pin output for monitor
- Cameras can be switched over automatically or manually

## Fork Level Indicator



**Part No.**  
340402

### Accu-Tilt

Accu-Tilt is a Fork Tilt Level Indicator that shows the operator the level of the forks at all times, thereby reducing potential damage by piercing product or racking and increasing productivity by eliminating the guess work. Additionally, the Accu-Tilt's Fork Tilt Level Indicator will also indicate to the operator the correct fork angle to travel with a load as well as parking the lift truck.

\* For use on Counterbalance trucks

## Forklift Laser Guidance System

Continued ▶

The Forklift Laser Guidance System provides operators a continuous visual reference of fork position which aids in increasing safety, accuracy, and productivity, while reducing product damage.

The laser projects a line or dot onto the pallet or product indicating the level of the forks which allows operator heightened visibility and more accurate fork placement.

### Laser Models:

- Basic Standard - Basic standard
- Cold Storage - Designed for low-temperature and high-moisture environments
- Height Control - Designed only to operate at 7' and above
- Remote Power - Comes with key fob power control

### Laser Types:

- Line - Best for low-light areas such as warehouses
- Dot - Best for cold storage and outdoor usage

### Features For Battery-Operated Laser Guidance:

- Contains two lithium ion batteries
- Charger included
- Shuts off after 4 mins without movement, saving battery life
- Automated vibration controlled start
- Heavy duty
- Self contained
- Quick battery change

### Mounting:

- Single laser, dual laser, and hard wired series units mount directly to the forklift carriage in less than five minutes. Fork mount laser units attach to the fork directly.
- Laser guides fit class II carriages
- Class III or non standard carriages require fork mount

**INSTALL IN  
LESS THAN 5  
MINUTES**



### Batteries:

- 80+ continuous hours of life per battery
- Quick charge 3 hours; full charge in 8 hours
- Batteries are double shrink wrapped for durability
- Batteries are equipped with an Over-Current Protection System

### Single Laser Series

| Red Laser Part Number | Green Laser Part Number | Description                                     | Laser Type |
|-----------------------|-------------------------|---|------------|
| 351093-001            | 351093-001-G            | Basic Std                                       | Line       |
| 351093-001-D          | 351093-001-D-G          | Basic Std                                       | Dot        |
| 351093-002            | 351093-002-G            | Water Resistant                                 | Line       |
| 351093-002-D          | 351093-002-D-G          | Cold Storage - Water Resistant                  | Dot        |
| 351093-003            | 351093-003-G            | Height Control                                  | Line       |
| 351093-003-D          | 351093-003-D-G          | Height Control                                  | Dot        |
| 351093-019            | 351093-019-G            | Height Control - Water Resistant                | Line       |
| 351093-019-D          | 351093-019-D-G          | Height Control - Cold Storage - Water Resistant | Dot        |

⚠️ **WARNING:** Cancer and reproductive harm - [www.P65Warnings.ca.gov](http://www.P65Warnings.ca.gov)



351093-003-D

### Dual Laser Series

| Red Laser Part Number | Green Laser Part Number | Description                                     | Laser Type |
|-----------------------|-------------------------|---|------------|
| 351093-004            | 351093-004-G            | Basic Std                                       | Dot & Line |
| 351093-005            | 351093-005-G            | Cold Storage-Water Resistant                    | Dot & Dot  |
| 351093-006            | 351093-006-G            | Height Control                                  | Dot & Line |
| 351093-016            | 351093-016-G            | Basic Std - Hard Wired                          | Dot & Line |
| 351093-017            | 351093-017-G            | Cold Storage-Water Resistant                    | Dot & Dot  |
| 351093-018            | 351093-018-G            | Height Control                                  | Dot & Line |
| 351093-020            | 351093-020-G            | Height Control - Cold Storage - Water Resistant | Dot & Dot  |
| 351093-040            | 351093-040-G            | Basic - Remote Power                            | Dot & Line |
| 351093-041            | 351093-041-G            | Cold Storage-Water Resistant-Remote Power       | Dot & Dot  |

The dual laser feature is designed for repetitive moving of product. This feature incorporates two distinct lasers to aid the operator. The first laser directs the forks into the pallet and the second laser guides the pallet onto the rack.

⚠️ **WARNING:** Cancer and reproductive harm - [www.P65Warnings.ca.gov](http://www.P65Warnings.ca.gov)



351093-006

## Fork Mount Laser Series

| Red Laser Part Number | Green Laser Part Number | Description  | Laser Type |
|-----------------------|-------------------------|--|------------|
| 351093-007            | 351093-007-G            | Basic Std  | Line       |
| 351093-007-D          | 351093-007-D-G          | Basic Std  | Dot        |
| 351093-008            | 351093-008-G            | Water Resistant                                    | Line       |
| 351093-008-D          | 351093-008-D-G          | Cold Storage-Water Resistant                       | Dot        |
| 351093-009            | 351093-009-G            | Height Control                                     | Line       |
| 351093-009-D          | 351093-009-D-G          | Height Control                                     | Dot        |
| 351093-025            | 351093-025-G            | Fork Mount - Water Resistant - 1 3/4"              | Line       |
| 351093-025-D          | 351093-025-D-G          | Fork Mount Cold Storage - Water Resistant - 1 3/4" | Dot        |
| 351093-036            | 351093-036-G            | Height Control - Water Resistant                   | Line       |
| 351093-036-D          | 351093-036-D-G          | Height Control - Cold Storage-Water Resistant      | Dot        |
| 351093-037            | 351093-037-G            | Basic - Remote Power                               | Line       |
| 351093-037-D          | 351093-037-D-G          | Basic - Remote Power                               | Dot        |
| 351093-038            | 351093-038-G            | Water Resistant-Remote Power                       | Line       |
| 351093-038-D          | 351093-038-D-G          | Cold Storage-Water Resistant-Remote Power          | Dot        |



351093-009-D

Fork mount lasers are designed for the non-standard fork carriages. Lasers are mounted directly to the fork of the lift truck.

**Note:** All fork mount lasers are custom parts. 30-day lead time.

**WARNING:** Cancer and reproductive harm - [www.P65Warnings.ca.gov](http://www.P65Warnings.ca.gov)

## Hard Wired Laser Series

| Red Laser Part Number | Green Laser Part Number | Description  | Laser Type |
|-----------------------|-------------------------|--|------------|
| 351093-012            | 351093-012-G            | Basic Std  | Line       |
| 164440-001            | 351093-042-G            | Basic Std - Orange; Includes Cable & Deutsch Connector       | Line       |
| 351093-012-D          | 351093-012-D-G          | Basic Std  | Dot        |
| 351093-013            | 351093-013-G            | Water Resistant  | Line       |
| 351093-013-D          | 351093-013-D-G          | Cold Storage-Water Resistant                                 | Dot        |
| 351093-014            | 351093-014-G            | Height Control   | Line       |
| 351093-014-D          | 351093-014-D-G          | Height Control   | Dot        |
| 351093-015            | 351093-015-G            | Water Resistant - Height Control                             | Line       |
| 351093-015-D          | 351093-015-D-G          | Cold Storage - Water Resistant - Height Control              | Dot        |
| 351093-021            | 351093-021-G            | Basic - Remote Power   | Line       |
| 351093-021-D          | 351093-021-D-G          | Basic - Remote Power   | Dot        |
| 164440-002            | 351093-024-G            | Water Resistant - Orange; Includes Cable & Deutsch Connector | Line       |



164440-002

Includes cable or deutsch connector. Oil and water resistant wires are hard wired directly into truck battery with voltage systems between 12-55 DC. Matching pigtails are provided for power connection. (Wiring for most not included.) Experienced personnel are recommended for self-installation.

**WARNING:** Cancer and reproductive harm - [www.P65Warnings.ca.gov](http://www.P65Warnings.ca.gov)

## Remote Powered Laser Series

| Red Laser Part Number | Green Laser Part Number | Description   | Laser Type |
|-----------------------|-------------------------|---|------------|
| 351093-030            | 351093-030-G            | Water Resistant - Remote Power                                    | Line       |
| 351093-030-D          | 351093-030-D-G          | Cold Storage - Water Resistant - Remote Power                     | Dot        |
| 351093-031            | 351093-031-G            | Dual - Remote Power   | Dot & Line |
| 351093-032            | 351093-032-G            | Dual - Cold Storage - Water Resistant - Remote Power              | Dot & Dot  |
| 351093-033            | 351093-033-G            | Hard Wired - Water Resistant - Remote Power                       | Line       |
| 351093-033-D          | 351093-033-D-G          | Hard Wired - Cold Storage - Water Resistant - Remote Power        | Dot        |
| 351093-034            | 351093-034-G            | Hard Wired - Dual - Remote Power                                  | Dot & Line |
| 351093-035            | 351093-035-G            | Hard Wired - Dual - Cold Storage - Water Resistant - Remote Power | Dot & Dot  |

Remote Power – Comes with key fob power control.

**WARNING:** Cancer and reproductive harm - [www.P65Warnings.ca.gov](http://www.P65Warnings.ca.gov)

## Accessories

| Part No.   | Description  |
|------------|--|
| 351093-022 | Face Plate Assembly  |
| 351093-023 | Power Plug Adapter (works in Australia, China & New Zealand) |
| 351093-026 | Replacement Pigtail  |
| 351093-027 | Rechargeable Lithium Ion Battery                             |
| 351093-028 | Lithium Charger  |
| 351093-043 | Polarity Changer   |

**WARNING:** Cancer and reproductive harm - [www.P65Warnings.ca.gov](http://www.P65Warnings.ca.gov)

# Forklift Laser Guidance System

## Forklift Laser Guidance Systems

| Power Source | Laser Output | Mounting Type | Laser Type | Red Laser Part No. | Green Laser Part No. | Description  | Water Resistant Seal | Cold Storage | Height Control | Remote Power |
|--------------|--------------|---------------|------------|--------------------|----------------------|--|----------------------|--------------|----------------|--------------|
| Battery      | Dot          | Carriage      | Single     | 351093-001-D       | 351093-001-D-G       | Basic Std  |                      |              |                |              |
| Battery      | Dot          | Carriage      | Single     | 351093-002-D       | 351093-002-D-G       | Cold Storage - Water Resistant                             | •                    | •            |                |              |
| Battery      | Dot          | Carriage      | Single     | 351093-003-D       | 351093-003-D-G       | Height Control   |                      |              | •              |              |
| Battery      | Dot          | Carriage      | Single     | 351093-019-D       | 351093-019-D-G       | Height Control - Cold Storage - Water Resistant            | •                    | •            | •              |              |
| Battery      | Dot          | Carriage      | Single     | 351093-030-D       | 351093-030-D-G       | Cold Storage - Water Resistant - Remote Power              | •                    | •            |                | •            |
| Battery      | Dot          | Fork Mount    | Single     | 351093-007-D       | 351093-007-D-G       | Basic Std  |                      |              |                |              |
| Battery      | Dot          | Fork Mount    | Single     | 351093-008-D       | 351093-008-D-G       | Cold Storage - Water Resistant                             | •                    | •            |                |              |
| Battery      | Dot          | Fork Mount    | Single     | 351093-009-D       | 351093-009-D-G       | Height Control   |                      |              | •              |              |
| Battery      | Dot          | Fork Mount    | Single     | 351093-036-D       | 351093-036-D-G       | Height Control - Cold Storage - Water Resistant            | •                    | •            | •              |              |
| Battery      | Dot          | Fork Mount    | Single     | 351093-037-D       | 351093-037-D-G       | Basic - Remote Power                                       |                      |              |                | •            |
| Battery      | Dot          | Fork Mount    | Single     | 351093-038-D       | 351093-038-D-G       | Cold Storage - Water Resistant - Remote Power              | •                    | •            |                | •            |
| Battery      | Dot          | Fork Mount    | Single     | 351093-025-D       | 351093-025-D-G       | Cold Storage- Water Resistant - 1 3/4"                     | •                    | •            |                |              |
| Battery      | Dot & Dot    | Carriage      | Dual       | 351093-005         | 351093-005-G         | Cold Storage - Water Resistant                             | •                    | •            |                |              |
| Battery      | Dot & Dot    | Carriage      | Dual       | 351093-020         | 351093-020-G         | Cold Storage - Water Resistant - Height Control            | •                    | •            | •              |              |
| Battery      | Dot & Dot    | Carriage      | Dual       | 351093-041         | 351093-041-G         | Cold Storage - Water Resistant - Remote Power              | •                    | •            |                | •            |
| Battery      | Dot & Dot    | Carriage      | Dual       | 351093-032         | 351093-032-G         | Dual - Cold Storage - Water Resistant - Remote Power       | •                    | •            |                | •            |
| Battery      | Line         | Carriage      | Single     | 351093-001         | 351093-001-G         | Basic Std  |                      |              |                |              |
| Battery      | Line         | Carriage      | Single     | 351093-003         | 351093-003-G         | Height Control   |                      |              | •              |              |
| Battery      | Line         | Carriage      | Single     | 351093-019         | 351093-019-G         | Height Control - Water Resistant                           | •                    |              | •              |              |
| Battery      | Line         | Carriage      | Single     | 164440-002         | 351093-024-G         | Water Resistant (deutsch connectors)                       | •                    |              |                |              |
| Battery      | Line         | Carriage      | Single     | 351093-030         | 351093-030-G         | Water Resistant  | •                    |              |                | •            |
| Battery      | Line         | Fork Mount    | Single     | 351093-007         | 351093-007-G         | Basic Std  |                      |              |                |              |
| Battery      | Line         | Fork Mount    | Single     | 351093-008         | 351093-008-G         | Water Resistant  | •                    |              |                |              |
| Battery      | Line         | Fork Mount    | Single     | 351093-009         | 351093-009-G         | Height Control   |                      |              | •              |              |
| Battery      | Line         | Fork Mount    | Single     | 351093-036         | 351093-036-G         | Height Control - Water Resistant                           | •                    |              | •              |              |
| Battery      | Line         | Fork Mount    | Single     | 351093-037         | 351093-037-G         | Basic -Remote Power  |                      |              |                | •            |
| Battery      | Line         | Fork Mount    | Single     | 351093-038         | 351093-038-G         | Water Resistant - Remote Power                             | •                    |              |                | •            |
| Battery      | Line         | Fork Mount    | Single     | 351093-025         | 351093-025-G         | Water Resistant - 1 3/4"                                   | •                    |              |                |              |
| Battery      | Line & Dot   | Carriage      | Dual       | 351093-004         | 351093-004-G         | Basic Std  |                      |              |                |              |
| Battery      | Line & Dot   | Carriage      | Dual       | 351093-006         | 351093-006-G         | Height Control   |                      |              | •              |              |
| Battery      | Line & Dot   | Carriage      | Dual       | 351093-031         | 351093-031-G         | Dual - Remote Power  |                      |              |                | •            |
| Battery      | Line & Dot   | Fork Mount    | Dual       | 351093-040         | 351093-040-G         | Basic-Remote Power   |                      |              |                | •            |
| Hard Wired   | Dot          | Carriage      | Single     | 351093-012-D       | 351093-012-D-G       | Basic Std  |                      |              |                |              |
| Hard Wired   | Dot          | Carriage      | Single     | 351093-013-D       | 351093-013-D-G       | Cold Storage - Water Resistant                             | •                    | •            |                |              |
| Hard Wired   | Dot          | Carriage      | Single     | 351093-014-D       | 351093-014-D-G       | Height Control   |                      |              | •              |              |
| Hard Wired   | Dot          | Carriage      | Single     | 351093-015-D       | 351093-015-D-G       | Cold Storage - Water Resistant - Height Control            | •                    | •            | •              |              |
| Hard Wired   | Dot          | Carriage      | Single     | 351093-033-D       | 351093-033-D-G       | Hard Wired - Cold Storage - Water Resistant - Remote Power | •                    | •            |                | •            |
| Hard Wired   | Dot          | Carriage      | Single     | 351093-021-D       | 351093-021-D-G       | Basic - Remote Power                                       |                      |              |                | •            |
| Hard Wired   | Dot & Dot    | Carriage      | Dual       | 351093-017         | 351093-017-G         | Cold Storage - Water Resistant                             | •                    | •            |                |              |
| Hard Wired   | Dot & Dot    | Carriage      | Dual       | 351093-035         | 351093-035-G         | Dual - Cold Storage - Water Resistant - Remote Power       | •                    | •            |                | •            |
| Hard Wired   | Line         | Carriage      | Single     | 164440-001         | 351093-042-G         | Basic Std (deutsch connectors)                             |                      |              |                |              |
| Hard Wired   | Line         | Carriage      | Single     | 164440-002         | 351093-024-G         | Water Resistant (deutsch connectors)                       | •                    |              |                |              |
| Hard Wired   | Line         | Carriage      | Single     | 351093-012         | 351093-012-G         | Basic Std  |                      |              |                |              |
| Hard Wired   | Line         | Carriage      | Single     | 351093-013         | 351093-013-G         | Water Resistant  | •                    |              |                |              |
| Hard Wired   | Line         | Carriage      | Single     | 351093-014         | 351093-014-G         | Height Control   |                      |              | •              |              |
| Hard Wired   | Line         | Carriage      | Single     | 351093-015         | 351093-015-G         | Height Control - Water Resistant                           | •                    |              | •              |              |
| Hard Wired   | Line         | Carriage      | Single     | 351093-021         | 351093-021-G         | Basic - Remote Power                                       |                      |              |                | •            |
| Hard Wired   | Line         | Carriage      | Single     | 351093-033         | 351093-033-G         | Hard Wired - Water Resistant - Remote Power                | •                    |              |                | •            |
| Hard Wired   | Line & Dot   | Carriage      | Dual       | 351093-016         | 351093-016-G         | Basic Std  |                      |              |                |              |
| Hard Wired   | Line & Dot   | Carriage      | Dual       | 351093-018         | 351093-018-G         | Height Control   |                      |              | •              |              |
| Hard Wired   | Line & Dot   | Carriage      | Dual       | 351093-034         | 351093-034-G         | Dual - Remote Power  |                      |              |                | •            |

⚠️WARNING: Cancer and reproductive harm - [www.P65Warnings.ca.gov](http://www.P65Warnings.ca.gov)

WORK ASSIST®

## Forklift Covers & Enclosures

### Soft Cab

- Protect your largest investment and keep your product moving with Crown's C-5 Series with soft cab.
- Durable modular soft cabin construction.
- Soft side zipper style doors and rear window can be rolled up or down as weather conditions change.
- Options are available with a new truck purchase or as an aftermarket add-on.

#### Part

| Part Number | Description                                       |
|-------------|---|
| 154633      | Safety glass windshield with wiper and washer kit |
| 154631      | Acrylic top kit                                   |
| 154634      | Soft rear window kit                              |
| 154632      | Soft left and right doors kit                     |
| 151482      | Entry assist handle kit                           |
| 151573      | Harness kit                                       |

**Note:** Order all kits for a full cabin.



### Forklift Enclosures - Atrium

| Part Number | Description                  | Size                  |
|-------------|------------------------------|-----------------------|
| 300125-001  | Standard - Super Clear Vinyl | Fits up to 6,000 lbs  |
| 300125-002  | Large - Super Clear Vinyl    | Fits 6,000-12,000 lbs |
| 300125-006  | XL - Super Clear Vinyl       | 12,000 lbs+           |

Great for the yard and warehouse. Keeps the rain or dust away from the operator. Zippered doors can be shut or unzipped and folded back into place while working. Universal for most lifts. UV yellow inhibitor. Freeze point flexibility. Marine grade stitching. Attaches in seconds. Super clear material.

**WARNING:** Cancer and reproductive harm - [www.P65Warnings.ca.gov](http://www.P65Warnings.ca.gov)



### Forklift Storage Cover

| Part Number | Description            | Size  |
|-------------|------------------------|---|
| 300125-005  | Forklift Storage Cover | Fits up to 8,000 lbs<br>100"L x 45"W x 80"H |

**WARNING:** Cancer and reproductive harm - [www.P65Warnings.ca.gov](http://www.P65Warnings.ca.gov)



300125-003

### Forklift Cap Covers

| Part Number | Description              | Size            |
|-------------|--------------------------|-----------------|
| 300125-003  | Super Clear Tinted Vinyl | 52.5" L x 46" W |
| 300125-004  | Super Clear Vinyl        | 40" L x 45.5" W |



300125-004

Attaches with built-in bungee cords; just wrap around roof poles and attach back to itself. Attaches in seconds. Fits all lifts. Super clear material. Absorbs impacts. Protection from sun (tinted version only). Protection from rain and falling debris. Great for all warehouses and yards.

**WARNING:** Cancer and reproductive harm - [www.P65Warnings.ca.gov](http://www.P65Warnings.ca.gov)



## Section 7

# InfoLink<sup>®</sup>, PTH 50, Chain, Forks and Attachment Parts

### Contents

|                                      |      |
|--------------------------------------|------|
| InfoLink <sup>®</sup>                | 7.02 |
| Crown PTH 50 Series Pallet Truck     | 7.05 |
| Crown PTH 50S/PS Series Pallet Truck | 7.06 |
| Leaf Chain                           | 7.07 |
| Roller Chain                         | 7.08 |
| Fork Pin Kits                        | 7.08 |
| Forks                                | 7.09 |
| Fork Extensions                      | 7.11 |
| Magnetic Fork Covers                 | 7.11 |
| Fork Attachments                     | 7.12 |
| Cascade OEM Parts                    | 7.13 |
| Rightline Fork Assemblies            | 7.16 |
| Rightline Cross Reference            | 7.17 |

#### **New Items:**

Bull Dawg Pallet Protector - p. 7.12

Note: 1910.178(q)(5) (1998) of the Occupational Safety and Health Act (OSHA) requires that "All parts of any such industrial truck requiring replacement shall be replaced only by parts equivalent as to safety with those used in the original design."

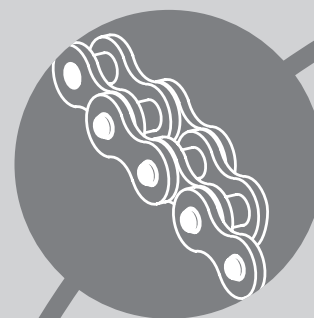

# Make your Connection



7" Touch Display



3" Display

|  |  |   |   |
|--|--|---|---|
| <b>SAFETY</b>                                | Complete electronic pre-shift inspections, manage operator certifications and monitor impacts            | ● | ● |
| <b>PRODUCTIVITY</b>                          | Compare operator or team activity to department/shift benchmarks, identify long-term and seasonal trends | ● | ● |
| <b>UPTIME</b>                                | Schedule planned maintenance and communicate maintenance issues  | ● | ● |
| <b>ASSET MANAGEMENT</b>                      | Manage individual lift truck assets or entire fleet across multiple locations                            | ● | ● |
| <b>COST REDUCTION</b>                        | Prevent expensive repairs, reduce damage from impacts and avoid regulatory penalties                     | ● | ● |
| <b>TOUCH USER INTERFACE WITH WIDGETS</b>     |  | ● |   |
| <b>SAFETY REMINDERS AND CHECKLIST IMAGES</b> |  | ● |   |

## InfoLink Services: Achieve More With Your Connection

Crown's InfoLink Services can help provide the additional support needed to ensure your success. Supplemental services include those designed to help you create a solid foundation, data integration assistance with other platforms and additional customizations as you continue your InfoLink journey.

- Prepare your team for the InfoLink system with the **RightStart™** program that tailors the implementation process to meet your operational needs.
- Re-energize your organization with InfoLink using additional support programs by assessing your company's current state of InfoLink usage and customizing a plan to boost engagement.
- Integrate InfoLink data into your business systems through **InfoLink Data Services.**
  - KPI Connect – time clock, WMS, LMS
  - Maintenance Connect – hour meter data
  - Human Resource Connect – employee and certification data
  - FleetSTATS® – fleet maintenance management system
- Optimize your InfoLink experience with Custom Reporting that provides the analytics you need in a format and frequency that fits your business.

We make it easy to leverage Crown's extensive fleet management expertise by utilizing our InfoLink Services.

Contact your local Crown retailer today for an on-site business review and make the most of your connections.

Visit [crown.com](http://crown.com)



**InfoLink®**

**7" Touch Display**

| Part Number | Description   |
|-------------|---|
| 161035-001* | 7" Touch Display                                      |
| 162136-010  | Rear Housing  |
| 164592-001  | Tablet Housing Clamp Kit                              |
| 159605      | Display Harness                                       |
| 159618-001  | Short CAN T-harness                                   |
| 159618-002  | Long CAN T-harness (SP and RR/RM 48" Chassis/S-Class) |
| 164714-001  | Tablet Battery  |
| 060064-029  | Security Screw  |
| 164461-001  | Tablet Screen Protector                               |



**Note:** Experienced personnel is recommended for installation. For assistance call InfoLink help line @ 419-629-3771 opt. 2.  
\*Battery (P.N. 164714-001) not included. Needs to be ordered separately.

**Prox Reader**



**HID Multi-Class Prox Reader**

Part Number - 066077

Allows operators to log into equipment using existing HID compatible badges, fobs, or stickers.



**HID Card**

Part Number - 340086

Used to log into InfoLink Modules with Multi-Class Prox Reader.



**HID Sticker**

Part Number - 340087

HID sticker can be placed on the back of existing non-HID badges to log into InfoLink modules with Multi-Class Reader.



**ioProx Proximity Card Reader**

Part Number - H52718-501

Allows operators to log into equipment using existing ioProx compatible badges, fobs, or stickers.

**Mounting**



**CG CD InfoLink Clamp Kit**

Part Number - 330145

Standard clamp needed for installing the InfoLink module to the front OHG.



**Ram Mount OHG Clamp**

Part Number - 160249-001

Fits on square rails up to 4" wide and 2 1/8" deep. Can fit much smaller rails by angling. 1 1/2" ball.

Used with RAM Mount kit to mount a module to equipment with a rectangular OHG.



**Ram Mount Kit**

Part Number - 157698-001

Includes: One double socket arm, two round bases, one clamp plate & hardware. Used on non-Crown equipment to mount InfoLink module.



**Work Assist Clamp**

Part Number - 130145

Standard clamp for Crown trucks with round OHG.

Support Tools & Parts



**External Power Supply**

Part Number - 390001

Allows the InfoLink module to be plugged into a 110V outlet for configuration and troubleshooting.



**Power Management Module**

Part Number - 008279

Used to power an InfoLink module on a non-Crown IC truck with a 12V starter battery.

**Strobe & Alarm**

Part Number - 157208-002

Optional audible alarm and strobe can be activated when impacts occur; to increase operator awareness and safety.

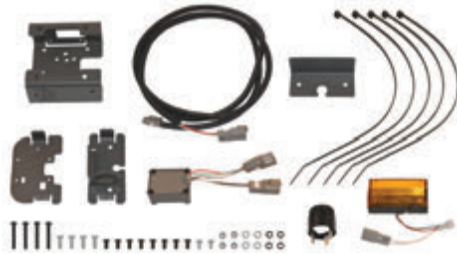

**Impact Sensor**

Part Number - 164432

Used with InfoLink to detect impacts to equipment.



**Peak Dongle**

Part Number - 062915-00S

Cable used to program InfoLink modules using a laptop and appropriate software.

**Crown is Your One-Stop Shop**



**Personal Protective Equipment**

**Fall Protection Equipment**

Including harnesses and lanyards

**Safety Apparel**

Including ear and eye protection, face shields, safety vests, coveralls and hard hats

**Respiratory Equipment**

Including respirators and masks

**Seat Belts**

Including retractable belts, high visibility safety orange and standard color belts in a variety of lengths and styles

**First Aid Kits**

Including those for minor injuries and high risk work zones

See Safety Equipment Section



# Crown PTH 50 Series Pallet Truck

## Features

- Crown Built Durability
- 5000 lb Capacity
- 2.9" Lowered Height - Pallet entry is a non-issue even on non-standard pallets
- Articulated Steer Wheels ensure continual contact with the floor
- Low Rolling Resistance provides longer wear on wheels and bearings
- Dual Entry/Exit System ensures the PTH will virtually glide in and out of any pallet
- Box Section Style Push Rods are stronger than the competitions
- C-Channel Formed Steel Forks designed for maximum strength
- Ergonomic Handle and only a few strokes results in 5" of lift
- Less service, more use - uses sealed bearings and bushings, only one grease zerker

Order Online:  
**crown.com**



## Specifications

| Base Part Number | Width (in) | Dim A Fork Length (in) | Standard w/Poly Tire | Skid Adapter w/Poly Tire | 48" Load Backrest w/Poly Tire | 60" Load Backrest w/Poly Tire | Standard w/Nylon Tire | Load Tray w/ Poly Tire | Tandem w/ Poly Tire | Tandem w/ Nylon Tire | Dim B Load Wheel Lowered | Dim C Load Wheel Raised | Weight (lb) |
|------------------|------------|------------------------|----------------------|--------------------------|-------------------------------|-------------------------------|-----------------------|------------------------|---------------------|----------------------|--------------------------|-------------------------|-------------|
| PTH50-016-36     | 15.8       | 36                     | -1                   | -2                       |                               |                               | -5                    |                        | -8                  | -9                   | 29.5"                    | 23.5"                   | 132         |
| PTH50-018-42     | 17.7       | 42                     | -1                   | -2                       |                               |                               | -5                    |                        | -8                  | -9                   | 35.5"                    | 29.5"                   | 141         |
| PTH50-018-48     | 17.7       | 48                     | -1                   | -2                       |                               |                               | -5                    |                        | -8                  | -9                   | 41.5"                    | 35.5"                   | 148         |
| PTH50-020-36     | 20.5       | 36                     | -1                   | -2                       |                               |                               | -5                    |                        | -8                  | -9                   | 29.5"                    | 23.5"                   | 137         |
| PTH50-020-42     | 20.5       | 42                     | -1                   | -2                       |                               |                               | -5                    |                        | -8                  | -9                   | 35.5"                    | 29.5"                   | 143         |
| PTH50-020-48     | 20.5       | 48                     | -1                   | -2                       |                               |                               | -5                    |                        | -8                  | -9                   | 41.5"                    | 35.5"                   | 150         |
| PTH50-027-32     | 27         | 32                     | -1                   | -2                       | -3                            | -4                            | -5                    | -7                     | -8                  | -9                   | 25.5"                    | 19.5"                   | 139         |
| PTH50-027-36     | 27         | 36                     | -1                   | -2                       | -3                            | -4                            | -5                    | -7                     | -8                  | -9                   | 29.5"                    | 23.5"                   | 143         |
| PTH50-027-42     | 27         | 42                     | -1                   | -2                       | -3                            | -4                            | -5                    | -7                     | -8                  | -9                   | 35.5"                    | 29.5"                   | 150         |
| PTH50-027-48     | 27         | 48                     | -1                   | -2                       | -3                            | -4                            | -5                    | -7                     | -8                  | -9                   | 41.5"                    | 35.5"                   | 159         |
| PTH50-027-54     | 27         | 54                     | -1                   | -2                       | -3                            | -4                            | -5                    | -7                     | -8                  | -9                   | 47.5"                    | 41.5"                   | 174         |
| PTH50-027-60     | 27         | 60                     | -1                   | -2                       | -3                            | -4                            | -5                    | -7                     | -8                  | -9                   | 53.5"                    | 47.5"                   | 187         |
| PTH50-027-72     | 27         | 72                     | -1                   |                          | -3                            | -4                            | -5                    | -7                     | -8                  | -9                   | 65.5"                    | 59.5"                   | 209         |

Add dash number to base number for complete part number, example PTH50-016-36-1 is a standard truck.

**Note:** Skid Adapters increase lowered height to 5.5" and raised height increases to 10.5". Available on all trucks except PTH50-027-72.

**Note:** Load Backrests are constructed of 5/16" steel and are available in 48" and 60" sizes. Only available on PTH's with a 27" width.

## Replacement Parts

| Item Description  | Part Number |
|---|-------------|
| Load Wheel  | 044507      |
| Load Wheel Bearing  | 065081-020  |
| Load Wheel Assembly   | 044506-101  |
| Steer Wheel - Poly Orange   | 818270      |
| Steer Wheel Bearings, Sealed                                      | 065081-018  |
| Hydraulic Unit  | 150121-001  |
| Seal Kit for Hydraulic Unit                                       | 819934      |
| Handle Assembly   | 144546-012  |
| Piston Retainer Tool - used on Hydraulic Unit to keep spring down | 816908      |
| Steer Wheel Assembly, Poly Sealed (Orange)                        | 818275-101  |
| Steer Wheel Assembly, Nylon Sealed                                | 818275-102  |

**WARNING:** Cancer - [www.P65Warnings.ca.gov](http://www.P65Warnings.ca.gov)

## Dimensions

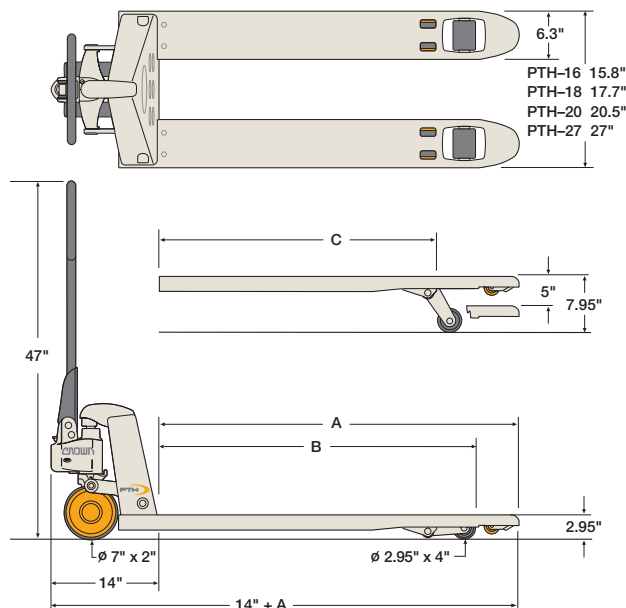

INFOLINK®, PTH 50, CHAIN, FORKS AND ATTACHMENT PARTS

## Crown PTH 50S/PS Series Pallet Truck

**Crown's PTH 50S/PS hand pallet truck with manual or powered scissor lift improves operator comfort and efficiency by avoiding unnecessary bending and lifting that can cause strains and stresses on the body.**

- Use as a hand pallet truck and mobile work positioner
- Handle skids and open-bottom containers
- Transport loads, use as a worktable and feed printing or punch presses, as well as conveyors

### Standard features

- Ergonomic handle
- Three-position control lever (raise, lower and neutral) is easily actuated with one finger
- 200° steer angle for maneuvering in tight areas
- One-piece formed C-channel steel, reinforced forks for maximum strength and longer life
- Heavy-duty, solid steel scissor legs
- Two stabilizer supports disengage the steer wheels at lift height of approximately 15" (400 mm) to prevent unexpected truck movement



| Specifications          | Imperial                    | Metric      | Imperial        | Metric         |
|-------------------------|-----------------------------|-------------|-----------------|----------------|
| Manufacturer            | Crown Equipment Corporation |             |                 |                |
| Scissor Lift Model      | PTH50S                      |             | PTH50PS-1       |                |
| Power, Hydraulic        | Manual                      |             | Manual/Electric |                |
| Load Capacity           | 2200 lbs.                   | 1000 kg     | 2200 lbs.       | 1000 kg        |
| Load Center             | 23.6"                       | 600 mm      | 23.6"           | 600 mm         |
| Fork Length             | 45.3"                       | 1150 mm     | 45.3"           | 1150 mm        |
| Overall Length          | 62.8"                       | 1595 mm     | 65"             | 1650 mm        |
| Outside Fork Spread     | 21.25"/27.0"                | 540/685 mm  | 21.25/27.00"    | 540/685 mm     |
| Fork Width              | 6.3"                        | 160 mm      | 6.3"            | 160 mm         |
| Fork Height Lowered     | 3.35"                       | 85 mm       | 3.35"           | 85 mm          |
| Fork Height Raised      | 31.3"                       | 795 mm      | 31.3"           | 795 mm         |
| Steer Angle             | 200°                        |             | 200°            |                |
| Ground Clearance        | 0.67"                       | 17 mm       | 0.67"           | 17 mm          |
| Poly Steer Wheels       | 7.1" x 2.0"                 | 180 x 50 mm | 7.1" x 2.0"     | 180 mm x 50 mm |
| Poly Load Wheels-Single | 2.9" x 2.95"                | 74 x 75 mm  | 2.9" x 2.95"    | 74 mm x 75 mm  |
| Truck Weight            | 330/348 lbs.                | 150/158 kg  | 429/445 lbs.    | 195/202 kg     |

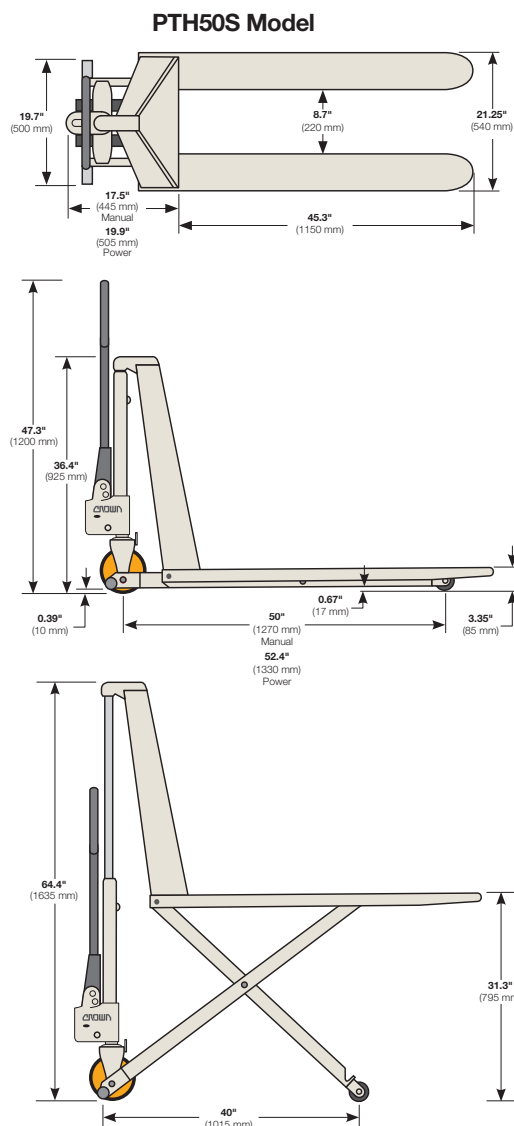

### Replacement Parts

| Item Description      | Part Number |            |
|-----------------------|-------------|------------|
|                       | 50S         | 50PS       |
| Load Wheel            | 044512      | 044512     |
| Steer Wheel - Gray    | 044496      | 044496     |
| Steer Wheel - Orange  | 818270      | 818270     |
| Bearing Load or Steer | 065081-020  | 065081-020 |
| Pump Assembly         | 150124      | 150125     |
| Control Handle        | 143722      | 818106     |
| Control Handle Decal  | 869290      | 869290     |

## Leaf Chain



### Specifications

| Base Number         | Type | Lacing | ANSI Number | Pitch in / mm | Ultimate Strength Minimum lb / kg |
|---------------------|------|--------|-------------|---------------|-----------------------------------|
| 120191*             | B    | 2 x 2  | BL422       | 0.500 / 13    | 5,000 / 2,267                     |
| 090738              | B    | 2 x 3  | BL523       | 0.625 / 16    | 9,000 / 4,082                     |
| 083633              | B    | 3 x 4  | BL534       | 0.625 / 16    | 11,000 / 4,989                    |
| 342908              | B    | 4 X 4  | BL544       | 0.625 / 16    | 15,000 / 6,803                    |
| 342909              | B    | 4 X 6  | BL546       | 0.625 / 16    | 15,000 / 6,803                    |
| 073991              | B    | 3 x 4  | BL634       | 0.750 / 19    | 20,400 / 9,253                    |
| 342907 (was 042907) | B    | 4 x 4  | BL644       | 0.750 / 19    | 26,000 / 11,793                   |
| 103267              | B    | 2 x 2  | BL822       | 1.000 / 25    | 20,500 / 9,298                    |
| 340834              | B    | 3 X 4  | BL834       | 1.000 / 25    | 28,500 / 12,928                   |
| 089260              | B    | 4 x 4  | BL844       | 1.000 / 25    | 40,000 / 18,144                   |

### Order Lengths by Part Number

| Base Number         | 10 ft box  | 15 ft box  | 20 ft box  | 25 ft box   | 28 ft box   |
|---------------------|------------|------------|------------|-------------|-------------|
|                     | 305 cm     | 457 cm     | 610 cm     | 762 cm      | 853 cm      |
| 083633              | 083633-010 | 083633-011 | 083633-012 | 083633-013  |             |
| 342908              | 342908-010 | 342908-015 | 342908-020 |             |             |
| 342909              | 342909-010 | 342909-015 |            |             |             |
| 073991              | 073991-122 | 073991-123 | 073991-124 | 073991-024  | 073991-073  |
| 342907 (was 042907) |            | 342907-015 |            |             |             |
| 103267              | 103267-020 | 103267-021 | 103267-022 |             |             |
| 089260              | 089260-080 | 089260-081 | 089260-082 | 089260-083  |             |
| Base Number         | 30 ft box  | 37 ft box  | 50 ft box  | 100 ft reel | 400 ft reel |
|                     | 914 cm     | 1,128 cm   | 1,524 cm   | 3,048 cm    | 12,192 cm   |
| 083633              |            |            | 083633-014 | 083633-015  |             |
| 342908              |            |            |            | 342908-100  |             |
| 342909              |            |            |            | 342909-100  |             |
| 073991              |            | 073991-076 |            | 073991-100  | 073991-400  |
| 342907 (was 042907) | 342907-030 |            |            | 342907-100  |             |
| 103267              |            |            |            |             |             |
| 340834              |            |            |            | 340834-100  |             |
| 089260              |            |            |            | 089260-085  |             |

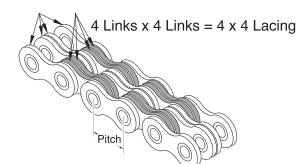
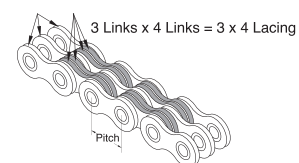
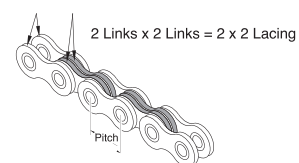

### ► Bulk Order Numbers - 090738-030

Use zinc-plated chain 089260-137 for corrosive environments

\* 120191 sold in lengths -001 92.5", -003 102.5", -004 107.5", -005 56.5"

### Chains Cut to Lengths Available\*

| Part Number | Plate Lacing | ANSI Number | Pitch (Inches) | Tensile Strength (lbs.) | Connecting Link |
|-------------|--------------|-------------|----------------|-------------------------|-----------------|
| 380103-534  | 4x4          | AL644       | 0.75           | 18,000                  |                 |
| 380103-535  | 6x6          | AL866       | 1.00           | 48,100                  | 380101-244      |
| 380103-532  | 6x6          | AL1066      | 1.25           | 69,200                  | 380101-243      |
| 380103-533  | 6x6          | AL1266      | 1.50           | 96,300                  |                 |
| 380103-553  | 2x3          | BL423       | 0.50           | 6,100                   |                 |
| 380103-554  | 4x6          | BL446       | 0.50           | 12,200                  |                 |
| 380103-559  | 6x6          | BL566       | 0.63           | 21,000                  | 380101-255      |
| 380103-560  | 2x2          | BL622       | 0.75           | 12,000                  |                 |
| 380103-561  | 2x3          | BL623       | 0.75           | 13,600                  | 380101-256      |
| 380103-564  | 4x6          | BL646       | 0.75           | 27,200                  | 380101-259      |
| 380103-565  | 6x6          | BL666       | 0.75           | 35,000                  | 380101-260      |
| 380103-567  | 2x3          | BL823       | 1.00           | 23,000                  | 380101-261      |
| 380103-570  | 4x6          | BL846       | 1.00           | 46,100                  | 380101-264      |
| 380103-571  | 6x6          | BL866       | 1.00           | 53,100                  | 380101-244      |
| 380103-537  | 2x3          | BL1023      | 1.25           | 32,100                  |                 |
| 380103-538  | 3x4          | BL1034      | 1.25           | 50,200                  | 380101-245      |
| 380103-539  | 4x4          | BL1044      | 1.25           | 59,000                  |                 |
| 380103-540  | 4x6          | BL1046      | 1.25           | 64,200                  | 380101-246      |
| 380103-541  | 6x6          | BL1066      | 1.25           | 82,200                  | 380101-247      |
| 380103-542  | 3x4          | BL1234      | 1.50           | 66,700                  |                 |
| 380103-544  | 4x6          | BL1246      | 1.50           | 82,300                  |                 |
| 380103-546  | 3x4          | BL1434      | 1.75           | 76,900                  |                 |
| 380103-547  | 4x6          | BL1446      | 1.75           | 104,300                 |                 |

\* Available only to customers in USA

## Roller Chain

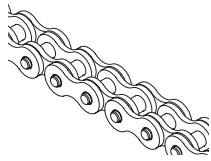

### 077159 Pre-packaged Service Chain Lengths (ANSI Chain Number 40, Pitch 0.5 in/13 mm)

| Part Number | Length |      |        | Packaging | Links | Connecting Links Included |
|-------------|--------|------|--------|-----------|-------|---------------------------|
|             | in     | ft   | cm     |           |       |                           |
| 367159-004  | 47.5   | 3.96 | 120.65 | Bag       | 95    | x                         |
| 367159-005  | 59.5   | 4.96 | 151.13 | Bag       | 119   | x                         |
| 367159-010  | 120    | 10   | 304.8  | Box       | 240   | x                         |
| 367159-100  | 1200   | 100  | 3050   | Reel      | 2400  |                           |

### 078833 Pre-packaged Service Chain Lengths (ANSI Chain Number 50, Pitch 0.6 in/16 mm)

|            |       |      |       |     |    |   |
|------------|-------|------|-------|-----|----|---|
| 078833S002 | 36.87 | 3.08 | 93.66 | Bag | 59 | x |
|------------|-------|------|-------|-----|----|---|

### 132751 Pre-packaged Service Chain Lengths (ANSI Chain Number 80H, Pitch 1.0 in/25.4 mm)

|            |     |    |       |     |     |   |
|------------|-----|----|-------|-----|-----|---|
| 332751-010 | 120 | 10 | 304.8 | Box | 120 | x |
|------------|-----|----|-------|-----|-----|---|

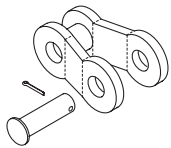

#### Offset Link

| Part Number | ANSI Chain Number | Pitch in / mm |
|-------------|-------------------|---------------|
| 076902-002  | 40                | 0.5 / 13      |
| 076902-004  | 50                | 0.6 / 16      |

#### Chain Wear Scale

Part Number - 106440

Used to check leaf and roller chain wear used for lift and steering functions.

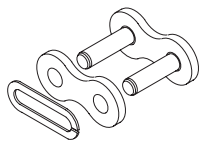

#### Connecting Link

| Part Number | ANSI Chain Number | Pitch in / mm |
|-------------|-------------------|---------------|
| 076902-001  | 40                | 0.5 / 13      |
| 076902-003  | 50                | 0.6 / 16      |
| 076902-005  | 80                | 1.0 / 25      |

#### Did you know?

Highly-stressed precision chains require periodic maintenance to deliver maximum service life. After every 250 hours of truck operation, lift chains should be inspected and lubricated. Inspect chains every 50 hours if in corrosive environment. When chains have elongated 3%, they should be replaced.



#### Premium Chain and Cable Lube

| Part Number | Sales Unit       |
|-------------|------------------|
| 363115-001  | Net wt 11 oz Can |

Superior, non-gumming premium oil that penetrates and lubricates all types of chains and cables. Prevents wear and rust. Loosens rusty nuts. Goes on clean, not running or dripping. Extension tube included.

#### Chain Wear Gauge

Part Number - 306440

Measures chain from 3/8" up to 3" pitch chain; measures wear in % increments; allows user to track wear at each inspection; limits visual errors; easy to follow instructions included.



## Fork Pin Kits



#### 390004-001 Class II

| OEM / Number  | OEM / Number     |
|---------------|------------------|
| CA 7000034    | TY A000009261    |
| CA CCK2PKR-M  | YT 04640-U201071 |
| CA K2PKR-M    | YT 55829000      |
| CL 932775     | YT 055829000     |
| HY 1477241    | YT 504236267     |
| HY 1500773    | YT 522520001     |
| HY 1523735    | YT 580016784     |
| RA 811-885    | YT 580026744     |
| TY A000002859 | YT 580035002     |

#### 390004-002 Class III

| OEM / Number   | OEM / Number  |
|----------------|---------------|
| CA 7000035     | HY 369796     |
| CA CC-K3PKR    | KN K3PKR-M    |
| CA CC-K3PKRM   | KO K3PKR-M    |
| CA CCK480      | KO K3PKR      |
| CA FPK-4736    | KO 8772139    |
| CA K3PKR       | KO 8777178    |
| CA K3PKR-M     | MB A000002860 |
| CA K480        | MB A000009262 |
| CA K485        | NI CK908250   |
| CT A0000-09262 | TY A000002860 |
| CT A000002860  | TY A000009262 |
| CT A000009262  | YT 504236277  |
| CL 908250      | YT 519479802  |
| CL 919405      | YT 522520002  |
| CL 932776      | YT 580016734  |
| HY 0369796     | YT 580016740  |
| HY 1500774     | YT 580035017  |
| HY 1523739     |               |



#### 103442 Class II

| OEM / Number   |
|----------------|
| AC 4933021     |
| BK 101A        |
| CL 999783      |
| HY 3010780     |
| HY 3027923     |
| HY 3131893     |
| RA 811-815-001 |
| SC 31-90210    |
| YT 220015615   |
| YT 220023493   |
| YT 519476805   |

#### 111582 Class III

OEM / Number

|  |
|--|
|  |
|  |
|  |
|  |
|  |
|  |
|  |
|  |
|  |
|  |
|  |
|  |



**Fork Dimensions**

Note: Dimensional diagram applies to all ITA Class II and III forks.

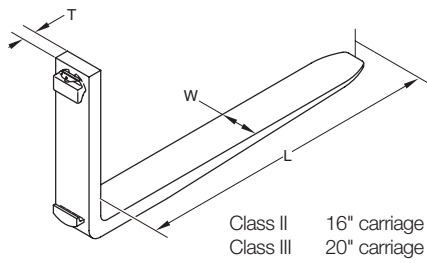

**Partial Taper**

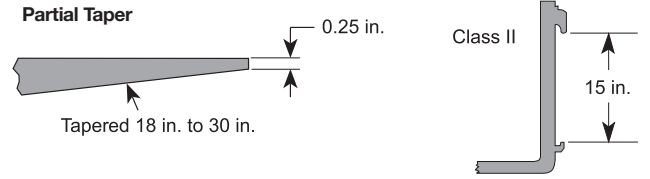

**Full Taper**

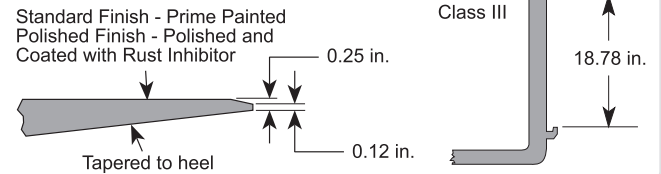

**Did you know?**

Orange fork tip indicators enhance visibility and productivity, while reducing damage potential. Only Crown's are recessed during the forging process which ensures Crown's will last much longer than the painted forks. These forks are fully compliant with ISO and ASME standards.

**Fork Tip Indicator Labels**

P.N. 396538



**Fork Tip Indicator Labels**

P.N. 396539



See Work Assist section for Fork Laser Guides. Available in red or green.



**ITA Class II Forks (Standard Finish, Partial Taper)**

| Dimensions<br>T x W x L - in | Dimensions<br>T x W x L - mm | Capacity<br>lb / kg | Part<br>Number |
|------------------------------|------------------------------|---------------------|----------------|
| 1.5 x 4 x 30                 | 40 x 100 x 760               | 3000 / 1361         | 075324-001     |
| 1.5 x 4 x 36                 | 40 x 100 x 915               | 3000 / 1361         | 075324-002     |
| 1.5 x 4 x 39                 | 40 x 100 x 990               | 3000 / 1361         | 075324-006     |
| 1.5 x 4 x 42                 | 40 x 100 x 1065              | 3000 / 1361         | 075324-003     |
| 1.5 x 4 x 42                 | 40 x 100 x 1065              | 3000 / 1361         | 152758*        |
| 1.5 x 4 x 45                 | 40 x 100 x 1145              | 3000 / 1361         | 075324-005     |
| 1.5 x 4 x 48                 | 40 x 100 x 1220              | 3000 / 1361         | 075324-004     |
| 1.5 x 4 x 54                 | 40 x 100 x 1370              | 3000 / 1361         | 075324-007     |
| 1.5 x 4 x 60                 | 40 x 100 x 1525              | 3000 / 1361         | 075324-008     |
| 1.5 x 4 x 72                 | 40 x 100 x 1829              | 3000 / 1361         | 075324-009     |

**ITA Class II Forks (Polished Finish, Full Taper)**

| Dimensions<br>T x W x L - in | Dimensions<br>T x W x L - mm | Capacity<br>lb / kg | Part<br>Number |
|------------------------------|------------------------------|---------------------|----------------|
| 1.75 x 4 x 30                | 45 x 100 x 760               | 5000 / 2268         | 088228-001     |
| 1.75 x 4 x 31.50             | 45 x 100 x 800               | 5000 / 2268         | 088228-009     |
| 1.75 x 4 x 36                | 45 x 100 x 915               | 5000 / 2268         | 088228-002     |
| 1.75 x 4 x 39                | 45 x 100 x 990               | 5000 / 2268         | 088228-006     |
| 1.75 x 4 x 40                | 45 x 100 x 1015              | 5000 / 2268         | 088228-011     |
| 1.75 x 4 x 42                | 45 x 100 x 1065              | 5000 / 2268         | 088228-003     |
| 1.75 x 4 x 43.31             | 45 x 100 x 1100              | 5000 / 2268         | 088228-010     |
| 1.75 x 4 x 45                | 45 x 100 x 1145              | 5000 / 2268         | 088228-005     |
| 1.75 x 4 x 48                | 45 x 100 x 1220              | 5000 / 2268         | 088228-004     |
| 1.75 x 4 x 54                | 45 x 100 x 1370              | 5000 / 2268         | 088228-007     |
| 1.75 x 4 x 60                | 45 x 100 x 1525              | 5000 / 2268         | 088228-008     |
| 1.75 x 5 x 31.50             | 45 x 130 x 800               | 5500 / 2495         | 106212-009     |
| 1.75 x 5 x 36                | 45 x 130 x 915               | 5500 / 2495         | 106212-002     |
| 1.75 x 5 x 39                | 45 x 130 x 990               | 5500 / 2495         | 106212-007     |
| 1.75 x 5 x 40                | 45 x 130 x 1015              | 5500 / 2495         | 106212-011     |
| 1.75 x 5 x 42                | 45 x 130 x 1065              | 5500 / 2495         | 106212-003     |
| 1.75 x 5 x 43.31             | 45 x 130 x 1100              | 5500 / 2495         | 106212-010     |
| 1.75 x 5 x 45                | 45 x 130 x 1145              | 5500 / 2495         | 106212-008     |
| 1.75 x 5 x 48                | 45 x 130 x 1220              | 5500 / 2495         | 106212-004     |
| 1.75 x 5 x 54                | 45 x 130 x 1370              | 5500 / 2495         | 106212-005     |
| 1.75 x 5 x 60                | 45 x 130 x 1525              | 5500 / 2495         | 106212-006     |

|                  |                 |             |            |
|------------------|-----------------|-------------|------------|
| 1.75 x 4 x 30    | 45 x 100 x 760  | 5000 / 2268 | 094182-001 |
| 1.75 x 4 x 31.50 | 45 x 100 x 800  | 5000 / 2268 | 094182-009 |
| 1.75 x 4 x 36    | 45 x 100 x 915  | 5000 / 2268 | 094182-002 |
| 1.75 x 4 x 39    | 45 x 100 x 990  | 5000 / 2268 | 094182-006 |
| 1.75 x 4 x 40    | 45 x 100 x 1015 | 5000 / 2268 | 094182-011 |
| 1.75 x 4 x 42    | 45 x 100 x 1065 | 5000 / 2268 | 094182-003 |
| 1.75 x 4 x 42    | 45 x 100 x 1065 | 5000 / 2268 | 152759*    |
| 1.75 x 4 x 43.31 | 45 x 130 x 1100 | 5000 / 2268 | 094182-010 |
| 1.75 x 4 x 45    | 45 x 100 x 1145 | 5000 / 2268 | 094182-005 |
| 1.75 x 4 x 48    | 45 x 100 x 1220 | 5000 / 2268 | 094182-004 |
| 1.75 x 4 x 48    | 45 x 100 x 1220 | 5000 / 2268 | 152762*    |
| 1.75 x 4 x 54    | 45 x 100 x 1370 | 5000 / 2268 | 094182-007 |
| 1.75 x 4 x 60    | 45 x 100 x 1525 | 5000 / 2268 | 094182-008 |
| 1.75 x 4 x 72    | 45 x 100 x 1829 | 5000 / 2268 | 094182-012 |

|                  |                 |             |            |
|------------------|-----------------|-------------|------------|
| 1.75 x 5 x 30    | 45 x 130 x 760  | 5500 / 2495 | 106211-001 |
| 1.75 x 5 x 31.50 | 45 x 130 x 800  | 5500 / 2495 | 106211-009 |
| 1.75 x 5 x 36    | 45 x 130 x 915  | 5500 / 2495 | 106211-002 |
| 1.75 x 5 x 39    | 45 x 100 x 990  | 5500 / 2495 | 106211-007 |
| 1.75 x 5 x 42    | 45 x 130 x 1065 | 5500 / 2495 | 106211-003 |
| 1.75 x 5 x 43.31 | 45 x 130 x 1100 | 5500 / 2495 | 106211-010 |
| 1.75 x 5 x 45    | 45 x 130 x 1145 | 5500 / 2495 | 106211-008 |
| 1.75 x 5 x 48    | 45 x 130 x 1220 | 5500 / 2495 | 106211-004 |
| 1.75 x 5 x 54    | 45 x 130 x 1370 | 5500 / 2495 | 106211-005 |
| 1.75 x 5 x 60    | 45 x 130 x 1525 | 5500 / 2495 | 106211-006 |
| 1.75 x 5 x 72    | 45 x 130 x 1829 | 5500 / 2495 | 106211-012 |

\*Do not have fork tip indicators.

**Forks**

**ITA Class III Forks (Polished Finish, Full Taper)**

| Dimensions<br>T x W x L - in | Dimensions<br>T x W x L - mm | Capacity<br>lb / kg | Part Number |
|------------------------------|------------------------------|---------------------|-------------|
| 1.75 x 5 x 31.50             | 45 x 130 x 800               | 6000 / 2722         | 106214-009  |
| 1.75 x 5 x 36                | 45 x 130 x 915               | 6000 / 2722         | 106214-002  |
| 1.75 x 5 x 39                | 45 x 130 x 990               | 6000 / 2722         | 106214-007  |
| 1.75 x 5 x 40                | 45 x 130 x 1015              | 6000 / 2722         | 106214-011  |
| 1.75 x 5 x 42                | 45 x 130 x 1065              | 6000 / 2722         | 106214-003  |
| 1.75 x 5 x 43.31             | 45 x 130 x 1100              | 6000 / 2722         | 106214-010  |
| 1.75 x 5 x 45                | 45 x 130 x 1145              | 6000 / 2722         | 106214-008  |
| 1.75 x 5 x 48                | 45 x 130 x 1220              | 6000 / 2722         | 106214-004  |
| 1.75 x 5 x 54                | 45 x 130 x 1370              | 6000 / 2722         | 106214-005  |
| 1.75 x 5 x 60                | 45 x 130 x 1525              | 6000 / 2722         | 106214-006  |
| 1.75 x 5 x 36                | 45 x 122 x 915               | 6500 / 2948         | 147262-002* |
| 1.75 x 5 x 42                | 45 x 122 x 1065              | 6500 / 2948         | 147262-003* |
| 1.75 x 5 x 48                | 45 x 122 x 1220              | 6500 / 2948         | 147262-004* |
| 1.75 x 5 x 60                | 45 x 122 x 1525              | 6500 / 2948         | 147262-006* |

**ITA Class III Forks (Standard Finish, Partial Taper)**

| Dimensions<br>T x W x L - in | Dimensions<br>T x W x L - mm | Capacity<br>lb / kg | Part Number |
|------------------------------|------------------------------|---------------------|-------------|
| 1.75 x 5 x 31.5              | 45 x 130 x 800               | 6000 / 2722         | 106213-009  |
| 1.75 x 5 x 36                | 45 x 130 x 915               | 6000 / 2722         | 106213-002  |
| 1.75 x 5 x 39                | 45 x 130 x 990               | 6000 / 2722         | 106213-007  |
| 1.75 x 5 x 40                | 45 x 130 x 1015              | 6000 / 2722         | 106213-011  |
| 1.75 x 5 x 42                | 45 x 130 x 1065              | 6000 / 2722         | 106213-003  |
| 1.75 x 5 x 43.31             | 45 x 130 x 1100              | 6000 / 2722         | 106213-010  |
| 1.75 x 5 x 45                | 45 x 130 x 1145              | 6000 / 2722         | 106213-008  |
| 1.75 x 5 x 48                | 45 x 130 x 1220              | 6000 / 2722         | 106213-004  |
| 1.75 x 5 x 54                | 45 x 130 x 1370              | 6000 / 2722         | 106213-005  |
| 1.75 x 5 x 60                | 45 x 130 x 1525              | 6000 / 2722         | 106213-006  |
| 1.75 x 5 x 72                | 45 x 130 x 1830              | 6000 / 2722         | 106213-012  |
| 1.75 x 5 x 36                | 45 x 122 x 915               | 6500 / 2948         | 147261-002* |
| 1.75 x 5 x 42                | 45 x 122 x 1065              | 6500 / 2948         | 147261-003* |
| 1.75 x 5 x 48                | 45 x 122 x 1220              | 6500 / 2948         | 147261-004* |
| 1.75 x 5 x 60                | 45 x 122 x 1525              | 6500 / 2948         | 147261-006* |

\* Do Not Have Fork Tip Indicators

**Fork Dimensions**

Note: Dimensional diagram applies to all Stockpicker forks.

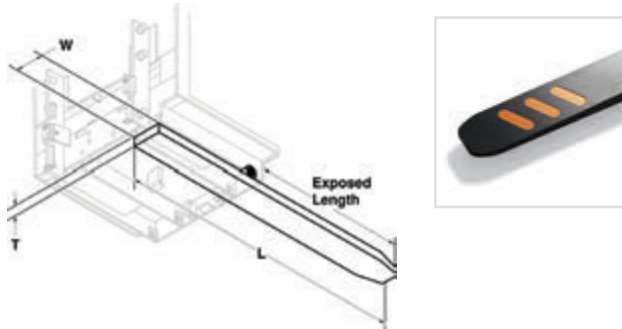

**TS Forks**

| Dimensions<br>T x W x L - in | Dimensions<br>T x W x L - mm | Part Number |
|------------------------------|------------------------------|-------------|
| 2 x 4 x 30                   | 50 x 100 x 760               | 089883-001  |
| 2 x 4 x 36                   | 50 x 100 x 915               | 089883-002  |
| 2 x 4 x 37.40                | 50 x 100 x 950               | 089883-015  |
| 2 x 4 x 42                   | 50 x 100 x 1065              | 089883-005  |
| 2 x 4 x 45.28                | 50 x 100 x 1150              | 089883-016  |
| 2 x 4 x 48                   | 50 x 100 x 1220              | 089883-008  |

Note: Order in pairs. Does not include mounting hardware.

**TSP/TSP 6000, 6500, 7000 Forks**

| Dimensions<br>T x W x L - in | Dimensions<br>T x W x L - mm | Part Number |
|------------------------------|------------------------------|-------------|
| 1.75 x 4 x 30                | 44 x 102 x 760               | 108617-014  |
| 1.75 x 4 x 36                | 44 x 102 x 915               | 108617-004  |
| 1.75 x 4 x 37.40             | 44 x 102 x 950               | 108617-015  |
| 1.75 x 4 x 42                | 44 x 102 x 1065              | 108617-005  |
| 1.75 x 4 x 45.28             | 44 x 102 x 1150              | 108617-016  |
| 1.75 x 4 x 48                | 44 x 102 x 1220              | 108617-006  |

**Stockpickers Manufactured (1986 to Present)**

| Dimensions<br>T x W x L - in | Dimensions<br>T x W x L - mm | Exposed Length<br>in / mm | Part Number |
|------------------------------|------------------------------|---------------------------|-------------|
| 2 x 4 x 60.5                 | 50 x 100 x 1540              | 30 / 760                  | 102476-001  |
| 2 x 4 x 66.5                 | 50 x 100 x 1690              | 36 / 915                  | 102476-002  |
| 2 x 4 x 69.5                 | 50 x 100 x 1765              | 39 / 990                  | 102476-010  |
| 2 x 4 x 72.5                 | 50 x 100 x 1840              | 42 / 1070                 | 102476-003  |
| 2 x 4 x 75.5                 | 50 x 100 x 1920              | 45 / 1145                 | 102476-009  |
| 2 x 4 x 78.5                 | 50 x 100 x 1995              | 48 / 1220                 | 102476-004  |
| 2 x 4 x 84.5                 | 50 x 100 x 2145              | 54 / 1370                 | 102476-005  |
| 2 x 4 x 90.5                 | 50 x 100 x 2300              | 60 / 1525                 | 102476-006  |
| 2 x 4 x 102.5                | 50 x 100 x 2605              | 72 / 1830                 | 102476-007  |
| 2 x 4 x 114.5                | 50 x 100 x 2910              | 84 / 2135                 | 102476-008  |

**Did you know?**

OSHA states that forks worn beyond 10% of their original thickness should not be returned to service.



**Fork Wear Calipers**

Part Number - 107330

Used to gauge minimum fork thickness and maximum bore size.

**Stockpicker Tubular Forks** (Use with Platform Load Decks)

| Dimensions<br>T x W x L - in | Dimensions<br>T x W x L - mm | Exposed Length<br>in / mm | Part Number |
|------------------------------|------------------------------|---------------------------|-------------|
| 3 x 6 x 114                  | 76 x 152 x 2900              | 84 / 2135                 | 141114-001  |

Note: Order in pairs. Does not include mounting hardware.

**Sideshift Label**

Part Number - 069986

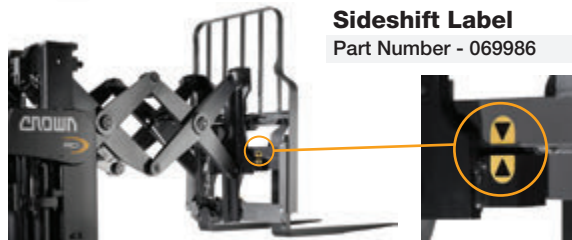

## Fork Extensions

| Part Number*                           | Description | Weight   |
|--|-------------|----------|
| <b>4" Wide Fork Extensions (Pair)*</b> |             |          |
| 360039-008                             | 54" Loop    | 83 lbs.  |
| 360039-009                             | 54" Pin     | 83 lbs.  |
| 360039-010                             | 63" Loop    | 97 lbs.  |
| 360039-011                             | 63" Pin     | 97 lbs.  |
| 360039-012                             | 72" Loop    | 113 lbs. |
| 360039-013                             | 72" Pin     | 113 lbs. |
| 360039-014                             | 84" Loop    | 130 lbs. |
| 360039-015                             | 84" Pin     | 132 lbs. |
| 360039-016                             | 96" Loop    | 149 lbs. |
| 360039-017                             | 96" Pin     | 151 lbs. |

| Part Number*                           | Description | Weight   |
|--|-------------|----------|
| <b>5" Wide Fork Extensions (Pair)*</b> |             |          |
| 360039-018                             | 54" Loop    | 92 lbs.  |
| 360039-019                             | 54" Pin     | 94 lbs.  |
| 360039-020                             | 63" Loop    | 108 lbs. |
| 360039-021                             | 63" Pin     | 110 lbs. |
| 360039-022                             | 72" Loop    | 123 lbs. |
| 360039-023                             | 72" Pin     | 126 lbs. |
| 360039-024                             | 84" Loop    | 144 lbs. |
| 360039-025                             | 84" Pin     | 146 lbs. |
| 360039-026                             | 96" Loop    | 165 lbs. |
| 360039-027                             | 96" Pin     | 167 lbs. |

| Part Number*                           | Description | Weight   |
|--|-------------|----------|
| <b>6" Wide Fork Extensions (Pair)*</b> |             |          |
| 360039-028                             | 54" Loop    | 104 lbs. |
| 360039-029                             | 54" Pin     | 104 lbs. |
| 360039-030                             | 63" Loop    | 116 lbs. |
| 360039-031                             | 63" Pin     | 116 lbs. |
| 360039-032                             | 72" Loop    | 134 lbs. |
| 360039-033                             | 72" Pin     | 134 lbs. |
| 360039-034                             | 84" Loop    | 163 lbs. |
| 360039-035                             | 84" Pin     | 165 lbs. |
| 360039-036                             | 96" Loop    | 186 lbs. |
| 360039-037                             | 96" Pin     | 188 lbs. |

**Replacement Parts for Pin Styled Fork Extenders**

|             |            |
|-------------|------------|
| 360039-7252 | Lock Pin   |
| 360039-7253 | Cotter Pin |

**\*Available only to customers in USA**

Fork extensions are lift truck attachments that increase the fork's effective length for handling oversized uniformly distributed loads. When installed, fork extensions influence the truck's capacity and therefore in accordance with the law – OSHA 1910.178, the User is to request an authorization from their local dealer for a new capacity plate for their specific truck equipped with fork extensions. Maximum uniform capacity is 4,000 lbs. evenly distributed per pair.

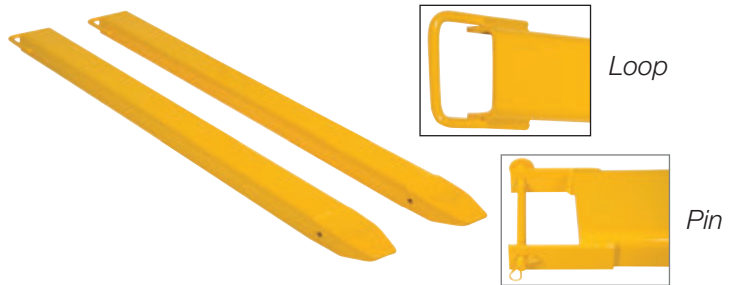

**1910.178(a)(4)**

Modifications and additions which affect capacity and safe operation shall not be performed by the customer or user without manufacturers prior written approval. Capacity, operation, and maintenance instruction plates, tags, or decals shall be changed accordingly.

**1910.178(a)(5)**

If the truck is equipped with front-end attachments other than factory installed attachments, the user shall request that the truck be marked to identify the attachments and show the approximate weight of the truck and attachment combination at maximum elevation with load laterally centered.

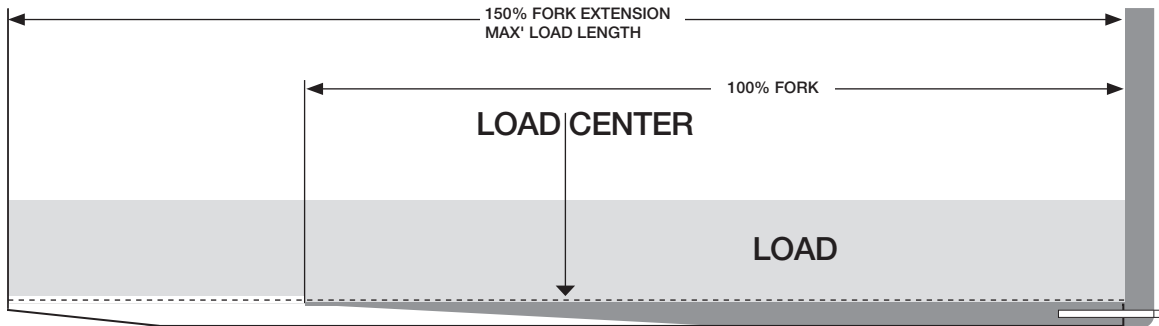

Fork extension length should not be more than 150% of supporting fork length.

## Magnetic Fork Covers

**Slip Resistant Fork Covers for an Assortment of Loads**

- Easy to install and remove
- Black rubber upper layer, a metal inner core and a magnetic bottom layer
- Easily stores on the side of the truck when not in use

| Part Number | Use w/Forks (W x L) | Thickness | Pcs  | Features               |
|-------------|---------------------|-----------|------|------------------------|
| 360037-439  | 4 x 48-54"          | 1/4"      | Pair | Covers Blade and Shank |
| 360037-440  | 5 x 48-54"          | 1/4"      | Pair | Covers Blade and Shank |



## Pallet Protector Pallet Dawg - Bull Dawg ★ NEW!

| Part Number | Description | Weight     |
|-------------|-------------|------------|
| 351098-001  | Pallet Dawg | 4.825 lbs. |
| 351098-002  | Bull Dawg   | 5.335 lbs  |

**Reduce Pallet and Product Damage** — When damaged pallets enter your warehouse, Pallet Dawg and Bull Dawg help prevent incidental forklift contact with product. Companies that utilize these pallet protectors realize significant savings by extending the usable life of their pallets and dock equipment while reducing damage, waste and rework.



**Pallet Dawg**  
P.N. 351098-001

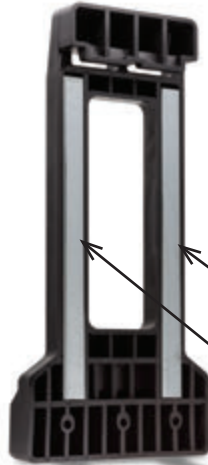

**Bull Dawg**  
P.N. 351098-002

Reinforced with two galvanized steel bars along each side

- Uni-body, molded construction — flexible yet rugged
- Slim, lightweight design
- Large window area — increased visibility enhances safety and convenience
- Narrow impact zone — reduce the chance for contact with product
- Beveled, contoured edges - smooth surfaces and rounded corners contact product gently
- Large radius connecting plate — rounded design enables the carriage to glide over dock plates and rack systems
- Easy assembly — three bolts and one tool
- Fits like a glove — engineered to fit **Class II carriages**
- Durable and corrosion proof — PVC plastic withstands extreme environments

### Bull Dawg

- Same look and installation as the **Pallet Dawg**, the only difference is two galvanized steel bars along each side
- Ideal for high-impact and rigorous applications
- Super tough in severe cold environments

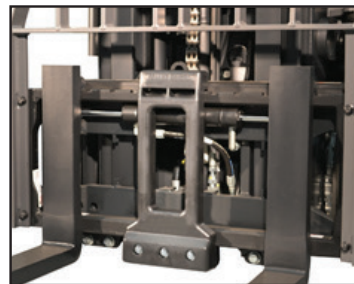
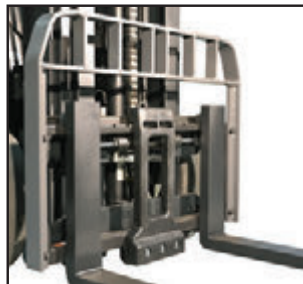

These devices will increase the horizontal load center dimension shown on the forklifts capacity plate. Crown recommends contacting the factory for an updated capacity plate. On Crown products, the Pallet Dawg and Bull Dawg will decrease the rated capacity approximately 50-100 lb. (25-50kg).

**Major Components**



**Arm**  
 Part Number - 360036-243  
 ▼ OEM Reference  
 CA 204604



**Frame**  
 Part Number - 360036-237  
 ▼ OEM Reference  
 CA 6018494



**Frame**  
 Part Number - 360036-572  
 ▼ OEM Reference  
 CA 6056651

**Contact Pads & Wear Strips**

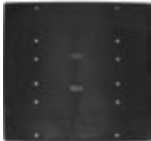

**Contact Pad**  
 Part Number - 360036-144  
 Used on 15D & 25D Series Carton Clamps  
 ▼ OEM Reference  
 CA 6057565



**Contact Pad**  
 Part Number - 360036-062  
 Used on 15D & 25D Series Carton Clamps  
 ▼ OEM Reference  
 CA 222703



**Contact Pad**  
 Part Number - 360036-170  
 Used on 40D Series TurnAFork  
 ▼ OEM Reference  
 CA 669712



**Contact Pad**  
 Part Number - 360036-024  
 Used on 15D, 25D, & 30E Series Carton Clamps  
 ▼ OEM Reference  
 CA 221510



**Contact Pad**  
 Part Number - 360036-114  
 Used on 15D & 25D Series Carton Clamps  
 ▼ OEM Reference  
 CA 6057565



**Contact Pad**  
 Part Number - 360036-143  
 Used on AED Special Design Unit  
 ▼ OEM Reference  
 CA 222369



**Rubber Wear Strip**  
 Part Number - 360036-162  
 ▼ OEM Reference  
 CA 6014935



**Rubber Wear Strip**  
 Part Number - 360036-257  
 ▼ OEM Reference  
 CA 6091922



**Wear Strip**  
 Part Number - 360036-258  
 ▼ OEM Reference  
 CA 379439



**Pad - Gripper**  
 Part Number - 360036-018  
 ▼ OEM Reference  
 CA 672712

**Hooks**



**Hook**  
 Part Number - 360036-029  
 ▼ OEM Reference  
 CA 675514



**Hook Lower**  
 Part Number - 116875  
 ▼ OEM Reference  
 CA 204186

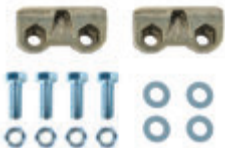

**Lower Bronze Hook**  
 Part Number - 390002-002  
 ▼ OEM Reference  
 CA 228165

**Cylinders & Seal Kits**



**Cylinder**  
Part Number - 360036-182  
▼ OEM Reference  
CA 671573



**Cylinder**  
Part Number - 360036-241  
▼ OEM Reference  
CA 671570



**Cylinder Assembly  
Cascade 34.5, 38**  
Part Number - 126841-001  
▼ OEM Reference  
CA 6025684



**Cylinder Assembly  
Cascade 44**  
Part Number - 126841-002  
▼ OEM Reference  
CA 6025686



**Reel Hose**  
Part Number - 105500  
▼ OEM Reference  
CA 679534

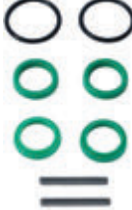

**Rod Seal Service Kit**  
Part Number - 126903  
▼ OEM Reference  
CA 219868

**Bearings**



**Bearing Guide**  
Part Number - 390002-009  
▼ OEM Reference  
CA 667663



**Lower Bearing**  
Part Number - 390002-007  
▼ OEM Reference  
CA 208858



**Lower Bearing  
Composite**  
Part Number - 131990  
▼ OEM Reference  
CA 6033487



**Upper/Lower Bearing Kit**  
Part Number - 390002-008  
▼ OEM Reference  
CA 681749



**Upper Bearing**  
Part Number - 390002-006  
▼ OEM Reference  
CA 208857



**Upper Bearing Composite**  
Part Number - 131989  
▼ OEM Reference  
CA 6020486

**Hardware**



**Bell Crank Assembly**  
Part Number - 360036-461  
▼ OEM Reference  
CA 672043



**Bushing**  
Part Number - 360036-009  
▼ OEM Reference  
CA 200590



**Pin**  
Part Number - 360036-014  
▼ OEM Reference  
CA 210161



**Pin**  
Part Number - 360036-004  
▼ OEM Reference  
CA 678832



**Eye Pin**  
Part Number - 360036-003  
▼ OEM Reference  
CA 6020429



**Pop Rivet**  
Part Number - 360036-010  
▼ OEM Reference  
CA 667843

## Cascade OEM Parts

### Hardware (continued)



#### Capscrew

Part Number - 360036-001

▼ OEM Reference  
CA 768706



#### Capscrew

Part Number - 360036-049

▼ OEM Reference  
CA 211180



#### Capscrew

Part Number - 360036-017

▼ OEM Reference  
CA 200173



#### Capscrew

Part Number - 360036-090

▼ OEM Reference  
CA 684659



#### Capscrew

Part Number - 360036-007

▼ OEM Reference  
CA 4674



#### Capscrew

Part Number - 360036-052

▼ OEM Reference  
CA 200504



#### Capscrew

Part Number - 360036-044

▼ OEM Reference  
CA 787372



#### Capscrew

Part Number - 360036-005

▼ OEM Reference  
CA 787375



#### Locknut

Part Number - 360036-006

▼ OEM Reference  
CA 550218



#### Nut

Part Number - 360036-015

▼ OEM Reference  
CA 683170



#### Nut

Part Number - 094004

▼ OEM Reference  
CA 553857



#### Nut

Part Number - 360036-002

▼ OEM Reference  
CA 773842



#### Washer

Part Number - 116876

▼ OEM Reference  
CA 667225



#### Washer

Part Number - 360036-092

▼ OEM Reference  
CA 667910



#### Washer

Part Number - 360036-011

▼ OEM Reference  
CA 675620



#### Washer

Part Number - 360036-081

▼ OEM Reference  
CA 787398

### Decals



#### Warning Decal

Part Number - 146788

▼ OEM Reference  
CA 221906



#### Label Service Cascade SS

Part Number - 069865

▼ OEM Reference  
CA 228818

**Note:** More Cascade parts available; contact your dealer.

**ITA Class II (Partial Taper)**

| Dimensions<br>L x W x T - in | Dimensions<br>L x W x T - mm | Part<br>Number |
|------------------------------|------------------------------|----------------|
| 30 x 4 x 1.5                 | 760 x 100 x 38               | 157212-001     |
| 36 x 4 x 1.5                 | 915 x 100 x 38               | 157212-002     |
| 39 x 4 x 1.5                 | 990 x 100 x 38               | 157212-003     |
| 42 x 4 x 1.5                 | 1065 x 100 x 38              | 157212-004     |
| 45 x 4 x 1.5                 | 1145 x 100 x 38              | 157212-005     |
| 48 x 4 x 1.5                 | 1220 x 100 x 38              | 157212-006     |
| 54 x 4 x 1.5                 | 1370 x 100 x 38              | 157212-007     |
| 60 x 4 x 1.5                 | 1525 x 100 x 38              | 157212-008     |
| 30 x 4 x 1.75                | 760 x 100 x 45               | 157212-009     |
| 36 x 4 x 1.75                | 915 x 100 x 45               | 157212-010     |
| 39 x 4 x 1.75                | 990 x 100 x 45               | 157212-011     |
| 42 x 4 x 1.75                | 1065 x 100 x 45              | 157212-012     |
| 45 x 4 x 1.75                | 1145 x 100 x 45              | 157212-013     |
| 48 x 4 x 1.75                | 1220 x 100 x 45              | 157212-014     |
| 54 x 4 x 1.75                | 1370 x 100 x 45              | 157212-015     |
| 60 x 4 x 1.75                | 1525 x 100 x 45              | 157212-016     |
| 30 x 5 x 1.75                | 760 x 130 x 45               | 157212-025     |
| 36 x 5 x 1.75                | 915 x 130 x 45               | 157212-026     |
| 39 x 5 x 1.75                | 990 x 130 x 45               | 157212-027     |
| 42 x 5 x 1.75                | 1065 x 130 x 45              | 157212-028     |
| 45 x 5 x 1.75                | 1145 x 130 x 45              | 157212-029     |
| 48 x 5 x 1.75                | 1220 x 130 x 45              | 157212-030     |
| 54 x 5 x 1.75                | 1370 x 130 x 45              | 157212-031     |
| 60 x 5 x 1.75                | 1525 x 130 x 45              | 157212-032     |

**ITA Class II (Full Taper)**

| Dimensions<br>L x W x T - in | Dimensions<br>L x W x T - mm | Part<br>Number |
|------------------------------|------------------------------|----------------|
| 30 x 4 x 1.75                | 760 x 100 x 45               | 157212-017     |
| 36 x 4 x 1.75                | 915 x 100 x 45               | 157212-018     |
| 39 x 4 x 1.75                | 990 x 100 x 45               | 157212-019     |
| 42 x 4 x 1.75                | 1065 x 100 x 45              | 157212-020     |
| 45 x 4 x 1.75                | 1145 x 100 x 45              | 157212-021     |
| 48 x 4 x 1.75                | 1220 x 100 x 45              | 157212-022     |
| 54 x 4 x 1.75                | 1370 x 100 x 45              | 157212-023     |
| 60 x 4 x 1.75                | 1525 x 100 x 45              | 157212-024     |
| 30 x 5 x 1.75                | 760 x 130 x 45               | 157212-033     |
| 36 x 5 x 1.75                | 915 x 130 x 45               | 157212-034     |
| 39 x 5 x 1.75                | 990 x 130 x 45               | 157212-035     |
| 42 x 5 x 1.75                | 1065 x 130 x 45              | 157212-036     |
| 45 x 5 x 1.75                | 1145 x 130 x 45              | 157212-037     |
| 48 x 5 x 1.75                | 1220 x 130 x 45              | 157212-038     |
| 54 x 5 x 1.75                | 1370 x 130 x 45              | 157212-039     |
| 60 x 5 x 1.75                | 1525 x 130 x 45              | 157212-040     |

**ITA Class III (Partial Taper)**

| Dimensions<br>L x W x T - in | Dimensions<br>L x W x T - mm | Part<br>Number |
|------------------------------|------------------------------|----------------|
| 30 x 5 x 1.75                | 760 x 130 x 45               | 157212-041     |
| 36 x 5 x 1.75                | 915 x 130 x 45               | 157212-042     |
| 39 x 5 x 1.75                | 990 x 130 x 45               | 157212-043     |
| 42 x 5 x 1.75                | 1065 x 130 x 45              | 157212-044     |
| 45 x 5 x 1.75                | 1145 x 130 x 45              | 157212-045     |
| 48 x 5 x 1.75                | 1120 x 130 x 45              | 157212-046     |
| 54 x 5 x 1.75                | 1370 x 130 x 45              | 157212-047     |
| 60 x 5 x 1.75                | 1525 x 130 x 45              | 157212-048     |

**ITA Class III (Full Taper)**

| Dimensions<br>L x W x T - in | Dimensions<br>L x W x T - mm | Part<br>Number |
|------------------------------|------------------------------|----------------|
| 30 x 5 x 1.75                | 760 x 130 x 45               | 157212-049     |
| 36 x 5 x 1.75                | 915 x 130 x 45               | 157212-050     |
| 39 x 5 x 1.75                | 990 x 130 x 45               | 157212-051     |
| 42 x 5 x 1.75                | 1065 x 130 x 45              | 157212-052     |
| 45 x 5 x 1.75                | 1145 x 130 x 45              | 157212-053     |
| 48 x 5 x 1.75                | 1220 x 130 x 45              | 157212-054     |
| 54 x 5 x 1.75                | 1370 x 130 x 45              | 157212-055     |
| 60 x 5 x 1.75                | 1525 x 130 x 45              | 157212-056     |

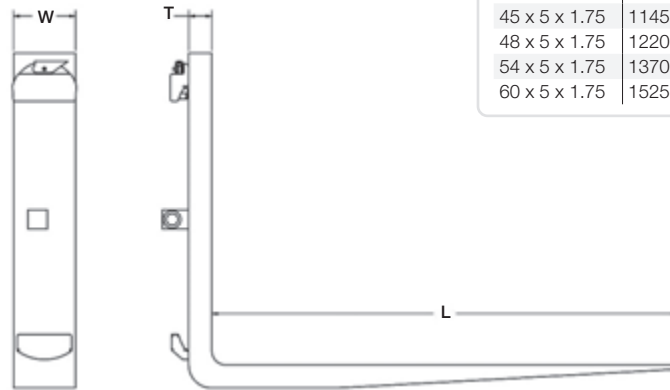

**Now Available:**



No Entry Beyond  
This Point  
Floor Sign

See Page 3.09



Orange Knit Cap  
with LED Light

See Page 2.12



Hand  
Sanitizer

See Page 1.07





| Rightline Part Number | Crown Part No. | Description     |
|-----------------------|----------------|-----------------|
| 004-184-040           | 156029         | Plate           |
| 004-216               | 156022         | Plate           |
| 004-219-125           | 156004         | Plate           |
| 004-439-001           | 155999         | Plate           |
| 004-495-001           | 155844         | Plate           |
| 004-596-001           | 155677         | Plate           |
| 004-619-001           | 155666         | Plate           |
| 005-007-001           | 156021         | Retainer        |
| 005-206-001           | 155861         | Retainer        |
| 005-210-001           | 155782         | ITA Slide       |
| 005-304-001           | 155922         | ITA Slide       |
| 005-306-001           | 155940         | Retainer        |
| 006-130-001           | 155661         | Hook            |
| 010-057-001           | 155667         | Retainer        |
| 020-038-002           | 155961         | Poly Bearing    |
| 020-038-004           | 155959         | Poly Bearing    |
| 020-043-001           | 155783         | Poly Bearing    |
| 020-078-001           | 156000         | Poly Bearing    |
| 020-079-002           | 156001         | Poly Bearing    |
| 032-063-001           | 155625         | Plate           |
| 041-001               | 156020         | Shim            |
| 041-022-001           | 155860         | Shim            |
| 044-049-013           | 155978         | Pin             |
| 044-067-001           | 155665         | Pin             |
| 044-083-001           | 156017         | Pin             |
| 044-084-001           | 156016         | Pin             |
| 044-104-001           | 155676         | Pin             |
| 046-041-001           | 155964         | Bushing         |
| 050-001-075           | 155815         | Spacer          |
| 052-156-007           | 155976         | Fork Weldment   |
| 052-157-007           | 155977         | Fork Weldment   |
| 061-097-001           | 155996         | Hook Assembly   |
| 101-201-001           | 155786         | Cylinder Anchor |
| 101-279-001           | 155998         | Cylinder Anchor |
| 101-309-X344          | 155781         | Cylinder Anchor |
| 101-309-X408          | 155869         | Cylinder Anchor |
| 101-309-X496          | 156005         | Cylinder Anchor |
| 101-309-X620          | 156170         | Cylinder Anchor |
| 101-313-X416Y33       | 155921         | Cylinder Anchor |
| 101-313-X512Y33       | 155946         | Cylinder Anchor |
| 101-313-X592Y33       | 156180         | Cylinder Anchor |
| 103-107-001           | 155789         | Cylinder Tube   |
| 103-109-001           | 155924         | Cylinder Tube   |
| 104-057-106           | 155968         | Cylinder Rod    |
| 104-060-003           | 155795         | Cylinder Rod    |
| 104-106-015           | 156009         | Cylinder Rod    |
| 104-120-194           | 155807         | Cylinder Rod    |
| 104-120-218           | 155931         | Cylinder Rod    |
| 104-120-222           | 155871         | Cylinder Rod    |
| 104-120-266           | 155948         | Cylinder Rod    |
| 104-120-270           | 155878         | Cylinder Rod    |
| 104-120-338           | 156183         | Cylinder Rod    |
| 104-120-342           | 156173         | Cylinder Rod    |
| 105-002-001           | 156012         | Cylinder Piston |
| 105-040-001           | 155969         | Cylinder Piston |
| 105-064-001           | 155791         | Cylinder Piston |
| 105-065-001           | 155816         | Cylinder Piston |
| 105-066-001           | 155926         | Cylinder Piston |
| 106-016               | 155966         | Cylinder Head   |
| 106-022-001           | 156010         | Cylinder Head   |
| 106-074-001           | 155794         | Cylinder Head   |
| 106-074-002           | 155793         | Cylinder Head   |
| 106-075-001           | 155813         | Cylinder Head   |
| 106-076-001           | 155929         | Cylinder Head   |
| 106-076-002           | 155928         | Cylinder Head   |
| 108-119-005           | 156013         | Cylinder Tube   |
| 108-122-001           | 155970         | Cylinder Tube   |
| 108-141-194           | 155810         | Tube Assembly   |
| 108-141-218           | 155932         | Tube Assembly   |
| 108-141-222           | 155872         | Tube Assembly   |
| 108-141-266           | 155949         | Tube Assembly   |

| Rightline Part Number | Crown Part No. | Description            |
|-----------------------|----------------|------------------------|
| 108-141-270           | 155879         | Tube Assembly          |
| 108-141-338           | 156184         | Tube Assembly          |
| 108-141-342           | 156174         | Tube Assembly          |
| 114-001-001           | 155641         | Valve Assembly         |
| 116-239-X548          | 155845         | Hydraulic Group        |
| 116-239-X604          | 155873         | Hydraulic Group        |
| 116-239-X700          | 155867         | Hydraulic Group        |
| 116-239-X844          | 156172         | Hydraulic Group        |
| 116-242-X604          | 155933         | Hydraulic Group        |
| 116-242-X700          | 155950         | Hydraulic Group        |
| 116-242-X844          | 156182         | Hydraulic Group        |
| 116-277-001           | 155984         | Hydraulic Group        |
| 119-100-001           | 155848         | Manifold               |
| 119-119-001           | 155985         | Manifold               |
| 119-122-001           | 155642         | Manifold               |
| 120-049-001           | 155643         | Fitting                |
| 120-049-002           | 155646         | Fitting                |
| 120-049-003           | 155847         | Fitting                |
| 120-050-003           | 155645         | Fitting                |
| 120-050-004           | 155846         | Fitting                |
| 120-050-007           | 155799         | Fitting                |
| 120-051-002           | 155644         | Fitting                |
| 120-059-001           | 155653         | Fitting                |
| 120-065-001           | 155852         | Fitting                |
| 120-070-002           | 156019         | Fitting                |
| 120-080-001           | 155851         | Fitting                |
| 120-087-001           | 155798         | Restrictor Disc        |
| 125-003-001           | 155650         | Cartridge Relief       |
| 125-006-002           | 155986         | Cartridge              |
| 125-007-001           | 155649         | Cartridge Dual Relief  |
| 125-014-001           | 155647         | Cartridge Check Valve  |
| 125-029-001           | 155648         | Cartridge Flow Divider |
| 127-131-010           | 155989         | Hydraulic Hose Group   |
| 130-006-013           | 155657         | Hose Assembly          |
| 130-006-024           | 155990         | Hose                   |
| 130-006-041           | 155994         | Hose                   |
| 130-006-125           | 155656         | Hose Assembly          |
| 130-006-177           | 155658         | Hose Assembly          |
| 130-006-297           | 155993         | Hose                   |
| 130-006-331           | 155655         | Hose Assembly          |
| 130-013-X410          | 155857         | Hose                   |
| 130-013-X438          | 155877         | Hose                   |
| 130-013-X466          | 155938         | Hose                   |
| 130-013-X486          | 155919         | Hose                   |
| 130-013-X514          | 155954         | Hose                   |
| 130-013-X540          | 155855         | Hose                   |
| 130-013-X544          | 155856         | Hose                   |
| 130-013-X558          | 156178         | Hose                   |
| 130-013-X568          | 155875         | Hose                   |
| 130-013-X586          | 156188         | Hose                   |
| 130-013-X590          | 155936         | Hose                   |
| 130-013-X600          | 155876         | Hose                   |
| 130-013-X616          | 155917         | Hose                   |
| 130-013-X620          | 155854         | Hose                   |
| 130-013-X638          | 155952         | Hose                   |
| 130-013-X676          | 155874         | Hose                   |
| 130-013-X688          | 156176         | Hose                   |
| 130-013-X696          | 155918         | Hose                   |
| 130-013-X700          | 155935         | Hose                   |
| 130-013-X710          | 156186         | Hose                   |
| 130-013-X728          | 155953         | Hose                   |
| 130-013-X772          | 155880         | Hose                   |
| 130-013-X796          | 155951         | Hose                   |
| 130-013-X840          | 156177         | Hose                   |
| 130-013-X872          | 156187         | Hose                   |
| 130-013-X916          | 156175         | Hose                   |
| 130-013-X940          | 156185         | Hose                   |
| 130-014-011           | 155934         | Hose                   |
| 130-014-017           | 155853         | Hose                   |
| 130-016-027           | 155991         | Hose                   |
| 130-016-045           | 155992         | Hose                   |

## Rightline Cross Reference

| Rightline Part Number | Crown Part No. | Description           |
|-----------------------|----------------|-----------------------|
| 204-116-001           | 155780         | Fork Positioner Frame |
| 204-116-002           | 155868         | Fork Positioner Frame |
| 204-116-003           | 155801         | Fork Positioner Frame |
| 204-116-004           | 156169         | Fork Positioner Frame |
| 204-117-001           | 155920         | Fork Positioner Frame |
| 204-117-002           | 155945         | Fork Positioner Frame |
| 204-117-003           | 156179         | Fork Positioner Frame |
| 206-117-001           | 155955         | Clamp Base            |
| 206-180-001           | 155770         | Clamp Base            |
| 207-343-009           | 155974         | Fork Arm Weldment     |
| 207-344-009           | 155975         | Fork Arm Weldment     |
| 207-533-005           | 155626         | Arm Weldment          |
| 210-243-005           | 155980         | Backrest RH           |
| 210-244-005           | 155981         | Backrest LH           |
| 210-246-001           | 156026         | Backrest LH           |
| 210-247-001           | 156028         | Backrest RH           |
| 210-265-001           | 155671         | Load Backrest         |
| 217-025-002           | 155674         | Pad Carrier           |
| 217-026-002           | 155675         | Pad Carrier           |
| 219-262-001           | 155939         | Mounting Group        |
| 219-263-001           | 155859         | Mounting Group        |
| 219-276-002           | 155995         | Mounting Group        |
| 219-305-001           | 155664         | Mounting Group QD     |
| 227-019-005           | 155979         | Backrest Group        |
| 227-023-001           | 156025         | Backrest Group        |
| 275-003-001           | 360035-001     | Wiring Harness        |
| 275-010-001           | 360035-002     | Wiring Harness        |
| 401-018-001           | 155960         | Roll Pin              |
| 401-019-002           | 155958         | Roll Pin              |
| 401-023-002           | 155784         | Roll Pin              |
| 402-016-001           | 155865         | Lock Washer           |
| 402-016-002           | 155982         | Lock Washer           |
| 402-016-003           | 156023         | Lock Washer           |
| 402-016-004           | 155785         | Lock Washer           |
| 402-016-005           | 155987         | Lock Washer           |
| 402-016-006           | 155849         | Lock Washer           |
| 402-017-001           | 155651         | Lock Washer           |
| 402-017-004           | 155662         | Lock Washer           |
| 403-028-005           | 155673         | Socket Cap Screw      |
| 403-038-004           | 155678         | Socket Cap Screw      |
| 403-039-006           | 155997         | Socket Cap Screw      |
| 403-039-008           | 155663         | Socket Cap Screw      |
| 405-067-003           | 156024         | Cap Screw             |
| 405-068-001           | 155669         | Cap Screw             |
| 405-068-002           | 155866         | Cap Screw             |
| 405-069-008           | 155983         | Cap Screw             |
| 405-069-012           | 156027         | Cap Screw             |
| 405-072-004           | 155804         | Cap Screw             |
| 405-074-001           | 156006         | Cap Screw             |
| 405-074-004           | 155988         | Cap Screw             |
| 405-074-008           | 156003         | Cap Screw             |
| 405-076-004           | 156007         | Cap Screw             |
| 405-076-005           | 155850         | Cap Screw             |
| 406-023-001           | 155818         | Nut                   |
| 406-023-006           | 155787         | Nut                   |
| 406-023-009           | 155637         | Nut                   |
| 406-024-001           | 155957         | Castle Nut            |
| 406-042-001           | 155624         | Nut                   |
| 407-006-002           | 155956         | Cotter Pin            |
| 408-006-001           | 155803         | Grease Fitting        |
| 411-001-001           | 155659         | Cable Tie             |
| 413-021-001           | 155639         | Bearing               |
| 431-002-001           | 155670         | Protective Cap        |
| 900-014-001           | 156014         | Service Kit           |
| 900-017-001           | 155705         | Service Kit           |
| 900-049-001           | 155973         | Service Kit           |
| 900-054-001           | 155819         | Service Kit           |
| 900-055-001           | 155941         | Service Kit           |
| 900-058-001           | 155800         | Service Kit           |
| C-2Q269               | 155962         | Cylinder              |

| Rightline Part Number | Crown Part No. | Description     |
|-----------------------|----------------|-----------------|
| C-2V194F              | 155806         | Cylinder        |
| C-2V218F              | 155930         | Cylinder        |
| C-2V222F              | 155870         | Cylinder        |
| C-2V266F              | 155947         | Cylinder        |
| C-2V270F              | 155858         | Cylinder        |
| C-2V338F              | 156181         | Cylinder        |
| C-2V342F              | 156171         | Cylinder        |
| C-2Y437               | 155627         | Cylinder        |
| C-3C437               | 155694         | Cylinder        |
| C-635-001             | 155788         | Cylinder        |
| C-642-001             | 155923         | Cylinder        |
| C-683-001             | 156008         | Cylinder        |
| FEM248                | 155759         | Fork Positioner |
| FEM249                | 155760         | Fork Positioner |
| PFG2-18430            | 157212-017     | Fork Assembly   |
| PFG2-18436            | 157212-018     | Fork Assembly   |
| PFG2-18439            | 157212-019     | Fork Assembly   |
| PFG2-18442            | 157212-020     | Fork Assembly   |
| PFG2-18445            | 157212-021     | Fork Assembly   |
| PFG2-18448            | 157212-022     | Fork Assembly   |
| PFG2-18454            | 157212-023     | Fork Assembly   |
| PFG2-18460            | 157212-024     | Fork Assembly   |
| PFG2-18530            | 157212-033     | Fork Assembly   |
| PFG2-18536            | 157212-034     | Fork Assembly   |
| PFG2-18539            | 157212-035     | Fork Assembly   |
| PFG2-18542            | 157212-036     | Fork Assembly   |
| PFG2-18545            | 157212-037     | Fork Assembly   |
| PFG2-18548            | 157212-038     | Fork Assembly   |
| PFG2-18554            | 157212-039     | Fork Assembly   |
| PFG2-18560            | 157212-040     | Fork Assembly   |
| PFG3-18530            | 157212-049     | Fork Assembly   |
| PFG3-18536            | 157212-050     | Fork Assembly   |
| PFG3-18539            | 157212-051     | Fork Assembly   |
| PFG3-18542            | 157212-052     | Fork Assembly   |
| PFG3-18545            | 157212-053     | Fork Assembly   |
| PFG3-18548            | 157212-054     | Fork Assembly   |
| PFG3-18554            | 157212-055     | Fork Assembly   |
| PFG3-18560            | 157212-056     | Fork Assembly   |
| PGR2-15439            | 157212-003     | Fork Assembly   |
| PGR2-15442            | 157212-004     | Fork Assembly   |
| PGR2-15445            | 157212-005     | Fork Assembly   |
| PGR2-15448            | 157212-006     | Fork Assembly   |
| PGR2-15454            | 157212-007     | Fork Assembly   |
| PGR2-15460            | 157212-008     | Fork Assembly   |
| PGR2-18439            | 157212-011     | Fork Assembly   |
| PGR2-18442            | 157212-012     | Fork Assembly   |
| PGR2-18445            | 157212-013     | Fork Assembly   |
| PGR2-18448            | 157212-014     | Fork Assembly   |
| PGR2-18454            | 157212-015     | Fork Assembly   |
| PGR2-18460            | 157212-016     | Fork Assembly   |
| PRG2-15430            | 157212-001     | Fork Assembly   |
| PRG2-15436            | 157212-002     | Fork Assembly   |
| PRG2-18430            | 157212-009     | Fork Assembly   |
| PRG2-18436            | 157212-010     | Fork Assembly   |
| PRG2-18530            | 157212-025     | Fork Assembly   |
| PRG2-18536            | 157212-026     | Fork Assembly   |
| PRG2-18539            | 157212-027     | Fork Assembly   |
| PRG2-18542            | 157212-028     | Fork Assembly   |
| PRG2-18545            | 157212-029     | Fork Assembly   |
| PRG2-18548            | 157212-030     | Fork Assembly   |
| PRG2-18554            | 157212-031     | Fork Assembly   |
| PRG2-18560            | 157212-032     | Fork Assembly   |
| PRG3-18530            | 157212-041     | Fork Assembly   |
| PRG3-18536            | 157212-042     | Fork Assembly   |
| PRG3-18539            | 157212-043     | Fork Assembly   |
| PRG3-18542            | 157212-044     | Fork Assembly   |
| PRG3-18545            | 157212-045     | Fork Assembly   |
| PRG3-18548            | 157212-046     | Fork Assembly   |
| PRG3-18554            | 157212-047     | Fork Assembly   |
| PRG3-18560            | 157212-048     | Fork Assembly   |

## Section 8

# Battery and Charger

### Contents

|   |      |
|---|------|
| V-Force® Industrial Battery Chargers  | 8.02 |
| Charger Stands  | 8.04 |
| Charger Accessories   | 8.05 |
| Battery Chargers  | 8.06 |
| Charger Cords   | 8.08 |
| Battery Cable Assemblies  | 8.09 |
| Battery Room Checklist  | 8.11 |
| V-Force® Industrial Lithium-Ion Batteries   | 8.13 |
|  V-Force® Industrial Lead-Acid Batteries | 8.15 |
| V-Force® Deep Cycle Batteries   | 8.16 |
| V-Force® Starter Batteries  | 8.17 |
| V-Force® Battery Display Rack   | 8.17 |
| V-Force® Retail Mobility Cart Batteries   | 8.18 |
| Battery Cross Reference   | 8.18 |
| Rescue Jump Packs   | 8.20 |
| Battery Watering Application Chart & Systems  | 8.21 |
| Watering Gun  | 8.23 |
| Float System Parts  | 8.24 |
| Battery Watering Injector System  | 8.26 |
| Battery Accessories   | 8.29 |
| Battery Repair Parts  | 8.30 |
| Leadhead Shrouds & Intercell Connectors   | 8.30 |
| Safety Boots/Protective Caps  | 8.33 |
| Battery Connectors  | 8.33 |
| Power Cable & Accessories   | 8.38 |
| Battery Acid Indicators   | 8.39 |
| Battery Tools   | 8.39 |
| Battery Service Supplies  | 8.43 |

### New Items:

V-HFM3 FS4/6 Mounting Bracket - p. 8.05  
V-HFM3 Accessory Cable - p. 8.05  
Power Cable NEMA/CEE7 14AWG 2M BLK - p. 8.13  
V-Force Industrial Lead-Acid Batteries - p. 8.15  
Couple/Adapter Female Euro320 - p. 8.37  
Hex Crimper 24" - p. 8.40  
Torque Wrench with 3/8" Drive Ratchet - p. 8.40  
10mm x 1.5 Bottom Tap - p. 8.40  
Insulated Socket Set/Standard - p. 8.41  
Insulated Socket Set/Metric - p. 8.41  
Non Conductive Screwdriver Set - p. 8.41  
Non Conductive Pliers - p. 8.41  
Torque Wrench 10 Nm - 60Nm - p. 8.41  
Battery Tool Bag - p. 8.41  
Hex Crimper 24" - p. 8.42

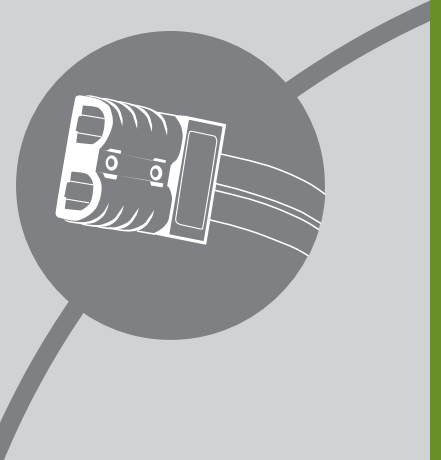

Note: 1910.178(g)(5) (1998) of the Occupational Safety and Health Act (OSHA) requires that "All parts of any such industrial truck requiring replacement shall be replaced only by parts equivalent as to safety with those used in the original design."



# V-HFM<sup>3</sup> Series



HFM<sup>3</sup> FS3

### Features

- Modular design
- Reliable and redundant
- Multi voltage and multi amp hr
- Capable of Conventional, Opportunity, Fast or V-Force Lithium-ion profiles
- Lithium ready option
- Auto equalization by cycles or date/time

- Optional current sensing BMID available
- Downloadable event log - up to 10,000
- Marks of Conformity - UL Listed, cUL Listed, CEC-BC Compliant
- Mounting bracket included
- Warranty - 2 years full plus 1 year parts
- V-HFM<sup>3</sup> FS6 - dual cable

**Note:** P.N. 300118-001 for USB cable

*Note: For additional information, please reference the brochure and price pages available through your local Crown dealer or the Partner Site.*



HFM<sup>3</sup> FS4

| Model Number | Cabinet Size | No. of Modules | Max Current | DC Voltage | Amp Hour Range Conventional | Amp Hour Range Opportunity | Amp Hour Range Fast | Amps Output Lithium-Ion | Phase | AC Input | Max Weight (lbs.) |
|--------------|--------------|----------------|-------------|------------|-----------------------------|----------------------------|---------------------|-------------------------|-------|----------|-------------------|
| FS3-MP342-1  | FS3          | 1              | 100         | 24, 36     | 300 - 625                   | 300 - 400                  |                     | 100                     | 3     | 208, 240 | 27                |
|              | FS3          | 1              | 85          | 48         | 300 - 525                   | 300 - 325                  |                     | 85                      | 3     | 208, 240 | 27                |
| FS3-MP342-2  | FS3          | 2              | 200         | 24, 36     | 300 - 1250                  | 300 - 800                  |                     | 200                     | 3     | 208, 240 | 32.2              |
|              | FS3          | 2              | 170         | 48         | 300 - 1050                  | 300 - 675                  |                     | 170                     | 3     | 208, 240 | 32.2              |
|              | FS3          | 2              | 100         | 72, 80     | 300 - 625                   | 300 - 400                  |                     | 100                     | 3     | 208, 240 | 32.2              |
|              | FS3          | 2              | 84          | 96         | 300 - 500                   |                            |                     | 84                      | 3     | 208, 240 | 32.2              |
| FS3-MP342-3  | FS3          | 3              | 300         | 24, 36     | 300 - 1875                  | 300 - 1200                 |                     | 300                     | 3     | 208, 240 | 37.4              |
|              | FS3          | 3              | 255         | 48         | 300 - 1575                  | 300 - 1000                 |                     | 255                     | 3     | 208, 240 | 37.4              |
|              | FS3          | 3              | 150         | 72, 80     | 300 - 925                   | 300 - 600                  |                     | 150                     | 3     | 208, 240 | 37.4              |
|              | FS3          | 3              | 126         | 96         | 300 - 750                   | 300 - 500                  |                     | 126                     | 3     | 208, 240 | 37.4              |
| FS3-MP344-1  | FS3          | 1              | 100         | 24, 36     | 300 - 625                   | 300 - 400                  |                     | 100                     | 3     | 480      | 27                |
|              | FS3          | 1              | 85          | 48         | 300 - 525                   | 300 - 325                  |                     | 85                      | 3     | 480      | 27                |
|              | FS3          | 1              | 50          | 72, 80     |                             |                            |                     | 50                      | 3     | 480      | 27                |
|              | FS3          | 1              | 42          | 96         |                             |                            |                     | 42                      | 3     | 480      | 27                |
| FS3-MP344-2  | FS3          | 2              | 200         | 24, 36     | 300 - 1250                  | 300 - 800                  | 300 - 500           | 200                     | 3     | 480      | 32.2              |
|              | FS3          | 2              | 170         | 48         | 300 - 1050                  | 300 - 675                  | 300 - 425           | 170                     | 3     | 480      | 32.2              |
|              | FS3          | 2              | 100         | 72, 80     | 300 - 625                   | 300 - 400                  |                     | 100                     | 3     | 480      | 32.2              |
|              | FS3          | 2              | 84          | 96         | 300 - 500                   |                            |                     | 84                      | 3     | 480      | 32.2              |
| FS3-MP344-3  | FS3          | 3              | 300         | 24, 36     | 300 - 1875                  | 300 - 1200                 | 300 - 750           | 300                     | 3     | 480      | 37.4              |
|              | FS3          | 3              | 255         | 48         | 300 - 1575                  | 300 - 1000                 | 300 - 625           | 255                     | 3     | 480      | 37.4              |
|              | FS3          | 3              | 150         | 72, 80     | 300 - 925                   | 300 - 600                  |                     | 150                     | 3     | 480      | 37.4              |
|              | FS3          | 3              | 126         | 96         | 300 - 750                   | 300 - 500                  |                     | 126                     | 3     | 480      | 37.4              |
| FS4-MP344-4  | FS4          | 4              | 400         | 24, 36     |                             | 300 - 1600                 |                     | 400                     | 3     | 480      | 61.1              |
|              | FS4          | 4              | 340         | 48         | 300 - 1875                  | 300 - 1350                 |                     | 340                     | 3     | 480      | 61.1              |
|              | FS4          | 4              | 200         | 72, 80     | 300 - 1250                  | 300 - 800                  |                     | 200                     | 3     | 480      | 61.1              |
|              | FS4          | 4              | 168         | 96         | 300 - 1050                  | 300 - 350                  |                     | 168                     | 3     | 480      | 61.1              |
| FS4-MP344-5  | FS4          | 5              | 400         | 48         |                             |                            |                     | 400                     | 3     | 480      | 66.3              |
|              | FS4          | 5              | 250         | 72, 80     | 300 - 1550                  | 300 - 1000                 |                     | 250                     | 3     | 480      | 66.3              |
|              | FS4          | 5              | 210         | 96         | 300 - 1300                  | 300 - 825                  |                     | 210                     | 3     | 480      | 66.3              |
| FS4-MP344-6  | FS4          | 6              | 300         | 72, 80     | 300 - 1875                  | 300 - 1200                 |                     | 300                     | 3     | 480      | 71.5              |
|              | FS4          | 6              | 252         | 96         | 300 - 1575                  | 300 - 1000                 |                     | 252                     | 3     | 480      | 71.5              |
| FS6-MP344-4  | FS6          | 4              | 400         | 24, 36     |                             |                            | 300 - 1000          |                         | 3     | 480      | 61.1              |
|              | FS6          | 4              | 340         | 48         |                             |                            | 300 - 850           |                         | 3     | 480      | 61.1              |
|              | FS6          | 4              | 200         | 72, 80     |                             |                            | 300 - 500           |                         | 3     | 480      | 61.1              |
|              | FS6          | 4              | 168         | 96         |                             |                            | 300 - 400           |                         | 3     | 480      | 61.1              |
| FS6-MP344-5  | FS6          | 5              | 500         | 24, 36     |                             |                            | 300 - 1250          |                         | 3     | 480      | 66.3              |
|              | FS6          | 5              | 425         | 48         |                             |                            | 300 - 1050          |                         | 3     | 480      | 66.3              |
|              | FS6          | 5              | 250         | 72, 80     |                             |                            | 300 - 625           |                         | 3     | 480      | 66.3              |
|              | FS6          | 5              | 210         | 96         |                             |                            | 300 - 525           |                         | 3     | 480      | 66.3              |
| FS6-MP344-6  | FS6          | 6              | 600         | 24, 36     |                             |                            | 300 - 1500          |                         | 3     | 480      | 71.5              |
|              | FS6          | 6              | 510         | 48         |                             |                            | 300 - 1275          |                         | 3     | 480      | 71.5              |
|              | FS6          | 6              | 300         | 72, 80     |                             |                            | 300 - 750           |                         | 3     | 480      | 71.5              |
|              | FS6          | 6              | 252         | 96         |                             |                            | 300 - 625           |                         | 3     | 480      | 71.5              |
| FS3-MP346-1  | FS3          | 1              | 100         | 24, 36     | 300 - 625                   | 300 - 400                  |                     | 100                     | 3     | 600      | 27                |
|              | FS3          | 1              | 85          | 48         | 300 - 525                   | 300 - 325                  |                     | 85                      | 3     | 600      | 27                |
|              | FS3          | 1              | 50          | 72, 80     |                             |                            |                     | 50                      | 3     | 600      | 27                |
|              | FS3          | 1              | 42          | 96         |                             |                            |                     | 42                      | 3     | 600      | 27                |
| FS3-MP346-2  | FS3          | 2              | 200         | 24, 36     | 300 - 1250                  | 300 - 800                  | 300 - 500           | 200                     | 3     | 600      | 32.2              |
|              | FS3          | 2              | 170         | 48         | 300 - 1050                  | 300 - 675                  | 300 - 425           | 170                     | 3     | 600      | 32.2              |
|              | FS3          | 2              | 100         | 72, 80     | 300 - 625                   | 300 - 400                  |                     | 100                     | 3     | 600      | 32.2              |
|              | FS3          | 2              | 84          | 96         | 300 - 500                   |                            |                     | 84                      | 3     | 600      | 32.2              |
| FS3-MP346-3  | FS3          | 3              | 300         | 24, 36     | 300 - 1875                  | 300 - 1200                 | 300 - 750           | 300                     | 3     | 600      | 37.4              |
|              | FS3          | 3              | 255         | 48         | 300 - 1575                  | 300 - 1000                 | 300 - 625           | 255                     | 3     | 600      | 37.4              |
|              | FS3          | 3              | 150         | 72, 80     | 300 - 925                   | 300 - 600                  |                     | 150                     | 3     | 600      | 37.4              |
|              | FS3          | 3              | 126         | 96         | 300 - 750                   | 300 - 500                  |                     | 126                     | 3     | 600      | 37.4              |
| FS4-MP346-4  | FS4          | 4              | 400         | 24, 36     |                             | 300 - 1600                 |                     | 400                     | 3     | 600      | 61.1              |
|              | FS4          | 4              | 340         | 48         | 300 - 1875                  | 300 - 1350                 |                     | 340                     | 3     | 600      | 61.1              |

⚠WARNING: Cancer and reproductive harm - [www.P65Warnings.ca.gov](http://www.P65Warnings.ca.gov)

# Industrial Battery Chargers

| Model Number | Cabinet Size | No. of Modules | Max Current | DC Voltage | Amp Hour Range Conventional | Amp Hour Range Opportunity | Amp Hour Range Fast | Amps Output Lithium-Ion | Phase | AC Input | Max Weight (lbs.) |
|--------------|--------------|----------------|-------------|------------|-----------------------------|----------------------------|---------------------|-------------------------|-------|----------|-------------------|
| FS4-MP346-4  | FS4          | 4              | 200         | 72, 80     | 300 - 1250                  | 300 - 800                  |                     | 200                     | 3     | 600      | 61.1              |
|              | FS4          | 4              | 168         | 96         | 300 - 1050                  | 300 - 650                  | 300-650             | 168                     | 3     | 600      | 61.1              |
| FS4-MP346-5  | FS4          | 5              | 400         | 48         |                             |                            |                     | 400                     | 3     | 600      | 66.3              |
|              | FS4          | 5              | 250         | 72, 80     | 300 - 1550                  | 300 - 1000                 |                     | 250                     | 3     | 600      | 66.3              |
| FS4-MP346-6  | FS4          | 5              | 210         | 96         | 300 - 1300                  | 300 - 825                  |                     | 210                     | 3     | 600      | 66.3              |
|              | FS4          | 6              | 300         | 72, 80     | 300 - 1875                  | 300 - 1200                 |                     | 300                     | 3     | 600      | 71.5              |
| FS6-MP346-4  | FS6          | 6              | 252         | 96         | 300 - 1575                  | 300 - 1000                 |                     | 252                     | 3     | 600      | 71.5              |
|              | FS6          | 4              | 400         | 24, 36     |                             |                            | 300 - 1000          |                         | 3     | 600      | 61.1              |
| FS6-MP346-5  | FS6          | 4              | 340         | 48         |                             |                            | 300 - 850           |                         | 3     | 600      | 61.1              |
|              | FS6          | 4              | 200         | 72, 80     |                             |                            | 300 - 500           |                         | 3     | 600      | 61.1              |
|              | FS6          | 4              | 168         | 96         |                             |                            | 300 - 400           |                         | 3     | 600      | 61.1              |
|              | FS6          | 5              | 500         | 24, 36     |                             |                            | 300 - 1250          |                         | 3     | 600      | 66.3              |
| FS6-MP346-6  | FS6          | 5              | 425         | 48         |                             |                            | 300 - 1050          |                         | 3     | 600      | 66.3              |
|              | FS6          | 5              | 250         | 72, 80     |                             |                            | 300 - 625           |                         | 3     | 600      | 66.3              |
|              | FS6          | 5              | 210         | 96         |                             |                            | 300 - 525           |                         | 3     | 600      | 66.3              |
|              | FS6          | 6              | 600         | 24, 36     |                             |                            | 300 - 1500          |                         | 3     | 600      | 71.5              |
| FS6-MP346-6  | FS6          | 6              | 510         | 48         |                             |                            | 300 - 1275          |                         | 3     | 600      | 71.5              |
|              | FS6          | 6              | 300         | 72, 80     |                             |                            | 300 - 750           |                         | 3     | 600      | 71.5              |
|              | FS6          | 6              | 252         | 96         |                             |                            | 300 - 625           |                         | 3     | 600      | 71.5              |

⚠️WARNING: Cancer and reproductive harm - [www.P65Warnings.ca.gov](http://www.P65Warnings.ca.gov)

Note: For additional information, please reference the brochure and price pages available through your local Crown dealer or the Partner Site.

## V-HFE Series

### High-Frequency Economy Chargers

#### Features

- High efficiency = energy savings
- Simple and flexible to configure via the display
- Compact and lightweight
- High reliability
- Reliable and redundant
- Maximize battery life with the IEL profile
- CE and RoHS Compliant – UL listed
- Mounting bracket included with every FS3 model charger
- Warranty - 1 year full plus 4 years parts



Note: A/C power cord option now available; see pages 8.09 for details.

| Model Number | Cabinet Size | No. of Modules | Max Current | DC Voltage | Amp Hour Range Conventional | Module Color | Single/ Triple Phase | AC Input | Max Weight (lbs.) |
|--------------|--------------|----------------|-------------|------------|-----------------------------|--------------|----------------------|----------|-------------------|
| FS3-MP124-2  | FS3          | 2              | 120         | 24         | 300-750                     |              | 1,3                  | 208, 240 | 40 lbs.           |
| FS3-MP324-2  | FS3          | 2              | 120         | 24         | 300-750                     |              | 3                    | 480      | 40 lbs.           |
| FS3-MP124-3  | FS3          | 3              | 180         | 24         | 750-1050                    |              | 1,3                  | 208, 240 | 46 lbs.           |
| FS3-MP324-3  | FS3          | 3              | 180         | 24         | 750-1050                    |              | 3                    | 480      | 46 lbs.           |
| FS3-MP136-2  | FS3          | 2              | 120         | 36         | 300-750                     |              | 1,3                  | 208, 240 | 40 lbs.           |
| FS3-MP336-2  | FS3          | 2              | 120         | 36         | 300-750                     |              | 3                    | 480      | 40 lbs.           |
| FS3-MP336-3  | FS3          | 3              | 180         | 36         | 300-1200                    |              | 3                    | 480      | 46 lbs.           |
| FS3-MP348-2  | FS3          | 2              | 100         | 48         | 300-625                     |              | 3                    | 480      | 40 lbs.           |
| FS3-MP348-3  | FS3          | 3              | 150         | 48         | 300-1050                    |              | 3                    | 480      | 46 lbs.           |

Cabinet Size: 7.75" W x 15.15" D x 15.25" H

Note: For additional information, please reference the brochure and price pages available through your local Crown dealer or the Partner Site.

⚠️WARNING: Cancer and reproductive harm - [www.P65Warnings.ca.gov](http://www.P65Warnings.ca.gov)

## V-HFM Series

### High-Frequency Modular Chargers

#### Features

- Modular design
- Reliable and redundant
- Multi voltage and multi amp hr
- Capable of Conventional profiles
- Auto equalization by cycles or date/time
- Downloadable event log – up to 2400 events
- CE and RoHS Compliant – UL listed
- Mounting bracket included
- Warranty - 1 year full plus 4 years parts
- A/C power cord option available; see page 8.09
- P.N. 300118 for USB cable



FS3



| Model Number | Cabinet Size | Number of Modules | Max Current | DC Voltage | Amp Hour Range Conventional | Module Color | Single/ Triple Phase | AC Input | Max Weight (lbs.) |
|--------------|--------------|-------------------|-------------|------------|-----------------------------|--------------|----------------------|----------|-------------------|
| FS3-MP130-2  | FS3          | 2                 | 120         | 24,36      | 300-750                     |              | 1                    | 208, 240 | 40                |
| FS3-MP130-3  | FS3          | 3                 | 180         | 24,36      | 300-1200                    |              | 1                    | 208, 240 | 46                |

Cabinet Size FS3: 7.75" W x 15.15" D x 15.25" H

Note: For additional information, please reference the brochure and price pages available through your local Crown dealer or the Partner Site.

⚠️WARNING: Cancer and reproductive harm - [www.P65Warnings.ca.gov](http://www.P65Warnings.ca.gov)

# Charger Stand

For use with V-HFM<sup>3</sup>, V-HFE and V-HFM

## Features and Benefits

- Sleek versatile design offers multiple configuration options.
- Heavy duty steel frame construction.
- Stand securely anchors to the floor and holds chargers safely in place.
- Designed to free up valuable warehouse floor space.
- Uses mounting bracket included with charger.
- Heavy Duty Pogo Stick and Tender Kit are recommended for V-HFM<sup>3</sup> Part Number 300038-1ZD-01



Part Number - 396600-014-01

### Rail Stop

The rail stop can be installed in front of existing charging stations or with the V-Force charger stand. The required anchor bolts to attach the stop to the warehouse floor are included. Dimensions: 10" H x 34" L. Weight: 34 lbs.



| Standard 55" Post |                        |           |                             |                      |                       |          |
|-------------------|------------------------|-----------|-----------------------------|----------------------|-----------------------|----------|
| Item Number       | Single or Double Mount | Side View | Series                      | Cabinet              | Maximum # Of Chargers | Top View |
| CS2-18-SS         | Single Side            |           | HFM/HFE<br>HFM <sup>3</sup> | FS3<br>FS3, FS4, FS6 | UP TO 2<br>1          |          |
| CS2-18-DS         | Double Sided           |           | HFM/HFE<br>HFM <sup>3</sup> | FS3<br>FS3, FS4, FS6 | UP TO 4<br>UP TO 2    |          |
| CS2-25-SS         | Single Side            |           | HFM/HFE<br>HFM <sup>3</sup> | FS3<br>FS3, FS4, FS6 | UP TO 3<br>UP TO 2    |          |
| CS2-25-DS         | Double Sided           |           | HFM/HFE<br>HFM <sup>3</sup> | FS3<br>FS3 ONLY      | UP TO 6<br>UP TO 4    |          |
| CS2-37-SS         | Single Side            |           | HFM/HFE<br>HFM <sup>3</sup> | FS3<br>FS3 ONLY      | UP TO 4<br>UP TO 3    |          |
| CS2-37-DS         | Double Sided           |           | HFM <sup>3</sup>            | FS3 ONLY             | UP TO 6               |          |
| CS2-50-SS         | Single Side            |           | HFM <sup>3</sup>            | FS3 ONLY             | UP TO 4               |          |

### Pogo Sticks

**NOTE: Heavy duty pogo Sticks are not included with the charger stands. 1 pogo stick per charger will need to be ordered.**

| Tall 84" Post |                        |           |                             |                      |                       |          |
|---------------|------------------------|-----------|-----------------------------|----------------------|-----------------------|----------|
| Item Number   | Single or Double Mount | Side View | Series                      | Cabinet              | Maximum # Of Chargers | Top View |
| CS2T-18-SS    | Single Side            |           | HFM/HFE<br>HFM <sup>3</sup> | FS3<br>FS3, FS4, FS6 | UP TO 2<br>1          |          |
| CS2T-18-DS    | Double Sided           |           | HFM/HFE<br>HFM <sup>3</sup> | FS3<br>FS3, FS4, FS6 | UP TO 4<br>UP TO 2    |          |
| CS2T-25-SS    | Single Side            |           | HFM/HFE<br>HFM <sup>3</sup> | FS3<br>FS3, FS4, FS6 | UP TO 4<br>UP TO 2    |          |
| CS2T-25-DS    | Double Sided           |           | HFM <sup>3</sup>            | FS3 ONLY             | UP TO 4               |          |

### Cable Retractors

**NOTE: Cable retractors are not included with the charger stands. 1 cable retractor per charger will need to be ordered.**

**Battery Monitoring Identification Device (BMID)**

Part Number - 396525-BTM

- Automatically programs V-Force V-HFM/V-HFM<sup>3</sup> chargers with the correct battery charge profile.
- Dual profile configuration to optimize battery health and SOC for opportunity or fast charging.
- Records all battery events including temperature, charge and discharge cycles.
- Current sensing up to +/- 1300 amps.
- Electrolyte level sensor.
- Temperature probe senses battery temperature throughout the complete charge cycle and adjusts the charge profile as needed.



- Larger toroid to fit 4/0 cable.
- Rugged case construction resists impact, water, and battery electrolyte spills.
- Bluetooth® Class 1 for improved range when connecting to a laptop or tablet.
- UL Classified
- Installation kit included (P.N. 396525-KIT)

**Replacement parts:**

Temperature Sensor - P.N. 396573;  
Installation Kit - P.N. 396525-KIT

**Mounting Hardware**

The **Mounting Bracket** is a convenient solution for mounting charger cabinets.



396583

**V-HFM<sup>3</sup> Mounting Bracket**

Part Number - 396583

- Heavy duty steel construction supports up to 50 lbs.
- Allows the FS3 charger cabinet to be mounted from the rear, side or to stand.
- Included with every HFM<sup>3</sup> model charger.
- Frees up floor space and keeps charger secure to prevent damage.



396583-001

Part Number - 396583-001

- Included with every HFM<sup>3</sup> FS4/FS6 charger



**V-HFM and V-HFE Mounting Bracket**

Part Number - 396521-001

- Included with every HFM and HFE FS3 Cabinet



396521-001

⚠WARNING: Cancer and reproductive harm - [www.P65Warnings.ca.gov](http://www.P65Warnings.ca.gov)

**Long L-Bracket** is used in conjunction with a pogo stick to keep cables elevated and off the floor.

Part Number - 396547-002



- Use the longer L-bracket to mount to the wall next to the FS3 size cabinet charger.
- Can be used with both our standard and heavy duty pogo sticks.

Also available:

**L-Bracket and Pogo Stick**

P.N. 396547-BKT

**L-Bracket with Heavy Duty Pogo Tender Kit**

P.N. 396547-BKT-01

\*Recommended for use with V-HFM<sup>3</sup> FS3-3 models and larger.

⚠WARNING: Cancer and reproductive harm - [www.P65Warnings.ca.gov](http://www.P65Warnings.ca.gov)

**Tool Balance Swivel Mount**



| Part No.   | Min.-Max. Load | Reel Weight | Cable Length |
|------------|----------------|-------------|--------------|
| 300038-005 | 3.0-5.0 lbs.   | 1.5 lbs.    | 6'           |

The BD Series Tool Balancer is an economical choice for balancing tools weighing up to 5 lbs. The molded ABS housing has a smooth exterior with rounded edges designed for maximum ergonomic appeal. The tool balancer is easy to adjust and reliable.

**Tower Light**

Part Number - 396586-001



- HFM<sup>3</sup> LED light indicates battery charge status from a distance.
- Includes 11.81 inch pole with mounting bracket, I/O expansion board with internal wiring loom, expansion board mounting standoff and DE9 mounting standoffs.

⚠WARNING: Cancer and reproductive harm - [www.P65Warnings.ca.gov](http://www.P65Warnings.ca.gov)

**Remote Switch**

| Part No.   | Description   |
|------------|---|
| 396587-001 | Use with V-HFM <sup>3</sup> chargers that are mounted in a location not easy to access. |
| 396555     | Use with V-HFM chargers that are mounted in a location not easy to access.              |

Note: includes I/O Board, wiring harness and mounting hardware.



396587-001



396555

**Replacement parts for Part No. 396587-001:**  
Remote control only - P.N. 396587  
Remote control cable - P.N. 396587-002

⚠WARNING: Cancer and reproductive harm - [www.P65Warnings.ca.gov](http://www.P65Warnings.ca.gov)

**V-HFM and V-HFM<sup>3</sup> USB Cables**

| Part No.   | Description  |
|------------|--|
| 300118     | USB A to Mini-B 2.0 cable for programming V-HFM Series High Frequency Chargers with Laptop.                    |
| 300118-001 | USB A to Micro-B 2.0 cable used for laptops and Galaxy Tables S3, S4 and S5.                                   |
| 300118-002 | Micro USB to USB A adaptor to program V-HFM <sup>3</sup> with tablet. <b>This is required for all tablets.</b> |
| 300118-003 | USB Type C to USB A cable used for S6 and newer tablets.   |
| 396592     | v-HFM3 Accessory Cable, 3M   |



300118



396592



## Charger Accessories

### Battery Pogo Stick

| Part No. | Description  |
|----------|--|
| 300038   | Used to keep battery connectors and cables off the floor at charging stations, preventing damage and wear. 39" in length, 1" in diameter. Supports up to 10 ft of 3/0 cable. |



▲ **Replacement Rubber Grommet**  
P.N. 300038-001



▲ **WARNING:** Cancer and reproductive harm - [www.P65Warnings.ca.gov](http://www.P65Warnings.ca.gov)

### Heavy Duty Battery Pogo Stick

| Part No.   | Description  |
|------------|--|
| 300038-1ZD | Zinc plated 40". Up to 66% stronger than competitive designs. Mounting hardware included. Includes rubber grommet clamp. |



Also available: Heavy Duty Tender Kit  
P.N. 300038-1ZD-01  
Includes Heavy Duty Pogo Stick and Tender Kit.  
\*Recommended for for V-HFM<sup>3</sup> applications.

▲ **WARNING:** Cancer and reproductive harm - [www.P65Warnings.ca.gov](http://www.P65Warnings.ca.gov)

### Tender Kit

| Part No. | Description  |
|----------|--|
| 309820   | Secure large DC battery cables with or without a pogo stick. Superior strength and high performance in the most extreme applications. Heavy-duty clamp design corrosion resistant composite body. 16" Single with Clamp. |



▲ **WARNING:** Cancer and reproductive harm - [www.P65Warnings.ca.gov](http://www.P65Warnings.ca.gov)

### V-Force Cable Retractor

| Part No.   | Description                                |
|------------|--|
| 396625     | Cable Retractor                            |
| 396625-001 | Cable Retractor with Grommet/Cable Housing |



Balance DC charger cables or tools weighing up to 15 lbs. Spring tension adjusts easily.

396625-001

### Cable Retractor

| Part No.   | Description   |
|------------|---|
| 300038-002 | Heavy-duty cable retractor holds larger cables and is adjustable and lightweight. The retractor mounts to charger stand, shelf or wall bracket by 2 mounting holes. |



▲ **WARNING:** Cancer and reproductive harm - [www.P65Warnings.ca.gov](http://www.P65Warnings.ca.gov)

### Magnet Mount Cable Holder

| Part No. | Description   |
|----------|---|
| 396568   | Conveniently secures battery and charger cables, preventing cable damage and clutter. Mount to any flat, ferrous metallic surface such as a charger stand, charger wall bracket, or charger case. |



▲ **WARNING:** Cancer and reproductive harm - [www.P65Warnings.ca.gov](http://www.P65Warnings.ca.gov)

## Battery Chargers

Continued ▶



### V-110 Portable Charger

Part Number - 390040-125-02



390040-BRKT

#### Features

- Auto start/stop
- 11.26" L x 7" W x 8.27" H
- 24V; 40 amps output
- Weight: 20 lbs.
- SB175 red connector attached; gray connector included
- 1-year warranty
- UL and CSA compliant
- HF Charging technology
- Single Phase AC self adjusts for 100V to 240V; 220V Euro Power Cord Required - P.N. 390040-001
- Wall mount bracket available - P.N. 390040-BRKT

▲ **WARNING:** Cancer and reproductive harm - [www.P65Warnings.ca.gov](http://www.P65Warnings.ca.gov)

### On-Board Charger

Part Number - 370337



#### Features

- 9.1" L x 5" W x 2.98" H
- 24V; 20 amps output
- Weight: 5 lbs.
- 120Vac - 50/60Hz
- SB175 red connector
- 3-year warranty
- UL, CSA, CE and CEC compliant
- HF Charging technology

Replacement DC Output Cable: P.N. 370337-001

|                       |                 |       |             |
|-----------------------|-----------------|-------|-------------|
|                       | ▼ OEM Reference |       |             |
| Applied Energy (Colt) | A15124          | RA    | 939-353-286 |
| BT                    | 313799-001      | Zivan | NG1         |
| PM                    | 313799-001      | Zivan | UG1-24-30A  |
| RA                    | 313799-001      |       |             |

▲ **WARNING:** Cancer - [www.P65Warnings.ca.gov](http://www.P65Warnings.ca.gov)



**Portable or On-Board - 12, 24 or 36 Volt Charger**

**Features**

- Use with Lead Acid (Wet/AGM) batteries
- Designed for tough duty applications
- UL approved
- Exclusive temperature compensation
- Reverse polarity spark free operation
- Fan cooled
- Portable and On Board Options
- Fully automatic with float maintenance
- Made in USA



| Part Number  | Output Voltage | Output Amps | Input Voltage | Cycle    | Dimensions H x W x L (in) | Connector Attached                    | Weight   | Brand                    | Description |
|--------------|----------------|-------------|---------------|----------|---------------------------|---------------------------------------|----------|--------------------------|-------------|
| 391210       | 12             | 10          | 120V          | 50-60 hz | 4.75 x 8.00 x 6.38        | SB50                                  | 5.5 lbs. | Sportsman Series         | Portable    |
| 391215       | 12             | 15          | 120V          | 50-60 hz | 5.00 x 8.25 x 6.38        | Ring Terminals                        | 7 lbs.   | Professional Series      | Portable    |
| 391225       | 12             | 25          | 120V          | 50-60 hz | 8.25 x 8.38 x 9.75        | SB50                                  | 19 lbs.  | Eagle Performance Series | Portable    |
| 392412       | 24             | 12          | 120V          | 50-60 hz | 9.75 x 8.38 x 8.25        | SB50                                  | 19 lbs.  | Eagle Performance Series | Portable    |
| 392425       | 24             | 25          | 120V          | 50-60 hz | 9.75 x 8.38 x 8.25        | SB50                                  | 19 lbs.  | Eagle Performance Series | Portable    |
| 393625       | 36             | 25          | 120V          | 50-60 hz | 9.75 x 8.38 x 8.25        | SB50                                  | 19 lbs.  | Eagle Performance Series | Portable    |
| 394815       | 48             | 15          | 120V          | 50-60 hz | 8.25 x 8.38 x 9.75        | SB50                                  | 19 lbs.  | Eagle Performance Series | Portable    |
| 391225-OB    | 12             | 25          | 120V          | 50-60 hz | 5.75 x 8.50 x 9.00        | Ring Terminals                        | 19 lbs.  | Eagle Performance Series | On-Board    |
| 392425-OB    | 24             | 25          | 120V          | 50-60 hz | 9.00 x 8.50 x 5.75        | Ring Terminals                        | 22 lbs.  | Eagle Performance Series | On-Board    |
| 393625-OB    | 36             | 25          | 120V          | 50-60 hz | 9.00 x 8.50 x 5.75        | Ring Terminals                        | 28 lbs.  | Eagle Performance Series | On-Board    |
| 392425-OBTD* | 24             | 25          | 120V          | 50-60 hz | 5.75 x 8.50 x 12.5        | Ring Terminals/<br>18 AWG/14AWG/12AWG | 22 lbs.  | Eagle Performance Series | On-Board    |
| 393625-OBTD* | 36             | 25          | 120V          | 50-60 hz | 5.75 x 8.50 x 12.5        | Ring Terminals/<br>18 AWG/14AWG/12AWG | 28 lbs.  | Eagle Performance Series | On-Board    |
| 394818-OBTD* | 48             | 18          | 120V          | 50-60 hz | 5.75 x 8.50 x 12.5        | Ring Terminals/<br>18 AWG/14AWG/12AWG | 28 lbs.  | Eagle Performance Series | On-Board    |

\*Replacement Charger for Taylor Dunn Carts



Part Number - 370359

**Charger On-Board**

- 8.5" L x 4.8" W x 2.92" H
- 24V
- 12 amps
- Weight 5 lbs.
- Includes inhibit cable that enables truck

▼ OEM Reference

HY 4023332 YT 582010485

⚠ **WARNING:** Cancer - [www.P65Warnings.ca.gov](http://www.P65Warnings.ca.gov)



Part Number - 370349

**Delta Q On-Board Charger**

- 9.92" L x 7.32" W x 3.15" H
- 24 Vdc
- Input voltage 85-270Vac
- Weight 6.5 lbs.

Note: AC Power Cord sold separately, P.N. 396351

▼ OEM Reference  
Delta Q IC650

| Part No. | Input Voltage |
|----------|---------------|
| 165634   | IC650-24-COMM |
| 163280   | IC600         |

⚠ **WARNING:** Cancer and reproductive harm - [www.P65Warnings.ca.gov](http://www.P65Warnings.ca.gov)



Part Number - 370253

**Battery Charger**

- 20" L x 5" W x 3.25 H"
- 24V
- 15 amps
- Weight 23 lbs.

▼ OEM Reference

RA 850-138-139-02 TY 00590-43337-71



Part Number - 370600

**12V 100W Power Inverter**

- Supply 115 V AC or 5V DC via USB from service van cigarette lighter
- Provide AC power to products that require 100W or less
- Swivel mounting allows for left or right adjustment
- High speed cooling fan protects from overheating

⚠ **WARNING:** Cancer and reproductive harm - [www.P65Warnings.ca.gov](http://www.P65Warnings.ca.gov)



Part Number - 370252

**Charger On-Board**

- 11" L x 4.5" W x 7" H
- 24V
- Output amps 18
- Input voltage 120V
- Weight 20 lbs.
- Charges gel battery

▼ OEM Reference

|            |              |              |
|------------|--------------|--------------|
| HY 1607815 | HY 4603626   | YT 580055473 |
| HY 2048079 | HY 8512512   | YT 580087314 |
| HY 2054228 | YT 524245865 | YT 582003887 |
| HY 2073416 | YT 580029671 |              |
| HY 2102631 | YT 580034920 |              |

## Charger Cords



Part Number - GN100195GT  
**Replacement Power Cord AC**  
 ■ 6 ft. 7 in. long  
 ■ 300v  
 ■ 15 amp, 13 amp plug  
 ▼ OEM Reference  
 DEKA IMP-9412

⚠ **WARNING:** Cancer and reproductive harm - [www.P65Warnings.ca.gov](http://www.P65Warnings.ca.gov)



Part Number - 396350  
**Replacement Power Cord**  
 ■ 12" of straight cord on either side of 12" constricted spiral cord (60" total length)  
 ■ For Zivan charger  
 ▼ OEM Reference  
 GNB V04SPRLCORD



Part Number - 126711  
**Replacement Charger Cord AC**  
 ■ 8.2 ft. long  
 ■ 125 VAC  
 ■ 15 amp  
 ▼ OEM Reference  
 DEKA IMP-9409  
 DEKA SA4081



Part Number - 396351  
**Replacement Power Cord AC**  
 ■ For use with Delta Q On-Board Charger

⚠ **WARNING:** Cancer - [www.P65Warnings.ca.gov](http://www.P65Warnings.ca.gov)



Part Number - 142669  
**Replacement Power Cord**  
 ■ 10 ft. long  
 ■ 300v  
 ■ 15 amp, 15 amp plug



Part Number - 396354  
**Replacement Power Cord**  
 ■ 18" of straight cord, female end to spiral cord  
 ■ For Zivan charger  
 ▼ OEM Reference  
 GNB V04ZIVANPLUG

### Charger Cords

- 10AWG UL rated cable available in 5' and 10' cord lengths
- Use with V-HFM and V-HFE series chargers
- Nema rated Locking Plugs

| Part Number | Description                               | AC Input Voltage         |
|-------------|---|--------------------------|
| 300480-205  | Power Cord Assembly 5' 10AWG/Nema L1620P  | 480V - 3 phase           |
| 300480-210  | Power Cord Assembly 10' 10AWG/Nema L1620P | 480V - 3 phase           |
| 300480-215  | Power Cord Assembly 15' 10AWG/Nema L1620P | 480V - 3 phase           |
| 300480-305  | Power Cord Assembly 5' 10 AWG/Nema L1630P | 480V - 3 phase           |
| 300480-310  | Power Cord Assembly 10' 10AWG/Nema L1630P | 480V - 3 phase           |
| 300208-205  | Power Cord Assembly 5' 10AWG/Nema L1530P  | 208V/240V - 3 phase      |
| 300208-210  | Power Cord Assembly 10' 10AWG/Nema L1530P | 208V/240V - 3 phase      |
| 300208-305  | Power Cord Assembly 5' 10AWG/Nema L1630P  | 208V/240V - single phase |
| 300208-310  | Power Cord Assembly 10' 10AWG/Nema L630P  | 208V/240V - single phase |

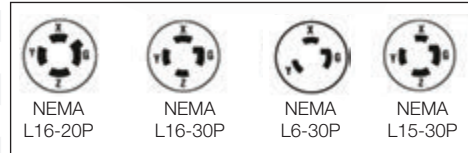

**Cable Size Matrix**

| HFM <sup>3</sup> Model No. | Cable Size | Connector Options |       |        |        |        |        |      |      |
|----------------------------|------------|-------------------|-------|--------|--------|--------|--------|------|------|
|                            |            | 175SB             | 350SB | 175SBX | 350SBX | 160SBE | 320SBE | A160 | A320 |
| FS3-MP342-1                | 1/0        | X                 | X     | X      | X      | X      | X      | X    | X**  |
| FS3-MP342-2                | 3/0        |                   | X     |        | X      |        | X      |      | X**  |
| FS3-MP342-3                | 4/0        |                   | X     |        | X      |        | X      |      | X**  |
| FS3-MP344-1                | 1/0        | X                 | X     | X      | X      | X      | X      | X    | X**  |
| FS3-MP344-2                | 3/0        |                   | X     |        | X      |        | X      |      | X**  |
| FS3-MP344-3                | 4/0        |                   | X     |        | X      |        | X      |      | X**  |
| FS4-MP344-4                | 4/0        |                   | X*    |        |        |        |        |      |      |
| FS4-MP344-5                | 4/0        |                   | X*    |        |        |        |        |      |      |
| FS4-MP344-6                | 4/0        |                   | X*    |        |        |        |        |      |      |
| FS4-MP346-4                | 4/0        |                   | X*    |        |        |        |        |      |      |
| FS4-MP346-5                | 4/0        |                   | X*    |        |        |        |        |      |      |
| FS4-MP346-6                | 4/0        |                   | X*    |        |        |        |        |      |      |
| FS6-MP344-4                | 4/0        |                   | 2X    |        | 2X     |        | 2X     |      | 2X   |
| FS6-MP344-5                | 4/0        |                   | 2X    |        | 2X     |        | 2X     |      | 2X   |
| FS6-MP344-6                | 4/0        |                   | 2X    |        | 2X     |        | 2X     |      | 2X   |

\*FS4-4, 5, 6 uses 350SB with 4/0 Crimp Lug

\*\*A320 is not recommended for Lithium. See Lithium Ion Charge Harness below.

| HFE Model No. | Cable Size | Connector Options |       |        |        |        |        |      |      |
|---------------|------------|-------------------|-------|--------|--------|--------|--------|------|------|
|               |            | 175SB             | 350SB | 175SBX | 350SBX | 160SBE | 320SBE | A160 | A320 |
| FS3-MP124-2   | 1/0        | X                 | X     | X      | X      | X      | X      | X    | X    |
| FS3-MP324-2   | 1/0        | X                 | X     | X      | X      | X      | X      | X    | X    |
| FS3-MP124-3   | 1/0        | X                 | X     | X      | X      | X      | X      | X    | X    |
| FS3-MP324-3   | 1/0        | X                 | X     | X      | X      | X      | X      | X    | X    |
| FS3-MP136-2   | 1/0        | X                 | X     | X      | X      | X      | X      | X    | X    |
| FS3-MP336-2   | 1/0        | X                 | X     | X      | X      | X      | X      | X    | X    |
| FS3-MP336-3   | 1/0        | X                 | X     | X      | X      | X      | X      | X    | X    |
| FS3-MP348-2   | 1/0        | X                 | X     | X      | X      | X      | X      | X    | X    |
| FS3-MP348-3   | 1/0        | X                 | X     | X      | X      | X      | X      | X    | X    |

| HFM Model No. | Cable Size | Connector Options |       |        |        |        |        |      |      |
|---------------|------------|-------------------|-------|--------|--------|--------|--------|------|------|
|               |            | 175SB             | 350SB | 175SBX | 350SBX | 160SBE | 320SBE | A160 | A320 |
| FS3-MP130-2   | 1/0        | X                 | X     | X      | X      | X      | X      | X    | X    |
| FS3-MP130-3   | 1/0        | X                 | X     | X      | X      | X      | X      | X    | X    |

NOTE: 2 connector housings are required to assemble with the standard size cable and 4 connector housings with the dual (2X) cable assemblies.

**Steps to determine correct cable and connector housing:** 1. Reference the Cable Size Matrix Chart to identify your charger model and the corresponding cable size. 2. Reference the Chart to make the connector housing selection (typically customer/application specific). 3. All cable assemblies will require the 078723-001 gray 350SB connector housing for the charger end. (If dual cables are ordered for fast charging, then 2 of the gray SB connectors will be required.) 4. Selection of the other connector housing(s) is based on the cable specified per the customer's location. Example: FS9-MP330-8 with 350SBX (Blue) 15 ft. cable — Cable Assembly Part Number: 39653X-350-15 – qty 2; Connector Housing Part Number: 078723-001 – qty 2; 340090-002 – qty 2.

**Lithium Ion Charge Harnesses**

All Lithium Ion Charge Harnesses come assembled with 4/0 cable, Schaltbau LV400, SB350 and CAN Communication Line.



| Harness Part Number | Cable Length |
|---------------------|--------------|
| 164401-400-08       | 8 FT         |
| 164401-400-10       | 10 FT        |
| 164401-400-15       | 15 FT        |
| 164401-400-20       | 20 FT        |
| 164401-400-25       | 25 FT        |

⚠ WARNING: Cancer and reproductive harm - [www.P65Warnings.ca.gov](http://www.P65Warnings.ca.gov)

# Battery Cable Assemblies

## Cable Assemblies\*

| DC Cable Number | Cable Length | Cable Size | Contact Tips for Connector Housing Battery End |
|-----------------|--------------|------------|--|
|-----------------|--------------|------------|--|

|               |        |     |       |
|---------------|--------|-----|-------|
| 396500-175-01 | 8 ft.  | 1/0 | 175SB |
| 396500-175-15 | 15 ft. | 1/0 | 175SB |
| 396500-175-20 | 20 ft. | 1/0 | 175SB |
| 396500-175-25 | 25 ft. | 1/0 | 175SB |

|               |        |     |                  |
|---------------|--------|-----|------------------|
| 39651X-175-01 | 8 ft.  | 1/0 | 175SBX or 160SBE |
| 39651X-175-15 | 15 ft. | 1/0 | 175SBX or 160SBE |
| 39651X-175-20 | 20 ft. | 1/0 | 175SBX or 160SBE |
| 39651X-175-25 | 25 ft. | 1/0 | 175SBX or 160SBE |

|               |        |     |       |
|---------------|--------|-----|-------|
| 396500-350-01 | 8 ft.  | 1/0 | 350SB |
| 396500-350-15 | 15 ft. | 1/0 | 350SB |
| 396500-350-20 | 20 ft. | 1/0 | 350SB |
| 396500-350-25 | 25 ft. | 1/0 | 350SB |

|               |        |     |       |
|---------------|--------|-----|-------|
| 396530-350-01 | 8 ft.  | 3/0 | 350SB |
| 396530-350-15 | 15 ft. | 3/0 | 350SB |
| 396530-350-20 | 20 ft. | 3/0 | 350SB |
| 396530-350-25 | 25 ft. | 3/0 | 350SB |

|               |        |     |       |
|---------------|--------|-----|-------|
| 396540-350-01 | 8 ft.  | 4/0 | 350SB |
| 396540-350-15 | 15 ft. | 4/0 | 350SB |
| 396540-350-20 | 20 ft. | 4/0 | 350SB |
| 396540-350-25 | 25 ft. | 4/0 | 350SB |

|               |        |     |                  |
|---------------|--------|-----|------------------|
| 39650X-350-01 | 8 ft.  | 1/0 | 350SBX or 320SBE |
| 39650X-350-15 | 15 ft. | 1/0 | 350SBX or 320SBE |
| 39650X-350-20 | 20 ft. | 1/0 | 350SBX or 320SBE |
| 39650X-350-25 | 25 ft. | 1/0 | 350SBX or 320SBE |

|               |        |     |                  |
|---------------|--------|-----|------------------|
| 39653X-350-01 | 8 ft.  | 3/0 | 350SBX or 320SBE |
| 39653X-350-15 | 15 ft. | 3/0 | 350SBX or 320SBE |
| 39653X-350-20 | 20 ft. | 3/0 | 350SBX or 320SBE |
| 39653X-350-25 | 25 ft. | 3/0 | 350SBX or 320SBE |

|               |        |     |                  |
|---------------|--------|-----|------------------|
| 39654X-350-01 | 8 ft.  | 4/0 | 350SBX or 320SBE |
| 39654X-350-15 | 15 ft. | 4/0 | 350SBX or 320SBE |
| 39654X-350-20 | 20 ft. | 4/0 | 350SBX or 320SBE |
| 39654X-350-25 | 25 ft. | 4/0 | 350SBX or 320SBE |

|               |        |     |      |
|---------------|--------|-----|------|
| 396510-160-01 | 8 ft.  | 1/0 | A160 |
| 396510-160-15 | 15 ft. | 1/0 | A160 |
| 396510-160-20 | 20 ft. | 1/0 | A160 |
| 396510-160-25 | 25 ft. | 1/0 | A160 |

|               |        |     |      |
|---------------|--------|-----|------|
| 396500-320-01 | 8 ft.  | 1/0 | A320 |
| 396500-320-15 | 15 ft. | 1/0 | A320 |
| 396500-320-20 | 20 ft. | 1/0 | A320 |
| 396500-320-25 | 25 ft. | 1/0 | A320 |

|               |        |     |      |
|---------------|--------|-----|------|
| 396530-320-01 | 8 ft.  | 3/0 | A320 |
| 396530-320-15 | 15 ft. | 3/0 | A320 |
| 396530-320-20 | 20 ft. | 3/0 | A320 |
| 396530-320-25 | 25 ft. | 3/0 | A320 |

|               |        |     |      |
|---------------|--------|-----|------|
| 396540-320-01 | 8 ft.  | 4/0 | A320 |
| 396540-320-15 | 15 ft. | 4/0 | A320 |
| 396540-320-20 | 20 ft. | 4/0 | A320 |
| 396540-320-25 | 25 ft. | 4/0 | A320 |

## Connector Housing

| Connectors | Description                    |
|------------|--------------------------------|
| 078723-002 | 175SB Connector Housing Gray   |
| 078723-004 | 175SB Connector Housing Yellow |
| 078723-007 | 175SB Connector Housing Red    |
| 078723-008 | 175SB Connector Housing Blue   |

| Connectors | Description                     |
|------------|---------------------------------|
| 340028-001 | 175SBX Gray Connector Housing   |
| 340028-002 | 175SBX Blue Connector Housing   |
| 340028-004 | 175SBX Yellow Connector Housing |
| 340028-005 | 175SBX Red Connector Housing    |
| 108801-005 | 160SBE Red Connector Housing    |
| 108801-011 | 160SBE Gray Connector Housing   |
| 108801-012 | 160SBE Blue Connector Housing   |

| Connectors | Description                    |
|------------|--------------------------------|
| 078723-001 | 350SB Connector Housing Gray   |
| 078723-003 | 350SB Connector Housing Red    |
| 078723-006 | 350SB Connector Housing Blue   |
| 078723-009 | 350SB Connector Housing Yellow |
| 078723-011 | 350SB Connector Housing Green  |
| 078723-012 | 350SB Connector Housing Black  |

| Connectors | Description                     |
|------------|---------------------------------|
| 340090-001 | 350SBX Connector Housing Gray   |
| 340090-002 | 350SBX Connector Housing Blue   |
| 340090-003 | 350SBX Connector Housing Black  |
| H24985-502 | 350SBX Connector Housing Red    |
| 340350-005 | 350SBX Connector Housing Green  |
| 340350-007 | 350SBX Connector Housing Yellow |
| 108801-001 | 320SBE Gray Connector Housing   |
| 108801-002 | 320SBE Green Connector Housing  |
| 108801-003 | 320SBE Red Connector Housing    |
| 108801-006 | 320SBE Blue Connector Housing   |
| 108801-008 | 320SBE Yellow Connector Housing |
| 108801-010 | 320SBE Black Connector Housing  |

| Connectors | Description                 |
|------------|-----------------------------|
| 341227-115 | A160 male connector housing |

| Connectors | Description                 |
|------------|-----------------------------|
| 340320-112 | A320 male connector housing |
| 340320-312 | A320 male connector housing |
| 340320-412 | A320 male connector housing |

\*Connector housings need to be ordered separately.



# Battery Room Checklist

Thank you for allowing me to conduct a survey of your current forklift battery charging and maintenance resources. The items noted below are products we recommend you consider adding or updating within your current charging area to help support proper battery maintenance, charging and safe handling. These products and many more parts and supplies can be found in the attached One Source Lift Truck Parts Catalog.

If you have any questions regarding these recommendations, or about placing an order with Crown Equipment, please contact me:

Name \_\_\_\_\_

Phone \_\_\_\_\_

Email \_\_\_\_\_

## BATTERY SERVICE SUPPLIES

| Part No.                            | Description  |
|-------------------------------------|--|
| <input type="checkbox"/> 079528     | Koorsen 2.5 lb. Fire Extinguisher, ABC*                          |
| <input type="checkbox"/> 365466     | NuTend 16 Gallon Eye Wash Station*                               |
| <input type="checkbox"/> 365474     | Water Additive, Case/12*   |
| <input type="checkbox"/> 365468     | ProWorks® Eye Wash Station, 1 kit*                               |
| <input type="checkbox"/> 365469-001 | ProWorks® Replacement Bottle of Eye Wash*                        |
| <input type="checkbox"/> 300035     | Battery Spill Kit*   |
| <input type="checkbox"/> 365260-001 | Apron, Black*  |
| <input type="checkbox"/> 300042     | Faceshield*  |
| <input type="checkbox"/> 300041     | Headgear*  |
| <input type="checkbox"/> 300044     | Green Acid Resistant Glove, Nitrile*                             |
| <input type="checkbox"/> 300403-050 | Reusable Battery Acid Floor and Counter Mat, 3 ft. x 50 ft.*     |
| <input type="checkbox"/> 300421     | Battery Protector® Acid Spill Absorber and Neutralizer, 5 gal.*  |
| <input type="checkbox"/> 300421-030 | Battery Protector® Acid Spill Absorber and Neutralizer, 30 gal.* |
| <input type="checkbox"/> 363124-001 | Crown Battery Cleaner, 18 oz.                                    |
| <input type="checkbox"/> 363125-001 | Crown Battery Protector, 14 oz.                                  |
| <input type="checkbox"/> 363133-001 | QuickCable Black Battery Reconditioner, 12 oz.                   |

\*Strongly suggested per OSHA standards

## CHARGER ACCESSORIES

| Part No.                               | Description                |
|--|----------------------------|
| <input type="checkbox"/> 396600-014-01 | Rail Stop*                 |
| <input type="checkbox"/> 396568        | Magnet Mount Cable Holder  |
| <input type="checkbox"/> 300038        | Battery Pogo Stick, 39 in. |
| <input type="checkbox"/> 309820        | Tender Kit                 |
| <input type="checkbox"/> 300460        | L-Bracket, Steel, Black    |
| <input type="checkbox"/> 396547-002    | Bracket, Steel, Black      |
| <input type="checkbox"/> 300038-005    | Tool Balance Swivel Mount  |
| <input type="checkbox"/> 300038-002    | Cable Retractor            |
| <input type="checkbox"/> 300038-12D    | Heavy Duty Pogo Stick      |

## WATERING GUN

| Part No.                        | Description                   |
|---------------------------------|-------------------------------|
| <input type="checkbox"/> 300236 | V-Force® Battery Watering Gun |

## FLOAT SYSTEM - FILL OPTIONS

| Part No.                            | Description                      |
|-------------------------------------|----------------------------------|
| <input type="checkbox"/> 300224-147 | 120 V AC 10 Gallon Watering Cart |
| <input type="checkbox"/> 300224-090 | 120 V DC 10 Gallon Watering Cart |
| <input type="checkbox"/> 300226-005 | V-Force® Water Deionizer         |

## BATTERY ACID INDICATORS

| Part No.                            | Description                   |
|-------------------------------------|-------------------------------|
| <input type="checkbox"/> 340011-012 | Smart Blinky Pro, 2.35 in.    |
| <input type="checkbox"/> 340011-015 | Smart Blinky Pro, 5 in.       |
| <input type="checkbox"/> 340011-007 | Blinky, 2.35 in.              |
| <input type="checkbox"/> 340011-008 | Blinky, 5 in.                 |
| <input type="checkbox"/> 340011-009 | Smart Blinky, 2.35 in.        |
| <input type="checkbox"/> 340011-010 | Smart Blinky Remote, 2.35 in. |
| <input type="checkbox"/> 340011-011 | Smart Blinky, 5 in.           |

## BATTERY MANAGEMENT SYSTEM

| Part No.                            | Description                         |
|-------------------------------------|-------------------------------------|
| <input type="checkbox"/> 340640     | V-Force® Small Fleet BMS Controller |
| <input type="checkbox"/> 300314-SU6 | Sentinel with Blue Light            |

## SAFETY BOOTS

| Part No.                            | Description                      |
|-------------------------------------|----------------------------------|
| <input type="checkbox"/> 300413-050 | V-Force® Safety Boot, SB, 50 A   |
| <input type="checkbox"/> 300413-175 | V-Force® Safety Boot, SB, 175 A  |
| <input type="checkbox"/> 300413-350 | V-Force® Safety Boot, SB, 350 A  |
| <input type="checkbox"/> 300462-175 | V-Force® Safety Boot, SBX, 175 A |
| <input type="checkbox"/> 300462-350 | V-Force® Safety Boot, SBX, 350 A |

# Keep Charging, Stop Changing

## with V-Force® Lithium-Ion Technology

Lithium-ion technology is revolutionizing the electric forklift industry. Compared to lead-acid batteries, lithium-ion systems deliver game-changing advantages, especially for multi-shift operations, virtually eliminating routine battery maintenance and mid-shift battery changes.



### Low Maintenance, Lower Costs

Eliminates the time consuming tasks associated with lead-acid batteries including battery changes, watering or special battery rooms.



### No Battery Swapping

One lithium-ion battery can handle one shift or multiple shifts with no need for extra batteries or the downtime required to change them.



### Increased Safety

Zero emissions during charging means no gassing and no exposure to harmful acids and vapors. A multi-level safety architecture provides complete protection during use.



### Longer Life

Lithium-ion batteries outperform lead-acid batteries, saving replacement and service costs over time.



### Improved Efficiency

Achieve greater efficiency, higher sustained voltage properties as the battery discharges.



### True Opportunity Charging

Increase uptime with periodic opportunity charging, enabling one lithium-ion battery to achieve more run time in a 24-hour period.



Contact your [Regional Power Motive Specialist](#) for more details.

**CROWN**



## V-Force® Lithium-Ion Energy Storage Systems

The V-Force® Lithium-Ion ESS is fully integrated with a full line of Crown lift trucks for flexibility, scalability and convenience.



- **Lower Maintenance, Lower Costs** – Eliminates the time-consuming tasks associated with lead-acid batteries including battery changes, watering or special battery rooms.
- **Improved Efficiency** – Achieve greater efficiency, higher sustained voltage properties as the battery discharges.
- **True Opportunity Charging** – Increase uptime with periodic opportunity charging, enabling one lithium-ion battery to achieve more run time in a 24-hour period.
- **No Battery Swapping** – One lithium-ion battery can handle one shift or multiple shifts with no need for extra batteries or the downtime required to change them.
- **Increased Safety** – Zero emissions during charging means no gassing and no exposure to harmful acids and vapors. A multi-level safety architecture provides complete protection during use.
- **Longer Life** – Lithium-ion batteries outperform lead-acid batteries, saving replacement and service costs over time.

*Note: Communication/Diagnostic Kit (Part No. 165064) includes Communication Y cable and Peak Can Dongle. Communication/Diagnostic Cable Only (Part No. 165541-001)*



## V-Force Lithium Ion Energy Storage Systems for WP Series Pallet Truck

The V-Force Lithium Ion Pack's design supports superior functionality to promote easier, more efficient use



- Integrated on-board charger
- Fully integrated with truck display showing battery discharge levels and warnings
- Connection to the Early Warning System alerts the operator before the battery stops truck operation
- The battery management system extends battery life by preventing abuse and operation outside warranted conditions
- **Longer Life** - Can undergo considerably more charge/discharge cycles than lead acid batteries before their capacity is significantly reduced
- **Extended Run Time** - Higher energy density, often resulting in longer run time versus lead acid batteries
- **More Efficient** - More energy efficient when charging and discharging, reducing carbon footprint
- **Safer and Easier to Maintain** - Maintenance free, eliminating the need for battery watering and avoiding the exposure of your employees to harmful acid and vapors
- CE compliant and UL Listed
- Warranty - 5 years from date of sale, or when reaching Maximum Ah Throughput, which is 2000 cycles x 80% of the battery capacity

*Note: Authorization of Modification is needed for trucks not already modified for lithium ion batteries by Crown Equipment.*

**Communication Accessory Kit (P.N. 164423-001):** Includes: 24V Jumper Plug for deeply discharged recovery. Communication Peak Can Dongle, Communication Cable for downloading data and diagnostics, and Replacement Comms Cable.

**Communication Accessory Kit Less Dongle (P.N. 164423)**

**Communication Cable Only (P.N. 164469)**

**24V Jumper Plug (P.N. 164424):** For deeply discharged recovery.

**Power Cable NEMA/CEE7 14AWG 2M BLK (P.N. 300805-042)**



▲ **WARNING:** Cancer and reproductive harm - [www.P65Warnings.ca.gov](http://www.P65Warnings.ca.gov)



# A WINNING POWER COMBINATION

A time-proven, affordable power source, lead-acid batteries – matched with the right Crown lift trucks and V-Force high-frequency chargers – keep all light- and heavy-duty cycle applications running with dependable productivity. Crown service provides an extra boost of power to help keep fleets on the go.



Discover how V-Force Lead-Acid Batteries provide reliable, power across a range of duty cycles:

### Proven Technology



Lead-acid batteries continue to be a tried and true, cost-effective source of lift truck power for a wide range of material handling applications, from single to multi-shift.

### Multiple Solutions



Crown offers a choice of traditional flat plate lead-acid or tubular lead-acid batteries, along with a selection of chargers, to fit specific duty cycles, maintenance requirements and material handling needs.

### Total Solutions Provider



Work with a Crown representative to find the right integrated solution – lift truck, battery and charger – to deliver the performance and efficiency needed for your material handling application and fleet.

### Accessories & Supplies



Crown also offers a wide range of battery and charger accessories, including battery connectors, watering accessories, battery acid indicators, monitoring devices, service tools, and charger stands and cords.

### Long-Term Crown Support



You can count on the Crown network of trained technicians to service your forklifts and V-Force batteries and chargers to avoid unplanned downtime and increase productivity.

Choose **Crown's V-Force Lead-Acid Batteries** for dependable power and productivity in your forklift fleet.

Contact your local Crown dealer or visit [crown.com](http://crown.com).







## V-Force Lead Acid Batteries

With a lower initial cost than other battery technologies, V-Force lead acid batteries can provide a cost-effective power solution for a range of duty cycles, including multi-shift operations.



### Flat Plate Lead-Acid Batteries

This traditional time-tested battery design for electric lift trucks features:

- Robust design for durability in rough applications
- More active material for greater performance and capacity
- Heavy grid construction to limit corrosion
- Exclusive five-layer wrap to minimize positive active material shedding
- Lower initial cost



### Tubular Lead-Acid Batteries

This advanced lead-acid technology increases the surface area of active material, improving productivity and extending runtimes for multi-shift applications.

- Flexible bolt-on inter-cell cable connectors for easy maintenance, higher current delivery with less internal resistance and lower operating temperatures
- Fully insulated flex connectors and post bolts to prevent arcing and lead exposure
- V-LA1120 Series - Standard low maintenance cells that hold more water, reducing watering frequency and maintenance costs
- V-LA1130 Series - High capacity cells for increased run time for high duty cycle applications

**WARNING:** Cancer and reproductive harm - [www.P65Warnings.ca.gov](http://www.P65Warnings.ca.gov)

# Deep Cycle Batteries

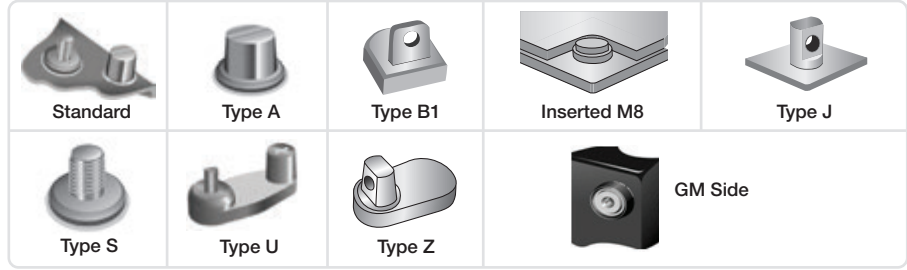

BATTERY AND CHARGER

| Part Number            | Pallet Part Number | BCI Group | RC Min     | 20Hr Rate (AH) | Crown Applications             | Terminal Style | Weight (lb) | LxWxH (in)**     | Liquid Level Indicator |
|------------------------|--------------------|-----------|------------|----------------|--------------------------------|----------------|-------------|------------------|------------------------|
| <b>Flooded 6 Volt</b>  |                    |           |            |                |                                |                |             |                  |                        |
| 345006-095*            |                    | 1         | 130 @ 25 A | 130            |                                | Type A         | 31          | 9.08x6.91x8.75   | No                     |
| 071419-001             |                    | 1         | 180 @ 75 A | 100            | M, B, ST3000                   | Type A         | 32          | 9.00x6.78x8.88   | No                     |
| 371419-002***          |                    | 1         | 130 @ 75 A | 100            |                                | Type A         | 34          | 9.03x6.86x8.69   | No                     |
| 345006-180             | 345006-180-30      | GC2       | 90 @ 75 A  | 180            |                                | Type S         | 55          | 10.25x7.13x10.75 | No                     |
| 072798-001             |                    | GC2       | 100 @ 75 A | 190            | M                              | Type A         | 59          | 10.25x7.12x10.62 | No                     |
| 345006-200-01          |                    | GC2       | 105 @ 75 A | 200            |                                | Standard       | 60          | 10.25x7.13x10.75 | No                     |
| 345205                 | 345205-030         | GC2       | 389 @ 25 A | 205            |                                | Standard       | 56          | 10.25x7.06x9.88  | No                     |
| 345225                 | 345225-030         | GC2       | 115 @ 75 A | 225            | GPW, WAVE                      | Standard       | 63          | 10.25x7.13x10.75 | No                     |
| 092222-002***          |                    | GC2       | 115 @ 75 A | 225            |                                | Standard       | 63          | 10.75x7.13x10.75 | No                     |
| 345006-235             | 345006-235-30      | GC2       | 125 @ 75 A | 235            |                                | Standard       | 68          | 10.25x7.13x10.75 | No                     |
| 345006-240             |                    | Euro GC   | 125 @ 75 A | 240            |                                | Type A         | 64          | 9.63x7.50x10.75  | No                     |
| 120194-001             | 120194-001-30      | GC2H      | 145 @ 75 A | 245            | WAVE                           | Type S         | 73          | 10.25x7.13x11.5  | No                     |
| 345006-250             |                    | 901       | 140 @ 75 A | 250            |                                | Standard       | 72          | 11.75x7.19x11.25 | No                     |
| 345006-275             |                    | 901       | 155 @ 75 A | 275            |                                | Standard       | 76          | 11.75x7.19x11.25 | No                     |
| 345006-305             |                    | 902       | 175 @ 75 A | 305            |                                | Standard       | 92          | 12.19x7.19x14.13 | Yes                    |
| 345006-325             |                    | 902       | 196 @ 75 A | 325            |                                | Standard       | 100         | 12.19x7.19x14.13 | Yes                    |
| 345006-350             |                    | 903       | 210 @ 75 A | 350            |                                | Standard       | 112         | 12.38x7.19x16.13 | Yes                    |
| 345006-395             |                    | 903       | 225 @ 75 A | 395            |                                | Standard       | 120         | 12.38x7.19x16.13 | Yes                    |
| 345006-430             |                    | 903       | 240 @ 75A  | 430            |                                | Standard       | 122         | 12.38x7.19x16.13 | Yes                    |
| <b>Flooded 8 Volt</b>  |                    |           |            |                |                                |                |             |                  |                        |
| 345008-150             |                    | GC8       | 250 @ 25 A | 150            |                                | Type S         | 60          | 10.31x7.06x9.72  | No                     |
| 345008-165             |                    | GC8       | 75 @ 75 A  | 165            |                                | Type S         | 64          | 10.31x7.13x10.75 | No                     |
| <b>Flooded 12 Volt</b> |                    |           |            |                |                                |                |             |                  |                        |
| 345012-085             |                    | 24        | 140 @ 25 A | 95             |                                | Standard       | 50          | 10.88x6.75x9.38  | No                     |
| 345012-090             |                    | 24        | 140 @ 25 A | 85             |                                | Standard       | 39          | 10.19x6.81x9.50  | No                     |
| 345012-115             |                    | 27        | 170 @ 25 A | 115            |                                | Standard       | 58          | 12.63x6.75x9.38  | Yes                    |
| 345012-140             |                    | 31        | 200 @ 25 A | 130            |                                | Standard       | 66          | 13.00x6.75x9.38  | Yes                    |
| 345012-150             |                    | GC12      | 61 @ 75 A  | 150            |                                | Standard       | 81          | 12.92x7.06x9.70  | No                     |
| 345012-155             |                    | 920       | 68 @ 75 A  | 155            |                                | Type A & S     | 87          | 13.63x6.75x12.25 | No                     |
| 345012-185             |                    | 921       | 85 @ 75 A  | 185            |                                | Type S & Z     | 108         | 15.50x7.00x14.50 | Yes                    |
| 345012-210             |                    | 921       | 110 @ 75 A | 210            |                                | Standard       | 131         | 15.50x7.00x14.50 | Yes                    |
| 345012-215             |                    | 921       | 118 @ 75 A | 215            |                                | Standard       | 128         | 15.50x7.00x14.63 | Yes                    |
| <b>Sealed 6 Volt</b>   |                    |           |            |                |                                |                |             |                  |                        |
| 345006-200 (Gell)      |                    | GC2       | 105 @ 75 A | 200            |                                | Standard       | 67          | 10.24x7.13x10.61 | No                     |
| 156131                 | 156131-030         | 27        | 195 @ 25 A | 220            | WAVE                           | Inserted M6    | 64.9        | 12.09x6.61x8.39  | No                     |
| 157890                 | 157890-021         | 27        | 226 @ 25 A | 220            | WP2000, WP2300, ST3000, SX3000 | Inserted M6    | 90          | 12.13x6.69x10.83 | No                     |
| 345205-220             |                    | GC2       | 125 @ 75 A | 220            |                                | Standard       | 70          | 10.24x7.13x10.61 | No                     |
| <b>Sealed 12 Volt</b>  |                    |           |            |                |                                |                |             |                  |                        |
| 345012-018-0S          |                    | N/A       | 10 @ 25 A  | 18             |                                | Type B1        | 11.61       | 7.13x3.03x6.57   | No                     |
| 345012-026-0S          |                    | N/A       | 14 @ 25 A  | 26             |                                | Type B1        | 17.14       | 6.50x6.93x5.00   | No                     |
| 345012-055-0S          |                    | 22NF      | 60 @ 75 A  | 55             |                                | Type Z         | 37          | 9.00x5.43x8.19   | No                     |
| 345012-075             |                    | 24        | 145 @ 25 A | 75             |                                | Type Z         | 49          | 10.2x6.61x9.06   | No                     |
| 345012-075-01          |                    | 24        | 140 @ 25 A | 75             |                                | Insert M8      | 49          | 10.25x6.61x8.31  | No                     |
| 345012-100-0S          |                    | 27        | 175 @ 25 A | 100            |                                | Type Z         | 60          | 12.09x6.65x8.31  | No                     |
| 345012-110             |                    | 31        | 210 @ 25A  | 110            |                                | Standard       | 76          | 12.96x6.81x9.18  | No                     |
| 345012-100-0U          |                    | 27        | 175 @ 25A  | 100            |                                | Standard       | 60          | 12.09x6.65x8.31  | No                     |
| 345012-031-SS          |                    | 31        | 175 @ 25 A | 120            |                                | Standard       | 57          | 13.00x6.75x9.38  | No                     |
| 345012-035-0S          |                    | U1        | N/A        | 35             |                                | Type Z         | 22.33       | 7.68x5.12x6.10   | No                     |
| 345012-135-0S          |                    | 920       | 85 @ 75 A  | 135            |                                | Standard       | 92.5        | 13.39x6.81x11.14 | No                     |

\*Maintenance free    \*\*Height includes posts    \*\*\*Moist/Dry Battery

▲ **WARNING:** Cancer and reproductive harm - [www.P65Warnings.ca.gov](http://www.P65Warnings.ca.gov)

# Starter Batteries



BATTERY AND CHARGER

| Part Number            | Pallet Part Number | BCI Group | RC-Reserve Capacity @ 25 Amps | CCA  | Terminal Style   | Weight (lb) | LxWxH (in)**      |
|------------------------|--------------------|-----------|-------------------------------|------|------------------|-------------|-------------------|
| <b>Flooded 6 Volt</b>  |                    |           |                               |      |                  |             |                   |
| 345004-950             |                    | 4H-950    | 300                           | 950  | Type A           | 49          | 12.63x7.00x9.50   |
| <b>Flooded 12 Volt</b> |                    |           |                               |      |                  |             |                   |
| 345004-100             |                    | 4D-1000   | 300                           | 1000 | Type A           | 100         | 20.63x8.63x10.00  |
| 345004-130             |                    | 4D-1300   | 375                           | 1300 | Type A           | 52          | 20.63x8.63x10.00  |
| 345005-850***          |                    | 4DLT      | 255                           | 850  | Type A           | 87          | 20.44x8.13x8.00   |
| 345022                 | 345022-060         | 22NF      | 65                            | 400  | Type A           | 27          | 9.50x5.56x9.00    |
| 345024                 | 345024-042         | 24        | 85                            | 550  | Type A           | 39          | 10.25x6.75x9.00   |
| 345024-675             |                    | 24        | 90                            | 675  | Type A           | 39          | 10.25x6.75x9.00   |
| 345024-675-01          | 345024-675-42      | 24F*      | 105                           | 675  | Type A           | 42          | 10.25x6.75x9.00   |
| 345025-500             |                    | 25        | 100                           | 500  | Type A           | 35          | 9.63x7.00x8.88    |
| 345026-500             |                    | 26/26R    | 65                            | 500  | Reverse          | 29          | 8.25x6.81x8.25    |
| 345027-710             |                    | 27        | 120                           | 710  | Type A           | 45          | 12.00x6.75x9.00   |
| 345027-800             | 345027-800-36      | 27        | 125                           | 800  | Type A           | 51          | 12.00x6.63x9.00   |
| 345029-340             |                    | 29NF      | 90                            | 340  | Type A           | 39          | 13.00x5.50x8.88   |
| 345031-625             |                    | 31        | 135                           | 625  | Type S           | 53          | 12.94x6.75x9.44   |
| 345031-775             |                    | 31        | 170                           | 775  | Type A           | 58          | 12.94x6.75x9.44   |
| 345031-775-01          |                    | 31        | 170                           | 775  | Type S           | 58          | 12.94x6.75x9.44   |
| 345031-1000            |                    | 31        | 185                           | 1000 | Type S           | 61          | 12.94x6.75x9.44   |
| 345031-1000-A          |                    | 31        | 185                           | 1000 | Type A           | 61          | 12.94x6.75x9.44   |
| 345031-1000-STD        |                    | 31        | 190                           | 1000 | Standard         | 60          | 13.00x6.75x9.38   |
| 345010-960***          |                    | 31A       | 180                           | 960  | Type A           | 61          | 13.00x6.75x9.44   |
| 345034-675             |                    | 34        | 105                           | 675  | Type A           | 42          | 10.25x6.81x8.19   |
| 345034-675-01          |                    | 34R*      | 105                           | 675  | Type A           | 42          | 10.25x6.81x8.19   |
| 345034-800             |                    | 34/78     | 90                            | 690  | Type A / GM Side | 39          | 10.25x6.88x8.19   |
| 345035-540             |                    | 35        | 90                            | 540  | Type A           | 37          | 9.13x6.75x8.63    |
| 345036-675-01          |                    | 36R       | 120                           | 650  | SAE / Type A     | 42          | 10.25x7.25x7.88   |
| 065202                 |                    | 45        | 75                            | 500  | Type A           | 29          | 9.25x5.50x8.88    |
| 347047-600             |                    | 47        | 95                            | 600  | Type A           | 34          | 9.63x7.00x6.94    |
| 345007-730***          |                    | 48/L3     | 105                           | 730  | Type A           | 40          | 11.00x6.88x7.50   |
| 345011-800***          |                    | 49/93     | 165                           | 800  | Type A           | 48          | 13.94x6.88x7.50   |
| 345051-450             |                    | 51        | 85                            | 450  | Type A           | 28          | 9.38x5.00x8.75    |
| 345051-450-OR          |                    | 51R*      | 80                            | 450  | Type A           | 28          | 9.38x5.00x8.75    |
| 345055-525             |                    | 55        | 85                            | 525  | Type A           | 29          | 8.56x6.06x8.38    |
| 345058-600             |                    | 58        | 80                            | 600  | Type A           | 32          | 9.31x7.25x7.00    |
| 345058-600-OR          |                    | 58R*      | 80                            | 600  | Type A           | 32          | 9.31x7.25x7.00    |
| 345009-590***          |                    | 59        | 90                            | 590  | Type A           | 34          | 10.13x7.50x7.63   |
| 345065-650             |                    | 65        | 100                           | 650  | Type A           | 42          | 12.06x7.44x7.56   |
| 345070-450             |                    | 70        | 65                            | 450  | GM Side          | 30          | 8.25x7.25x7.38    |
| 345075-690             |                    | 75        | 90                            | 690  | GM Side          | 37          | 9.13x7.06x7.38    |
| 345078-800             |                    | 78        | 105                           | 800  | GM Side          | 42          | 10.25x7.06x7.38   |
| 345003-400-EE          |                    | 3EE-400   | 100                           | 400  | Type A           | 44          | 19.25x4.34x8.75   |
| 345008-147-50          |                    | 8D        | 430                           | 1475 | Type A           | 132         | 20.63x10.94x10.00 |
| 065202****             |                    | 51        | 90                            | 510  | SAE / Type A     | 28          | 9.32x4.94x8.61    |
| <b>Sealed 12 Volt</b>  |                    |           |                               |      |                  |             |                   |
| 345024-080             |                    | 24        | 140                           | 500  | Standard         | 51          | 11.26x6.75x8.12   |
| 345031-110             |                    | 31        | 200                           | 650  | Standard         | 60          | 13.00x6.77x10.17  |

**Note:** See terminal types listed on page 8.16.

\*Signifies reverse post. \*\*Height includes posts. \*\*\*Includes handle. \*\*\*\*Maintenance free.

**WARNING:** Cancer and reproductive harm - [www.P65Warnings.ca.gov](http://www.P65Warnings.ca.gov)

### Battery Display Rack

| Part Number | Holds Number of Batteries |
|-------------|---------------------------|
| 345000      | 6                         |
| 345001      | 9                         |



## Retail Mobility Carts - Battery Replacement Guide

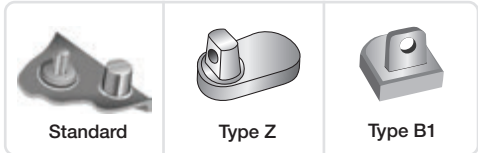

| Make/Model                        | Quantity | Crown Part No. | Voltage     | BCI Group | RC Min.   | 20Hr Rate (AH) | Terminal Style | Weight (lbs.) | LxWxH (in.)     |
|-----------------------------------|----------|----------------|-------------|-----------|-----------|----------------|----------------|---------------|-----------------|
| Amigo - Smart Shopper             | 2        | 345012-035-0S  | 12V Sealed  | U1        | N/A       | 35             | Type Z         | 23.33         | 7.68x5.12x6.10  |
| Amigo - Value Shopper             | 2        |                |             |           |           |                |                |               |                 |
| Amigo - Value Shopper XL          | 2        |                |             |           |           |                |                |               |                 |
| Invacare - Lynx 3 Wheel           | 1 or 2   |                |             |           |           |                |                |               |                 |
| Invacare - Lynx 4 Wheel           | 1 or 2   |                |             |           |           |                |                |               |                 |
| Invacare - Lynx L-3X              | 1 or 2   |                |             |           |           |                |                |               |                 |
| Invacare - Leo 3 Wheel            | 2        |                |             |           |           |                |                |               |                 |
| Invacare - Leo 4 Wheel            | 2        |                |             |           |           |                |                |               |                 |
| MartCart - 3563                   | 1 or 2   |                |             |           |           |                |                |               |                 |
| MartCart - 3500                   | 1 or 2   |                |             |           |           |                |                |               |                 |
| MartCart - 3524                   | 1 or 2   |                |             |           |           |                |                |               |                 |
| Shoprider Scooters - Sunrunner    | 2        |                |             |           |           |                |                |               |                 |
| Dane Technologies - SmartKART     | 2        |                |             |           |           |                |                |               |                 |
| Amigo - Value Shopper 34          | 2        | 345012-018-0S  | 12V Sealed  | 12V-18 Ah | 10 @ 25A  | 18             | Type B1        | 11.61         | 7.13x3.03x6.57  |
| Pride Mobility - Go-Go Elite Plus | 2        |                |             |           |           |                |                |               |                 |
| Dane Technologies - QuickKART     | 3        | 345012-085     | 12V Flooded | 24        | 160 @ 25A | 85             | Standard       | 50            | 11.13x6.75x9.38 |
| Dane Technologies - QuickKART     | 3        | 345031-730     | 12V Sealed  | 31        | 190 @ 25A |                | ¾x 16 Post     | 62.5          | 13x6.75x9.5     |

**WARNING:** Cancer and reproductive harm - [www.P65Warnings.ca.gov](http://www.P65Warnings.ca.gov)

## Starter & Deep Cycle Battery Supplier Cross Reference

Continued ▶



### Starter Battery Supplier Cross Reference

| BCI Group Size No.   | Crown Equipment | Crown Battery | Interstate Battery | East Penn Mfg Co | Exide Tech | NAPA Batteries |
|--|-----------------|---------------|--------------------|------------------|------------|----------------|
| <b>North American BCI Group Sizes - 12 Volt Automotive</b>                     |                 |               |                    |                  |            |                |
| 24   | 345024-675      | 24-675        | ---                | 624MF            | 24-72      | 7524           |
|  | 345024          | 24-550        | I-24               | 524MF            | 24-60      | 6024           |
| 24F  | 345024-675-01   | 24F-675       | I-24F              | 624FMF           | 24F-72     | 6024F          |
| 25   | 345025-500      | 25-500        | MT-25              | 525MF            | 25-72      | 5025           |
| 26   | 345026-500      | 26-500        | MT-26              | 526              | 26-60      | 6026           |
| 27   | 345027-800      | 27-800        | MTP-27             | 727MF            | 27-60      | 8427 / 7527    |
|  | 345027-710      | 27-710        | ---                | 627MF            | ---        | ---            |
| 34   | 345034-675      | 34-675        | MT-34              | 634MF            | 34-72      | 8434           |
| 34R  | 345034-675-01   | 34R-675       | MT-34R             | 634RMF           | 34R-72     | ---            |
| 35   | 345035-540      | 35-540        | MT-35              | 535MF            | 35-72      | 5035           |
| 36R  | 345036-675-01   | 36R-650       | MTP-36R            | 636RMF           | 36R-72     | 7536R          |
| 45   | 065202          | 45-500        | I-45               | 545MF            | 45-495     | 7545 / 5045    |
| 51   | 345051-450      | 51-500        | MT-51              | 551MF            | 51-450     | 5051           |
| 51R  | 345051-450-OR   | 51R-500       | MT-51R             | 551RMF           | 51R-450    | 5051R          |
| 55   | 345055-525      | 55-525        | MT-56              | 555MF            | 56-535     | 8456 / 7556    |
| 58   | 345058-600      | 58-550        | MT-58              | 658MF            | 58-540     | 8458 / 6058    |
| 58R  | 345058-600-OR   | 58R-550       | MT-58R             | 658RMF           | 58R-580    | 7558R          |
| 65   | 345065-650      | 65-650        | MT-65              | 565MF            | 65-650     | 7565           |
| 75   | 345075-690      | 75-690        | MTP-75             | 675MF            | 75-630     | 8475           |
| 78   | 345078-800      | 78-800        | MTP-78             | 778MF            | 78-770     | 8478           |
| <b>North American BCI Group Sizes - 12 Volt Automotive Dual Terminal</b>       |                 |               |                    |                  |            |                |
| 34/78  | 345034-800      | 34/78-800     | I-78DT             | 678DT            | 78DT-650   | 8434/78        |
| <b>North American BCI Group Sizes - 6, 8 &amp; 12 Volt Commercial Starting</b> |                 |               |                    |                  |            |                |
| 31   | 345031-1000A    | 31A-SD1000    | 31-MHD P           | 1131XMF          | XHP-31E    | 7235 / 7237    |
|  | 345031-1000     | 31S-SD1000    | 31-MHD S           | 1131XMF(S)       | XHP-31D    | 7234 / 7236    |
|  | 345031-775      | 31A-SD775     | 31-LHD P           | 1131PMF          | 31E-925    | 7239           |
|  | 345031-775-01   | 31S-SD775     | 31-LHD S           | 1131PMF(S)       | 31D-925    | 7238           |
| 4D   | 345004-130      | 4D-1300       | --                 | --               | --         | --             |
| 8D   | 345008-147-50   | 8D-1475       | 8D-MHD             | 908D             | 8D-1300    | 7271 / 8276    |
| 1  | 345006-095      | 1-640         | 1-VHD              | 901MF            | 1-625      | 7244           |
| 4H   | 345004-950      | 4H-950        | 4-XHD              | 904MF            | 4-975      | 7210 / 7212    |
| 3EE  | 345003-400-EE   | 3EE-400       | 3EE-VHD            | 403E             | 3EE-370    | 7250           |
| 22NF   | 345022          | 22NF-400      | SP-22NF            | 322NF            | 22NF-390   | 5022NF         |

**WARNING:** Cancer and reproductive harm - [www.P65Warnings.ca.gov](http://www.P65Warnings.ca.gov)

## Starter & Deep Cycle Battery Supplier Cross Reference



### Starter Battery Supplier Cross Reference

| BCI Group Size No.   | Crown Equipment | Crown Battery | Interstate Battery | East Penn Mfg Co | Exide Tech | NAPA Batteries |
|--|-----------------|---------------|--------------------|------------------|------------|----------------|
| <b>Severe Duty Commercial Maintenance-Free Batteries</b>     |                 |               |                    |                  |            |                |
| 24   | 345012-090      | 24SDC         | ---                | ---              | ---        | ---            |
| 51   | 065202          | 51SDC         | ---                | ---              | ---        | ---            |
| 31   | 345012-031-SS   | 31DTSDC       | ---                | DP31CS           | ---        | ---            |
| <b>European / Asian BCI Group Sizes - 12 Volt Automotive</b> |                 |               |                    |                  |            |                |
| 47/90  | 347047-600      | 47-600        | MT-47              | 647MF            | 47-600     | 8447 / 7547    |

⚠️ **WARNING:** Cancer and reproductive harm - [www.P65Warnings.ca.gov](http://www.P65Warnings.ca.gov)



### Deep Cycle Battery Supplier Cross Reference

| BCI Group Size No.  | Crown Equipment | Crown Battery | Interstate Battery | East Penn Mfg Co. | Trojan Battery | US Battery |
|---|-----------------|---------------|--------------------|-------------------|----------------|------------|
| <b>North American BCI Group Sizes - 6, 8 &amp; 12 Volt Deep Cycle</b> |                 |               |                    |                   |                |            |
| GC2   | 345006-180      | CR-180        | ---                | ---               | ---            | ---        |
|   | 345205          | CR-205        | GC2-HCL-UT         | ---               | Pacer          | US-1800    |
|   | 345006-200-01   | CR-220        | GC2-ECL-UTL        | GC-10             | T-605          | US-2000    |
|   | 345225          | CR-225        | 2300UT             | GC-15             | T-105          | US-2200    |
|   | 345006-235      | CR-240        | 2400UT             | GC-25             | T-125          | US-125     |
| Euro GC   | 345006-240      | CR-240E       | ---                | ---               | TE35           | ---        |
| GC2H  | 120194-001      | CR-260        | ---                | GC-45             | T-145          | US-145     |
| 901   | 345006-250      | CR-250        | U2500              | 8C11              | J250G          | US-250     |
|   | 345006-275      | CR-275        | ---                | 9C11              | J250P          | US-250HC   |
| 902   | 345006-305      | CR-305        | U3050              | ---               | J305E          | US-305     |
|   | 345006-325      | CR-325        | ---                | 8C6V              | J305PG         | US-305HC   |
| 903   | 345006-350      | CR-350        | UL16               | ---               | L16E           | L16E       |
|   | 345006-395      | CR-395        | ---                | 8L16              | L16G           | L16        |
| GC8   | 345008-165      | CR-165        | U8VGC              | GC8V              | T-875          | 8VGC       |
| 24  | 345012-085      | 24DC95        | SRM-24             | DC-24             | 24TMX          | 24DC       |
| 27  | 345012-115      | 27DC115       | SRM-27             | DC27              | 27TMH          | 27DC       |
| 31  | 345012-140      | 31DC130       | SRM-29             | DC31DT            | 30XHS          | 31DC       |
| GC12  | 345012-150      | CR-GC150      | ---                | GC12V             | T1275          | GC12       |
| 920   | 345012-155      | CR-155        | ---                | ---               | J150           | EV-145     |
| 921   | 345012-185      | CR-185        | U1850              | 8C12              | J185G          | US-185E    |
|   | 345012-210      | CR-210        | ---                | 9C12              | J185P          | US-185     |

⚠️ **WARNING:** Cancer and reproductive harm - [www.P65Warnings.ca.gov](http://www.P65Warnings.ca.gov)



### VRLA Battery Supplier Cross Reference

| BCI Profile                  | Crown Equipment | Crown Battery | Discover Battery | East Penn Mfg | Fullriver Battery | Interstate Battery | Trojan Battery | US Battery  |
|------------------------------|-----------------|---------------|------------------|---------------|-------------------|--------------------|----------------|-------------|
| <b>6 Volt AGM Batteries</b>  |                 |               |                  |               |                   |                    |                |             |
| GC2                          | 345205-220      | 6CRV220       | EVGC6A-A         | 8AGC2         | DC224-6A          | GC2-HD-AGM         | T105-AGM       | US AGM 2224 |
| 6V-27                        | 356131          | 6CRV215       | EV627A-A         | ---           | DC200-6           | ---                | ---            | US AGM 6V27 |
| <b>12 Volt AGM Batteries</b> |                 |               |                  |               |                   |                    |                |             |
| 18 Ah                        | 345012-018-0S   | 12CE18 (B1)   | D12180-80W       | ES20-12C      | DC20-12           | SLA1116            | ---            | ---         |
| 26 Ah                        | 345012-026-0S   | 12CE26 (B1)   | EV512A-24        | ES26-12       | DC26-12B          | SLA1143            | ---            | ---         |
| U1L                          | 345012-035-0S   | 12CE35        | EVU1A-A          | 8AU1          | DC35-12B          | SLA1155            | ---            | ---         |
| 22NF                         | 345012-055-0S   | 12CE55        | EV22A-A          | 8A22NF        | DC55-12           | SLA1165            | ---            | ---         |
| 24                           | 345012-075-01   | 12CE75 (I)    | EV24A-A          | 8A24          | DC85-12           | SLA1175            | 24-AGM         | ---         |
|                              | 345012-075      | 12CE75 (J)    | ---              | ---           | ---               | ---                | ---            | ---         |
| 27                           | 345012-100-0S   | 12CE100 (J)   | ---              | 8A27          | DC105-12          | ---                | 27-AGM         | US AGM 27   |
|                              | 345012-100-SS   | 12CE100 (M)   | EV27A-A          | 827M          | ---               | ---                | ---            | ---         |
|                              | 345012-100-OU   | 12CE100 (U)   | EV27A-A          | ---           | ---               | SLA1185            | ---            | ---         |

⚠️ **WARNING:** Cancer and reproductive harm - [www.P65Warnings.ca.gov](http://www.P65Warnings.ca.gov)

## Rescue Jump Packs

### Lead Acid Battery Rescue Jump Packs

| Crown Part Number | Description                   | Peak Amps            | Volt  | Cable Length | Gauge | DC Power Source | Air Compressor/ Air Gauge | LED Battery Status Gauge | Built-In Work Light & Flasher | Illuminated LED Clamps | Other Specs  |
|-------------------|-------------------------------|----------------------|-------|--------------|-------|-----------------|---------------------------|--------------------------|-------------------------------|------------------------|--|
| 300455-091        | Rescue Jump Pack Model iStart |                      |       |              |       | ●               |                           |                          |                               |                        | Personal jump pack, light weight, powerful, jumper cables, 12V DC plug, built-in flashlight and charger.   |
| 300455-090        | Rescue Jump Pack Model 900    | 1000                 | 12    | 27"          | 6     | ●               |                           |                          |                               |                        | Premium 18 amp hour AGM battery, LED battery charging status, built-in charger.  |
| 300455-095        | Rescue Jump Pack Model 950    | 1000                 | 12    | 55"          | 6     | ●               | ●                         | ●                        | ●                             | ●                      | 18 amp hour AGM battery, Multiple air tips, polarity alarm, built-in charger, LED battery charging status.   |
| 300455-180        | Rescue Jump Pack Model 1800   | 4000                 | 12    | 62"          | 2     | ●               |                           | ●                        | ●                             |                        | 2 heavy duty 20 amp hour AGM batteries, safeguard audible signal and light, polarity alarm, internal battery gauge.  |
| 300455-210        | Rescue Jump Pack Model 2100   | 4000-12v<br>1800-24v | 12-24 | 62"          | 2     | ●               |                           |                          | ●                             |                        | 12/24V power, dual 12v 20AH high output, AGM batteries, built-in CEC compliant 1 amp internal charger, digital battery voltage gauge reads internal and external, 12v power outlet, battery charging status, USB power outlet. |
| 300455-092        | Rescue Jump Pack Cart         |                      |       |              |       |                 |                           |                          |                               |                        | Sturdy and lightweight, easy to assemble, fits all Rescue models except 900 & iStart, large 4" rubber wheels, jump packs snaps into place.   |

⚠️ **WARNING:** Cancer and reproductive harm - [www.P65Warnings.ca.gov](http://www.P65Warnings.ca.gov)



300455-090



300455-091



300455-095



300455-180



300455-210



300455-092

# Battery Watering Application Chart

Use the following table to help determine the best system for the application at hand. Not all applications are alike; be sure to put the appropriate product into the correct application to ensure years of cost effective & reliable operation.

| Product                                | Watering Gun  | Float System   | Spider Injector System   |
|--|---|--|--|
| <b>Facility Size</b>                   | 1-5 batteries   | 5-25 batteries                                       | 25 or more batteries   |
| <b>Application</b>                     | Light Duty<br>Small Facility<br>Infrequent Use<br>Golf Course | Medium Duty<br>Low Water Pressure<br>Medium Facility | Heavy Duty<br>Abusive Conditions<br>Rapid Charge<br>Battery Changers |
| <b>Time to Install</b>                 | Not Applicable  | 12 Minutes   | 3 Minutes  |
| <b>Time to Fill an 18-Cell Battery</b> | 20 Minutes  | 2-10 Minutes   | 15 Seconds   |
| <b>Payback/ROI</b>                     | \$  | \$\$   | \$\$\$   |

## V-Force® Battery Watering Float System Kits



V-Force Battery Watering Float Systems make the watering of your industrial batteries faster and safer. You will need two components: a water supply (found throughout the One Source Catalog) and one of the part numbers found below. If you have a Philadelphia Scientific Water Supply, you can order a V-Force Float System (e.g. 300220-012-INJ) to replace your existing Stealth Kit or an Injector Kit.

The process is simple. First, identify the manufacturer of your water supply (e.g. Philadelphia Scientific, Battery Filling Systems (BFS), Battery Watering Technologies (BWT), V-Force, or Flow Rite). Then, identify the battery manufacturer; Douglas batteries will require a DIN adapter, which is included. Next, determine the battery voltage (24V, 36V, 48V). The final step is to select the watering system from the table below. The adapters shown are included so you can connect the kit you choose to your water supply.

| If you have a Philadelphia Scientific Stealth/Flow Rite/Crown V-Force water supply:<br>Select a float watering system below |                  |   |   | If you have a Philadelphia Scientific Injector water supply:<br>Select a float watering system below |                  |   |   |
|---|------------------|---|---|--|------------------|---|---|
| Voltage   | Standard Battery | Douglas Battery<br>*Includes DIN Adapters | GNB/Crown Battery<br>*Slim Valve Design | Voltage  | Standard Battery | Douglas Battery<br>*Includes DIN Adapters | GNB/Crown Battery<br>*Slim Valve Design |
| 24V   | 300220-012       | 300221-012                                | 300222-012                              | 24V  | 300220-012-INJ   | 300221-012-INJ                            | 300222-012-INJ                          |
| 36V   | 300220-018       | 300221-018                                | 300222-018                              | 36V  | 300220-018-INJ   | 300221-018-INJ                            | 300222-018-INJ                          |
| 48V   | 300220-024       | 300221-024                                | 300222-024                              | 48V  | 300220-024-INJ   | 300221-024-INJ                            | 300222-024-INJ                          |

| If you have a Battery Filling System water supply:<br>Select a float watering system below |                  |   |   | If you have a Battery Watering Technologies water supply:<br>Select a float watering system below |                  |   |   |
|--|------------------|---|---|---|------------------|---|---|
| Voltage  | Standard Battery | Douglas Battery<br>*Includes DIN Adapters | GNB/Crown Battery<br>*Slim Valve Design | Voltage   | Standard Battery | Douglas Battery<br>*Includes DIN Adapters | GNB/Crown Battery<br>*Slim Valve Design |
| 24V  | 300220-012-BFS   | 300221-012-BFS                            | 300222-012-BFS                          | 24V   | 300220-012-BWT   | 300221-012-BWT                            | 300222-012-BWT                          |
| 36V  | 300220-018-BFS   | 300221-018-BFS                            | 300222-018-BFS                          | 36V   | 300220-018-BWT   | 300221-018-BWT                            | 300222-018-BWT                          |
| 48V  | 300220-024-BFS   | 300221-024-BFS                            | 300222-024-BFS                          | 48V   | 300220-024-BWT   | 300221-024-BWT                            | 300222-024-BWT                          |

**NOTE:** The slim valve should only be used with Crown Battery's Max-Haul and GNB Industrial Power flat-plate batteries. This valve works with all V-Force water supplies.

**NOTE:** Tubing cutter P.N. 300227-007 and collar installation tool P.N. 300310-022 are required for installation of V-Force Float Watering Systems.

**NOTE:** V-Force watering kits installed from the factory on V-Force lead-acid batteries (Part # end with -INS or -INP) use the same components as the kits above.

### V-Force Battery Watering Float System Components

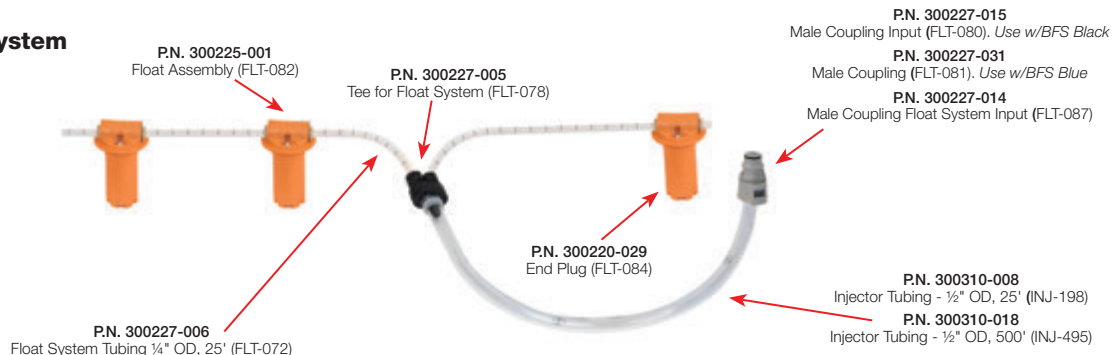

# V-Force® Battery Watering Float Component



300225-001



P.N. 300225-003

**Highly Visible Fill Level Indicator**  
Viewable from top and side

**Push-fit Tubing Ports**  
• Secure tubing by simply pushing tubing into ports  
• No barbed fittings to break

**Snap-Fit Base**  
No separate adapter required

**One Size Fits All Design**  
• Fills all cells to appropriate level  
• Multiple float sizes not needed



**Lowest Profile**  
0.60" (15.2 mm)

**Rotatable Base**  
Once installed

**Built in Float Guard**

The 300225-003 V-Force Slim Valve is specifically designed to fit in the narrow spacing between the straps of a Crown Battery Max-Haul or a GNB Flat-Plate battery.

## Float System - Fill Options

Continued ▶

### Float System Water Supply Options

|            |                             |
|------------|-----------------------------|
| 300222     | Direct Fill Link            |
| 300223     | 5 Gallon Gravity Flow Tank  |
| 300224-090 | 12v 10 Gallon Watering Cart |



### 12v AC 10 Gallon Watering Cart

| Part Number | Vendor Number |
|-------------|---------------|
| 300224-147  | CRT-147       |

### 12v DC 10 Gallon Watering Cart

| Part Number | Vendor Number |
|-------------|---------------|
| 300224-090  | FLT-090       |

- Easy to transport to remote locations
- Easy to fill; large opening
- Charge the battery operated unit from any 120 VAC outlet with the provided charger
- Sturdy 10-gallon polypropylene tank
- 9 ft hose
- On/off switch on rear of unit
- Easy to use; instructions printed on the unit

▲ **WARNING:** Cancer - [www.P65Warnings.ca.gov](http://www.P65Warnings.ca.gov)

#### Replacement parts:

- Battery - P.N. 300224-010-01 (CRT-095)
- Charger, 120VAC to 12VDC - P.N. 300224-149 (CRT-149)
- Pump, 12VDC w/Clamps & Elbows - P.N. 300224-011 (CRT-040)
- Female Float Valve Coupling - Use with BFS Blue - P.N. 300227-030 (BWT-09FBLU1)
- Direct Link Front End Only - P.N. 300227-026 (FLT-070)
- Front End - P.N. 300227-021 (FLT-071)
- Front End for V-Force Water Supply, Small BWT CPC Female Coupling & Flow Indicator - P.N. 300224-013 (FLT-071E)
- Front End for V-Force Water Supply, Large BWT Female Coupling & Flow Indicator - P.N. 300224-014 (FLT-071A)
- Repair Kit, includes black panel, on/off switch, charger jack, screws, does not include wiring - P.N. 300233 (ACC-066)
- Hose - P.N. 300310-008 (INJ-198)
- Cap - P.N. 300224-674 (INJ-674)
- Pump (for AC Cart Only) - P.N. 300224-015 (CRT-148)
- Output hose with QC fitting 12' - P.N. 300224-070 (CRT-070)
- Replacement Wheels, Caps and Axel Kit P.N. 300313 (ACC-104)



### V-Force Demo Watering Kit

| Part Number | Vendor Number |
|-------------|---------------|
| 300220-KIT  | FLT-DD2V      |

- Portable unit designed to demonstrate the V-Force watering system
- Kit Includes: V-Force Watering Demo Unit w/AC power cord and carrying case

### Direct Fill Link

| Part Number | Vendor Number |
|-------------|---------------|
| 300222      | FLT-DL        |



- Designed to attach to in-house plumbing. Water pressure may not exceed 80 PSI. Do not fill from a faucet.

#### Replacement parts:

- Hose 6.1m (20 ft) - P.N. 300222-020 (FLT-039)
- Direct Link Front End Only - P.N. 300227-026 (FLT-070)
- Front End P.N. 300227-021 (FLT-071)
- Female Float Valve Coupling - Use with BFS Blue - P.N. --- (BWT-09FBLU1)
- Female Float Valve Coupling - Use with BFS Black - P.N. 300227-70A (FLT-070A)

### 5 Gallon Gravity Flow Tank-Hose

| Part Number | Vendor Number |
|-------------|---------------|
| 300223      | FLT-GT        |



- Sturdy 5-gallon polypropylene tank
- Easy to fill
- Flow indicator
- 25 ft. hose attaches with a rugged connector
- Note: Unit needs to be mounted at least 5 feet above the top of the battery.

#### Replacement parts:

- Injector Tubing - P.N. 300310-008 (INJ-198)
- Direct Link Front End Only - P.N. 300227-026 (FLT-070)
- Front End - P.N. 300227-021 (FLT-071)
- Female Float Valve Coupling - Use with BFS Blue - P.N. 300227-030 (BWT-09FBLU1)
- Female Float Valve Coupling - Use with BFS Black - P.N. 300227-70A (FLT-070A)
- Shelf - 300223-002 (FLT-018)

### Shelf For Float System Gravity Tank

| Part Number | Vendor Number |
|-------------|---------------|
| 300223-002  | FLT-018       |



- Wall-mountable shelf to hold 5-gallon gravity tank shown above
- 100 lb capacity

▲ **Note:** The use of deionized water is recommended for all tanks.



## Float System - Fill Options



### V-Force Water Deionizer\*

Part Number Vendor Number

300226-005 | PS-300

- Comes with everything you need to make pure water from the tap
- Operates at full-line pressure to dispense pure water directly from the deionizer
- Quick cartridge replacement requires no tools
- 20-ft output hose allows maximum watering flexibility and convenience
- Optional Watering Gun lets you fill a battery directly from the deionizer
- Optional Direct Fill Link to convert from float injector system
- Max operating pressure: 80 PSI

### Replacement parts:

Deionizer Filter - P.N. 300226-006 (PS-600)

Deionizer Hose Output, 20 ft - P.N. 300231-001 (PS-150)

D/C Purity Light with Tee - P.N. 300226-002 (PS-191)

Deionizer Input Hose - P.N. 300226-003 (PS-140)

Quick Connect Set, includes male quick connect x female hose thread, female quick connect x female hose thread and check valve - P.N. 300227-023 (PS-122)

Adapter to convert from float system to injector system - P.N. 300227-026 (FLT-070)

Flow Restrictor, 0.5 GPM, for Deionizers - P.N. 300226-004 (PS-190)

\*Note: Cartridge is 0.61 m (2 ft) long and rated for 2271.25 L (600 gal) of pure water; actual output may vary with tap water quality.



300226-006

300231-001

300226-002

300226-003

300227-023

300227-026

300226-004

WARNING: Cancer - [www.P65Warnings.ca.gov](http://www.P65Warnings.ca.gov)

### Water Quality Tester

Part Number - 300226-009



Check the water quality in total Parts Per Million of Total Dissolved Solids in a facility's water supply. Scan a QR Code to get a battery water quality report emailed to you showing if the water requires a deionizer and how many gallons a cartridge should filter.

WARNING: Cancer - [www.P65Warnings.ca.gov](http://www.P65Warnings.ca.gov)

## Watering Gun

### V-Force® Battery Watering Gun

Part No. Vendor No. Description

300236 GUN-XV Works in 5/8" and 7/8" nozzle applications. Replaces GUN-B, GUN-FB, GUN-C, GUN-FC, GUN-G, GUN-FG, GUN-K, GUN-FK, GUN-R, GUN-R24, GUN-X.

Note: Replacement nozzle not available; order gun.

WARNING: Cancer - [www.P65Warnings.ca.gov](http://www.P65Warnings.ca.gov)

#### Ergonomically Designed

- Easy-squeeze, rugged handle
- 45° bend nozzle
- Less bending over to fill battery

#### Superior Strength

- Built from rugged, engineered ABS plastic
- Weak points eliminated; pressure regulator incorporated into nozzle

#### Replacement part:

Coupling Quick Connect Set - P.N. 300236-095 (ACC-095)



#### Flow Diffuser

- Converts the rapid flow to a gentle spray
- Protects nozzle from damage

#### Secure Level Control

- Will not move over time
- Adjustable or removable
- Pre-set for optimum level for most motive power batteries
- Beveled to conform to vent well at many angles

5-YEAR WARRANTY

#### Faster Fill

- 1.7 GPM
- Spend less time watering



### Pressure Tank Watering Cart

Part Number

300234-003 (CRT-T10G)

- Sturdy 10 gallon (38.9 liter) steel tank
- Capacity gauge indicates how full the tank is
- No battery or electricity required — uses your building's water pressure to deliver water wherever you need it
- 9 ft. (2.7 m) of industrial input hose; 10 ft. (3 m) of industrial output hose

#### Replacement Parts:

Tee, 3/4", w/Regulator - P.N. 300306-003 (INJ-618)

Wheel Kit for Carts - P.N. 300306-004 (INJ-709)

Pressure Tester, 100 PSI, for testing static pressure - P.N. 300234-004 (INJ-PG)



### Output House with Quick-Connect

Part Number

300234-002

- 10 ft. (3 m) of industrial output hose with quick-connect (CRT-120)

## Float System - Parts

### Float System Supplies

| Part No.    | Vendor No.  | Description   | Part No.  | Vendor No.  | Description   |
|-------------|-------------|---|---|-------------|---|
| 300220-029  | FLT-029     | End Plug, Float Systems   | 300227-041  | 09FBLUT3    | BWT Threaded Female Connector   |
| 300220-032  |             | Valve3 w/Adapter Millenium  | 300227-042  | ACC-108     | Gripper Replacement - V-Force Watering System (50/pack)   |
| 300220-083  | FLT-083     | Float Input Assembly w/Filter (1)   | 300227-047  | BWT-09FBLU6 | BWT - 1/4 in. Female Connector (8)  |
| 300220-089  | FLT-089     | Input Assembly for V-Force Watering System w/BFS/BWT Input Coupling & 2 End Plugs | 300227-70A  | FLT-070A    | Replacement Front End – Adapter for Stealth Watering Systems to Injector Water Supplies   |
| 300224-011  | CRT-040     | Pump, 12VDC, with clamps and elbows (7)   | 300227-70E  | FLT-070E    | Adapter with regulator, Injector Water Supply or Deionizer to BFS/BWT Male CPC Coupling   |
| 300225-001  | FLT-082     | Float Assembly - Orange, V-Force  | 300227-072  | 09FRTL72    | Replacement Front End - BWT   |
| 300225-003  | FLT-091     | V-Force Slim Valve  | 300227-073  | DF72F       | Direct Link w/Conn 9FUM1/9FRTL2F  |
| 300227-001  | FLT-L1      | Float Assembly - Black  | 300227-074  | DF72        | Direct Fill Link DF72   |
| 300227-003  | FLT-004U    | Universal Float Input Assembly with Filter, BFS, BWT, Flow Rite, Stealth (2)      | 300227-075  | L70654      | Female Quick Connect For DF72   |
| 300227-006  | FLT-072     | 1/4" Tubing, 25 ft, Float System  | 300227-076  | L70655      | Quick Connect Male Adapter  |
| 300227-010  | FLT-079     | Replacement Input Filter Tee  | 300227-077  | PRG915      | 10 PSI Pressure Regulator   |
| 300227-011  | FLT-035     | Float Valve, Coupling, Female   | 300227-078  | GHAN2       | Handle For Direct Fill Link   |
| 300227-014  | FLT-087     | Twist-Lock Male Input Coupling  | 300227-079  | 09FWM72A    | Flow Indicator  |
| 300227-015* | FLT-080     | Input Coupling Male - BFS Converter - Black (4)                                   | 300227-080  | DF72G       | BWT - Direct Fill Link, Gray Standard   |
| 300227-016  | FLT-085     | DIN Vent Adapter for Douglas Battery  | 300224-149  | CRT-149     | Charger, 120VAC to 12VDC  |
| 300227-021  | FLT-071     | Replacement front end for use with V-Force float systems                          | 300233  | ACC-066     | Repair Kit for 300224-090. Black back panel includes on/off switch, charger jack, and 6 mounting screws. Does not include wiring. (6) |
| 300227-026  | FLT-070     | Direct Link Front End Only; Use with Injector or Deionizer Systems (3)            | 300310-008  | INJ-198     | Injector Tubing 25 feet, 1/2" OD  |
| 300227-030  | BWT-09FBLU1 | Female Coupling - BFS Converter - Blue Connector (5)                              | 300310-018  | INJ-495     | Tubing Type 2, 500 feet, 1/2" OD  |
| 300227-031  | FLT-081     | Male Coupling - BFS system - Blue Connector (5)                                   | 300310-038  | INJ-645     | Inline Regulator Assembly   |
| 300227-037  | 09MBLU1     | BWT 1/4" Male Coupler mates with (8)  | <b>*Note:</b> Order this coupling if you already have BFS fill guns or links. |             |   |
| 300227-038  | 09FWM1      | Spinner/Flow Indicator  | <b>Tools</b>  |             |   |
| 300227-039  | BA-032      | Back Flow Preventer   | 300227-007  | FLT-093     | Tubing Cutter   |
| 300227-040  | BA-031      | Hose Bibb Pressure Reducer  |   |             |   |

⚠ **WARNING:** Cancer - [www.P65Warnings.ca.gov](http://www.P65Warnings.ca.gov)

**Key:** (1) Includes 300227-005 (Tee for Float System), 300227-010 (Assembled Filter), 300310-008 (Injector Tubing 7.62 m [25 ft], 12.7 mm [0.5 in] OD), and 300227-014 (Twist-Lock Male Input Coupling). (2) Includes 300227-005 (Tee for Float System), 300227-010 (Assembled Filter), 300310-008 (Injector Tubing 7.62 m [25 ft], 12.7 mm [0.5 in] OD), and 300227-015 (Input Male Coupling); 300227-014 (Twist-Lock Male Input Coupling), 300227-031 (Male Coupling – BFS system – Blue Connector). (3) Use with Flow Rite. (4) Use with BFS -Black CPC Connector; order if you already have BFS Fill Guns or Links; connects with 1/2" tubing input end of V-Force Watering Kit. (5) Use with BFS - Blue CPC Connector. (6) Includes Black Panel, On/Off Switch, Charger Jack, and six Mounting Screws; does not include wiring. (7) 1.8 gpm and output pressure of 60 psi. (8) 300227-037 mates with BWT 300227-047.



# Float System - Kits & Parts

## Flow Rite - Float Kits

### Millennium Evo — Single-Point Watering System

- Valves work independently of water pressure, allowing a variety of water supply options
- 5-year warranty
- 3-port swivel tee rotates 360° for easier installation
- Flip top color matches shroud color for easy valve identification
- Built-in optical level indicator provides a quick and easy way to see when individual cells require water
- Raised vents provide more room inside the cell for fluid expansion
- Gasket retention tabs keep the gasket in place for simplified installation
- Protective shroud prevents damage to the displacer

| Part No.        | Vendor No.     | Description                   |
|-----------------|----------------|-------------------------------|
| 300220-024-01   | BK-1CO-201-512 | 24V Universal Watering System |
| 300220-036      | BK-1CO-201-518 | 36V Universal Watering System |
| 300220-048      | BK-1CO-201-524 | 48V Universal Watering System |
| 300220-080      | BK-1CO-201-540 | 80V Universal Watering System |
| 300220-024-100* | BK-1Y0-200-512 | 24V Universal Watering System |
| 300220-036-100* | BK-1Y0-200-518 | 36V Universal Watering System |
| 300220-048-100* | BK-1Y0-200-524 | 48V Universal Watering System |
| 300220-080-100* | BK-1Y0-200-540 | 80V Universal Watering System |
| 300220-031      | BD-00870       | Millennium Evo DIN Adapter    |

\*Comes with internal and external spark arrestors with standard length design

Note: Spark Arrestor design does not fit Crown Max Haul 110MX or 155MX or GNB batteries

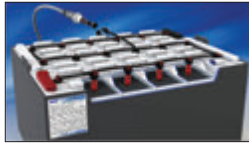

## Flow Rite - Float Kits

### Pro Fill — On-Board Battery Watering System

- Valves work independently of water pressure, allowing a variety of water supply options
- 5-year warranty
- 3-port swivel tee rotates 360° for easier installation
- Patented manifold allows for easier installation
- Winged caps provide fast and secure connection to the battery
- Built-in flame arrestor is a safety feature required for applications where batteries are charged inside the vehicle
- Acid, temperature and impact resistant components
- Protective shroud prevents damage to the displacer

| Part No.   | Vendor No. | Description   |
|------------|------------|---|
| 300220-001 | BG-U24V-1G | 24V Pro-Fill Universal Float Kit w/2.7" spacing         |
| 300220-002 | BG-U24V-2G | 24V Pro-Fill Universal Float Kit w/3.3" spacing         |
| 300220-006 | BG-U24V-4G | 24V Pro-Fill Universal Float Kit w/non standard spacing |
| 300223-024 | BG-U24V-BG | 24V Kit For 8V 2.3"-2.5" Cell Spacing                   |
| 300220-021 | BG-U36V-1G | 36V Kit For 6-6V w/2.7" Space                           |
| 300220-025 | BG-U48V-1G | 48V Kit For (8) 6V Batteries w/2.7" Spacing             |
| 300223-048 | BG-U48V-BG | 48V Kit For 8V 2.3"-2.5" Cell Spacing                   |



## Float System Parts

### Millennium Evo and Pro-Fill

| Part No.      | Vendor No.   | Description  |
|---------------|--------------|--|
| 300220-003    | BA-Y7A-10    | Valve/Float Replacement. Includes Swivel Tee w/O-Ring (300220-016) |
| 300220-004    | BD-T14       | Tubing Replacement - 1 ft.   |
| 300220-008    | BA0QDV-805   | Coupler for Philly Injector  |
| 300220-009    | BA-QDV-505   | Coupler 1/4" Standard fits Millennium Evo, Pro-Fill & Stealth      |
| 300220-015    | BD-00280     | Red End Cap for Swivel Tee   |
| 300220-016    | BA-142       | Swivel Tee w/O-Ring  |
| 300220-022    | BA-QDV-500   | Quick Coupler  |
| 300220-023    | BA-C10-21-6P | Black Flip Top Hydrometer Port Valve (6 per pack)                  |
| 300220-023-01 | BA-C10-31-6P | 2.5" Flip Top Hydrometer Port Valve (6 per pack)                   |
| 300220-030    | BA-T04       | 5' Millennium Evo Braided Hose                                     |



300220-003



300220-004



300220-008



300220-009



300220-015



300220-016



300220-022



300220-023



300220-030

## Float System - Fill Options

| Part No.   | Vendor No. | Description                |
|------------|------------|----------------------------|
| 300220-110 | BA-MS-110  | 20 Gal AC/DC Watering Cart |



## Water Supply - Parts

| Part No.      | Vendor No.   | Description  |
|---------------|--------------|--|
| 300220-005    | BA-MS-320-20 | Regulated Hose Supply with 20' Hose                |
| 300220-010    | BA-QDV-231   | Female Coupler                                     |
| 300220-011    | BA-FLW-80    | Flow Indicator (Current) 3/4" NPT x Female Coupler |
| 300220-013    | BA-FLW-60    | Flow Indicator (Current) 3/4" NPT x 3/8" FNPT      |
| 300220-017-01 | BA-MS-320-00 | Millennium Hose End Assembly                       |
| 300220-019    | BA-019       | Inline Strainer for .5" ID                         |
| 300220-020    | BA-003       | Regulator for Supply Hose                          |
| 300220-026    | BA-051       | Purger for Supply Hose                             |
| 300220-110-01 | BD-00304     | Watering Cart Rear Wheel                           |
| 300220-110-02 | BA-MS-110    | Replacement Watering Cart 20 Gal AC/DC Charge Cord |



300220-005



300220-017-01



300220-010



300220-011



300220-013



300220-110-01



300220-019



300220-020



300220-026

## Spider Injector System – Kits



### Spider Injector System

| Part Number | Vendor Number | Description                            |
|-------------|---------------|--|
| 300302-012  | INJ-LP12      | 24V Spider Injector Kit Standard       |
| 300302-018  | INJ-LP18      | 36V Spider Injector Kit Standard       |
| 300302-024  | INJ-LP24      | 48V Spider Injector Kit Standard       |
| 300309-012  | INJ-LP12D     | 24V Spider Injector Kit w/DIN adapter* |
| 300309-018  | INJ-LP18D     | 36V Spider Injector Kit w/DIN adapter* |
| 300309-024  | INJ-LP24D     | 48V Spider Injector Kit w/DIN adapter* |

\* Use on Douglas Batteries

Note: Tubing cutter 300227-007 and collar installation tool #300310-022 are required for installation of the spider injector watering system.

Note: Prestrung options available upon request.

**ATTENTION:** Spider Injector Watering Systems require a minimum of 25 psi and maximum of 35 psi flowing water at a rate of 8 gallons per minute. If the flow is inadequate, the Injectors will not shut off. If a factory authorized water supply is not being used water pressure from the wall must be confirmed with a 300310-027 Water Flow Pressure Measurement Tool.



### Features

- **Very Fast Operation:** An average industrial truck battery can be filled, with precise level control, in less than 15 seconds. The savings in labor costs alone often pays for the system within its first year of operation.
- **Quality of Watering:** It extends the life of each expensive battery it is installed on due to improved quality of watering. The battery is properly watered every time.
- **Safety and Environmental Cleanliness:** There is no need to peer into cells to inspect levels as with manual filling. Spider Injector Watering Systems automatically fill each cell to the correct level, so no overfilling and no electrolyte overflow during charge.
- **Compact:** A very low profile allows them to fit on almost any battery. Spider Injectors can **snap in and out** to allow inspection of electrolyte levels and specific gravities.
- **Rugged:** Tough enough to survive impacts, abuse and extremes of battery temperatures. There are no exposed parts to break off even when a Spider Injector is removed from a cell. True level sensing mechanism. Needs no submergence to sense level as a float does. Can work right down to the top of the separators. Will not fail if it touches cell components.
- **No-Freeze Tubing:** The surplus water drains from the tubing into cells after filling is complete. This allows the system to be used in cold stores and other freezing environments.
- **2-Stage Filtration:** In addition to the filter screen in the water tubing, each Spider Injector has its own individual filter.
- **Easy Installation:** Features flexible push tubing.
- **5-Year Warranty:** Warrantable against defects in materials and workmanship.

### Spider Injector Watering System

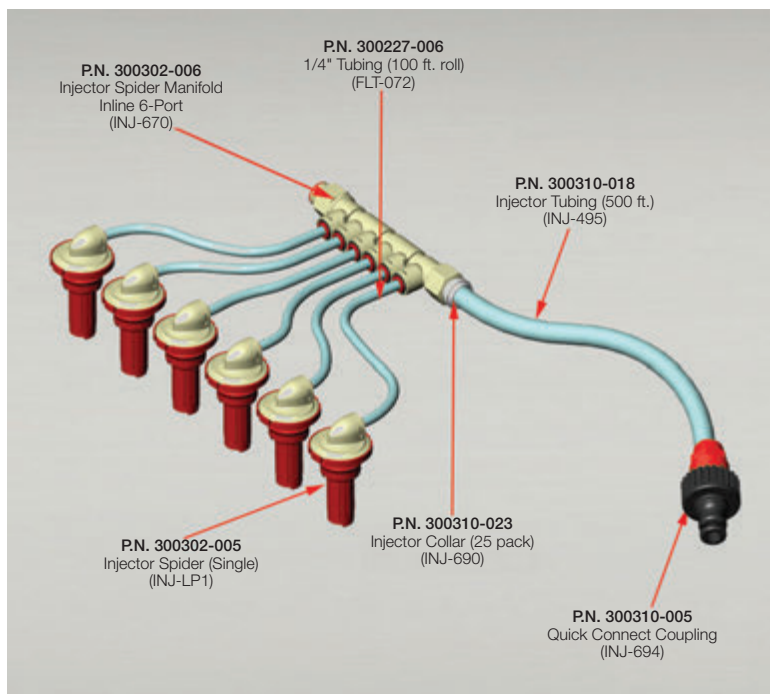

## Injector System - Fill Options



### Bladder Tank 10 Gallon

| Part Number | Vendor Number |
|-------------|---------------|
| 300306      | INJ-T10M      |

- 10 gallon steel tank
- Requires no power

#### Tank capacities based on input pressure

| Input Pressure | Tank Capacity |
|----------------|---------------|
| 80 PSI         | 10 Gallon     |
| 70 PSI         | 9.5 Gallon    |
| 60 PSI         | 8 Gallon      |
| 50 PSI         | 6 Gallon      |

**Note:** Water pressure below 50 PSI will require a booster pump.

#### Replacement parts:

Instant Valve Pro - P.N. 300310-033 (INJ-607)  
 Female Quick Disconnect - P.N. 300227-029 (INJ-688)  
 Intake Hose, Black - P.N. 300306-001 (ACC-065)  
 Gauge Assm Kit - P.N. 300310-040 (ACC-036)  
 Red Hose - P.N. 300306-002 (INJ-070)  
 Tee, 3/4", w/Regulator - P.N. 300306-003 (INJ-618)  
 Wheel Kit For Carts - P.N. 300306-004 (INJ-709)



### Hydro Cart Injector

| Part Number | Vendor Number |
|-------------|---------------|
| 300302      | INJ-HCT       |

- Sturdy 20 gallon polypropylene tank
- 30 ft of total reach, 15-ft power cord plus 15 ft of 5/8" high-output industrial hose
- Handles like a hand truck
- On/off switch and power indicator located on front of unit
- Plug into 110 VAC outlet
- Flow indicator tells when the injectors have shut off

#### Replacement parts:

Pump - P.N. 300311 (INJ-540)  
 Inline Regulator Assm - P.N. 300310-038 (INJ-645)  
 Instant Valve Pro - P.N. 300310-033 (INJ-607)  
 Black Handle Assm., includes wheels, bearings & axle - P.N. 300312 (Q-0239)  
 Parts Kit, includes hoses & fittings to connect to the submersible pump for charger mounted water supplies - P.N. 300310-037 (INJ-657)  
 Gray Switch - P.N. 300302-001 (INJ-672)  
 Red Hose - P.N. 300306-002 (INJ-070)  
 Heavy Duty Red Output Hose w/Kink Protector and Brass Fittings - P.N. 300302-002 (INJ-676)  
 Retractable Cord Reel - P.N. 300302-003 (INJ-711)  
 Wheel Kit For Carts - P.N. 300306-004 (INJ-709)



### Mini Hydro Cart Injector

| Part Number | Vendor Number |
|-------------|---------------|
| 300303      | INJ-MINI      |

- 10 gallon polypropylene tank
- 23 ft of total reach
- Easy to transport to remote locations
- Plug into 110 VAC outlet

#### Replacement parts:

Pump - P.N. 300311 (INJ-540)  
 Instant Valve Pro - P.N. 300310-033 (INJ-607)  
 Output Hose - P.N. 300303-001 (INJ-623)  
 Wheels, Caps & Axle Kit - P.N. 300313 (ACC-104)  
 On/Off Switch - P.N. 300314



### Booster Pump

| Part Number | Vendor Number |
|-------------|---------------|
| 300304      | INJ-BP        |

- Use with 300306 bladder tank
- Delivers 1.5 Gallons per minute
- Automatically turns off when output pressure reaches 80 psi
- Wall mountable and requires 110v A/C outlet
- 15 ft input hose

Used when the in-plant water pressure is not high enough to completely fill a bladder tank. It cannot be used to fill the injector system directly since it does not have a high enough flow rate.

#### Replacement parts:

Quick Connect Set, includes male quick connect x female hose thread, female quick connect x female hose thread, & check valve - P.N. 300227-023 (ACC-094)  
 Pump, 115 VAC, for INJ-BP, includes clamps & elbows - P.N. 300304-001 (INJ-048)



### Direct Fill Hose Injector

| Part Number | Vendor Number | Length |
|-------------|---------------|--------|
| 300305      | INJ-DF        | 18 ft. |

























**Note:** The Direct Fill Hose Injector requires a minimum of 25 psi of flowing water at a rate of 8 gallons per minute. If the flow is inadequate, the Injectors will not shut off. If a factory authorized water supply is not being used, water pressure from the wall must be confirmed with a 300310-027 Water Flow Pressure Measurement Tool.

#### Replacement parts:

Instant Valve Pro - P.N. 300310-033 (INJ-607)  
 Pressure Regulator - P.N. 300310-039 (INJ-435)

▲ **Note:** The use of deionized water is recommended for all tanks.

## Injector System - Parts

|   |   |   |  |   |  |
|---|---|---|--|---|--|
| <br>300227-029                   | <br>300302-005                   | <br>300302-006 | <br>300310-005  | <br>300310-008                 | <br>300310-010                  |
| <br>300310-012                   | <br>300310-013                   | <br>300310-015 | <br>300310-016 | <br>300310-017                 | <br>300310-018                  |
| <br>300310-019                   | <br>300310-023                   | <br>300310-025 | <br>300310-026  | <br>300310-028                 | <br>300310-033                  |
| <br>300310-034                   | <br>300310-037                   | <br>300310-038 | <br>300310-039  | <b>Tools</b><br><br>300310-009 | <b>Tools</b><br><br>300310-014 |
| <b>Tools</b><br><br>300310-022 | <b>Tools</b><br><br>300310-027 |   |  |   |  |

### Injector System Supplies

| Part Number | Vendor Number | Description                                      |
|-------------|---------------|--|
| 300227-029  | INJ-688       | Female Quick Disconnect                          |
| 300302-005  | INJ-LP1       | Water Injector Spider, Single                    |
| 300302-006  | INJ-670       | Injector Spider Manifold 6-Port                  |
| 300310-005  | INJ-694       | Input Coupling Quick Connect for Water Injectors |
| 300310-008  | INJ-198       | Injector Tubing 25 feet, 1/2" OD                 |
| 300310-010  | INJ-686       | Ratchet Clamp (1)                                |
| 300310-012  | INJ-693       | Vent Adapter Quarter Turn                        |
| 300310-013  | INJ-706       | Vent Adapter DIN                                 |
| 300310-015  | INJ-TL1       | Terminating Water Injector                       |
| 300310-016  | INJ-687       | Repair Coupling with Collars                     |
| 300310-017  | INJ-692       | Check Valve (2)                                  |
| 300310-018  | INJ-495       | Injector Tubing Type (2) 500 feet, 1/2" OD       |
| 300310-019  | INJ-L1A       | Water Injector Extended Downtube                 |
| 300310-023  | INJ-690       | Water Injector Collar                            |
| 300310-025  | INJ-691       | Wye Fitting with Collars (3)                     |
| 300310-026  | INJ-695       | ClampLock Injector (single) with collars (4)     |

| Part Number | Vendor Number | Description   |
|-------------|---------------|---|
| 300310-028  | INJ-697       | Injector Standard   |
| 300310-033  | INJ-607       | Instant Valve Pro (5)   |
| 300310-034  | ACC-091       | Check Valve/Quick Disconnect Coupling Male  |
| 300310-037  | INJ-657       | Replacement Parts Kit - hoses and fittings to connect the hydrotronic to submersible pump (6) |
| 300310-038  | INJ-645       | Inline Regulator Assembly   |
| 300310-039  | INJ-435       | Pressure Regulator  |
| 300310-040  | ACC-036       | Gauge Assembly Kit for 10 gal. Bladder Tanks  |

### Tools

| Part Number | Vendor Number | Description                          |
|-------------|---------------|--------------------------------------|
| 300310-009  | INJ-685       | Installation Tape 36 yards           |
| 300310-014  | INJ-311       | Punch Tool Tubing                    |
| 300310-022  | INJ-601       | Collar Installation Tool             |
| 300310-027  | INJ-FC        | Water Flow Pressure Measurement Tool |

### Key:

- (1) Used on Terminating End of Injector Kit; also used with Wye Fitting to lock the Hose
- (2) Quick disconnect on End of Injector System that will plug into water supply
- (3) Connects the Fill Hose to the Injector System
- (4) This style of injectors push into the cell like the stealths do; need adapter if have Douglas Battery (FLT-085) 300227-016
- (5) Replaces On/Off Valve - INJ-120, Nozzle - INJ-121, and Instant Valve Assembly - INJ-491
- (6) Includes Hoses and Fittings to connect to the Submersible Pump for Charger-Mounted Water Supplies

## Battery Accessories

### V-Force Small Fleet Battery Management System (BMS)

Takes guess work out of choosing next battery. Saves 2 to 5 minutes per battery change. Reduces the number of changes by 10-20%. Increases battery life by 6 months due to longer cool down times and more even battery usage. Longer life means fewer battery purchases. Audible mispicked battery alarm. Manages up to 50 chargers for each battery type. Works with High Frequency, SCR, and Ferro Resonant chargers in conventional battery changing applications. Adjustable to pool battery voltage via internal jumper. Daisy-chained data cable connections for quick non-certified install with standard tools. Required Blue LED next battery Sentinel Light (Part # 300314-SU6) sold separately. Recommended QTY of 1 per charger.

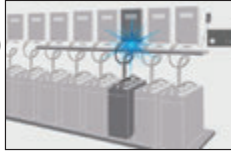

Part Number - 340640

V-Force Basic BMS Controller includes 2, 25 ft. CAT 3 Sentinel data cables and power supply with AC adaptor tips. Recommend QTY 1 for up to 50 chargers of each battery type.



Part Number - 300314-SU6

Sentinel with blue light includes 1, 7 ft. CAT 3 Sentinel data cable and couplers. Recommended QTY 1 per charger.

### Battery Straps

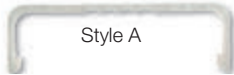

Style A

| Part No.   | Description  | Style |
|------------|--|-------|
| 300040     | Used to lift & move battery P.N. 156131 & 345012-100-SS  | A     |
| 300040-001 | Used to lift & move battery P.N. 345012-075  | A     |
| 300040-003 | For post terminal use only. Double grip jaws automatically lock. Non-conductive plastic strap is acid resistant. | B     |
| 300040-004 | For post terminal use only. Double grip jaws automatically lock. Non-conductive plastic strap is acid resistant. | C     |

▲WARNING: Cancer and reproductive harm - [www.P65Warnings.ca.gov](http://www.P65Warnings.ca.gov)



Style B



Style C

### Battery Pogo Stick

| Part No. | Description  |
|----------|--|
| 300038   | Used to keep battery connectors and cables off the floor at charging stations, preventing damage and wear. 39" in length, 1" in diameter. Supports up to 10 ft of 3/0 cable. |

▲Replacement Rubber Grommet P.N. 300038-001



▲WARNING: Cancer and reproductive harm - [www.P65Warnings.ca.gov](http://www.P65Warnings.ca.gov)

### Heavy Duty Battery Pogo Stick

| Part No.   | Description  |
|------------|--|
| 300038-1ZD | Zinc plated 40". Up to 66% stronger than competitive designs. Mounting hardware included. Includes rubber grommet clamp. |

\*Recommended for V-HFM<sup>3</sup> applications.

▲WARNING: Cancer and reproductive harm - [www.P65Warnings.ca.gov](http://www.P65Warnings.ca.gov)



### Tender Kit

| Part No. | Description  |
|----------|--|
| 309820   | Secure large DC battery cables with or without a pogo stick. Superior strength and high performance in the most extreme applications. Heavy-duty clamp design corrosion resistant composite body. 16" Single with Clamp. |



▲WARNING: Cancer and reproductive harm - [www.P65Warnings.ca.gov](http://www.P65Warnings.ca.gov)

### Tool Balance Swivel Mount

| Part No.   | Min.-Max. Load | Reel Weight | Cable Length |
|------------|----------------|-------------|--------------|
| 300038-005 | 3.0-5.0 lbs.   | 1.5 lbs.    | 6'           |

The BD Series Tool Balancer is an economical choice for balancing tools weighing up to 5 lbs. The molded ABS housing has a smooth exterior with rounded edges designed for maximum ergonomic appeal. The tool balancer is easy to adjust and reliable.



### Long L-Bracket

| Part No.   | Description                                 |
|------------|---|
| 396547-002 | Includes hardware. Used to hold pogo stick. |

▲WARNING: Cancer and reproductive harm - [www.P65Warnings.ca.gov](http://www.P65Warnings.ca.gov)

### L-Bracket with Pogo Stick

| Part No.      | Description                     |
|---------------|---------------------------------|
| 396547-BKT    | Includes Standard Pogo Stick.   |
| 396547-BKT-01 | Includes Heavy Duty Pogo Stick. |

▲WARNING: Cancer and reproductive harm - [www.P65Warnings.ca.gov](http://www.P65Warnings.ca.gov)

### L-Bracket

| Part No. | Description   |
|----------|---|
| 300460   | Includes hardware. Used to mount pogo stick to racking. |



### Cable Retractor

| Part No.   | Description   |
|------------|---|
| 300038-002 | Heavy-duty cable retractor holds larger cables and is adjustable and lightweight. The retractor mounts to charger stand, shelf or wall bracket by 2 mounting holes. |

▲WARNING: Cancer and reproductive harm - [www.P65Warnings.ca.gov](http://www.P65Warnings.ca.gov)



### Battery Side-Lift Carrier

| Part No.   | Description  |
|------------|--|
| 300040-002 | Best quality for all battery types and sizes. Adjustable notches securely lock in place. Features bicycle grip handle and sidewall pads. |

▲WARNING: Cancer and reproductive harm - [www.P65Warnings.ca.gov](http://www.P65Warnings.ca.gov)



### Magnet Mount Cable Holder

| Part No. | Description   |
|----------|---|
| 396568   | Conveniently secures battery and charger cables, preventing cable damage and clutter. Mount to any flat, ferrous metallic surface such as a charger stand, charger wall bracket, or charger case. |

▲WARNING: Cancer and reproductive harm - [www.P65Warnings.ca.gov](http://www.P65Warnings.ca.gov)



## Battery Repair Parts

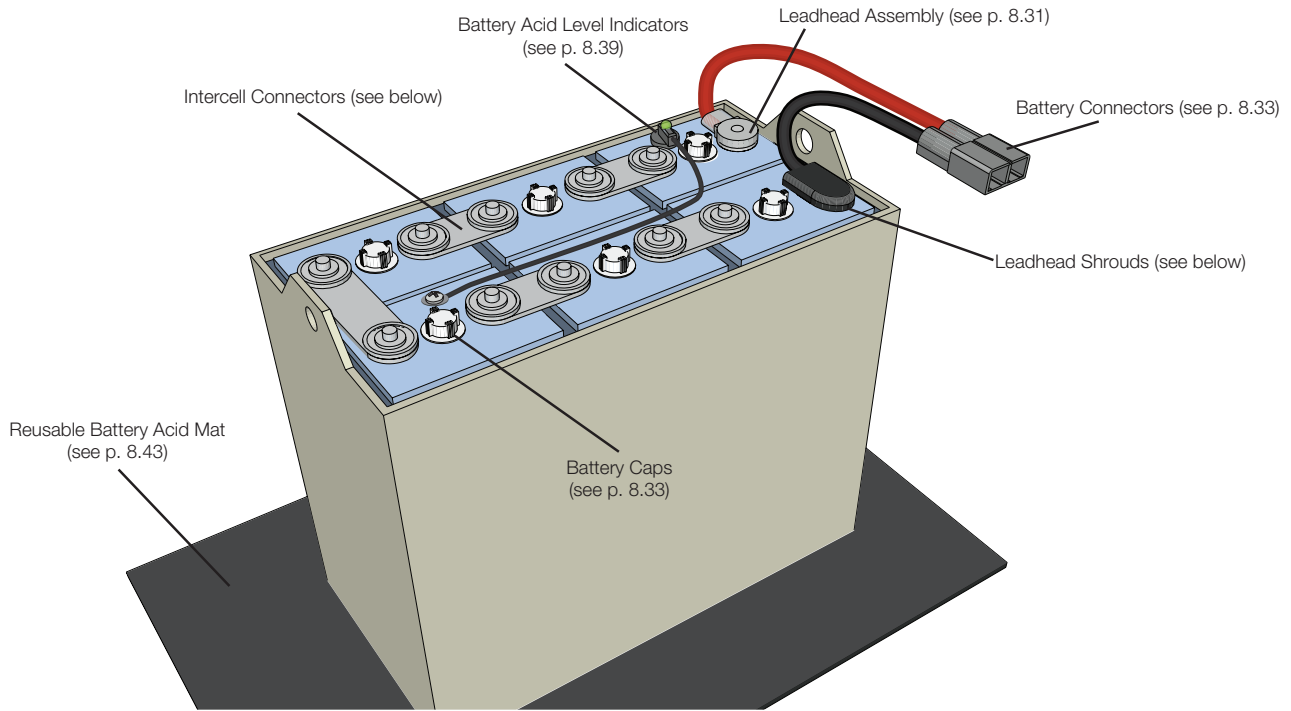

### Leadhead Shrouds

| Part Number                                     | Description |
|---|-------------|
| <b>Straight</b>                                 |             |
| 300430-001                                      | Black       |
| 300431-001                                      | Red         |
| <b>Offset, One Hole</b>                         |             |
| 300426-001                                      | Black/Right |
| 300427-001                                      | Red/Right   |
| 300428-001                                      | Black/Left  |
| 300429-001                                      | Red/Left    |
| <b>Offset Two Hole - 3.00" Center to Center</b> |             |
| 300432-001                                      | Black/Right |
| 300433-001                                      | Red/Right   |
| 300434-001                                      | Black/Left  |
| 300435-001                                      | Red/Left    |
| <b>Offset Two Hole - 3.75" Center to Center</b> |             |
| 300436-001                                      | Black/Right |
| 300437-001                                      | Red/Right   |
| 300438-001                                      | Black/Left  |
| 300439-001                                      | Red/Left    |
| <b>Universal</b>                                |             |
| 300451  | Black       |

**WARNING:** Cancer and reproductive harm - [www.P65Warnings.ca.gov](http://www.P65Warnings.ca.gov)

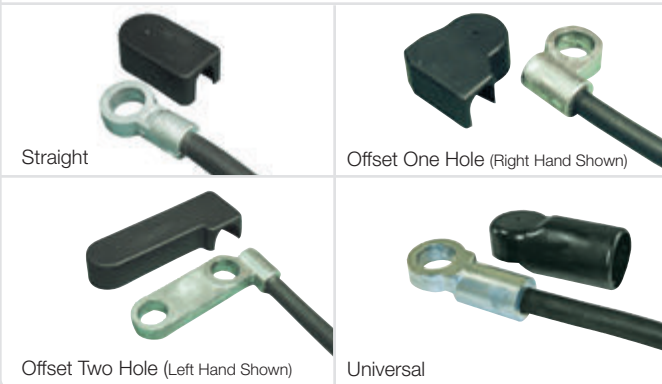

### Fast Charge Leadhead Shrouds



#### Fast-Charge Leadhead Shrouds

| Part Number | Description |
|-------------|-------------|
| 300464-00R  | Red         |
| 300464-00B  | Black       |

■ Fits 2/0, 3/0 & 4/0

### Intercell Connectors/Shrouds

#### V-Force® Intercell Battery Connectors

| Part Number | Description            |
|-------------|------------------------|
| 300402-001  | 3" - 2 hole connector  |
| 300402-007  | 3½" - 2 hole connector |
| 300402-003  | 3½" - 2 hole connector |
| 300402-002  | 3¾" - 2 hole connector |
| 300402-004  | 5" - 2 hole connector  |
| 300402-005  | 5¾" - 2 hole connector |
| 300402-006  | 6" - 2 hole connector  |

Note: length is measured center to center

**WARNING:** Cancer and reproductive harm - [www.P65Warnings.ca.gov](http://www.P65Warnings.ca.gov)

- Safe-burning, high-conductivity lead
- 3% antimonial lead, free of voids and porosity, greater electrical conductivity



#### V-Force® Intercell Shrouds



| Part Number | Size (Center to Center) |
|-------------|-------------------------|
| 300424-001  | 3" - 3⅛"                |
| 300425-001  | 3½"                     |
| 300425-005  | 3¾"                     |
| 300425-004  | 5"                      |
| 300425-007* | 5¼"                     |
| 300425-006* | 6"                      |
| 300425-002  | 10½ - 10¾"              |
| 300425-003  | 12½ - 12¾"              |

\*Are not V-Force branded

**WARNING:** Cancer and reproductive harm - [www.P65Warnings.ca.gov](http://www.P65Warnings.ca.gov)



**Standard Cable Assemblies**

Note: For Enersys Batteries, use Universal Leadhead Assemblies.

| Part Number   | Description     | Style |   |
|---|-----------------|-------|---|
| <b>Straight</b>   |                 |       |   |
| 300400-008  | #2 red cable    | A     |   |
| 300400-007  | #2 black cable  |       |   |
| 300400-001  | #1 red cable    |       |   |
| 300400-002  | #1 black cable  |       |   |
| 300400-009  | 1/0 red cable   |       |   |
| 300400-010  | 1/0 black cable |       |   |
| 300400-022  | 2/0 red cable   |       |   |
| 300400-021  | 2/0 black cable |       |   |
| 300400-027  | 3/0 red cable   |       |   |
| 300400-028  | 3/0 black cable |       |   |
| 300400-031  | 4/0 red cable   |       |   |
| 300400-032  | 4/0 black cable |       |   |
| <b>Offset, 90 degree</b>  |                 |       |   |
| 300400-003  | #2 red cable    |       | B |
| 300400-004  | #2 black cable  |       |   |
| 300400-033  | #1 red cable    |       |   |
| 300400-034  | #1 black cable  |       |   |
| 300400-011  | 1/0 red cable   |       |   |
| 300400-012  | 1/0 black cable |       |   |
| 300400-019  | 2/0 red cable   |       |   |
| 300400-020  | 2/0 black cable |       |   |
| 300400-030  | 3/0 red cable   |       |   |
| 300400-029  | 3/0 black cable |       |   |
| 300400-038  | 4/0 red cable   |       |   |
| 300400-037  | 4/0 black cable |       |   |
| <b>Offset, 90 degree, Two Hole Posts, 3.00" Post Hole Centers</b>   |                 |       |   |
| 300400-013  | 1/0 red cable   | C     |   |
| 300400-014  | 1/0 black cable |       |   |
| 300400-015  | 2/0 red cable   |       |   |
| 300400-016  | 2/0 black cable |       |   |
| 300400-023  | 3/0 red cable   |       |   |
| 300400-024  | 3/0 black cable |       |   |
| 300400-061  | 4/0 red cable   |       |   |
| 300400-062  | 4/0 black cable |       |   |
| <b>Offset, 90 degree, Two Hole Posts, 3.75" Post Hole Centers</b>   |                 |       |   |
| 300400-040  | 1/0 red cable   |       | C |
| 300400-039  | 1/0 black cable |       |   |
| 300400-018  | 2/0 red cable   |       |   |
| 300400-017  | 2/0 black cable |       |   |
| 300400-025  | 3/0 red cable   |       |   |
| 300400-026  | 3/0 black cable |       |   |
| 300400-035  | 4/0 red cable   |       |   |
| 300400-036  | 4/0 black cable |       |   |
| <b>Offset, 90 degree, Three Hole Posts, 3" Post Hole Centers</b>    |                 |       |   |
| 300400-044  | 1/0 red cable   | D     |   |
| 300400-043  | 1/0 black cable |       |   |
| 300400-046  | 2/0 red cable   |       |   |
| 300400-045  | 2/0 black cable |       |   |
| 300400-050  | 3/0 red cable   |       |   |
| 300400-049  | 3/0 black cable |       |   |
| 300400-054  | 4/0 red cable   |       |   |
| 300400-053  | 4/0 black cable |       |   |
| <b>Offset, 90 degree, Three Hole Posts, 3.75" Post Hole Centers</b> |                 |       |   |
| 300400-042  | 1/0 red cable   | D     |   |
| 300400-041  | 1/0 black cable |       |   |
| 300400-048  | 2/0 red cable   |       |   |
| 300400-047  | 2/0 black cable |       |   |
| 300400-052  | 3/0 red cable   |       |   |
| 300400-051  | 3/0 black cable |       |   |
| 300400-056  | 4/0 red cable   |       |   |
| 300400-055  | 4/0 black cable |       |   |

▲WARNING: Cancer and reproductive harm - www.P65Warnings.ca.gov

**Universal Burn-on 5 ft. Leadhead Cable Assemblies**

Note: Designed to be burned onto intercell connectors; use Universal Leadheads on Enersys Batteries.

| Part Number     | Description     | Style |
|-----------------|-----------------|-------|
| <b>Straight</b> |                 |       |
| 300466-001      | 1/0 red cable   | A     |
| 300466-002      | 1/0 black cable |       |
| 300466-003      | 2/0 red cable   |       |
| 300466-004      | 2/0 black cable |       |
| 300466-005      | 3/0 red cable   |       |
| 300466-006      | 3/0 black cable |       |
| 300466-007      | 4/0 red cable   |       |
| 300466-008      | 4/0 black cable |       |

▲WARNING: Cancer and reproductive harm - www.P65Warnings.ca.gov

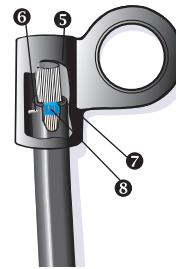
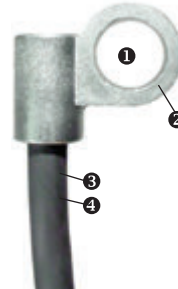

- 1 Post Hole 15/16"
- 2 5% Antimonial Lead for Durability
- 3 EPDM Insulation  
Rated 600 Volt  
Temperature Range: -40 +105°C  
(-40 +221°F), Flame Resistant, Abrasion,  
Tear and Cut Resistant, Impervious to  
Battery Acid, Oil, Grease
- 4 Quickflex Cable, Soft Bare #30 Copper  
Wire, Class K, Rope Stranded for  
Maximum Flexibility, Conforms to  
ICEA/NEMA Welding Cable Requirements,  
Meets or Exceeds ASTMB-172
- 5 Copper Wire Hot Tinned for Maximum Bond  
to Lead
- 6 Anti-pullback Lock Pin
- 7 Cable Deeply Embedded in Lead,  
Preventing Insulation Pull-back
- 8 Internal Silicone Seal™ Silicone Seal Under  
Insulation Prevents Corrosion, Sealing Out  
Acid and Water

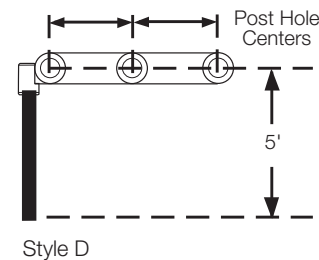
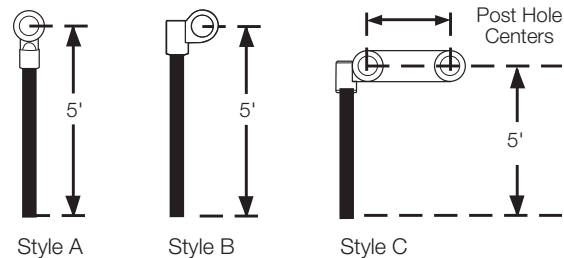

## Leadheads

### Fast Charge Leadheads

| Part Number   | Description     | Style |
|---|-----------------|-------|
| <b>Offset 90 degree</b>   |                 |       |
| 300461-013  | 2/0 red cable   | A     |
| 300461-014  | 2/0 black cable |       |
| 300461-015  | 3/0 red cable   |       |
| 300461-016  | 3/0 black cable |       |
| 300461-017  | 4/0 red cable   |       |
| 300461-018  | 4/0 black cable |       |
| <b>Offset, 90 degree, Two Hole Posts, 3" Post Hole Centers</b>    |                 |       |
| 300461-001  | 2/0 red cable   | B     |
| 300461-002  | 2/0 black cable |       |
| 300461-005  | 3/0 red cable   |       |
| 300461-006  | 3/0 black cable |       |
| 300461-009  | 4/0 red cable   |       |
| 300461-010  | 4/0 black cable |       |
| <b>Offset, 90 degree, Two Hole Posts, 3.75" Post Hole Centers</b> |                 |       |
| 300461-003  | 2/0 red cable   | B     |
| 300461-004  | 2/0 black cable |       |
| 300461-007  | 3/0 red cable   |       |
| 300461-008  | 3/0 black cable |       |
| 300461-011  | 4/0 red cable   |       |
| 300461-012  | 4/0 black cable |       |

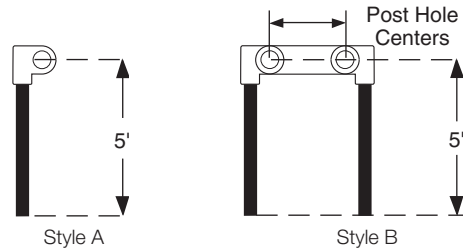
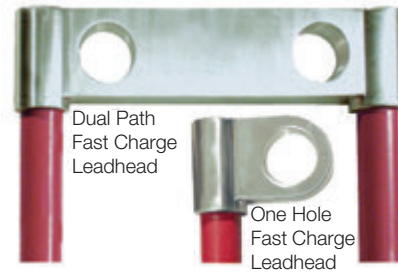

**WARNING:** Cancer and reproductive harm - [www.P65Warnings.ca.gov](http://www.P65Warnings.ca.gov)

### Bolt-on 5 ft. Cable Assemblies

| Part Number | Description                                  |
|-------------|--|
| 300401-001  | #2 red - single cable                        |
| 300401-002  | #2 black - single cable                      |
| 300471-00R  | #2 red - single cable (for Deka batteries)   |
| 300471-00B  | #2 black - single cable (for Deka Batteries) |
| 300401-011  | #1 red - single cable                        |
| 300401-012  | #1 black single cable                        |
| 300401-003  | 1/0 red - single cable                       |
| 300401-004  | 1/0 black - single cable                     |
| 300401-005  | 2/0 red - single cable                       |
| 300401-006  | 2/0 black - single cable                     |
| 300401-007  | 3/0 red - single cable                       |
| 300401-008  | 3/0 black - single cable                     |
| 300401-009  | 4/0 red - single cable                       |
| 300401-010  | 4/0 black- single cable                      |

**Note:** Cone & Fastener not included in assembly; must be ordered separately.

**WARNING:** Cancer and reproductive harm - [www.P65Warnings.ca.gov](http://www.P65Warnings.ca.gov)



Cable Assembly



Standard Cone



Fastener



### Fastener

| Part Number | Description  |
|-------------|--|
| 300419      | Includes 10 of each: bolt, flat washer and lock washer |

### Standard Cones, 5 per package (Fits all gauge sizes)

| Part Number   | Single Piece  | Description     |
|---------------|---------------|-----------------|
| 300416-001-05 | 300416-001-01 | 1 hole          |
| 300416-002-05 | 300416-002-01 | 2 hole - 3"     |
| 300416-003-05 | 300416-003-01 | 2 hole - 3 3/4" |
| 300416-004-05 | 300416-004-01 | 3 hole - 3 3/4" |

**WARNING:** Cancer and reproductive harm - [www.P65Warnings.ca.gov](http://www.P65Warnings.ca.gov)

## Safety Boots/Protective Caps



| Part Number | Amp | SB/SBX |
|-------------|-----|--------|
| 300463-050  | 50  | SB     |
| 300463-175  | 175 | SB     |
| 300463-350  | 350 | SB     |

- Keep terminals clean



| Part Number | Amp | SB/SBX |
|-------------|-----|--------|
| 300413-050  | 50  | SB     |
| 300413-175  | 175 | SB     |
| 300413-350  | 350 | SB     |
| 300462-175  | 175 | SBX    |
| 300462-350  | 350 | SBX    |

- Strain relief for cables
- Seals contacts and cable from corrosion, acid, chemicals, salt, water, and dirt
- Adjustable cable ports cut to fit cable gauge
- Does not interfere with mounting brackets, handles & protective caps
- Made of black vinyl rubber
- Operator safety
- Reduces chances of a short circuit
- Isolates negative from positive
- Ergonomic grip



### Battery Caps

| Part No.   | Type                   | Color  | Ht. (in) |
|------------|------------------------|--------|----------|
| 300053-001 | Screw                  | Yellow |          |
| 300053-003 | Screw                  | Red    |          |
| 300053-004 | Screw                  | White  |          |
| 300053-002 | Flip top w/blue lid    | Yellow | 1.25     |
| 300053-005 | Flip top w/yellow lid  | Yellow | 1.00     |
| 300053-006 | Flip top w/blue lid    | Blue   | 1.00     |
| 300053-008 | Douglas style flip top | Black  | 2.75     |

### Insulator Terminal Protectors



| Part No.   | Color | Fits Gauges | Post Ht. (in) | Type |
|------------|-------|-------------|---------------|------|
| 125958-001 | Red   | 6 & 8       | 0.94          | A    |
| 125958-002 | Black | 6 & 8       | 0.94          | A    |
| 125588-001 | Black | 1/0 & 2/0   | 1.02          | B    |
| 125588-002 | Black | 4 & 6       | 0.85          | C    |
| 125588-003 | Black | 4 & 6       | 0.95          | D    |
| 125588-004 | Black | 10          | 0.75          | E    |
| 125588-005 | Black | 3/0 & 4/0   | 0.95          | B    |
| 125588-006 | Black | 4/0         | 1.60          | B    |
| 125588-007 | Black | 2 & 4       | 0.90          | F    |

Protects against electrical system shorts. Reduces the risk of battery explosion caused by sparks. High temperature PVC construction. Color coded for easy polarity identification.

**WARNING:** Cancer - [www.P65Warnings.ca.gov](http://www.P65Warnings.ca.gov)



## Battery Connectors

Continued ▶



### 50 SB Ampere

| Part Number | Color | Cable Size |
|-------------|-------|------------|
|-------------|-------|------------|

#### Connector Housing

|            |      |    |
|------------|------|----|
| 078723-005 | Gray | NA |
| 340054-001 | Red  | NA |

#### Housing & Contact Kits

|            |      |       |
|------------|------|-------|
| 340054-003 | Red  | 10-12 |
| 077917-005 | Gray | 10-12 |
| 340054-002 | Red  | 6     |

#### Contacts

|            |    |       |
|------------|----|-------|
| 078724-003 | NA | 10-12 |
| 078724-005 | NA | 6     |

#### Accessories

| Part Number | Description |
|-------------|-------------|
|-------------|-------------|

#### Battery Connecting Handle

|        |                         |
|--------|-------------------------|
| 120573 | Red - Includes hardware |
|--------|-------------------------|

#### Cable Clamp

|            |   |
|------------|---|
| 340056-001 | Cannot be used in combination with handle |
|------------|---|

#### Dust Cap

|        |     |
|--------|-----|
| 155450 | Red |
|--------|-----|

340056-001

155450



### 120 Ampere

| Part Number | Color | Cable Size |
|-------------|-------|------------|
|-------------|-------|------------|

#### Connector Housing

|        |      |    |
|--------|------|----|
| 081591 | Blue | NA |
|--------|------|----|

#### Contacts

|        |    |     |
|--------|----|-----|
| 081823 | NA | 2/0 |
|--------|----|-----|



### 180 Ampere

| Part Number | Color | Cable Size |
|-------------|-------|------------|
|-------------|-------|------------|

#### Connector Housing

|        |      |    |
|--------|------|----|
| 084528 | Blue | NA |
|--------|------|----|

#### Kit Housing/Contacts

|        |      |     |
|--------|------|-----|
| 084529 | Blue | 1/0 |
|--------|------|-----|

#### Contacts

|            |    |     |
|------------|----|-----|
| 078724-002 | NA | 1/0 |
|------------|----|-----|



### 175 SB Ampere

| Part Number | Color | Cable Size |
|-------------|-------|------------|
|-------------|-------|------------|

#### Connector Housing

|            |        |    |
|------------|--------|----|
| 078723-002 | Gray   | NA |
| 078723-004 | Yellow | NA |
| 078723-007 | Red    | NA |
| 078723-008 | Blue   | NA |
| 078723-010 | Orange | NA |

#### Housing & Contact Kits

|            |        |     |
|------------|--------|-----|
| 077917-002 | Gray   | 1/0 |
| 077917-004 | Yellow | 1/0 |

#### Contacts

|            |    |     |
|------------|----|-----|
| 300452-001 | NA | 2   |
| 078724-002 | NA | 1/0 |

#### ▼ Accessories

| Part Number | Description |
|-------------|-------------|
|-------------|-------------|

#### Battery Connecting Handle

|            |                                   |
|------------|-----------------------------------|
| 340029-002 | Plastic, gray - includes hardware |
| 340029-003 | Plastic, red - includes hardware  |
| 340029-005 | Steel, red - includes hardware    |

#### Cable Clamp

|            |  |
|------------|--|
| 340056-002 | Includes hardware, use without handle              |
| 340056-003 | Includes hardware, used with "A Frame" handle only |

#### Drive Block

|        |                               |
|--------|-------------------------------|
| 077034 | For use with Quick Disconnect |
|--------|-------------------------------|



### SB 2/0

| Part Number | Description |
|-------------|-------------|
|-------------|-------------|

|            |  |
|------------|--|
| 340055-010 | SB 2/0 Gray Housing                    |
| 340055-011 | 2/0 or 70mm <sup>2</sup> Wire Contacts |
| 340055-009 | SB 2/0 Housing and Contact Kit         |

Extension of the SB175 series with outer dimensions that are identical to the SB175 but has been designed on to accept a contact for 2/0 or 70mm<sup>2</sup> wire. Contacts allow for UL rated currents up to 340 amps. Genderless designs allows it to mate with itself.



### 350 SB Ampere

| Part Number | Color | Cable Size |
|-------------|-------|------------|
|-------------|-------|------------|

#### Connector Housing

|            |        |    |
|------------|--------|----|
| 078723-001 | Gray   | NA |
| 078723-003 | Red    | NA |
| 078723-006 | Blue   | NA |
| 078723-009 | Yellow | NA |
| 078723-011 | Green  | NA |
| 078723-012 | Black  | NA |
| 378723-015 | Orange | NA |

#### Housing & Contact Kits

|            |      |     |
|------------|------|-----|
| 077917-001 | Gray | 2/0 |
| 077917-003 | Red  | 2/0 |
| 380000     | Blue | 2/0 |
| 370501-689 | Gray | 4/0 |

#### Contacts

|            |    |     |
|------------|----|-----|
| 078724-006 | NA | 1/0 |
| 078724-001 | NA | 2/0 |
| 078724-004 | NA | 3/0 |
| 078724-007 | NA | 4/0 |

#### ▼ Accessories

| Part Number | Description |
|-------------|-------------|
|-------------|-------------|

#### Battery Connecting Handle

|            |                                   |
|------------|-----------------------------------|
| 340029     | Plastic, gray - includes hardware |
| 340029-004 | Plastic, red - includes hardware  |
| 340029-005 | Steel, red - includes hardware    |

#### Cable Clamp

|            |   |
|------------|---|
| 340056-004 | Includes hardware; can be used with or without handle |
|------------|---|



### 160 SBE Ampere

| Part Number | Color | Cable Size |
|-------------|-------|------------|
|-------------|-------|------------|

#### Connector Housing

|            |       |    |
|------------|-------|----|
| 108801-005 | Red   | NA |
| 108801-007 | Black | NA |
| 108801-011 | Gray  | NA |
| 108801-012 | Blue  | NA |

#### Housing & Contact Kits

|            |     |   |
|------------|-----|---|
| 108800S005 | Red | 1 |
|------------|-----|---|

#### Contacts

|            |    |     |
|------------|----|-----|
| 340085     | NA | 1   |
| 108802-002 | NA | 1/0 |

#### Auxiliary Contact Kit

|        |           |
|--------|-----------|
| 340084 | SBE & SBX |
|--------|-----------|

#### Auxiliary Contact Crimp Tool Multi-Die Kit

|            |  |
|------------|--|
| 340084-001 | Crimps #6-20AWG SB, SBS, SBE, SBO, Powerpole, Saf-D-Grid, and SPEC Pak Connectors. Includes 3 dies and plastic case. |
|------------|--|

#### ▼ Accessories

| Part Number | Description |
|-------------|-------------|
|-------------|-------------|

#### Battery Connecting Handle

|            |                                   |
|------------|-----------------------------------|
| 340029-002 | Plastic, gray - includes hardware |
| 340029-003 | Plastic, red - includes hardware  |

#### Cable Clamp

|            |   |
|------------|---|
| 340056-005 | Includes hardware, use with or without handle |
|------------|---|



### 175 SBX Ampere

| Part Number | Color | Cable Size |
|-------------|-------|------------|
|-------------|-------|------------|

#### Connector Housing Kit

|            |        |     |
|------------|--------|-----|
| 340028-001 | Gray   | 1/0 |
| 340028-002 | Blue   | 1/0 |
| 340028-003 | Orange | 1/0 |
| 340028-004 | Yellow | 1/0 |
| 340028-005 | Red    | 1/0 |
| 340028-006 | Green  | 1/0 |

#### Contacts

|            |  |     |
|------------|--|-----|
| 108802-002 |  | 1/0 |
|------------|--|-----|

#### Auxiliary Contact Kit

|        |           |
|--------|-----------|
| 340084 | SBE & SBX |
|--------|-----------|

#### ▼ Accessories

| Part Number | Description |
|-------------|-------------|
|-------------|-------------|

#### Battery Connecting Handle

|            |                                  |
|------------|----------------------------------|
| 340029-002 | Plastic gray - includes hardware |
|------------|----------------------------------|

#### Cable Clamp

|            |                                   |
|------------|-----------------------------------|
| 340056-005 | Includes hardware, without handle |
|------------|-----------------------------------|

## Battery Connectors

### 320 SBE Ampere

| Part Number | Color | Cable Size |
|-------------|-------|------------|
|-------------|-------|------------|

#### Connector Housing

|            |        |    |
|------------|--------|----|
| 108801-001 | Gray   | NA |
| 108801-002 | Green  | NA |
| 108801-003 | Red    | NA |
| 108801-004 | Brown  | NA |
| 108801-006 | Blue   | NA |
| 108801-008 | Yellow | NA |
| 108801-010 | Black  | NA |

#### Housing & Contact Kits

|            |      |     |
|------------|------|-----|
| 108800-007 | Gray | 1/0 |
| 108800-001 | Gray | 2/0 |
| 108800-008 | Blue | 2/0 |
| 108800-006 | Red  | 3/0 |

#### Contacts

|            |    |     |
|------------|----|-----|
| 308802-001 | NA | 1/0 |
| 108802-001 | NA | 2/0 |
| 108802-003 | NA | 3/0 |
| 108802-004 | NA | 4/0 |

#### Auxiliary Contact Kit

|        |           |
|--------|-----------|
| 340084 | SBE & SBX |
|--------|-----------|

#### ▼ Accessories

| Part Number | Description |
|-------------|-------------|
|-------------|-------------|

|            |   |
|------------|---|
| 108437     | Drive Block used on P.N. 108800-006 & 108800-009. |
| 060015-025 | Screw   |
| 060005-006 | Lock washer                                       |
| 060021-006 | Nut   |
| 108852-002 | Contact Bushing used to go from 2/0 to 1/0        |

#### Battery Connecting Handle

|            |                                  |
|------------|----------------------------------|
| 340029     | Plastic gray - includes hardware |
| 340029-004 | Plastic, red - includes hardware |

#### Cable Clamp

|            |   |
|------------|---|
| 340056-006 | Includes hardware, use with or without handle |
|------------|---|

▲ **WARNING:** Cancer and reproductive harm - [www.P65Warnings.ca.gov](http://www.P65Warnings.ca.gov)

### Contact Bushing

| Part Number | Description |
|-------------|-------------|
|-------------|-------------|

|            |            |
|------------|------------|
| 108852-001 | 1/0 to 1   |
| 108852-002 | 2/0 to 1/0 |

■ Used on SB, SBE or SBX Contacts

### Manual Release Handle - SBE 320/SBX 350

Part Number - H47593-533

Charger/Truck Half  
(includes hardware)



Part Number - 340060-001

Battery Half  
(includes hardware)



### Manual Release Handle - SBX 175

Part Number - 340060-005

Charger/Truck Half  
(includes hardware)



Part Number - 340060-004

Battery Half  
(includes hardware)



### SB Extraction Tool

| Part Number | Amps |
|-------------|------|
|-------------|------|

|            |                 |
|------------|-----------------|
| 340089-001 | SBE160 / SBX175 |
| 340089-002 | SBE320 / SBX350 |

### 350 SBX Ampere

| Part Number | Color | Cable Size |
|-------------|-------|------------|
|-------------|-------|------------|

#### Connector Housing

|            |        |     |
|------------|--------|-----|
| 118802-001 | Gray   | 2/0 |
| 118802-002 | Blue   | 2/0 |
| 118802-003 | Red    | 2/0 |
| 118802-004 | Green  | 2/0 |
| 118802-005 | Black  | 2/0 |
| 118802-006 | Yellow | 2/0 |
| 340055-001 | Blue   | 4/0 |
| 340055-002 | Yellow | 4/0 |
| 340055-003 | Gray   | 4/0 |
| 340055-004 | Red    | 4/0 |
| 340055-005 | Gray   | 3/0 |
| 340055-006 | Blue   | 3/0 |
| 340055-007 | Red    | 3/0 |
| 340055-008 | Yellow | 3/0 |

#### Connector Housing

|            |        |
|------------|--------|
| 340090-001 | Gray   |
| 340090-002 | Blue   |
| 340090-003 | Black  |
| H24985-502 | Red    |
| 340350-005 | Green  |
| 340350-006 | Orange |
| 340350-007 | Yellow |

#### Contacts

|            |     |
|------------|-----|
| 108802-001 | 2/0 |
| 108802-003 | 3/0 |
| 108802-004 | 4/0 |

#### Auxiliary Contact Kit

|        |           |
|--------|-----------|
| 340084 | SBE & SBX |
|--------|-----------|

#### ▼ Accessories

| Part Number | Description |
|-------------|-------------|
|-------------|-------------|

#### Battery Connecting Handle

|        |                                   |
|--------|-----------------------------------|
| 340029 | Plastic, gray - includes hardware |
|--------|-----------------------------------|

#### Cable Clamp

|            |   |
|------------|---|
| 340056-006 | Includes hardware, use with or without handle |
|------------|---|



#### Complete Kit - P.N. 139685

Includes: 2 each of H47593-533 and 340060-001 manual release handles, 1 each of 118802-001 & 118802-003 connectors with 2/0 terminals.

## A320

### Crown Part Number Description

| A320 Complete Kits - handle, auxiliary tips, clamp and carrier    |   |
|---|---|
| 340320-115  | A320 Conn- Male Pin, 1/0                    |
| 340320-215  | A320 Conn- Male Pin, 2/0                    |
| 340320-315  | A320 Conn- Male Pin, 3/0                    |
| 340320-415  | A320 Conn- Male Pin, 4/0                    |
| 340320-105  | A320 Conn- Female Skt, 1/0 - without handle |
| 340320-205  | A320 Conn- Female Skt, 2/0                  |
| 340320-305  | A320 Conn- Female Skt, 3/0                  |
| 340320-405  | A320 Conn- Female Skt, 4/0                  |
| A320 Kits - Do not include contact tips, auxiliary tips or handle |   |
| 340320-211  | A320 Kit- Male Pin Hsg, Clamps, Carrier     |
| 146345-001  | A320 Kit- Female Skt Hsg, Clamps, Carrier   |
| A320 Connectors with Contacts                                     |   |
| 340320-112  | A320 Conn- Male Pin, 1/0                    |
| 340320-212  | A320 Conn- Male Pin, 2/0                    |
| 340320-312  | A320 Conn- Male Pin, 3/0                    |
| 340320-412  | A320 Conn- Male Pin, 4/0                    |
| 340320-102  | A320 Conn- Female Skt, 1/0                  |
| 340320-202  | A320 Conn- Female Skt, 2/0                  |
| 340320-302  | A320 Conn- Female Skt, 3/0                  |
| 340320-402  | A320 Conn- Female Skt, 4/0                  |
| A320 Auxiliary Tips   |   |
| 340320-012  | A160/320 Aux Pin Contact, Lower #10 6mm AWG |
| 340320-013  | A160/320 Aux Pin Contact, Upper #12 4mm AWG |
| 340320-002  | A320 Aux Pin Contact, Lower, 14/18 AWG      |
| 340320-003  | A320 Aux Skt Contact, Lower, 14/18 AWG      |
| 340320-004  | A320 Aux Pin Contact, Upper, 14/18 AWG      |
| 340320-005  | A320 Aux Skt Contact, Upper, 14/18 AWG      |
| A320 Contact Tips   |   |
| 340320-006  | A320 Contact, Male Pin, 2/0                 |
| 340320-007  | A320 Contact, Male Pin, 3/0                 |
| 340320-008  | A320 Contact, Male Pin, 4/0                 |
| 340320-009  | A320 Contact, Female Skt, 2/0               |
| 340320-010  | A320 Contact, Female Skt, 3/0               |
| 340320-011  | A320 Contact, Female Skt, 4/0               |

340320-405 / 341227-125



340320-201 / 341227-122



340320-212 / 341227-112



340320-402 / 341227-122



340320-002



340320-003



340320-004



340320-005



340320-006 / 341227-003



340320-009 / 341227-002



## A160

### Crown Part Number Description

| A160 Complete Kits - handle, auxiliary tips, clamp and carrier    |   |
|---|---|
| 341227-115  | A160 Conn- Male Pin, 1/0                    |
| 341227-125  | A160 Conn- Female Skt, 1/0                  |
| A160 Kits - Do not include contact tips, auxiliary tips or handle |   |
| 341227-112  | A160 Conn- Male Pin, 1/0                    |
| 341227-122  | A160 Conn- Female Skt, 1/0                  |
| A160 Auxiliary Tips   |   |
| 340320-012  | A160/320 Aux Pin Contact, Lower #10 6mm AWG |
| 340320-013  | A160/320 Aux Pin Contact, Upper #12 4mm AWG |
| A160 Contact Tips   |   |
| 154292-001  | A160 Contact, Male Pin 1/0                  |
| 341227-002  | A160 Contact, Female Pin 1/0                |

## A160/A320

### Crown Part Number Description

|        |                                   |
|--------|-----------------------------------|
| 340333 | DIN Voltage Key 160/320A Standard |
|--------|-----------------------------------|



## Battery Connectors - EURO and DIN

### A320/A160 Tools and Accessories

| Crown Part Number | Description                                     |
|-------------------|---|
| 340320-001        | A160 & A320 Handle                              |
| 340327            | Latch Plate w/hardware                          |
| 340328            | A-Frame Handle for Latch, w/hardware            |
| 340329            | Hand Crimp Tool - crimps auxiliary DIN contacts |

### A320 (only) Tools and Accessories

| Crown Part Number  | Description   |
|--|---|
| 340060-002   | A320 Manual Release Brkt. Battery half  |
| 340060-003   | A320 Manual Release Lever, Charger/Truck Half                                       |
| 340321   | Crimp Tool-A320 Aux Contacts  |
| 340323   | Crimp Tool-Battery Powered; hand held hydraulic tool that uses dies 340325 & 340326 |
| 340324   | Crimp Tool-Hand held hydraulic tool that uses dies 340325 & 340326                  |
| 340331   | Die Set - 6-12 guage - use with 340321  |
| 340325   | Die Set-2/0 - use with 340323 & 340324  |
| 340326   | Die Set-3/0-4/0 - use with 340323 & 340324  |
| 352236  | Couple/Adapter Female Euro 320  |



340320-001

340327



352236

340328



### LV500 Ampere

| Part Number              | Color | Description          |
|--------------------------|-------|----------------------|
| <b>Connector Housing</b> |       |                      |
| 340500-105               | Blue  | LV500 Battery Socket |
| 340500-115               | Blue  | LV500 Charger Plug   |



Battery Socket



Charger Plug

### LV400 Ampere

| Part Number  | Color | Description  |
|--|-------|--|
| <b>Connector Housing Kit with Coding Pin, Pilot and Auxillary Contacts</b> |       |  |
| 340400-105*  | Black | LV400 Battery Socket for 4/0 (95MM2) Cable             |
| 340400-115**   | Black | LV400 Charger Plug for 4/0 (95MM2) Cable               |
| 364984-001   | Red   | Battery Socket and Charger Plug Replacement Coding Pin |



Battery Socket



Charger Plug

\*V-Force LI1100 Replacement Charge Port Connector

\*\*Lithium Ion Charge Harness Replacement Battery End Connector

### DIN320 Ampere

| Part Number  | Color | Description                                     |
|--|-------|---|
| <b>Connector Housing Kit with Coding Pin, Pilot and Auxillary Contacts</b> |       |   |
| 339320-105   | Black | DIN320 Battery Socket Kit for 4/0 (95MM2) Cable |
| 339320-115   | Black | DIN320 Charger Plug for 4/0 (95MM2) Cable       |
| 164980-002   | Blue  | Battery Socket Replacement Coding Pin           |
| 164980-001   | Blue  | Charger Plug Replacement Coding Pin             |

**Power Cable**

| Gauge | Color  | UL Rated | Bulk Part Number | 10 ft box<br>305 cm | 12 ft box<br>366 cm | 50 ft reel,<br>1,524 cm | 100 ft reel,<br>3,048 cm | 250 ft reel,<br>7,620 cm | 500 ft reel,<br>15,240 cm |
|-------|--------|----------|------------------|---------------------|---------------------|-------------------------|--------------------------|--------------------------|---------------------------|
| 6     | black  | UL       | 084568-010       |                     | 384568-012          |                         |                          |                          |                           |
| 4     | black  | UL       | 084569-105       | 384569-010          | 384569-012          | 384569-050              | 384569-105               | 384569-250               |                           |
| 4     | red    | UL       | 384575-001       |                     | 384575-012          | 384575-050              | 384575-100               |                          |                           |
| 2     | black  | UL       | 084570-100       |                     | 344570-012          | 344570-050              | 344570-100               |                          | 344570-500                |
| 2     | red    | UL       | 384576-001       |                     | 384576-012          | 384576-050              | 384576-100               |                          |                           |
| 1     | black  | UL       | 084571-100       |                     | 344571-012          | 344571-050              | 344571-100               |                          |                           |
| 1     | red    | UL       | 384571-001       |                     | 384571-012          | 384571-050-02           | 384571-100-02            |                          |                           |
| 1/0   | black  | UL       | 084572-021       |                     | 384572-012          | 384572-050              | 384572-100               |                          |                           |
| 1/0   | red    | UL       | 384574-001       |                     | 384574-012          | 384574-050              | 384574-100               |                          |                           |
| 2/0   | black  | UL       | 084573-013       |                     | 384573-012-B        |                         | 384573-100               | 384573-250               |                           |
| 2/0   | red    | UL       |                  |                     | 384573-012-R        |                         | 384573-100-02            | 384573-250-0R            |                           |
| 2/0   | red    | not UL   | 384573-013R      |                     | 384573-012R         |                         | 384573-013               |                          |                           |
| 2/0   | orange | not UL   | 384573-014O      |                     | 384573-012-O        |                         | 384573-014               |                          |                           |
| 3/0   | black  | UL       |                  |                     | 384579-012-B        |                         | 384579-100-01            |                          |                           |
| 3/0   | red    | UL       |                  |                     | 384579-012-R        |                         | 384579-100-02            |                          |                           |
| 4/0   | black  | UL       | 384577-100-01    |                     | 384577-012          |                         | 384577-100               |                          |                           |
| 4/0   | red    | UL       |                  |                     | 384577-012-R        |                         |                          |                          |                           |
| 4/0   | red    | not UL   | 384578-100-01    |                     | 384578-012          |                         | 384578-100               |                          |                           |

▲WARNING: Cancer and reproductive harm - www.P65Warnings.ca.gov

BATTERY AND CHARGER



384000-XXX



384001-XXX

**Cable End - Copper Tin Plated**

| AWG | Wire Size | Stud Size | Description | Part Number |
|-----|-----------|-----------|-------------|-------------|
| 4   | 0.344     | 0.344     | straight    | 384000-004  |
| 6   | 0.344     | 0.344     | straight    | 384000-006  |
| 1/0 | 0.344     | 0.344     | straight    | 384000-001  |
| 2/0 | 0.344     | 0.344     | straight    | 384000-002  |
| 3/0 | 0.344     | 0.344     | straight    | 384000-003  |
| 4/0 | 0.344     | 0.344     | straight    | 384000-040  |
| 4   | 0.344     | 0.344     | 90° angle   | 384001-003  |
| 6   | 0.344     | 0.344     | 90° angle   | 384001-004  |
| 1/0 | 0.344     | 0.344     | 90° angle   | 384001-001  |
| 2/0 | 0.344     | 0.344     | 90° angle   | 384001-002  |



**Expandable Sleeving - White**

| Part Number | Size                 | Expansion Range (Min. - Max.) |
|-------------|----------------------|-------------------------------|
| 300472-225  | 1/8" - 225 ft. roll  | 3/32" - 1/4"                  |
| 300473-200  | 1/4" - 200 ft. roll  | 1/8" - 3/8"                   |
| 300474-100  | 1/2" - 100 ft. roll  | 1/4" - 3/4"                   |
| 300475-075  | 3/4" - 75 ft. roll   | 1/2" - 1 1/4"                 |
| 300476-050  | 1 1/4" - 50 ft. roll | 3/4" - 1 3/4"                 |
| 300477-050  | 1 3/4" - 50 ft. roll | 1 1/4" - 2 1/2"               |
| 300478-050  | 2" - 50 ft. roll     | 1 5/16" - 2 3/8"              |

▲WARNING: Cancer and reproductive harm - www.P65Warnings.ca.gov

- Highly wear resistant; Resists acids, bases, solvents
- Flammability Rating UL-94, FAR25, V-O
- Cut and abrasion resistant
- Ultra light weight
- Expands up to 150%



**Automotive Battery Connectors, 10 per package**

| Part Number | Single Piece | Description                                 | Specifications   |
|-------------|--------------|---|--|
| 300457-010  | 300457-001   | Heavy Duty Universal Top Post Lead Terminal | Clamps designed for truck, bus, construction, agriculture & industrial applications. Accepts 1 thru 4/0 gauge cable sizes. |
| 300458-010  | 300458-001   | Automotive Universal Top Post Lead Terminal | Automotive and light truck applications. Accepts 6 thru 2/0 gauge cable sizes.   |

▲WARNING: Cancer and reproductive harm - www.P65Warnings.ca.gov

300457-010



300458-010



**Expandable Sleeving - Black**

| Part Number | Size                  | Expansion Range (Min. - Max.) |
|-------------|-----------------------|-------------------------------|
| 300467-050  | 3/4" - 50 ft. roll    | 5/8" - 1"                     |
| 300467-100  | 3/4" - 100 ft. roll   | 5/8" - 1"                     |
| 300456-100  | 1 1/4" - 100 ft. roll | 1" - 1 1/2"                   |

▲WARNING: Cancer and reproductive harm - www.P65Warnings.ca.gov

- Fray resistant, cuts with scissors
- High abrasion resistance
- Increased braid density for better coverage
- Will fit both negative & positive cables from 1 gauge to 4/0 gauge



**Cable Ties**

| Part Number | Length (in) | Width (in) | Max. Wire Bundle | Color   | Qty Per Box |
|-------------|-------------|------------|------------------|---------|-------------|
| 365003-002  | 3.62        | 0.09       | 0.63             | Natural | 1000        |
| 365003-003  | 7.44        | 0.19       | 1.75             | Natural | 1000        |
| 365003-004  | 5.60        | 0.14       | 1.38             | Black   | 1000        |
| 365003-005  | 11.40       | 0.14       | 3.00             | Black   | 1000        |
| 18108-X     | 14.00       | 0.3125     | 4.00             | Black   | 100         |



**Expandable Sleeving - Red**

| Part Number | Size                  | Expansion Range (Min. - Max.) |
|-------------|-----------------------|-------------------------------|
| 300468-075  | 3/4" - 75 ft. roll    | 3/4" - 1 1/4"                 |
| 300468-250  | 3/4" - 250 ft. roll   | 3/4" - 1 1/4"                 |
| 300469-050  | 1 1/4" - 50 ft. roll  | 3/4" - 1 3/4"                 |
| 300469-250  | 1 1/4" - 250 ft. roll | 3/4" - 1 3/4"                 |

▲WARNING: Cancer and reproductive harm - www.P65Warnings.ca.gov

- Cut and abrasion resistant
- Resists gasoline, engine chemicals and cleaning solvents
- Economical and easy to install
- FMVSS 302 Approval
- Not anti-fray





## Power Cable and Accessories

### Heat Shrink Tubing



| Part Number   | Color | Expanded Dia. (in) | Shrunk Dia. (in) | Gauge Size   | Length |
|---------------|-------|--------------------|------------------|--------------|--------|
| 300414-001    | Black | 0.75               | 0.25             | 4 thru 2/0   | 6 in.  |
| 300414-005-04 | Black | 0.75               | 0.25             | 4 thru 2/0   | 4 ft.  |
| 300414-002    | Red   | 0.75               | 0.25             | 4 thru 2/0   | 6 in.  |
| 300414-006-04 | Red   | 0.75               | 0.25             | 4 thru 2/0   | 4 ft.  |
| 300414-003    | Black | 1.125              | 0.375            | 1/0 thru 4/0 | 6 in.  |
| 300414-007-04 | Black | 1.125              | 0.375            | 1/0 thru 4/0 | 4 ft.  |
| 300414-004    | Red   | 1.125              | 0.375            | 1/0 thru 4/0 | 6 in.  |
| 300414-008-04 | Red   | 1.125              | 0.375            | 1/0 thru 4/0 | 4 ft.  |

**WARNING:** Cancer and reproductive harm - [www.P65Warnings.ca.gov](http://www.P65Warnings.ca.gov)

- Double-wall with extra meltable sealant
- Premium quality for heavy duty applications or for use in abusive environments requiring protection from abrasion
- Inner surface lined with adhesive sealant which melts when heated; permanently seals connection as tube cools & shrinks
- Conforms to DOD Mil-DTL-23053/15A Class 1 & 2 specifications

### Gum Rubber Tubing



#### Part Number Description

|            |  |
|------------|--|
| 300483-050 | Highly flexible, seamless tubing free of curvature with a non-slip outside finish for easy handling. Resists weak acids, alkalis and salts. Highly abrasion resistant. |
|------------|--|

- 1/4" ID x 1/8" 50 ft.

## Battery Acid Indicators

### Blinky



#### Part Number Probe Length

|            |       |
|------------|-------|
| 340011-007 | 2.35" |
| 340011-008 | 5"    |

Blinky Basic option is a low-cost solution for accurate electrolyte monitoring. The LED is twice as bright as the previous model and the housing is more robust. LED blinks green when the electrolyte level is good and goes out when water is required.

### Smart Blinky



#### Part Number Probe Length

|            |       |
|------------|-------|
| 340011-009 | 2.35" |
| 340011-011 | 5"    |

Ideal for batteries where the top of the battery can be seen. The LED is 8 times brighter than the previous model. The electrolyte probe and LED are integrated into the same housing. The LED blinks green when the electrolyte level is good and blinks red when water is needed. The design has an "installation forgiveness zone!" This system works on 6V and 12V block and golf cart batteries.

### Smart Blinky Pro



#### Part Number Probe Length

|            |       |
|------------|-------|
| 340011-012 | 2.35" |
| 340011-015 | 5"    |

Intelligent battery monitoring with both light and sound. SmartBlinky Pro provides a bright electrolyte level indicator to know when to fill a battery. The LED is mounted on the battery cable near the connector for maximum visibility - perfect for opportunity and fast applications in which the battery never leaves the truck. SmartBlinky Pro is rugged, built to withstand the harsh environment of industrial battery applications, and UL classified.

### Smart Blinky Remote



#### Part Number Probe Length

|            |       |
|------------|-------|
| 340011-010 | 2.35" |
|------------|-------|

Ideal for batteries that do not leave the truck or batteries that are changed on multi-level racks because the indicator LED can be edge mounted for high visibility. The LED is 6 times brighter than the previous model. The LED housing has a lower profile and is more robust. The LED blinks green when the electrolyte level is good and blinks red when water is needed. The design has an "installation forgiveness zone!" This system works on 6V and 12V block and golf cart batteries.

## Battery Tools

Continued ▶



### QuickStrip Pro - Cable Strippers

Part Number - 300412

- Strips insulation from cable 10 - 250 mcm
- Includes spare blade

Replacement Blade: P.N. 300412-001

**WARNING:** Cancer and reproductive harm - [www.P65Warnings.ca.gov](http://www.P65Warnings.ca.gov)



### QuickStrip - Cable Strippers

Part Number - 300411

- Strips insulation from cable 10 - 4/0 gauge
- Includes spare blade

Replacement Blade: P.N. 300418

**WARNING:** Cancer and reproductive harm - [www.P65Warnings.ca.gov](http://www.P65Warnings.ca.gov)

**Post Drill Bit, 2 Flute**

Part Number - 300404

Designed for Leadheads, FastCharge Leadheads and Intercells.

- Extra tall flutes allow drilling depth of up to one inch
- 1 inch O.D. leaves a .70 inch post
- Tool length 5 inches
- Center pin to guide drill straight
- Can be resharpened
- Use centerless drill for deep bore
- Use Penetrating Lubricant: P.N. 363104-001

- 1 Three flats on shank prevent spinning in chuck
- 2 Extra tall flutes improve drilling depth in thick leadheads; Wide flutes prevent chip pile-up
- 3 Electroplating improves corrosion resistance



**Post Builder Mold**

Part Number - 300405

- Create a post on batteries or intercells
- Post mold is tall enough that when leadhead is attached, the post will burn down and fill leadhead cavity, creating tight seal
- Enables you to add a leadhead where needed

- 1 Tapered mold for ease of release
- 2 Handle to break mold free from new post

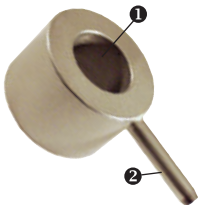

**Solder Pellets**

| Part No.   | Description              |
|------------|--------------------------|
| 362402-033 | 1/0 Black Solder Pellet  |
| 362402-034 | 2/0 Orange Solder Pellet |
| 362402-035 | 3/0 Purple Solder Pellet |
| 362402-036 | 4/0 Yellow Solder Pellet |

Used instead of hex crimper for tasks such as soldering battery contact tips to cables



**Butane Torch**

Part Number - 300408

Butane Torch used for heat shrink applications along with soldering of some smaller connectors. Not used to repair batteries.



**Battery Tester**

Part Number - 320070

100 amp battery tester. 300 amp extended jaw. Tests: battery load tests, starters & alternators, battery state of charge.



**Fluke 325 True RMS Clamp Meter**

Part Number - 109040

Rugged, reliable True-RMS clamp meter with DC current and frequency measurements. Measures AC and DC voltages to 600 V. Measured AC and DC current to 400 A. Provides True RMS AC voltage and current for accurate measurements on non-linear signals. Measures frequency to 500 Hz. Measures resistance to 40 kilo-ohms with continuity detection.



**Hydrometer - Glass**

Part Number - 300406

- Professional quality for highest accuracy
- Precision graduated specific gravity float
- Overall Length 13.5 inches, glass barrel 8 inches long



**Hydrometer - Glass**

Part Number - 300406-001

- Scientifically designed and precisely calibrated
- Float has a specific gravity range of 1.100 to 1.300
- Overall length of the set is 12 inches



**Hydrometer - Plastic**

Part Number - 300407

- Professional quality for highest accuracy
- Precision graduated specific gravity float



**10mm x 1.5 Bottom Tap**

Part Number - 322270



**Torque Wrench with 3/8 DR. Rat.**

Part Number - 322271



**Lead Sticks**

Part Number - 300417-035 (35 - 1 lb sticks)

- Made of 5 percent antimonial lead
- Clean melting alloy, free of foreign material, voids and porosity
- Sticks are 12 inches long (30.5 cm) and weigh 1lb (.45 kg)

▲WARNING: Cancer and reproductive harm - www.P65Warnings.ca.gov



**Carbon Arc Burner**

Part Number - 300440

- No Flame
- Use voltage from battery to melt lead to repair battery

▼ **Accessories**

**Copper Coated Electrodes**

Part Number - 300441-050

- For use with Carbon Arc Burner
- 50 in a box

▲WARNING: Cancer and reproductive harm - www.P65Warnings.ca.gov



**Hole Cutter**

Annular Cutters - Hougen

Part Number - MSC98382922

Diameter: 1 5/16". Cutting depth: 1/2".

Precision ground to produce burr-free holes up to 1/2" deep. Ideal for electrical, piping, conduit, sheet metal & HVAC applications. High-speed steel provides good wear resistance and can be used in general purpose applications for both ferrous and nonferrous materials.



**Hole Cutting Tool Arbor**

Shank with Pilot Pin - Hougen

Part Number - MSC98380876

Minimum tool diameter compatibility: 1 5/16". Maximum tool compatibility: 1 1/2". Shank diameter: 1/2". No. of flats: 3. Material: Steel. Weldon flat: No.

Straight shanks are used for general purpose applications. The shank is smaller than the drill bit diameter. They are used with portable drills and drill presses on ferrous and nonferrous materials.



**Weldex 113 Plier**

Part Number - 306442

- Designed for the safe and easy removal of contacts from the SB or SBX connectors
- Works on either 175 or 350 Connectors



**Brute Hammer Crimper**

Part Number - 300465

- Use with hammer, vise or press
- Crimps 8 thru 4/0 guage connectors
- Spring loaded pin locks in "up" position for loading connector and cable. When released, pin holds connector securely during crimping.
- 6-month warranty



**T-Handle with 10mm thread**

Part Number - 352228

Used for removing V-Force lithium-ion model V-LI1100 modules and V-Force lead-acid models V-LA1120 and V-LA1130 lead-acid cells.



**Adjustable Torquing Screw Driver**

Part Number - 360043-015

Torques from .5 - 4.5 Newton Meters / 50-450 Newton Centimeters. Used for servicing V-Force HFM3 charger electrical connections.



**Long 1/4" Hex, 3mm Bit**

Part Number - 360043-016

Used for servicing V-Force HFM3 charger electrical connections.



**1/4" Drive Metric Hex Bit Sockets**

| Part Number | Description              |
|-------------|--------------------------|
| 360043-007  | 1/4" Drive 2mm Hex Bit   |
| 360043-008  | 1/4" Drive 2.5mm Hex Bit |
| 360043-009  | 1/4" Drive 3mm Hex Bit   |
| 360043-010  | 1/4" Drive 4mm Hex Bit   |
| 360043-011  | 1/4" Drive 5mm Hex Bit   |

Used for servicing V-Force Lithium Ion Batteries with 1/4" Drive Socket Set P.N. 322000.



360061

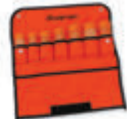

360062



360063



360064



360065



360066



360067

These tools are designed to improve safety on electrical jobs with UL classified non-conductive composite.

- Exceeds all ISO and ASME strength and performance requirements for standard steel tools
- Individually tested to ensure protection up to 1000Volt AC and 1500 Volt DC
- UL Classified
- Lifetime warranty for material and workmanship

| Part No. | Description  |
|----------|--|
| 360061   | Insulated Socket Set - Standard Includes: Sockets 3/8", 7/16", 9/16", 5/8", 11/16", 3/4"; Ratchet & Kit Bag          |
| 360062   | Insulated Socket Set - Metric Includes: Sockets 10mm, 13mm, 15-19mm, 22mm; Kit Bag                                   |
| 360063   | Non-Conductive Screwdriver set - Includes: Flat tip Screwdrivers 3/16", 1/4" 9/32"; Phillips Screwdrivers #1, #2, #3 |
| 360064   | 3/8" x 3" Extension  |
| 360065   | 3/8" x 6" Extension  |
| 360066   | 1/2" x 3/8" Adaptor  |
| 360067   | Non-Conductive Needle Nose Pliers  |
| 360068   | JHWR-24A Tool Pouch  |
| 360069   | Torque Wrench 10Nm - 60Nm  |
| 360070   | Battery Tool Bag for all of the above parts  |



360068



360069



360070

## Battery Tools



### Clamp

Part Number - 320056

- Use two of these clips to lift out battery cells.
- See DP module for instructions.



### Cell Puller

Part Number - 320056-003

- Tool used to aid in removal of battery cells. Recommended quantity: 2.
- 500 lb. capacity



### Cell Jar Puller

Part Number - 320056-004

- Tool used to aid in removal of battery jars. Recommended quantity: 2.
- 500 lb. capacity



### Cell Pressure Tester

Part Number - 320075

- Test battery cells for leaks.
- Attach to the vent well, squeeze the bulb gauge, and indicator will show pressure.



### Hex Crimp 24 inch

Part Number - 300410-002

- Crimps 8 thru 4/0 gauge cable
- Crimps all major brands of connectors
- Hand held
- 24 inch handles
- Lifetime warranty



### 26" Hex Crimp Repair Kit

Part Number - 300410-001

- Includes 2 dies, 2 springs, 2 pins and 2 washers



### Carrying Case for Crimp Tools

Part Number - 300454



### Quick Cutter 2 - Heavy-Duty Cutter

Part Number - 300409

- Hand held
- Cuts cable up to 6/0 gauge
- 22 inch handle for easier cutting
- Blades made of 1075 carbon steel, hardened for long life, can be resharpened
- Made in North America
- 2-year warranty

### Oxygen & Acetylene Torch Welding & Regulator Kit

Part Number - 300470

#### Includes:

- Cylinder Carrier
- WH270FC-V Torch Handle
- CA270-V Cutting Attachment
- 150 Series Regulators with 2" Gauges
- 0-3-101 Cutting Tip
- 2-W-1 Welding Nozzle
- Hose
- Striker
- Goggles
- 20 cu. ft. Oxygen Cylinder
- MC Acetylene Cylinder
- Gas Not Included



⚠ **WARNING:** Cancer and reproductive harm - [www.P65Warnings.ca.gov](http://www.P65Warnings.ca.gov)

### Replacement Parts for 300442, Oxygen & Acetylene Torch Kit

| Part Number | Description               | Quantity |
|-------------|---------------------------|----------|
| 300443      | Welding Nozzle, 0-W-1     | 1        |
| 300444      | Cutting Tip, 0-3-101      | 1        |
| 300445      | Cutting Attachment        | 1        |
| 300446      | Welding Handle            | 1        |
| 300447      | Regulator Oxygen          | 1        |
| 300448      | Regulator Acetylene       | 1        |
| 300449      | 3/16" x 12-1/2" Hose Twin | 1        |
| 300450      | 2001 Spark Lighter Single | Box (10) |

⚠ **WARNING:** Cancer and reproductive harm - [www.P65Warnings.ca.gov](http://www.P65Warnings.ca.gov)



### SB Extraction Tool

| Part Number | Amps            |
|-------------|-----------------|
| 340089-001  | SBE160 / SBX175 |
| 340089-002  | SBE320 / SBX350 |



### Coolant/Battery Acid Refractometer

Part Number - 390221

Portable Coolant Refractometer, Coolant/Battery Acid 1.15 to 1.30. Specific Gravity of Battery Acid. Measures the freezing point of coolants and the charge condition of batteries.

⚠ **WARNING:** Cancer and reproductive harm - [www.P65Warnings.ca.gov](http://www.P65Warnings.ca.gov)

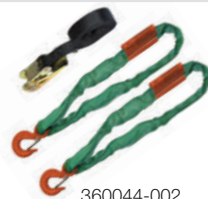

### Battery Lifting Strap Kit

| Part No.   | Description  |
|------------|--|
| 360044-002 | Battery Lifting Strap Kit                                    |
| 300136     | Ratchet Loadstrap  |
| 360044-001 | 3000 lb Capacity Battery Cell Extractor Strap w/Compact Hook |
| 360044     | 5300 lb Capacity Battery Cell Extractor Strap w/Hook         |

300136

360044

**Wash Water Neutralizer**

Part Number Sales Unit

300415-005 | 5 Gallon



Used to adjust pH in wash water and clean acid contaminated floors and equipment such as battery racks and delivery vehicles.

- Concentrated sulfuric acid neutralizer
- Non-corrosive and non-hazardous
- Allows for reuse of wash water
- Can also be used to remove acid from concrete floors
- Use on Reusable Battery Acid Floor and Counter Mat P.N. 300403-050



\*Wash Water

**Reusable Battery Acid Floor and Counter Mat**

Part Number Size (ft)

300403-050 | 3 x 50 roll (can be cut easily)

- Absorbs 6 oz. of acid per square foot
- Cut to size for battery compartments, storage racks or drip pans
- Mat absorbs acid but won't leak through tough polypropylene backing
- Electrically isolates battery, preventing parasitic discharge
- Use on floor or under the battery
- Use mat over and over again

\*Note: Use Wash Water Neutralizer P.N. 300415-005 on mat and sweep it up with shop vac.

Image Not Available

**Battery Cell Bag**

Part Number Description

300481-025 | 24" x 36" - 25/box

300482-025 | 24" x 48" - 25/box

Extra heavy-duty Poly Bags are puncture resistant and recommended for transporting industrial battery cells. Bags are manufactured from 100% virgin, high clarity polyethylene film. Meets FDA and USDA specifications. Close bags with twist ties, bag tape or by heat sealing.



**Battery Protector**

Part Number Sales Unit

363125-001 | Net wt 15 oz Can

Heavy-duty industrial, non-methylene chloride, battery protector extends battery life and prevents corrosion. It provides an air-tight, waterproof seal, and resists oil, gasoline, dirt, grease and heat. Assures maximum electrical connectivity.



**Battery Cleaner**

Part Number Sales Unit

363124-001 | Net wt 18 oz Can

Heavy-duty industrial battery cleaner is engineered for fast, effective, economical maintenance of storage battery terminals, hold-downs, cables and battery boxes. It detects leaks by changing from yellow to reddish purple when it comes in contact with acid.

⚠ WARNING: Cancer - [www.P65Warnings.ca.gov](http://www.P65Warnings.ca.gov)

**Industrial Battery Cleaner/ Neutralizing Wash Cleaner**

Part Number Sales Unit

300422-001 | Quart

300422 | 5 Gallon

300422-035 | 35 Gallon



- Dissolves corrosion, eliminates acid shorts
- Stops damaging corrosion
- Allows for reuse of wash water
- Safe to use on all industrial and starter batteries
- Neutralizing Wash Cleaner with color change, turns purple when acid is present and back to yellow when safe

Wash Cleaner color indicates when acid is neutralized.

Acid Present Neutralizing Safe

Note: Protective acid resistant goggles and gloves are recommended.

**Acid Spill Absorber and Neutralizer**

Part Number Sales Unit Absorbs

300421 | 25 lbs. | 6 gallons of electrolyte

300421-030 | 160 lbs. | 40 gallons of electrolyte



- Specifically formulated to absorb and neutralize battery acid, with color change to show when acid is neutralized and safe for disposal
- Ideal for use in acid drip pans
- Safe and non-hazardous
- Sweeps up clean and dry, is not dusty like kitty litter/clay
- Durable easy to store container with resealable lid
- Instructions and MSDS included See OSHA 1926.441 & 1910.173

**Black Battery Reconditioner**

Part Number Sales Unit

363133-001 | Net wt 12 oz Can



Restores battery to original look. Formulated to adhere to battery plastics and metal. Ideal for automotive, truck and industrial batteries. When dry, paint finish resembles gloss of original molded plastic. Industrial grade, high solids for single coat coverage, outstanding hardness and durability, resists abrasion and heat. Fast drying. Other uses include battery hold-downs, trays and cases.

**Apron\***

1 Apron

Part Number Description

365260-001 | Black heavy weight Neoprene apron, excellent protection against acids, oils, and chemicals. Reinforced 65/35 Cotton/Polyester blend backing. 4 grommets & polyester string ties. 18 oz. weight (heavy weight). 35" x 45"



\* Available only to customers in USA

## Battery Service Supplies

### Battery Spill Kit\*

Part Number - 300035

#### ▲ Individual Items

| Part Number | Description  | Quantity  |
|-------------|--|-----------|
| 300042      | Faceshield   | 1         |
| 300041      | Headgear   | 1         |
| 300049      | 32 oz Acid neutralizer (per bottle)                | 2 bottles |
| 300043      | Acid spill absorbent cleanup pads                  | 10        |
| 300047      | Yellow heavy-duty chemical disposal bag; 33" x 39" | 1         |
| 300048      | Mini broom   | 1         |
| 300051      | 16 oz eye wash flush**                             | 1 bottle  |
| 300044      | Green acid resistant glove, nitrile                | 1 pair    |
| 300045      | Acid-resistant sleeve                              | 1 pair    |
| 300050      | Acid-resistant rubber overboot                     | 1 pair    |
| 300046      | Acid-resistant apron                               | 1         |
| 300035-001  | Bucket   | 1         |



\*\*Three-year shelf life. **Notes:** Individual part numbers sold by piece or pair; Instructional label inside lid.



### 16 Gallon Eye Wash Station\*

| Part Number | Sales Unit |
|-------------|------------|
| 365466      | 1 kit      |

Size: 20.5" length, 18" width, 20.5" height. 15 minute flow, required by ANSI Z358.1-2009. Includes steel wall bracket, 2 oz. sterile water solution, and test log and drainage hose. Drain and refill every 4 months with 2 oz. solution, part number 365474.



### Eye Wash Station\*

| Part Number | Sales Unit |
|-------------|------------|
| 365468      | 1 kit      |

Two bottle wall-mounted eye wash station. Includes two 16 oz. bottles of sterile eye wash. Easily mounts to any wall.



### Water Additive\*

| Part Number | Sales Unit           |
|-------------|----------------------|
| 365474      | 8 oz. bottle/12 case |

Add to water for 16 gallon eye wash station to eliminate contamination from stagnant water. 8 oz. per 16 gallon refill.



### Replacement Bottle of Eye Wash\*

| Part Number | Sales Unit        |
|-------------|-------------------|
| 365469-001  | One 16 oz. bottle |

Sterile eye wash. Can be used alone or with 365468 eyewash station.

\*Available only to customers in USA

## Now Available:



**Low Profile  
Parts hopper**  
See Page 3.16



**Electric  
Brake**  
See Page 4.56



**Seat  
Cushion**  
See Page 5.06



# Section 9

# Tools

## Contents

|                                |      |
|--------------------------------|------|
| Crown Branded Tool Program     | 9.02 |
| Mechanical Tools               | 9.05 |
| Hydraulic Tools                | 9.09 |
| Drive Tools                    | 9.13 |
| Diagnostic Tools               | 9.14 |
| Steering Tools                 | 9.16 |
| Brake Tools                    | 9.17 |
| Electrical Tools               | 9.18 |
| Wheel Chocks/Cribbing Material | 9.21 |
| IC Lift Truck Tools            | 9.21 |
| Miscellaneous                  | 9.23 |

Battery Tools  
(See Section 8 - Battery and Charger)

### New Items:

Portable Vacuum - p. 9.05  
Mast Blocking Kits - p. 9.21

Note: 1910.178(q)(5) (1998) of the Occupational Safety and Health Act (OSHA) requires that "All parts of any such industrial truck requiring replacement shall be replaced only by parts equivalent as to safety with those used in the original design."

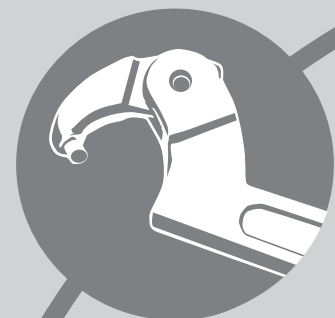

The Crown tool program offers high quality tools selected specifically for technicians to handle most lift truck repairs. Each item offered in the Crown tool kit is individually labeled with the Crown logo and Crown part number.



Part Number - 322999

### Mechanics Tool Kits

Both kits include 212 pieces — all parts on this page and next 2 pages marked with \*

See page 9.05 for personal hand trucks used to carry tool bags.



Part Number - 322996



### 1/4" Drive Socket Set (39 pieces)\*

Part Number - 322000

Includes: Ratchet, Universal Joint, Drive Extensions 1-1/2" and 6", Adaptor 1/4" Female to 3/8" Male, Drive Spinner Handle, 12 Point Shallow Sockets 5/32" thru 9/16", 12 point Deep Sockets 5/32" thru 9/16", 12 Point Shallow Sockets 4mm thru 14mm.

**Note:** Lifetime warranty.



### Screwdriver Set (11 pieces)\*

Part Number - 322150

Includes: Flat Head - 0.018" x 3", 3/16" x 3", 1/4" x 4", 5/16" x 6", 1/8" x 6". Phillips - #0 x 3", #0 x 6", #1 x 3", #2 x 4", #3 x 6". Gasket Scraper 5".

**Note:** Lifetime warranty.



### 3/8" Drive Socket Set (72 pieces)\*

Part Number - 322040

Includes: Ratchet, Universal Joint, Drive Extensions 3" and 5", Adaptor 3/8" Female to 1/4" Male, Adaptor 3/8" Female to 1/2" Male, Adaptor 1/2" Female to 3/8" Male, Drive Spinner Handle, 12 Point Shallow Sockets 5/16" thru 7/8", 12 Point Deep Sockets 5/16" thru 3/4", 12 Point Shallow Sockets 6mm thru 19mm, 12 Point Deep Sockets 6mm thru 19mm, Hex Head Drivers 1/8" thru 3/8", Torx Drivers T10 thru T55, Spark Plug Sockets 5/8" & 13/16".

**Note:** Lifetime warranty.



### Ratcheting Screwdriver

Part Number - 322228

High-impact plastic handle. Heavy-duty 3-way on-off locked ratcheting mechanism. Magnetic, stainless steel shank. Bit storage in handle.

**Note:** Lifetime warranty.



### Pliers Set (4 pieces)\*

Part Number - 322140

Includes: Needle Nose Pliers, Gripping Pliers, Side Cutter, Arc Joint Pliers.

**Note:** Lifetime warranty.



### Combination Wrench Set - SAE (13 pieces)\*

Part Number - 322170

Includes: 1/4", 5/16", 3/8", 7/16", 1/2", 9/16", 5/8", 11/16", 3/4", 13/16", 7/8", 15/16", 1". 15° offset box end knuckle clearance. Made of heat-treated alloy steel for strength exceeding ANSI specifications.

**Note:** Lifetime warranty.



### Hex Wrench Set - L Type, SAE Ball (13 pieces)\*

Part Number - 322113

Includes: 0.050" thru 3/8".

**Note:** Lifetime warranty.



### Combination Wrench Set - Metric (10 pieces)\*

Part Number - 322190

Includes: 10mm thru 19mm. 15° offset box end knuckle clearance. Made of heat-treated alloy steel for strength exceeding ANSI specifications.

**Note:** Lifetime warranty.



### Hex Wrench Set - L Type, Metric Ball (9 pieces)\*

Part Number - 322114

Includes: 1.5mm thru 10mm. Ball end allows better angle of entry for hard to reach areas. Chrome vanadium steel with black oxide finish.

**Note:** Lifetime warranty.



### Angle Wrench Set (6 pieces)\*

Part Number - 322262

Includes: 5/8", 11/16", 3/4", 7/8", 15/16", 1".

**Note:** Lifetime warranty.



### 1/2" Drive Socket Set (16 pieces)\*

Part Number - 322120

Includes: Ratchet, Drive Extension 5", 12 Point Sockets 7/16" thru 1-1/4".

**Note:** Lifetime warranty.



### Pry Bar Set (2 pieces)\*

Part Number - 322115

Includes: 6" and 18". Heat treated alloy steel. Bi-mold rubberized comfort grip.

**Note:** Lifetime warranty.

\*Included in Tote Tool Kit (P.N. 322999) and Backpack Tool Kit (P.N. 322996)





**Roll Pin Punch Set (8 pieces)\***

Part Number - 322210  
Includes: 1/16" thru 5/16".  
**Note:** Lifetime warranty.



**Punch and Chisel Set (8 pieces)\***

Part Number - 322220  
Includes: 1/8" Pin Punch, 3/16" Pin Punch, 1/4" Pin Punch, Taper Punch, 3/8" Center Punch, 5/16" Cold Chisel, 1/2" Cold Chisel, 3/4" Cold Chisel.  
**Note:** Lifetime warranty.



**Ball Peen Hammer\***

Part Number - 322139  
**Note:** Lifetime warranty.



**Tape Measure**

Part Number - 322269

- 25' tape measure
- Automatic blade lock for easy use
- Push button retrieval – quick, one finger operation
- Rubber coated housing for durability and long life
- 1-year warranty



**Locking Pliers - 7"\***

Part Number - 322119  
**Note:** Lifetime warranty.



**Locking Pliers - 10"\***

Part Number - 322118  
**Note:** Lifetime warranty.



**Snap Ring Pliers**

Part Number - 322241  
**Note:** Lifetime warranty.



**Adjustable Wrench - 6"\***

Part Number - 322137  
**Note:** Lifetime warranty.



**Adjustable Wrench - 10"\***

Part Number - 322138  
**Note:** Lifetime warranty.



**3/8" Torque Wrench**

Part Number - 322240  
Interchangeable head. Adjustable torque wrench body. 150 lb. pressure.  
**Note:** Lifetime warranty (excludes calibration).



**Wire Stripper\***

Part Number - 322209  
**Note:** Lifetime warranty.



**Pick Set (4 pieces)\***

Part Number - 322145  
Includes: 45°, Straight, 90°, Awl.  
**Note:** Lifetime warranty.



**Screw Starter - Phillips\***

Part Number - 322219  
**Note:** 90-day warranty.



**Screw Starter - Flathead\***

Part Number - 322221  
**Note:** 90-day warranty.



**Inspection Mirror\***

Part Number - 322222  
Stainless steel shaft pick up tool. Shaft telescopes from 6½" to 33".  
**Note:** 90-day warranty.



**Pick-Up Tool - Magnetic\***

Part Number - 322223  
Stainless steel shaft pick up tool. Shaft telescopes from 6½" to 33". 5 lb. magnetic power for easy picking of heavy parts.  
**Note:** 90-day warranty.

\*Included in Tote Tool Kit (P.N. 322999) and Backpack Tool Kit (P.N. 322996)

## Crown Branded Tool Program



### Slide Rail Socket Holders\*

Part Number - 322225

**Note:** 90-day warranty.



### Tote Tool Bag

Part Number - 322224

**Note:** 1-year warranty.

**Note:** See next page for personal hand trucks used to carry tool bag.



### Crown Technician Backpack

Part Number - 322231

- Made from tear-resistant fabric
- Thermoplastic rubber bottom
- Nylon straps
- 55 lb. loading capacity

### 4" Stainless Steel Magnetic Tray

Part Number - 322302

- Strong holding magnetic tray to secure nuts, bolts and other small parts & fasteners
- 3" PVC coated magnet helps prevent scratching



### 9 7/8" x 5 5/8" Stainless Steel Magnetic Tray

Part Number - 322303

- Strong holding magnetic tray to secure nuts, bolts and other small parts & fasteners
- Two 3" PVC coated magnets help prevent scratching



### 40" Crown Top Tool Box

Part Number - 322229

40" x 20" x 19 7/16" (W x D x H)

### 40" Crown Roll Cabinet

Part Number - 322230

40" x 20" x 38 1/2" (W x D x H)

Eleven drawers provide nearly 25,000 cubic inches of storage space.

- Double ball bearing slides on roll cabinet bottom drawer provides 250 pound capacity
- Lock and roll drawers
- Non-slip drawer
- Gas-assisted lifts on the top chest
- Swivel casters are lockable
- Double wall construction
- Powder coat paint provides scratch resistance for lifetime durability
- Anti-theft locks on both chest and roll cabinet for maximum security



### LED Flashlight

Part Number - 322304

- Pen Light
- Metal clip included



### Counter Stool

Part Number - 322300

- Stool height is 30"
- Stool provides the look of patent leather and is great for the parts counter.

**WARNING:** Reproductive Harm - [www.P65Warnings.ca.gov](http://www.P65Warnings.ca.gov)



### Mini Tool Box

Part Number - 322227

- The Crown three drawer micro tool box measures 8 1/2" x 4 1/2" x 4 1/2"
- Black gloss paint with aluminum trim
- Perfect for storing small parts or office supplies

**Note:** Lifetime warranty.



### Seat Creeper

Part Number - 322306

- 14" seat made with high density foam and heavy-duty vinyl
- (5) 2.5" polypropylene casters increase maneuverability, reduce rolling resistance, and support 360 movement
- Storage drawer
- 20" height
- 300 lb. weight limit



### Counter Stool With Back

Part Number - 322305

- Stool height is 30"
- Stool provides the look of patent leather and is great for the parts counter.

**WARNING:** Reproductive Harm - [www.P65Warnings.ca.gov](http://www.P65Warnings.ca.gov)



**Personal Hand Truck**

Part Number - 322300-001

150 lb. load capacity. Opens and closes in seconds. Extends to 39" tall. Compacts to 25" tall and 2.5" thick. 15" wide aluminum base plate. 5" rubber wheels. No assembly required. Weight: 7.2 lbs.



**Personal Hand Truck**

Part Number - 322300-002

200 lb. load capacity. Opens and closes in seconds. Extends to 39" tall. Compacts to 28.5" tall and 2.5" thick. Extra wide 19.25" aluminum base plate. Rugged 22mm steel frame. 7" rubber wheels. No assembly required. Weight: 10.5 lbs.



**Portable Vacuum - 1 Gallon**

Part Number - 340111

Cord Length: 8 feet. Voltage 12V DC. Crevice nozzle is great for tight spaces. Gulper nozzle is great for large surfaces. Over 20 ft of reach. Plug 12V power cord right into your car.



**Ramp**

Part Number - 340094-005

20" L x 7.25" W x 1" H. Ramp raises Stockpicker power unit skirt high enough for hydraulic jack to fit under the skirt. Truck should then be properly blocked and secured.



**Mast Lubrication Tool Kit**

Part Number - 363163

Helps users grease hard-to-reach areas on mast channels. The 6-12 ft pro-pole provides an extension for the chip brush to grease desired areas. Kit includes: Pro-Pole, Brush Holder, and 3" Straight Edge Chip Brush.

Replacement Brush: P.N. 363163-003



**Bahco F-Clamp**

Part Number - 320076

One fixed and one sliding bracket fitted to a galvanized profiled steel rail along with a plastic covered, ball-swivel foot for easy clamping of odd shapes. 16" overall length. 5" throat depth. 1200 lb. capacity.



360044

**Strap and Hook**

Tuflex polyester SSEN60 x 1'6" round sling with hook floating on the body.

| Part No.   | Description  |
|------------|--|
| 360044     | 5300 lb Capacity Battery Cell Extractor Strap w/Hook         |
| 360044-001 | 3000 lb Capacity Battery Cell Extractor Strap w/Compact Hook |



**Weldex 113 Plier**

Part Number - 306442

Designed for a safe and easy removal of contacts from SB or SBX connectors. Works on either 175 or 350; simply place the thin blade over the spring and press while pulling the cable or contact.



**Hose Pinching Pliers**

Part Number - 360041

Used to close off oil or coolant lines to prevent fluid loss during repairs. Used on C5 trucks.



**Handle and Gate Spanner Tool**

Part Number - 104712

For installation and removal of torsion springs on control handles and platform gates. Used on Pallet trucks, heavy-duty Walkies, Stockpickers, and Tow Tractors. Replacement pins: 061011-013



**Spanner Wrench**

Part Number - 104836

For removal, installation and adjustment of Pallet Truck lift cylinder. Used on PW, PE, PC and PR.



**Molding Insertion Tool**

Part Number - 103792

To ease installation of the two piece safety glass rubber molding. Used on Stockpickers after 10/86 and Turrets. TSB 227



**Shore A Durometer**

Part Number - 390223

Measures wheel and tire Shore A hardness. Test range: 0-100 HA.



**Digital Calipers**

Part Number - 320040-001

Capacity 0-6". Rugged stainless steel body and jaws. 4-way measurement: inside, outside, depth and step. LCD display. Powered by one silver oxide battery 1.55V, type SR44. Suitable for machinists and toolmakers.

⚠️WARNING: Cancer and reproductive harm - [www.P65Warnings.ca.gov](http://www.P65Warnings.ca.gov)



**Fork Wear Calipers**

Part Number - 107330

Used to gauge minimum fork thickness and maximum bore size.



**Chain Wear Scale**

Part Number - 106440

Used to check leaf and roller chain wear used for lift and steering functions.



**Chain Wear Gauge**

Part Number - 306440

Measures chain from 3/8" up to 3" pitch chain. Measures wear in % increments. Allows user to track wear at each inspection. Limits visual errors. Easy to follow instructions included.



**Feeler Gauge Set**

Part Number - 360059

Used to measure gap widths and adjust governor gap. Includes (25) 1/2" x 3" blades in sizes .0015" plus .002" to 0.25" in .001" increments.

**Hydraulic Forklift Jack with Two Stands**

Part Number - 340580

8800 lb capacity. One year warranty.  
Spring loaded lowering knob for safety.

**Seal Kit:** P.N. 300080-001

Includes 2 each index # 8, 12, 17 & 41 and  
1 each # 24, 32, 33, 42, 71 & 72

**(Jack - Only)**

Part Number - 340582

**Pump Assembly:** P.N. 300080-100-01

Index # 100A

Includes index # 9-27, 30-48, 70-74 & 76

**Piston Assembly:** P.N. 300080-101-01

Index # 101A

Includes index # 30-34, 71 & 72

**Capacity Label & Decal Kit:** P.N. 300080-100 (also for 300083)



**Forklift Stands (two)**

Part Number - 340581

7 ton capacity per set of two.

**Replacements:** P.N. 300081-001, pin with lanyard chain;  
P.N. 300081-002, capacity stickers



**Replacement Part Reference for Part Numbers 300083/340582 & 300084/340584**

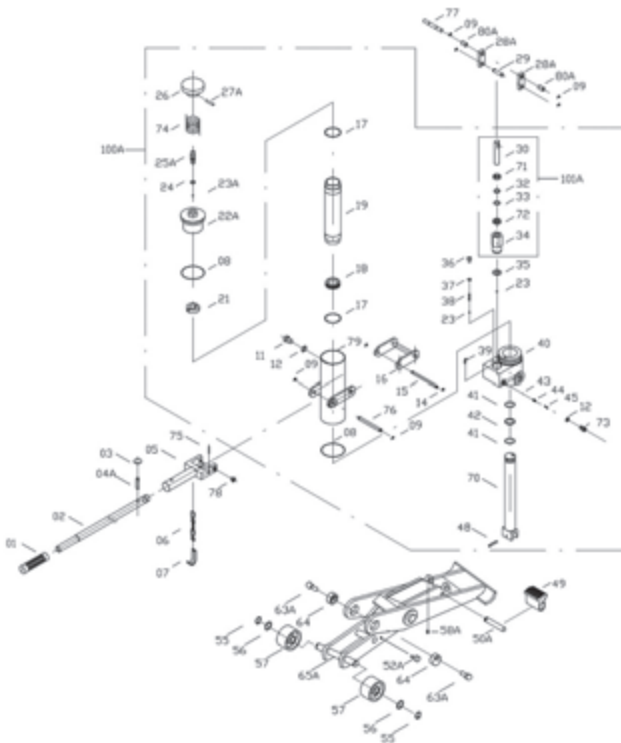

**Hydraulic Forklift (Jack only)**

Part Number - 340584

14,000 lb capacity

**Note:** 1-year warranty

**Seal Kit:** P.N. 300080-001

Includes 2 each index # 8, 12, 17 & 41 and  
1 each # 24, 32, 33, 42, 71 & 72

**Capacity Label:** P.N. 300080-104 (also for 300084)



**Hydraulic Forklift Jack Replacement Parts**

| Part Number   | Description    | Chart Ref. No. | Used On |        |        |        |
|---------------|----------------|----------------|---------|--------|--------|--------|
|               |                |                | 300083  | 300084 | 340582 | 340584 |
| 300080-103    | Handle & grip  | 1 & 2          | x       |        | x      |        |
| 300080-004-01 | Pin            | 4A             |         |        | x      |        |
| 300080-005    | Handle base    | 5              | x       |        | x      |        |
| 300080-007    | Chain & hook   | 6 & 7          | x       |        | x      |        |
| 300084-007    | Chain & hook   | 6 & 7          |         | x      |        | x      |
| 300080-009    | Retaining ring | 9              | x       | x      | x      | x      |
| 300084-014    | Retaining ring | 14             | x       |        | x      |        |
| 300080-015    | Pin            | 15             | x       |        | x      |        |
| 300080-016    | Handle frame   | 16             | x       |        | x      |        |
| 300080-018    | Port ring      | 18             | x       | x      | x      | x      |
| 300080-023-01 | Chrome ball    | 23A            |         |        | x      |        |
| 300080-025-01 | Release rod    | 25A            |         |        | x      |        |
| 300080-026    | Release knob   | 26             | x       | x      | x      | x      |
| 300080-027-01 | Roll pin       | 27A            |         |        | x      |        |
| 300080-028-01 | Link           | 28A            | x       | x      | x      | x      |
| 300080-029    | Pin            | 29             | x       | x      | x      | x      |
| 300080-030    | Plunger        | 30             | x       | x      | x      | x      |
| 300080-034    | Pump           | 34             | x       | x      | x      | x      |
| 300080-035    | Copper washer  | 35             | x       | x      | x      | x      |
| 300080-038    | Spring         | 38             | x       | x      | x      | x      |
| 300080-048    | Pin            | 48             | x       | x      | x      | x      |
| 300080-049    | Saddle         | 49             | x       | x      | x      | x      |
| 300080-050-01 | Saddle pin     | 50A            | x       | x      | x      | x      |
| 300080-052-01 | Screw          | 52A            |         |        | x      |        |
| 300080-055    | Snap ring      | 55             | x       | x      | x      | x      |
| 300080-056    | Washer         | 56             | x       | x      | x      | x      |
| 300080-057    | Wheel          | 57             | x       | x      | x      | x      |
| 300080-058-01 | Set screw      | 58A            |         |        | x      |        |
| 300080-063-01 | Screw          | 63A            | x       | x      | x      | x      |
| 300080-064    | Trunnion       | 64             | x       | x      | x      | x      |
| 300080-065-01 | Frame assembly | 65A            |         |        | x      |        |
| 300080-070    | Piston rod     | 70             | x       |        | x      |        |
| 300084-074    | Spring         | 74             | x       | x      | x      | x      |
| 300080-076    | Pin            | 76             | x       |        | x      |        |
| 300080-077    | Pin            | 77             | x       |        | x      |        |
| 300080-080-01 | Bushing        | 80A            |         |        | x      |        |

TOOLS

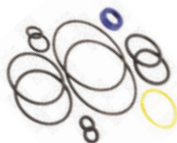

**Hydraulic Jack Seal Kit**

Part Number - 341225-001

Seal kit for Hydraulic Jack P.N. 340580.

**NOT for use with Hydraulic Forklift Jack**  
P.N. 300080/340582 and P.N. 300084/340584  
listed above.



**Tool Retractor**

Part Number

300114

Capacity 1.76-4.4 lbs. (0.8-2.0kg)  
Extended rope length - 5.5 ft.



**Axle Remover**

Part Number - 090705

For single or dual load wheel axle removal on PE, PC, PR, PW trucks. One piece tool.

Replacement rods/set of 2 - P.N. 320066

⚠WARNING: Cancer and reproductive harm - [www.P65Warnings.ca.gov](http://www.P65Warnings.ca.gov)



**Quick Change Load Wheel Installation Tool**

Part Number - 150192 (for 2.88" load wheel)

Part Number - 150193 (for 4.12" load wheel)

Used to install quick change load wheels on Reach trucks.



**Roll Pin Insertion and Extraction Tool**

Part Number - 110567

Removal and installation of load wheel axle roll pin. Used on Stockpickers and RR/RD 3000 and 5000 Series.

⚠WARNING: Cancer and reproductive harm - [www.P65Warnings.ca.gov](http://www.P65Warnings.ca.gov)



**Tire Adapter**

Part Number - 134169

Used to press drive tire on RR/RD 5000 Series trucks. See PIB 05-08-02.

⚠WARNING: Cancer and reproductive harm - [www.P65Warnings.ca.gov](http://www.P65Warnings.ca.gov)

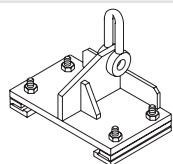

**Auxiliary Mast Lifting Tool**

Part Number - 110571

Facilitates handling auxiliary mast. Used on TS. Refer to platform maintenance of service manual, (section 9.0). One piece tool.



**Steer Bearing Cup Removal Kit**

Part Number - 133884

Used to push cup-holder off of undercarriage dowel pins after bolt removal. Used on all RR5, RM6, RM1, and SP4 models.

Individual Items: Push-Off Bolt (P.N. 060133)



**Gage Shim Assembly**

Part Number - 125535

Gage used to shim Wave masts. Used with Part Numbers 125539 and 133403. See maintenance section for where used.



**Mast Tool**

Part Number - 810705

ESR4000 Mast Tool used to calculate the required roller diameter.



**Gage Shim Assembly**

Part Number - 125539

Gage used to shim Wave masts. Used with Part Numbers 125535 and 133403. See maintenance section for where used.



**Shield / Screen Installation Tool - Tapered Tip**

Part Number - 340020-001

Used to install shields on RR/RD 5000 series, Stockpicker and Turret trucks



**Gage Shim Assembly**

Part Number - 133403

Gage used to shim Wave masts. Used with Part Numbers 125535 and 125539. See maintenance section for where used.



**Shield / Screen Installation Tool - Complete Kit**

Part Number - 340020-002

Used to install shields on RR/RD 5000 series, Stockpicker and Turret trucks.



**Spanner Tool**

Part Number - 100455

For removal, installation and torquing the axle locknuts. Used on RC, SC, Reach, TSP, TS and SP 3000 Series.



**Tool Assembly**

Part Number - 132501

Used for installation of load wheels on stockpickers, WR and reach trucks with an axle diameter of 1.375. This tool aligns the shims and wheels to make it easier to get the axles in.



**Hole Cutting Tool Arbor**

Shank with Pilot Pin - Hougen  
Part Number - MSC98380876

Minimum tool diameter compatibility: 1/16".  
Maximum tool compatibility: 1 1/2".  
Shank diameter: 1/2". No. of flats: 3. Material: Steel.  
Weldon flat: No.

Straight shanks are used for general purpose applications. The shank is smaller than the drill bit diameter. They are used with portable drills and drill presses on ferrous and nonferrous materials.



**Tool Assembly**

Part Number - 132502

Used for installation of load wheels on stockpickers, WR and reach trucks with an axle diameter of .975. This tool aligns the shims and wheels to make it easier to get the axles in.



**Primary Lift Cylinder Retention Tool**

Part Number - 164857

Used on RM 6000 to restrain the primary lift cylinder while raising the 2nd & 3rd mast stages. Used in the removal and installation of the reach assembly.



**3rd Stage Mast Locking Bar Tool**

Part Number - 150796

Used to move mast stops on RM/RMD series mono masts.

## Mechanical Tools

### Bracket Lifting Assembly



Part Number - 149650-001

Bracket bolts to the top of the mast and is used to assist in laying over trucks for shipment. Retains the 2nd & 3rd mast stages from extending while horizontal.

Bracket requires (6) .5" screws (PN 060019-081)

### Hole Cutter



Annular Cutters - Hougén

Part Number - MSC98382922

Diameter: 1<sup>5</sup>/<sub>16</sub>". Cutting depth: 1/2".

Precision ground to produce burr-free holes up to 1/2" deep. Ideal for electrical, piping, conduit, sheet metal & HVAC applications. High-speed steel provides good wear resistance and can be used in general purpose applications for both ferrous and nonferrous materials.

### Torx Bits



Part Number Specifications

|            |          |
|------------|----------|
| 360043     | T25      |
| 360043-002 | T15      |
| 360043-003 | T20      |
| 360043-004 | T20 Plus |

Used to service C-5 Fuel System Electronic Pressure Regulator and Carburetor.

### 1/4" Drive Metric Hex Bit Sockets



Part Number Description

|            |                          |
|------------|--------------------------|
| 360043-007 | 1/4" Drive 2mm Hex Bit   |
| 360043-008 | 1/4" Drive 2.5mm Hex Bit |
| 360043-009 | 1/4" Drive 3mm Hex Bit   |
| 360043-010 | 1/4" Drive 4mm Hex Bit   |
| 360043-011 | 1/4" Drive 5mm Hex Bit   |

Used for servicing V-Force Lithium Ion Batteries with 1/4" Drive Socket Set P.N. 322000.

### Swaging Tool



Part Number - 107416

Crimping stop ferrule on wire rope. Used on Turret and SP 3400 height sensors.

### Hand Swage



Part Number - 090526

Properly crimp compression fittings when repairing or replacing cable. Usage: SP Steering cable, Pallet clamp cable and TS, TSP hose take-up cable. Crimps both shielded and unshielded aircraft control cable. One piece tool, manufacturer's instructions included.



### Air Solvent Gun

Part Number - 065174-001

Use with any solvent.



### Timkin Socket Tools

Part Number - 100253-XXX

For removal, installation and torquing of locknuts. Adapts to 1/2" drive socket.

#### Individual Items:

- 100253-001 - Fits locknut 060043-004
- 100253-002 - Fits locknut 060043-002
- 100253-003 - Fits locknut 060043-003
- 100253-004 - Fits locknut 060043-001
- 100253-005 - Fits locknut 060043-005
- 100253-006 - Fits locknut 060043-006
- 100253-007 - Fits locknut 060043-010
- 100253-008 - Fits locknut 060043-008
- 100253-009 - Fits locknut 135496

### Borescope



Part Number - 360045

Helps technicians view difficult to see places when troubleshooting. Can be used to view inside engine cylinders, radiators, transmissions and drive units as well as many other uses. Features dual-image lenses for straight ahead and 90-degree angle viewing. Digital images are stored to the internal memory or SD card. Quick and easy video recording and playback can be viewed on the 4.3" diagonal screen. Powered by a rechargeable Lithium battery and equipped with a USB port to transfer data.

### Lincoln Grease Fitting Cleaner



Part Number - MSC55374169

Steel, 5852 Coupler, High Pressure Hose, Piston, Safety Shield, Steel Drive Cylinder

⚠️ **WARNING:** Cancer and reproductive harm - [www.P65Warnings.ca.gov](http://www.P65Warnings.ca.gov)

### Nut Adjusting Tool



Part Number - 104958

For removal, installation and torquing of locknuts on the center pivot assembly of reach assemblies. Used on Reach trucks.

⚠️ **WARNING:** Cancer and reproductive harm - [www.P65Warnings.ca.gov](http://www.P65Warnings.ca.gov)

### Close Quarter Prybar



Part Number - 360058

Used to remove RC 5500 & SC 5200 drive unit sub-assemblies from mount plates without damaging the housing.



**Mobil Crimp 4-20 Digital Dial Control**

Part Number Vendor Number

|            |           |
|------------|-----------|
| 320040-420 | 7480-0051 |
|------------|-----------|

Thermoplastic or Rubber Hose. This lightweight, versatile crimping tool is powerful enough to crimp up to 1-1/4" 4 spiral-wire hose. Weighing approximately 57 pounds, this field crimping tool combines the latest crimping technology with old-fashioned toughness and durability. Unit supplied with digital calipers, instructional CD, and manuals.

**Note:** See below for Die Selection Chart.

**Replacement knob:** P.N. 320040-420-07

▲**WARNING:** Cancer and reproductive harm - [www.P65Warnings.ca.gov](http://www.P65Warnings.ca.gov)



320040-420-01



320040-420-02



320040-420-03



320040-420-05



320040-420-06

**Mobil Crimp 4-20 Power Sources**

| Power Sources             | Description  | (PSI) Rating | Weight (lb) | Vendor Number | Part Number   |
|---------------------------|--|--------------|-------------|---------------|---------------|
| Hand Pump                 | No power source needed. Economical, convenient and portable for use anywhere. Make factory-quality assemblies in the field to minimize downtime. | 10,000       | 25.6        | 7481-0006     | 320040-420-01 |
| Shop Air Pump             | Works off standard shop air (90 psi). Economical, convenient and versatile for use wherever 90 psi compressed air is available.                  | 10,000       | 10          | 7481-0002     | 320040-420-02 |
| 12 Volt DC Pump 1/4 HP    | Mobile operation, runs on standard 12 volt car/truck battery or a 12 Volt portable battery pack. Ideal for tough jobs in the field.              | 10,000       | 20.5        | 7481-0037     | 320040-420-03 |
| 115 Volt AC Pump 1/2 HP   | Medium speed. Economical. Recommended for a stationary or mobile application.  | 10,000       | 32          | 7481-0034     | 320040-420-05 |
| 115 Volt AC Pump 1-1/2 HP | High speed. Recommended for stationary applications only.  | 10,000       | 108         | 7481-0035     | 320040-420-06 |

▲**WARNING:** Cancer and reproductive harm - [www.P65Warnings.ca.gov](http://www.P65Warnings.ca.gov)

▲ **Mobile Crimp 4-20 Die Selection Chart**

| Part Number | Die Set | M3K, M2T, G1(C1T) & G2(C2AT) Gates |                                    |
|-------------|---------|------------------------------------|------------------------------------|
|             |         | Rubber Hose Size                   | 3160, 3360, 30CT Synflex Hose Size |
| 320040-422  | MC22    | 3/8"                               | 1/2"                               |
| 320040-431  | MC31    | 1/4"                               | 5/16" and 3/8"                     |
| 320040-423  | MC33    | 1/2"                               | 5/8"                               |
| 320040-424  | MC34    | 5/8"                               |                                    |
| 320040-435  | MC35    | 3/4"                               |                                    |
| 320040-437  | MC37    | 1"                                 |                                    |
| 320040-425  | MC45    |                                    | 1/4" and 3/16"                     |

**Note:** Check crimp diameter and length after each use.

▲**WARNING:** Cancer and reproductive harm - [www.P65Warnings.ca.gov](http://www.P65Warnings.ca.gov)

▼ **PC707 Die Selection Chart**

| Part Number | Die Set | M3K, M2T, G1(C1T) & G2(C2AT) Gates |                                    |
|-------------|---------|------------------------------------|------------------------------------|
|             |         | Rubber Hose Size                   | 3160, 3360, 30CT Synflex Hose Size |
| 320040-731  | 731     | 1/4"                               | 5/16" and 3/8"                     |
| 320040-732  | 732     | 3/8"                               | 1/2"                               |
| 320040-733  | 733     | 1/2"                               | 5/8"                               |
| 320040-734  | 734     | 5/8"                               |                                    |
| 320040-735  | 735     | 3/4"                               |                                    |
| 320040-737  | 737     | 1"                                 |                                    |
| 320040-745  | 745     |                                    | 1/4" and 3/16"                     |

**Note:** Check crimp diameter and length after each use.

▲**WARNING:** Cancer and reproductive harm - [www.P65Warnings.ca.gov](http://www.P65Warnings.ca.gov)



**Power Crimp PC707 Crimper Only**

Part Number Vendor Number

|               |           |
|---------------|-----------|
| 320040-707-01 | 7480-0043 |
|---------------|-----------|

Thermoplastic or Rubber Hose. PC707 is the most precise, yet simplest crimping tool made. It has electronic digital readout to indicate gauge settings. Just push a button and it makes factory-quality hose assemblies in a few seconds. Wired for 115 volts. Includes die backup ring and a notched cone. Weighs 188 lbs. Unit supplied with digital calipers, instructional CD, and manuals.

**Note:** See above right for Die Selection Chart.

▲**WARNING:** Cancer and reproductive harm - [www.P65Warnings.ca.gov](http://www.P65Warnings.ca.gov)



**Power Crimp PC707 Power Source**

Part Number Vendor Number

|               |           |
|---------------|-----------|
| 320040-707-02 | 7481-0023 |
|---------------|-----------|

Pressure Rating Weight (lb)

|           |    |
|-----------|----|
| 4,900 psi | 70 |
|-----------|----|

The flow of two fixed displacement pumps are combined to deliver a high volume of oil at low pressure for fast transversion.

▲**WARNING:** Cancer and reproductive harm - [www.P65Warnings.ca.gov](http://www.P65Warnings.ca.gov)



### Thermoplastic Hose

#### Power Swaging Tool

| Part Number | Vendor Number |
|-------------|---------------|
| 108160      | 4530-009SO    |



### Hose Cutter

Part Number Vendor Number

|        |            |
|--------|------------|
| 108159 | 4523-04006 |
|--------|------------|

Note: For use on 1/8" to 1/2" hose

#### Replacement Blade

Part Number Vendor Number

|        |            |
|--------|------------|
| 320032 | 4523-04003 |
|--------|------------|

Note: For use with P.N. 108159



### Thermoplastic Hose

#### Hand Swaging Tool

| Part Number | Vendor Number |
|-------------|---------------|
| 108161      | 4530-01002    |



### Pusher and Coupling

#### Carrying Case

Part Number Vendor Number

|        |           |
|--------|-----------|
| 320021 | 45J0-0433 |
|--------|-----------|

Note: Only trays included.



### Pusher

| Part Number | Vendor Number | Part Number | Vendor Number |
|-------------|---------------|-------------|---------------|
| 320017      | 4599-FP002    | 108150      | 4599-MP008    |
| 108137      | 4599-FP005    | 108151      | 4599-MP009    |
| 108138      | 4599-FP006    | 108152      | 4599-MP011    |
| 108139      | 4599-FP008    | 320018      | 4599-MP037    |
| 320025      | 4599-FP010    | 320026      | 4599-MP045    |
| 108141      | 4599-FP012    | 320019      | 4599-MP046    |
| 108142      | 4599-FP013    | 320020      | 4599-SP031    |
| 108143      | 4599-FP015    | 108153      | 4599-TP204    |
| 320031      | 4599-FP040    | 108154      | 4599-TP205    |
| 108146      | 4599-MP002    | 108155      | 4599-TP206    |
| 108147      | 4599-MP004    | 108157      | 4599-TP308    |
| 108148      | 4599-MP005    | 108158      | 4599-TP310    |
| 108149      | 4599-MP007    | 320034      | 4599-TP312    |

Note: Used with Hand and Power Swaging Tool, 108160 and 108161.



### Swager and Die Carrying Case

Part Number Vendor Number

|        |            |
|--------|------------|
| 108163 | 45J0-04300 |
|--------|------------|

Note: Tools & Dies not included.



### Cylinder Groove Filler Strip

Part Number - 090779

To aid in removal of pistons by minimizing packing damage during removal. Used on all trucks with piston type (double acting) cylinders utilizing a wire retainer to secure the end cap such as tilt, reach and sideshift cylinders. See TSB 163. One piece (16" long).



### Die

| Part Number | Vendor Number | Part Number | Vendor Number |
|-------------|---------------|-------------|---------------|
| 108130      | 4540-303      | 320049      | 4540-A0800    |
| 108131      | 4540-304      | 108135      | 4540-H06      |
| 108132      | 4540-305      | 108136      | 4540-H08      |
| 108133      | 4540-306      | 320015      | 4540-J06N0    |
| 108134      | 4540-308      | 320016      | 4540-35340    |

Note: Used with Hand and Power Swaging Tool, 108160 and 108161.



### Poly Pack Seal Tools

Part Number - 091240-001 thru 091240-020

Aids in installing seals in poly pak or rod packing cylinders. One tool per dash number. i.e. 091240-004 represents one specific size tool. See TSB 155 and TSB193.

⚠ WARNING: Cancer - [www.P65Warnings.ca.gov](http://www.P65Warnings.ca.gov)



### Cylinder Cap Tool

Part Number - 106438

For removal and installation of cylinder caps used on turret trucks.

⚠ WARNING: Cancer - [www.P65Warnings.ca.gov](http://www.P65Warnings.ca.gov)



### Insertion Depth Marker

| Part Number | Vendor Number |
|-------------|---------------|
| 320033      | 45J0-04603    |





**Spanner Wrench**

Part Number - 104836  
 For removal, installation and adjustment of Pallet Truck lift cylinder. Used on PW, PE, PC and PR.



**Socket Weldment**

Part Number - 143065  
 Cylinder cap tool for removal and installation of cylinder cap (133084) used on TSP 6000.

⚠️ **WARNING:** Cancer and reproductive harm - [www.P65Warnings.ca.gov](http://www.P65Warnings.ca.gov)



**Cap Socket**

Part Number - 117318  
 For removing cap on main lift cylinder on TSTN, TSPTN.

⚠️ **WARNING:** Cancer and reproductive harm - [www.P65Warnings.ca.gov](http://www.P65Warnings.ca.gov)



**Seal and Piston Tool Kit**

Part Number - 127576  
 Used on SC4000 & SC5000 Series steer cylinder. See maintenance section, M6.0. Kit instructions PF16486

**Individual Items:**

Seal Loading Tool (P.N. 127521),  
 Piston Loading Tool (P.N. 127522)

⚠️ **WARNING:** Cancer and reproductive harm - [www.P65Warnings.ca.gov](http://www.P65Warnings.ca.gov)



**Cylinder Seal Tool Kit for Stockpickers**

Part Number - 150081  
 includes 150063 cap socket, 150066 polypack driver, 149323 cap socket, 150067 polypack driver, 091240-005 poly pack sleeve and 091240-009 poly pack sleeve.

**Cylinder Cap Sockets**

| Part No. | Truck Model       | Cylinder  | Tool Kit |
|----------|-------------------|-----------|----------|
| 149322   | RR/RD, FC/C5      | Primary   | 149557   |
| 149323   | RR/RD, FC/C5      | Secondary | 149557   |
| 149322   | RM                |           | 149558   |
| 149495   | SC/RC             | Primary   | 149559   |
| 149494   | SC/RC             | Secondary | 149559   |
| 150063   | SP                | Primary   | 150081   |
| 149323   | SP                | Secondary | 150081   |
| 150063   | SH/SHR            | Primary   | 150082   |
| 150065   | SH/SHR            | Secondary | 150082   |
| 150064   | W/WB/WR           |           | 150083   |
| 149323   | W/WB/WR           |           | 150083   |
| 149322   | W/WB/WR           |           | 150083   |
| 150063   | W/WB/WR           |           | 150083   |
| 150065   | W/WB/WR           |           | 150083   |
| 150456   | TSP 6000/7000 TT  | Primary   | 150469   |
| 150696   | TSP 6000/7000 TT  | Primary   | 150469   |
| 150455   | TSP 6000/7000 TF  |           | 150470   |
| 150457   | TSP 6000/7000 TN  |           | 150471   |
| 150458   | TS, TN, TF        |           | N/A      |
| 149323   | TSP 6000/7000 AUX |           | 150472   |
| 150456   | TS, TSP, TN       |           | 150473   |
| 150063   | TS, TSP, TF       |           | 150474   |
| 150696   | TSP AUX           |           | 150475   |



**Cylinder Packing Tool**

| Part Number | Used on Cylinder Cap |
|-------------|----------------------|
| 804714-001  | 804751               |
| 804714-002  | 804750               |
| 804714-003  | 804749               |
| 804714-005  | 810639               |



**Test Plug Assembly (7/8"-14)**

Part Number - 092177  
 Used to isolate faulty hydraulic component valves. All Crown lift trucks using 7/8"-14 thread hydraulic external component valves, except relief valves. One piece plug with sealing rings.



**Test Plug Assembly (3/4"-16)**

Part Number - 093391  
 Used to isolate faulty hydraulic component valves. Utilizing 3/4"-16 thread hydraulic external component valves, except relief valves. One piece plug with sealing rings.



**Funnel with 100 Mesh Filter**

Part Number - 126098  
 Anti-Splash Funnel with Filter Anti-Splash Ring eliminates spilling of liquid caused by swirling. Greater capacity designed for farm and industry. Comes with one 100 mesh filter. Handy hang-up tab on rim. 9" in diameter.

⚠️ **WARNING:** Cancer and reproductive harm - [www.P65Warnings.ca.gov](http://www.P65Warnings.ca.gov)



**No Drip Funnel**

Part Number - 322232  
 Small and large adapter. Fits 1L, 2L, 4.4L & 5L bottles.



**18" Long Reach Poly Funnel**

Part Number - 300099  
 The 18" funnel works great for filling transmission and other fluid. This funnel can hold up to one quart of fluid and has 4 3/4" top opening and 1/2" bottom spout opening.

## Hydraulic Tools



### Oil Test Kit

Part Number - 3363515 - Tests hydraulic and motor oil. Mail oil samples in for content test results. Comes with container for oil, mailing container and labels.

#### ▼ Test Kit Accessories

### Suction Pump

Part Number - 363515-001



### Tubing, 100 Feet

Part Number - 363515-002



### Accumulator Charging Tool

Part Number - 103623-004

For charging and testing bladder and diaphragm type nitrogen charged accumulators. Accumulators used on Turrets and Stockpickers. Includes: gauge, valve, hose, adapter for nitrogen tank, carrying case and manufacturer's instructions.

#### Individual Items:

- Upper Seal (P.N. 300092)
- Lower Seal (P.N. 300093)
- Hose with Fittings - (P.N. 121422)
- Manual Bleed Valve - (P.N. 300133)



### Hydraulic Pressure Gauge

Part Number - 104812

Used to check hydraulic systems pressure on truck. Used on all Crown lift trucks except tow tractors. Includes: gauge, hose (36") and fitting (1/2" N.P.T.) for TS/TSP model trucks.

All other models of trucks require fitting and connector listed below, not included with gauge.  
 Female fitting (P.N. 123321)  
 Connector (P.N. 064005-003)  
 High pressure gauge (P.N. 304812-001)



### Pressure Gauge

Part Number - 300098

- 4000 PSI single gauge
- 0 to 4000 PSI
- Quick Disconnect (P.N. 123321)
- Used on RST50 & C5



### Coupler

Part Number - 123321

- Used on 300098 and 104812
- Works with nipple part numbers 123887 & 127214



123887



127214

⚠️WARNING: Cancer and reproductive harm - [www.P65Warnings.ca.gov](http://www.P65Warnings.ca.gov)



### 1/2" Thin Wall Socket

Part Number - 104884

For removal and installation of relief valve seat on J.S. Barnes pump and motor assemblies. Used on PW, PE, PC, GPW, SP 3000 Series.



### 1/4"-12 Point Socket

Part Number - 104885

For disassembly and reassembly of J.S. Barnes pumps and Charlyn torque generators.



### Hose Pulling Tool

Part Number - 106465-001 and 106465-002

To couple replacement hose to existing hose for ease of replacement.

Kit instructions - PF8075.

3/4"-16 fitting use P.N. 106465-001

9/16"-18 fitting use P.N. 106465-002



### Spanner Tool

Part Number - 108641

Adjust hose take-up used on TS and TSP.



### Lifting Bracket

Part Number - 151332

Used on RM6000 to lift out secondary lift cylinder ram out of the cylinder without removing the secondary cylinder assembly.



### Velocity Fuse Tool

Part Number - 126400

For removal of velocity fuse in left hand cylinder. Used on RR/RD5000/5200/5700 standard & S class trucks.



### Piston Retainer Tool

Part Number - 816908

Used on PTH 50 Hydraulic Unit (P.N. 816814-001) to keep spring down.



### Pin Tool

Part Number - 163409

Used to prevent the second stage mast from moving during disassembly and reassembling the mast sections. Makes it easier to remove/install the third stage. Used on TSP6000/6500/7000 with TT mast only.

## Drive Tools



### Stud Alignment Tool

Part Number - 125097  
Used on RR and RR 3000 Series trucks, SP 3000 Series and TSP. Used to install Drive Unit Steer Bearing and Stud Kit (P.N. 125096). Kit Instructions - PF6947 and PF6948

#### Individual Items:

Alignment Tool (P.N. 125093),  
Drill Bushing (P.N. 125098),  
Reamer (P.N. 125101)



### Gauge Pivot Stud

Part Number - 128463  
Used to shim drive units on RR/RD 3000 and 5000 Series, SP 3000 Series, TS and TSP. See kit instructions PF16487 & PF16762.



### Drive Wheel Hub Puller

Part Number - 141356  
Used to remove locking nut to replace drive axle seal. Used on RC 5500 & SC 5200. See kit instructions PF16825.



### Special Roll Tap

Part Number - 126105  
Used to tap dowel pins on RR 5000 Series drive unit. See TSB 378.



### Drive Wheel Hub Puller

Part Number - 340079  
Used to remove locking nut to replace drive axle seal. Improved, deluxe model. Makes it easier to remove hub and takes a lot less time than using 141356. Used on RC 5500 & SC 5200.



### Spanner Tool

Part Number - 145194  
Used to remove the threaded adjuster plate from the back side of the RC 5500 & SC 5200 drive unit. It is required for drive unit disassembly.



### Driver Nut Assembly

Part Number - 141357  
Used with gear puller to remove wheel hub. Used on RC 5500 & SC 5200. See kit instructions PF16825.



### Drive Unit Mount Tool

Part Number - 145509  
Used to mount the RC 5500 & SC 5200 drive unit in a vice to hold it in position while working on it.



### Seal Installation Tool

Part Number - 091009  
Aids in installing 2nd reduction gears inner (and outer) oil seal on pre-3000 SP, Pallet, Tow Tractors and Heavy-Duty Walkies. TSB 152, Kit Instructions PF6445 included with part. Includes: threaded sleeve, threaded body, 2 piece handle, 3 locking bolts, depth gauge.

Accessory Items: Gauge (P.N. 091263)



### Brush Retaining Tool

Part Number - 803547-001  
Used with Drive Motor (P.N. 803703).

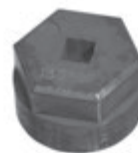

### Bearing Cup Tool

Part Number - 130675  
Used to rebuild drive unit on FC 4000.



### Retaining Ring Pliers

Part Number - 092668  
For removal and installation of large retaining rings. Used on pre-3000 series Stockpickers, Pallet trucks, Tow tractors and heavy-duty Walkies. Tip replacement set (P.N. 106141)



### Drive Coupler

Part Number - 131348  
For drive motor pinion locknut installation of FC 4000.



### Pilot Rods

Part Number - 141316  
Used to align RC5500 traction motor. Need quantity of 4.



### Drive Unit Removal Tool

Part Number - 340332  
Used to remove or install a PE, TR, PR or 30SP drive unit.



### Drive Unit Mount Gauge

Part Number - 126383  
Used to shim drive unit on RR 5000. Kit Instructions - PF6998



**Meter Kit** (P.N. 100696)

**Multimeter Fluke Series 179**

Part Number - 121357

Precise readings of A.C. or D.C. voltage, resistance, low current and frequency. Required for wire guidance systems. Used also for electrical troubleshooting. Includes: 179 Series multimeter, yellow holster, test leads, batteries and instruction manual.

**Kits:** Meter Kit - (P.N.100696), includes Fluke Meter, Carrying Case, Test Leads, and Thermocouple Probe.

**Multimeter Accessory Items**

Used with Part Numbers - 121357 and 121359

**Thermocouple Probe**

Part Number 300091

One piece construction with banana jack. Measurement range: -40 to 500°F (-40 to 260°C) Type K



**Shrouded Test Kit**

Part Number 121421

For use with multimeters that accept shrouded standard diameter, 0.16" (4mm), banana plugs. Manufacturer instructions included. Includes: 2 - #18 AWG (0.75mm<sup>2</sup>) test leads 48" (1.2m) long, one red, one black. Two insulated alligator clips with banana jacks, 5/16" (7.9 mm) jaw opening. Two spade lugs. One safety-grip spring loaded hook style test clip. One test lead pouch.



**Test leads 59"** (1.5 m) long; one red, one black (P.N. 301501)

**Multimeter Fluke Series 87 Series III True RMS**

Part Number - 121359

Precise readings of A.C. or D.C. voltage, resistance, low current and frequency. Required for wire guidance systems. Used also for electrical troubleshooting. Includes: 87 Series multimeter, yellow holster, test leads, batteries and instruction manual. Includes: Thermocouple Probe.

**Accessory Items:** Holster (P.N. 121360), Test Lead Assembly (P.N. 321359)



**Lead Set (Clip-on)**

Part Number 101490

For use with digital (VOM) multimeter on printed circuit boards and close areas where standard tips may short out components. Required on wire guidance P.C. boards such as sensor amplifier boards. Includes: 2 leads with jacks and spring loaded probes (1) red and (1) black.



⚠️ **WARNING:** Cancer and reproductive harm - [www.P65Warnings.ca.gov](http://www.P65Warnings.ca.gov)

**Backprobe Pin Set**

Part Number 320067

Slides onto test lead, narrowing the point of contact for the test lead to be used in narrow situations or hard to reach areas.



**Multimeter (VOM)**

Part Number - 089226

For accurate measurement of A.C. and D.C. voltage, resistance and current. Includes: Simpson Model 260-6XLMP Analog Meter, carrying case, batteries, probes and instructions.

**Individual Items:** Meter only (P.N. 089738), Meter Case (P.N. 089739)



**Probe Set**

Part Number 102973



**Tool Carry Case**

Part Number 128321



**Fluke Meter 3000 Series**

Part Number - 321357

Precise readings of AC or DC voltage, resistance, low current and frequency with this wireless digital multimeter.



**Probe Set**

Part Number 300600

The EAP Kit is designed for electronic systems in which precision is mandatory. Each probe mirrors a back-pinning probe, a piercing probe, and a pin-tip probe. Probes are repairable if they bend or break.



⚠️ **WARNING:** Cancer - [www.P65Warnings.ca.gov](http://www.P65Warnings.ca.gov)

**Fluke 325 True RMS Clamp Meter**

Part Number - 109040

Rugged, reliable True-RMS clamp meter with DC current and frequency measurements. Measures AC and DC voltages to 600 V. Measured AC and DC current to 400 A. Provides True RMS AC voltage and current for accurate measurements on non-linear signals. Measures frequency to 500 Hz. Measures resistance to 40 kilo-ohms with continuity detection.



**Current Clamp**

Part Number 109039

For accurate measurement of AC or DC up to 1000A current draw on battery without inline shunt connection. Includes instructions.



**Field Strength Meter**

Part Number - 112953

To check field strength of guide wire. Label on meter with instructions. See TSB 317.



**Wave 50 Repair Kit (without Handset)**

Part Number - 127674-001

**Wave 50 Repair Kit (with Handset)**

Part Number - 127674-002

Kit Contents Listed (Right)



| Part Number | Description       | Qty. |
|-------------|-------------------|------|
| 120195      | Potentiometer     | 1    |
| 146286      | Key Switch w/keys | 1    |
| 107151-001  | Keys              | 1    |
| 120200-001  | Raise Switch      | 1    |
| 120200-002  | Lower Switch      | 1    |
| 128364-001  | Presence Switch   | 1    |
| 128364-002  | High Speed Switch | 1    |
| 120283-001  | Top Shim .015     | 4    |
| 120283-002  | Top Shim .025     | 4    |
| 120283-003  | Top Shim .035     | 4    |
| 120284-001  | Bottom Shim .015  | 4    |
| 120284-002  | Bottom Shim .025  | 4    |
| 120284-003  | Bottom Shim .035  | 4    |
| 120198-001  | ED Switch         | 2    |
| 062692      | Switch            | 4    |
| 142809      | Display           | 1    |
| 123928      | ED Contact Kit    | 1    |
| 094362-002  | 15 Amp Fuse       | 2    |
| 076924-011  | 40 Amp Fuse       | 2    |
| 084343      | Lift Solenoid     | 2    |
| 113772      | Fuse Holder       | 2    |

| Part Number | Description           | Qty. |
|-------------|-----------------------|------|
| 062595-003  | Raise/Lower Switch    | 1    |
| 062595-005  | Drive/Tow Switch      | 1    |
| 120127      | AC Inlet              | 1    |
| 125253      | Pin Link              | 2    |
| 125254      | Link                  | 4    |
| 060009-092  | Retaining Ring        | 8    |
| 060009-003  | Retaining Ring        | 4    |
| 062536-001  | Terminal              | 24   |
| 062536-002  | Terminal              | 24   |
| 062594-002  | Connector Red         | 2    |
| 062594-003  | Connector Black       | 2    |
| 062535-005  | Connector             | 2    |
| 069188      | Decal                 | 1    |
| 118993      | Extraction Tool       | 1    |
| 117615      | Extraction Tool       | 1    |
| 116858      | Terminal              | 12   |
| 127671      | Carry Case            | 1    |
| 127672      | Parts Case            | 1    |
| 154158      | Handset               | 1    |
|             | (Kit 127674-002 only) |      |

⚠WARNING: Cancer and reproductive harm - [www.P65Warnings.ca.gov](http://www.P65Warnings.ca.gov)



**Sevcon Calibrator**

Part Number - 111930-00S

Dial-in calibration settings, check and monitor inputs from switches and accelerometer potentiometer, read battery voltage, motor voltage, motor current and temperature of controller Mosfet. Used on PE, PC, PR, PE/PC/PR 3000, TWR, TR, TWR/TR 3000, W, WB, WR. Includes interconnecting cord and calibrator.

**Accessory Items:** White Connector (P.N. 803450-018)  
Terminal (P.N. 803450-019)



**Curtis Handset Cord - Molex**

Part Number - 125736

Handset cord for 117617 Curtis calibrator (1207).

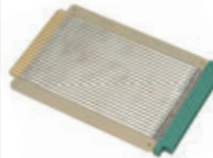

**Extender (Board) Card**

Part Number - 090116

Extension between the logic board receptacle and logic board to permit access for making voltage checks. Used on pre 3000 Series Reach trucks.



**GE Handset**

Part Number - 112209

Dial in calibration settings, retrieve service code numbers. Used on FC/FP, FC 4000, RR/RD/RS, RR/RD/RS 3000, SP 3000, SP 3200, RC 3000, SC 4000, EV100LX and GE SX. Includes: Soft side carrying case, interconnecting cord, handset and manufacturer's instructions.

**Accessory Items:**

Replacement Cord (P.N. 113972)  
Replacement Cord for SC 4000 (P.N. 127085)  
Handset and Both cords (P.N. 127458)



**Unimeter Programmer**

Part Number - 300034

Program settings on unimeter.



**Curtis Calibrator Handset**

Part Number - 154158

Used to input calibration settings, monitor inputs and outputs, diagnostic and troubleshooting aid. Used on GPW, Wave, PE 4000, WE/WS 2000/2300, WP 3000, TR 3600, PC 3600 and GPC 2000 Series. See maintenance manual (M4.2) for instructions. Includes four cords: DB-9 male connector, USB AM & mini USB 5 pin connector, 154199 / Molex style and 154200 / phone style (RJ11).

Curtis handset cords for **prior** Model 1311 handset (P.N. 154158):  
P.N. 130480 - Molex style  
P.N. 130481 - Phone style (RJ11)



**Service Terminal Kit**

Part Number - 118207

Enables monitoring service condition (malfunction) history. Allows performing calibration procedures without opening electronic boxes. TS, TSP, SP 3000, SP 3200, SP 3400 (not SP 3500). Includes: terminal keyboard with two line liquid crystal displays, detachable cables and connectors, foam filled shock resistance carrying case with instruction and operating guide, "How to Use Your Crown Service Terminal" Kit instructions: PF6703.

**Accessory Items:** TS/TSP Cable Assembly (P.N. 102226), SP 3000 Series Cable Assembly (P.N. 118845-00S), Case (P.N. 118954), Service Terminal (P.N. 101528-001), Service Terminal Manual (PF10462)



**Controller Handset**

Part Number - 793548

Handset for Zapi controller. Used on WP 2000 series and ST/SX series. Includes black housing and mounting hardware, white connector and terminals.

**Accessory Item:** White Connector (P.N. 803450-019)

## Diagnostic Tools



### ▲ Connector Rebuild Kit

Part Number - 320055

For controller handset 793548. Includes black housing and mounting hardware, white connector and terminals.



363200-006

### UV Flashlight

Part Number - 363200-006

- Bulb Type - LED 390
- LED 51 Ultraviolet

Part Number - 363200-012

- Bulb Type - 365nm, UV LED
- Ultra High Intensity



### BMID Battery Monitoring Identification Device

Part Number - 396525-BTM

BMID compatible only with Crown V-Force HFM charger. For more details, see page 8.05.



### Cell Trac AC Power Cord

Part Number - 390220-SP



### Coolant/Battery Acid Refractometer

Part Number - 390221

Portable Coolant Refractometer, Coolant/Battery Acid 1.15 to 1.30. Specific Gravity of Battery Acid. Measures the freezing point of coolants and the charge condition of batteries.

⚠ **WARNING:** Cancer and reproductive harm - [www.P65Warnings.ca.gov](http://www.P65Warnings.ca.gov)



### Battery Tester

Part Number - 320070

100 amp battery tester. 300 amp extended jaw. Tests: battery load tests, starters & alternators, battery state of charge.

## Steering Tools



### Hand Swage

Part Number - 090526

Properly crimp compression fitting when repairing or replacing cable. Usage: SP Steering cable, Pallet clamp cable and TS, TSP hose take-up cable. Crimps both shielded and unshielded aircraft control cable. One piece tool, manufacturer's instructions included.



### Steering Wheel Removal Tool

Part Number - 129257

To remove steering wheel on SC 4000/4500/5200 trucks manufactured from September 9, 1999 to present. Kit instructions - PF16549.



### Ball Joint Separator

Part Number - 122532

Used to separate steering ball joint connections. Used on FC/FP and FC 4000.



### Steer Axle Spanner Socket

Part Number - 146107

Used to remove locknut 060043-009. Used on SC 4000/4500/5200, RC 5500 and TSP 6000 steering assemblies.



### Seal and Piston Tool Kit

Part Number - 127576

Used on SC 4000 & SC5000 series steer cylinders. See maintenance section, M6.0. Kit instructions PF16486.

#### Individual Items:

Seal Loading Tool (P.N. 127521),  
Piston Loading Tool (P.N. 127522)

⚠ **WARNING:** Cancer and reproductive harm - [www.P65Warnings.ca.gov](http://www.P65Warnings.ca.gov)



### Power Steering Motor Gear Puller

Part Number - 340403

To remove the gear on the power steering motor on PE4500 series trucks equipped with power steering.

## Brake Tools



### RC Brake Special Nut

Part Number - 114050  
For assembly and disassembly of brake actuation spring. Use on RC with disc brakes.



### RC Brake Adjustment Threaded Tube

Part Number - 114051  
For assembly and disassembly of brake actuation spring. Use on RC with disc brakes.



### Riveter Press

Part Number - 114518  
Used to replace brake pads on SP 3000 Series and SC & SC 4000 trucks. Used with Brake Pad Rivet Tool (P.N. 112397).



### Riveter Base

Part Number - 119343  
Used with 114518 on SP 3000 Series. See maintenance section, (M5.0) for instructions.



### Brake Pad Rivet Tool

Part Number - 112397  
Used to replace brake pads on SP 3000 Series and SC & SC 4000 trucks. Used with Riveter Press (P.N. 114518).



### Brake Shoe Setting Gauge

Part Number - 120988  
For setting brake shoes prior to installing brake drum. Used on FC/FP. Instructions see Service and Maintenance Manual (section M5.0).



### Telescoping Gauge

Part Number - 300089  
Used to check power brake wear on RST-50 & C-5 models with power brake option.



### Brake Release Tool

Part Number - 127373  
Release drive brake. Use on RR 5000 Series trucks, RM/RMD6000/S. See TSB 412. Use with Harness Adapter (P.N. 129694).



### Brake Adapter Harness

Part Number - 129694  
Use with Brake Release Tool (P.N. 127373) on RR 5000 Series trucks. See TSB 412.



### Brake Release Tool

Part Number - 139956-001 / 139956-002  
Release drive brake. Use on SC 4500 and RC 5500 series trucks. See kit instructions PF16819.  
139956-001 - 24 volt  
139956-002 - 36/48 volt



### Piston Removal Tool

Part Number - 126431  
Used on FC/FP with power disc brakes and FC 4000 Series. Removes piston from service brake.



### Brake Pedal Adjustment Kit

Part Number - 138570  
Used to adjust brake linkage on RC 3000. Kit instructions: PF16550



### Retainer Ring Assembly Tool

Part Number - 132417  
Used to disassemble caster and brake assembly on RR 5000S class Series only. Kit instructions: PF16763



### Fluid Evacuator/Brake Bleeder, Pneumatic

Part Number - 320068  
Use for draining engine oil or transmission fluid directly through the dipstick tubes. Includes brake/clutch bleeding kit. 2.3 gallon reservoir capacity.



### Fluid Evacuator, Manual

Part Number - 320069  
Automatic shutoff with quick-drain pour-spout, large stable base, and foot stabilizer. 1.7 gallon reservoir capacity.

**WARNING:** Cancer and reproductive harm - [www.P65Warnings.ca.gov](http://www.P65Warnings.ca.gov)



**Crown Service Laptop**

Part Number - 340099

The Crown Service Laptop is designed to provide software updates from a protected platform. By disabling internet access, the truck software is more secure and shielded from potential viruses.



Includes the following software packages: Multi Series Download Tool, Set Password Utility, SP3400 Tool, RR5000/RR5200 Tool, Wave Updater, V-Force Charger Interface (V-HFM, V-HFE), Module Utility.

Kit includes: Touch Screen Laptop and Laptop Sleeve

*\*Not compatible with V-HFM<sup>3</sup>.*



**Charger Cable 10'**

Part Number - 127490

For use on Wave.



**Static Field Service Kit**

Part Number - 101491

Used to prevent damage to static sensitive components while handling or working with them. Includes: work mat, 15 foot ground cord, adjustable wrist strap, coiled ground cord and manufacturer's instructions.

**Accessory Items:** Coiled Cord Wrist Strap (P.N. 121425)



**PC Download Cable**

Part Number - 126456

Serial cable for software download on RR 5000 Series trucks & SP 3400. See kit instructions PF16547.



**Commutator Dressing Stones**

Part Number - 114888 - 8"x<sup>1</sup>/<sub>4</sub>"x<sup>5</sup>/<sub>16</sub>" Grade Finish (F)

Part Number - 301583 - 6"x<sup>3</sup>/<sub>8</sub>"x<sup>5</sup>/<sub>8</sub>" Grade Finish (F)

Removes film and dirt buildup on motor commutator. Used on motors with limited room in endhead at commutator. 6 pieces in box.



**USB Cables**

Part Number - 300118 (6' cable)

USB A to MINI-B 2.0 cable used to program V-HFM Series High Frequency Chargers.

Part Number - 300118-001 (6' cable)

USB A to Micro-B 2.0 cable used to program V-HFM<sup>3</sup> Series High Frequency Chargers.



**Commutator Brush Stone Set**

Part Number - 101582

For dressing commutators. Used on all Crown brush style motors, lift, steer and accessory. Includes: holder with 2 stones.

**Individual Items:** Holder (P.N. 101580), Green Finish Stones/Qty. 6

(P.N. 101581 - 1"x<sup>3</sup>/<sub>4</sub>"x<sup>5</sup>/<sub>16</sub>"

Yellow Medium Stones/Qty. 6

(P.N. 301581 - 1"x<sup>3</sup>/<sub>4</sub>"x<sup>5</sup>/<sub>16</sub>"



**Isolator Connector**

Part Number - 062785-001

Used on RR 5000 Series when downloading software.



**Trimpot Adjustable Tool**

Part Number - 107369

Use to adjust trimpots. (variable resistors) Use on traction and pump controls with trimpot tune-up adjustments.



**USB to Serial RS232 Adapter Cable**

Part Number - 320058

Used for software downloading on RR5000-RR5200 and SP3400 Traction Modules.



**Lighted Adapter Single Outlet**

Part Number - 340101

Light inside shows power is on. Plug into any 3-conductor outlet or extension cord.



**Software Download Kit**

Part Number - 062915-00S

Used with six pin can interface connections to download software to truck. See kit instructions PF16877.

Used on PE 4500, PR 4500, SC 4500, SC 5200, SC 5300, RC 5500, TSP 6000, FC 4500 and SP 3500.



AMP



**AMP Crimper**

| Part Number | Used on Connector Series | Used on Crown Contacts |
|-------------|--------------------------|------------------------|
| 062726-001  | Mate-N-Lock              | 062036-XXX             |
| 062726-002  | Mini Mate-N-Lock         | 062536-XXX             |
| 062726-003  | Amplimite (dsub)         | 062526-XXX             |
| 062726-004  | Multilock 040            | 062663-XXX             |
| 062726-005  | Multilock 070            | 062663-001             |
| 062726-006  | Ampseal                  | 062721-001             |



**Extraction Tool**

| Part Number | Used on Crown Contacts |
|-------------|------------------------|
| 146583-001  | 062882-001             |
| 146583-002  | 062882-002             |

Removal of contacts. Amp and Tyco style.



**Crimping Tool**

Part Number - 090118  
 For stripping insulation and crimping new terminals on light gauge electrical wire for insertion into Mate-N-Lock connectors (Amp style). Works on 062037 connectors and 062036 contacts. See TSB 173. One piece tool.



**Crimping Tool**

| Part Number | Used on Crown Contacts |
|-------------|------------------------|
| 110965      | 062090-XXX             |

Serial link cable terminal crimping also used on TS, TSP trucks for the terminals in the screw on connectors on the electronics boxes. Instructions not available (Amp style).



**Extraction Tool**

Part Number - 090117  
 Removal of the Mate-N-Lock pin and socket contacts from various Amp connector blocks. See TSB 173 and TSB 175. Includes one piece tool with manufacturer's instructions.



**Extraction Tool**

Part Number - 100380  
 For removal of the Mate-N-Lock pin and socket contacts from various Amp connector blocks. One piece, spring loaded tool with manufacturer's instructions.



**Extraction Tool**

Part Number - 100381  
 For removal of Amp leaf contacts from sensor amplifier P.C. board receptacle. For trucks with wire guidance systems. Contact removal on receptacles. One piece, spring loaded tool with manufacturer's instructions.

AMP



**Extraction/Insertion Tool**

| Part Number | Used on Crown Contacts |
|-------------|------------------------|
| 100521      | 062090-XXX             |

For extracting and inserting Amp male and female contacts on screw on connectors. Used in the electronics boxes on the 40TS/30TSP trucks. Two piece mated plastic tool (blue end - insertion, white end - extraction).



**Extraction Tool**

Part Number - 093493  
 Removal of lead assemblies from printed circuit board connector receptacles. Used on RR, RS, RD and TS trucks, RR, RS and RD circuit selector box, lamp and P.C. Board (Amp style). Used on contacts 062036-XXX. See TSB 175.



**Extraction Tool**

Part Number - 126884  
 For extracting and inserting Amp male and female contacts on screw in connectors.



**Insertion Tool**

Part Number - 126885  
 25 Replacement tips for extraction tool (P.N. 126884).



**Extraction Tool**

Part Number - 100522  
 Removal of contacts from connectors on traction SCR control, EV100 controls (Amp style).



**Extraction Tool**

Part Number - 118993  
 For removing sockets from connector. Used with 062536 terminals. Amp style, miniature rectangular Mate-N-Lock connectors.



**Insertion Tool**

Part Number - 100382  
 For insertion of unstripped electrical leads into MTA 100 connectors to form a reliable connection. One piece tool.



**Insertion Tool**

Part Number - 100524  
 For insertion of unstripped electrical leads into MTA 156 connectors to form a reliable connection. Used on TS/TSP. One piece tool.

## Electrical Tools

### Anderson Power Products



#### Auxiliary Contact Crimp Tool Multi-Die Kit

Part Number - 340084-001

Crimps #6-20AWG SB, SBS, SBE, SBO, Powerpole, Saf-D-Grid, and SPEC Pak Connectors. Includes 3 dies and plastic case.

### Cannon



#### Extraction Tool

Part Number - 100379

For removal of pins from the sensor assembly connector. Used on trucks with Portec wire guidance (Cannon style).



#### Crimping Tool

Part Number Used on Crown Contacts

118504 | 062589, 062588  
Crimp terminals 062589 and 062590, Cannon style.



#### Extraction Tool

Part Number Used on Crown Contacts

118505 | 062589, 062588  
For removing pins on P.N. 062587 and P.N. 062588. Cannon style connectors.

### Deutsch



#### Extraction Tool

Part Number Used on Crown Contacts

062706 | 062704-XXX, 062797-XXX  
Used to remove Deutsch pin and socket contacts from DT and DTM connectors.



#### Crimping Tool

Part Number Used on Crown Contacts

062737-002 | 062704-XXX, 062797-XXX  
For stripping insulation and crimping new terminals on light gauge electrical wire for insertion into Deutsch DT and DTM connectors.

### Molex



#### Extraction Tool

Part Number Used on Crown Contacts

117615 | 116858, 129761-XXX, 803450-XXX  
For removing pins from mini fit connectors. Used on GPW with Curtis 1207 transistor controller and WP 2000 wiring harness handle.



#### Crimping Tool

Part Number Used on Crown Contacts

117636 | 116858, 129761-XXX, 803450-XXX  
For crimping mini fit terminals to wires. Used on GPW with Curtis 1207 transistor controller. Manufacturer's instructions included.

### Molex (continued)

Image Not Available

#### Crimping Tool

Part Number Used on Crown Contacts

360040-001 | 062899-XXX

For crimping terminals to wires. Used on C5 engine harness terminals.



#### Extraction Tool

Part Number Used on Crown Contacts

360040-002 | 062899-XXX

For removing pins from connectors. Used on C5 engine harness connectors.

### Packard



#### Crimping Tool

Part Number Used on Crown Contacts

320051 | 062729-XXX

For crimping Packard pin and sleeve terminals. Crimps terminals and seals in a single cycle.



#### Extraction Tool

Part Number Used on Crown Contacts

320053 | 062729-XXX

For removing pins from Packard connectors.



#### Crimping Tool

Part Number Used on Crown Contacts

320052 | 062896-XXX

For crimping Packard Metri-pack 150 & 280 sealed 20-14 guage terminals. Core & insulation wings are crimped in a separate motion.



#### Extraction Tool

Part Number Used on Crown Contacts

320054 | 062896-XXX

For removing terminals in Packard Metri-pack 150 & 280 connectors.



#### SB Extraction Tool

Part Number Amps

340089-001 | 175  
340089-002 | 350

### Weidmuller



#### Crimping Tool

Part Number Used on Crown Contacts

803452-003 | 803452-005, 803452-006, 803452-008

For stripping insulation and crimping Weidmuller terminals.

⚠ WARNING: Cancer and reproductive harm - [www.P65Warnings.ca.gov](http://www.P65Warnings.ca.gov)

## Wheel Chocks

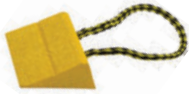

**Wheel Chock - Small**  
Part Number - 340094-001  
3" x 2.5" x 3"



**Blocking Outrigger - Large**  
Part Number - 340094-002  
5.8" x 3.6" x 9.5"



**Double Wheel Chock**  
Part Number - 340094-006  
9.5" x 5.9" x 3.6"



**Wheel Chock**  
Part Number - 340094-004  
3" x 4.9" x 2.6"



**Wheel Chock**  
Part Number - 340094-003  
5" x 4" x 8"

## Cribbing Material



**Block**  
Part Number - 061141  
3.5" x 2.5" x 6"



**Block Pyramid Surfaced**  
Part Number - 061144  
6" x 7" x 10"



**Block Composite**  
Part Number - 061142-001  
RD. 3.5" x 2.5" x 9"  
Part Number - 061142-002  
RR. 3.5" x 2.5" x 13"



**Block Composite**  
Part Number - 061143-001  
Short. 4" x 4" x 22"  
Part Number - 061143-002  
Long. 4" x 4" x 48"



**Mast Blocking Kits**

Blocks are rated with a working load limit. Resistant to mold, mildew and insects. Splinter resistant. Does not absorb most chemicals. Easily washable. Does not rot like traditional wood. Always refer to the Control of Hazardous Energy section in the Crown service manual for instructions on blocking the mast and fork carriage.



| Part Number | Description                          | WLL (lbs) | Kit Qty |
|-------------|--------------------------------------|-----------|---------|
| 340094-008  | RM Blocking Kit                      |           |         |
|             | Block with cut out 1.5 x 4.75 x 44.5 | 7,800     | 2       |
|             | Block 1.5 x 4.75 x 20.5              | 17,100    | 2       |
|             | Block 1.5 x 4.75 x 11                | 13,500    | 1       |
|             | Block 3 x 3 x 30                     | 17,100    | 1       |



| Part Number | Description                      | WLL (lbs) | Kit Qty |
|-------------|----------------------------------|-----------|---------|
| 340094-009  | TSP Blocking Kit                 |           |         |
|             | Block with cut out 3 x 3.75 x 48 | 15,600    | 2       |
|             | Block 3 x 3.75 x 14              | 21,300    | 2       |

**Additional Recommended Item:** F-Clamp Bahco 16" (P.N. 320076)

## IC Lift Truck Tools Continued ▶

**Hamech Tools**



**Diagnostic Tool**  
Part Number - 935958  
For the Hamech V34 units with the Juniper operating system. The technician can not only read Trouble Codes, but also view real-time streams of Engine Sensor Data.  
For PSI Diagnostic Tool, see P.N. 101529-00207  
For PSI Diagnostic Plug, see P.N. 33001197

**C-5 Brake Tools**

Image Not Available

**SAHR Cap Tool**  
Part Number - 360057  
Used for C-5 power brake equipped lift trucks to remove and install brake SAHR cap.

**C-5 Engine Tools**



**Compression Gauge and Hose Assembly**

Part Number - 145739

High Quality Snap on Engine Compression Gauge for measuring cylinder compression on internal combustion engines.

**Accessory Items:** Compression Test Assembly (P.N. 145006)  
Adapter to be used with the 145739 Engine Compression Gauge. This is required for measuring cylinder compression on C-5, RST-50 and RP-50 internal combustion forklifts.

**Replacement part:** Schrader valve/check valve - P.N. 145740



**4024 Electronic Data Link Kit**

Part Number - 164229

Used for downloading RST-50 & C-5 software into truck.

**C-5 Transaxle Tools**



**Transaxle Socket Tool**

Part Number - 360055

C-5 transaxle dual purpose socket for C-5 transaxle rebuild. Also, works with Pinion Shaft Socket 360060 to loosen and tighten pinion shaft nut. Long socket extension used with a press to compress clutch shaft friction plate spring for friction plate removal.



**Pinion Shaft Nut Socket**

Part Number - 360060

Used with transaxle socket tool 360055 as a drive/extension to loosen and tighten pinion shaft nut.



**Trans Puller Set With Bag**

Part Number - 360056

Used for C-5 & RST transaxle rebuilds to remove internal bearings.

**C-G Tools**



**PSI Diagnostic Tool**

Part Number - 101529-00207

For both Crown C-G and Hamech units. Using the E-Controls GCP Diagnostic Scan Tool (DST), the Technician can not only read Trouble Codes, but also view real-time streams of Engine Sensor Data.



**PSI Diagnostic Plug**

Part Number - 33001197

For both Crown C-G and Hamech units. Allows you to retrieve Trouble Codes without using the GCP Diagnostic Scan Tool.

**C-5 Transaxle Tools**



**Spanner Wrench**

Part Number - 360046

Used to assemble and tighten C-5 differential carrier bearing adjuster ring nut.



**Axle Bearing Tool**

Part Number - 145012

Used to assist in removing drive axle hubs. Fits into end of axle on RST-50 and C-5 models to give puller tool a platform to press against.



**Bushing Installation Tool**

Part Number - 144931

Used to install drive axle bushings (145321) on RST-50 and C-5 models.



**Axle Hub Alignment Tool**

Part Number - 143129

Used to install drive axle hub on RST-50 and C-5 models. Helps align hub and protects hub seal when installing drive hubs. Use with 143130 axle hub alignment tool.



**Axle Hub Bearing Driver Tool**

Part Number - 143130

Used to install drive axle hub on RST-50 and C-5 models. Use with 143129 axle hub alignment tool.



**Hub Seal Installation Tool**

Part Number - 065208

Used to install Drive hub inner seals on RST-50 and C-5 models. Helps to position seal at the correct depth and prevents seal damage.

⚠ **WARNING:** Cancer and reproductive harm - [www.P65Warnings.ca.gov](http://www.P65Warnings.ca.gov)



**Transmission Pressure Test Kit**

Part Number - 360042

Used for checking C-5/RST transmission pressures during troubleshooting.



**Pinion Shaft Socket**

Part Number - 360047

Used to set pinion shaft bearing per load on C-5 transaxle.

## IC Lift Truck Tools

### C-D Tools



#### Diesel Diagnostic Tool

Part Number - 860104-01045

This Diagnostic tool consists of several functions to verify engine condition, fault code detecting and resolving, test, ECU reprogramming. You can also find present or historic codes with troubleshooting guide for resolving these. Enables to check or logging sensors and service data values.



#### Diesel Refractometer Kit

Part Number - 390224

In order to properly verify and check Diesel Exhaust Fluid (DEF) a special tester (Refractometer) is required. The refractometer is used to measure the quality or specific gravity (31.8% - 33.2%) of the DEF.

### C-5 Engine Tools



#### Wrench Fan Bearing Bushing

Part Number - 360054

Used to tighten or loosen engine fan on RST-50 & C-5 models without ODC.



#### Hydraulic Lifter Bleed Down Tool

Part Number - 141920

Used to disperse oil from the lifters on C-5 when replacing the cylinder head.

A 144998 flywheel timing lock pin is also recommended.



## Miscellaneous



#### Grease Gun, Lever Handle 10,000 PSI

Part Number - 323000

Rugged pump with cast iron head for strength and durability. Heavy-duty plated steel lever handle. "Flip-Over" follower allows for a superior seal. For use with 16 ounce bulk or 14.5 ounce cartridge.

#### Accessories:

18" Whip Hose Extension - P.N. 323000-100

Hydraulic Coupler - P.N. 323000-101

*Note: Both parts can be added to 323000 to make a flex hose.*



323000-100



323000-101



#### Grease Gun, Lever Handle 10,000 PSI

Part Number - 323000-001

Flex hose nozzle extension. Rugged pump with cast iron head for strength and durability. Heavy duty plated steel lever handle. Barrel with flip follower allows for a superior seal. For use with 16 ounce bulk or 14.5 ounce cartridge.



#### Grease Gun, Pistol Grip Handle 3,500 PSI

Part Number - 323001

Flex-hose nozzle extension. Includes die-cast aluminum pump head, hose and follower.



#### Adhesive Eraser

| Part Number | Description              |
|-------------|--------------------------|
| 380030-191  | 3M Adhesive Eraser Wheel |

Easy to use tool for removing adhesives and films from painted surfaces. Will not scratch or damage acrylic enamel or urethane paint. For use with electric drill. Eraser wheel dimensions: 4" x 5/8". Attachment: 3/8".

### 3M Scotch-Brite Surface Conditioning Discs, Roloc



323002



323004



323005



323003

| Part No. | Diam. | Color  | Grit   | Sales Unit |
|----------|-------|--------|--------|------------|
| 323002   | 2"    | Brown  | Coarse | 25/box     |
| 323003   | 2"    | Maroon | Medium | 25/box     |
| 323004   | 3"    | Brown  | Coarse | 25/box     |
| 323005   | 3"    | Maroon | Medium | 25/box     |

For cleaning and finishing on all metals for removal of light rust, oxides and coatings. Great for decorative finishes, cleaning applications and deburring. Aluminum Oxide grit.

### 3M Corps Roloc Sanding Discs



| Part No. | Diam. | Color | Grit | Sales Unit |
|----------|-------|-------|------|------------|
| 323008   | 2"    | Brown | 60   | 50/box     |

Tough abrasive disc for a fast cutting, long lasting abrasive. Provides superior performance in high pressure applications. Excellent flexibility with a durable backing allows the disc to be used in hard to reach areas. Max RPM 25,000.

### 3M Corps Roloc Sanding Discs



323006



323007

| Part No. | Diam. | Color | Grit | Sales Unit |
|----------|-------|-------|------|------------|
| 323006   | 2"    | Brown | 50   | 50/box     |
| 323007   | 3"    | Green | 36   | 25/box     |

Generally used to remove paint, rust and welds in metal grinding applications. Aluminum Oxide grit.

# Planned Maintenance and Tune-Up Kits for IC Forklifts



**We stock the parts you need most**



**PLANNED MAINTENANCE KITS**



**TUNE-UP KITS**

A time-saving solution for completing important routine maintenance. Kits help streamline the ordering and inventory process by combining all of the necessary components under a single part number. Kits are available for IC forklifts and engine types from a wide variety of manufacturers.

**See IC Truck Components Section**

## Section 10

# Hydraulic Components

### Contents

|   |       |
|---|-------|
| Thermoplastic Hose                              | 10.02 |
| Steel Wire Braid Hose                           | 10.02 |
| Thermoplastic Hose Couplings                    | 10.03 |
| Thermoplastic Hose Couplings<br>Cross Reference | 10.05 |
| Rubber Hose                                     | 10.05 |
| Rubber Hose Couplings                           | 10.06 |

**Note: See Section 9, Tools, for a list of hydraulic tools, including power crimps, dies, pushers, hose cutters, and swager tools.**

Note: 1910.178(q)(5) (1998) of the Occupational Safety and Health Act (OSHA) requires that "All parts of any such industrial truck requiring replacement shall be replaced only by parts equivalent as to safety with those used in the original design."



## Thermoplastic Hose

### Medium Pressure (2000 - 3000 psi/138 - 207 bar)

| I.D. | Vendor Number | Maximum Working Pressure | Bulk Part Numbers | 250 ft roll |
|------|---------------|--------------------------|-------------------|-------------|
| 3/16 | 3160-03       | 3000                     | 064101-062        | 064101-067  |
| 1/4  | 3160-04       | 3000                     | 064101-063        | 064101-068  |
| 5/16 | 3160-05       | 2500                     | 064101-064        | 064101-069  |
| 3/8  | 3160-06       | 2250                     | 064101-065        | 064101-070  |
| 1/2  | 3160-08       | 2000                     | 064101-066        |             |

### High Pressure (2000-5000 psi/138-354 bar)

| I.D. | Vendor Number | Maximum Working Pressure | Bulk Part Numbers | 250 ft roll |
|------|---------------|--------------------------|-------------------|-------------|
| 3/8  | 3R80-06       | 4000                     |                   | 320046      |

### Constant Pressure (3000 psi/207 bar)

| I.D. | Vendor Number | Maximum Working Pressure | Bulk Part Numbers | 250 ft roll |
|------|---------------|--------------------------|-------------------|-------------|
| 5/8  | 3360-10       | 3000                     |                   | 320024      |

### Constant Pressure (3000 psi/276 bar)

| I.D. | Vendor Number | Maximum Working Pressure | Bulk Part Numbers | 250 ft roll |
|------|---------------|--------------------------|-------------------|-------------|
| 1/4  | 30CT-04       | 3000                     | 320045-005-01     | 320045-005  |
| 5/16 | 30CT-05       | 3000                     | 320045-004-01     | 320045-004  |
| 3/8  | 30CT-06       | 3000                     | 320045-001-01     | 320045-001  |
| 1/2  | 30CT-08       | 3000                     | 320045-003-01     | 320045-003  |
| 5/8  | 30CT-10       | 3000                     | 320045-002-01     | 320045-002  |

### Thermoplastic Hose Cross Reference

| Part Number (250 ft Roll) | Pressure Type | Furon*  | Dayco Parker | Aeroquip | Eastman |
|---------------------------|---------------|---------|--------------|----------|---------|
| 064101-067                | Medium        | 3160-03 | 55LT-3       | FC372-03 | NA      |
| 064101-068                | Medium        | 3160-04 | 55LT-4       | FC372-04 | C204    |
| 064101-069                | Medium        | 3160-05 | 55LT-5       | FC372-05 | C205    |
| 064101-070                | Medium        | 3160-06 | 55LT-6       | FC372-06 | C206    |
| 064101-067                | Medium        | 3160-03 | 540N-3       | NA       | NA      |
| 064101-068                | Medium        | 3160-04 | 540N-4       | NA       | NA      |
| 064101-069                | Medium        | 3160-05 | 540N-5       | NA       | NA      |
| 064101-070                | Medium        | 3160-06 | 540N-6       | NA       | NA      |
| 064101-067                | Medium        | 3160-03 | 550H-3       | NA       | NA      |
| 064101-068                | Medium        | 3160-04 | 550H-4       | NA       | NA      |
| 064101-069                | Medium        | 3160-05 | 550H-5       | NA       | NA      |
| 064101-070                | Medium        | 3160-06 | 550H-6       | NA       | NA      |
| 320024                    | **            | 3360-10 | 53LT-10      | NA       | NA      |
| 320046                    | High          | 3R80-06 | 520N-6       | NA       | NA      |
| 320045-001                | Constant      | 30CT-06 | 55LT-06      | 30CT-06  | NA      |
| 320045-002                | Constant      | 30CT-10 | 55LT-10      | 30CT-10  | NA      |
| 320045-003                | Constant      | 30CT-08 | 55LT-08      | 30CT-08  | NA      |
| 320024                    | **            | 3360-10 | 53DM-10      | NA       | NA      |

\*Note: Although all Furon hoses meet or exceed the pressure ratings of the competitors equivalent hose, not all are made from the same materials or construction nor were designed for the exact same applications.

\*\* Note: 3,000 psi constant

## Steel Wire Braid Hose\*

### Medium Pressure\*\* (2250 - 3500 psi/155 - 241 bar)

| I.D. | Vendor Number | Maximum Working Pressure | Bulk Part Numbers | 250 ft roll |
|------|---------------|--------------------------|-------------------|-------------|
| 3/8  | 3580-06       | 3250                     | 320039-006-01     | 320039-006  |
| 1/2  | 3580-08       | 3000                     |                   | 320039-008  |

\*Note: Do not use 3580 hose in over sheave (pulley) applications.

\*\*Note: Steel wire reinforced medium pressure hose (meets or exceeds 100R1 & 100R7 performance specs).

### Steel Wire Braid Hose Cross Reference

| Part Number (250 ft Roll) | Pressure Type** | Furon*  | Dayco Parker |
|---------------------------|-----------------|---------|--------------|
| 320039-006 ***            | Medium          | 3580-06 | 560-6        |
| 320039-008                | Medium          | 3580-08 | 560-8        |

\*Note: Although all Furon hoses meet or exceed the pressure ratings of the competitors equivalent hose, not all are made from the same materials or construction nor were designed for the exact same applications. Do not use 3580 hose in over sheave (pulley) applications.

\*\*Note: Steel wire reinforced medium pressure hose (meets or exceeds 100R1 & 100R7 performance specs).

\*\*\*Note: Dayco Parker 560-6 has 4,000 PSI, 16,000 burst pressure and Furon 3580-06 has 3,200 PSI, 13,000 burst pressure.

**Note:** See Section 9, Tools, for a list of hydraulic tools, including power crimps, dies, pushers, hose cutters, and swager tools.





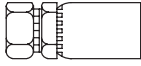

**30° Inverted Flare NPSM**

| Hose I.D. | Dash Size | Thread | Current Vendor Number | Former Vendor Number | Part Number | Fitting Hose Depth |
|-----------|-----------|--------|-----------------------|----------------------|-------------|--------------------|
| 1/4       | -4        | 1/4-18 | 90304-042400          | 3903-04244           | 320006      | 1-5/16             |

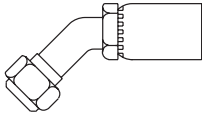

**45° Bent Tube Female Swivel JIC 37 degree**

| Hose I.D. | Dash Size | Thread  | Current Vendor Number | Former Vendor Number | Part Number | Fitting Hose Depth |
|-----------|-----------|---------|-----------------------|----------------------|-------------|--------------------|
| 5/16      | -6        | 9/16-18 | 90305-065540          | 3903-05606           | 064227-001  | 1-5/8              |
| 3/8       | -6        | 9/16-18 | 90306-065540          | 3903-06606           | 320027-002  | 1-11/16            |
| 3/8       | -8        | 3/4-16  | 90308-085540          | 3903-06608           | 320027      | 1-7/8              |
| 1/2       | -10       | 7/8-14  | 90308-105540          | 3903-08610           | 320027-003  | 1-5/16             |

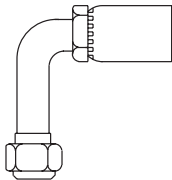

**90° Long Bent Tube Female Swivel, JIC 37 degree**

| Hose I.D. | Dash Size | Thread  | Current Vendor Number | Former Vendor Number | Part Number | Fitting Hose Depth |
|-----------|-----------|---------|-----------------------|----------------------|-------------|--------------------|
| 1/4       | -4        | 7/16-20 | 90304-0455L0          | 3903-04844           | 320002      | 1-1/4              |
| 5/16      | -6        | 9/16-18 | 90305-0655L0          | 3903-05846           | 064226-001  | 1-5/16             |
| 3/8       | -6        | 9/16-18 | 90306-0655L0          | 3903-06846           | 064226-007  | 1-3/8              |
| 3/8       | -8        | 3/4-16  | 90306-0855L0          | 3903-06848           | 064226-002  | 1-1/2              |
| 1/2       | -8        | 3/4-16  | 90308-0855L0          | 3903-08848           | 320002-001  | 1-7/16             |
| 1/2       | -10       | 7/8-14  | 90308-1055L0          | 3903-08850           | 320002-002  | 1-9/16             |

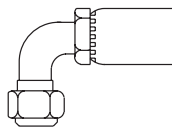

**90° Short Bent Tube Female Swivel, JIC 37 degree**

| Hose I.D. | Dash Size | Thread  | Current Vendor Number | Former Vendor Number | Part Number | Fitting Hose Depth |
|-----------|-----------|---------|-----------------------|----------------------|-------------|--------------------|
| 1/4       | -4        | 7/16-20 | 90304-0455S0          | 3903-04644           | 064226-003  | 1-1/4              |
| 1/4       | -6        | 7/16-18 | 90304-0655S0          | 3903-04646           | 320001      | 1-3/8              |
| 5/16      | -6        | 9/16-18 | 90305-0655S0          | 3903-05646           | 064226-005  | 1-5/16             |
| 3/8       | -6        | 9/16-18 | 90306-0655S0          | 3903-06646           | 064226-008  | 1-3/8              |
| 3/8       | -8        | 3/4-16  | 90306-0855S0          | 3903-06648           | 064226-006  | 1-1/2              |
| 1/2       | -10       | 7/8-14  | 90308-1055S0          | 3903-08650           | 320001-002  | 1-9/16             |
| 1/2       | -8        | 3/4-16  | 90308-0855S0          | 3903-08648           | 320001-001  | 1-7/16             |

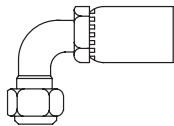

**90° Elbow Female Swivel, O-Ring Face Seal**

| Hose I.D. | Dash Size | Thread   | Current Vendor Number | Former Vendor Number | Part Number | Fitting Hose Depth |
|-----------|-----------|----------|-----------------------|----------------------|-------------|--------------------|
| 3/8       | -6        | 11/16-16 | 90306-0640S0          | 3903-06476           | 320009      | 1-7/16             |
| 1/2       | -8        | 13/16-16 | 90H08-0840S0          | 3903-08478           | 320009-001  | 1-1/2              |

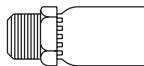

**Male Rigid**

| Hose ID | Pipe Size | Current Vendor Number | Former Vendor Number | Part Number | Fitting Hose Depth |
|---------|-----------|-----------------------|----------------------|-------------|--------------------|
| 1/4     | 1/4       | 90304-041000          | 3903-04104           | 320004      | 1-3/16             |
| 1/4     | 3/8       | 90304-061000          | 3903-04106           | 320005      | 1-5/16             |
| 5/16    | 1/4       | 90305-041000          | 3903-05104           | 064116-001  | 1-3/16             |
| 5/16    | 3/8       | 90305-061000          | 3903-05106           | 064116-003  | 1-1/4              |

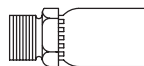

**Male O-Ring Straight Thread**

| Hose I.D. | Dash Size | Thread  | Current Vendor Number | Former Vendor Number | Part Number | Fitting Hose Depth |
|-----------|-----------|---------|-----------------------|----------------------|-------------|--------------------|
| 3/16      | -4        | 7/16-20 | 90303-04D000          | 3903-03D04           | 064224-002  | 1-1/16             |
| 1/4       | -5        | 1/2-20  | 90304-05D000          | 3903-04D05           | 320007      | 1-1/32             |
| 3/8       | -6        | 9/16-18 | 90306-06D000          | 3903-06D06           | 320007-001  | 1-5/32             |

\*Note: See Section 9, Tools, for pusher and die Crown part numbers.

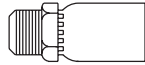

### JIC 37° Male Rigid

| Hose I.D. | Dash Size | Thread  | Current Vendor Number | Former Vendor Number | Part Number | Fitting Hose Depth |
|-----------|-----------|---------|-----------------------|----------------------|-------------|--------------------|
| 3/16      | -4        | 7/16-20 | 90303-045000          | 3903-03504           | 064113-005  | 1-1/4              |
| 1/4       | -4        | 7/16-20 | 90304-045000          | 3903-04504           | 064113-001  | 1-1/4              |
| 1/4       | -6        | 9/16-18 | 90304-065000          | 3903-04506           | 320044      | 1-3/16             |
| 5/16      | -6        | 9/16-18 | 90305-065000          | 3903-05506           | 064113-010  | 1-5/16             |
| 3/8       | -6        | 9/16-18 | 90306-065000          | 3903-06506           | 064113-009  | 1-5/16             |
| 3/8       | -8        | 3/4-16  | 90306-085000          | 3903-06508           | 064113-002  | 1-7/16             |
| 1/2       | -10       | 7/8-14  | 90308-105000          | 3903-08510           | 320044-002  | 1-9/16             |
| 1/2       | -8        | 3/4-16  | 90308-085000          | 3903-08508           | 320044-001  | 1-3/8              |

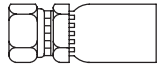

### SAE 45° Female Swivel

| Hose I.D. | Dash Size | Thread  | Current Vendor Number | Former Vendor Number | Part Number | Fitting Hose Depth |
|-----------|-----------|---------|-----------------------|----------------------|-------------|--------------------|
| 3/16      | -4        | 7/16-20 | 90304-045400          | 3903-03544           | 064112-011  | 1-3/8              |
| 1/4       | -5        | 1/2-20  | 90304-055400          | 3903-04545           | 064225-002  | 1-7/16             |
| 5/16      | -5        | 1/2-20  | 90305-055400          | 3903-05545           | 320047      | 1-3/8              |
| 3/8       | -8        | 3/4-16  | 90306-085400          | 3903-06548           | 064112-004  | 1-9/16             |
| 1/2       | -8        | 3/4-16  | 90308-085400          | 3903-08548           | 064112-014  | 1-5/8              |
| 1/2       | -10       | 7/8-14  | 90308-105400          | 3903-08550           | 320013-002  | 1-5/8              |

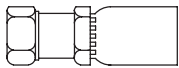

### Straight with Female Swivel O-Ring Face Seal

| Hose I.D. | Dash Size | Thread    | Current Vendor Number | Former Vendor Number | Part Number | Fitting Hose Depth |
|-----------|-----------|-----------|-----------------------|----------------------|-------------|--------------------|
| 1/4       | -4        | 9/16-18   | 90304-044000          | 3903-04404           | 320000      | 1.520              |
| 5/16      | -5        | 11/16-16  | 90305-064000          | 3903-05406           | 320003      | 1.545              |
| 3/8       | -6        | 11/16-16  | 90306-064000          | 3903-06406           | 064277-016  | 1.440              |
| 3/8       | -6        | 13/16-16  | 90306-084000          | 3903-06408           | 064277-017  | 1.788              |
| 1/2       | -8        | 13/16-16  | 90308-084000          | 3903-08408           | 320003-001  | 1.565              |
| 5/8       | -10       | 1-14      | 90H10-104000          | 390H-10410           | 064277-010  | 2.060              |
| 5/8       | -10       | 1-14      | 90N10-10420T          | 390N-10410-001       | 064277-018  | 1.625              |
| 5/8       | -10       | 1 3/16-12 | 90N10-124200          | 390N-10412           | 320003-002  | 1.560              |

Note: 390H fittings use on 3360-10 hose, 390N fittings use on 30CT-10 hose.



### Female Swivel O-Ring Face Seal 45° Bend

| Hose I.D. | Dash Size | Thread  | Current Vendor Number | Former Vendor Number | Part Number | Fitting Hose Depth |
|-----------|-----------|---------|-----------------------|----------------------|-------------|--------------------|
| 1/4       | -4        | 9/16-18 | 90304-044040          | 3903-04444           | 320057      | 1.500              |

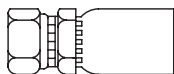

### JIC 37° Female Swivel

| Hose I.D. | Dash Size | Thread    | Current Vendor Number | Former Vendor Number | Part Number | Fitting Hose Depth |
|-----------|-----------|-----------|-----------------------|----------------------|-------------|--------------------|
| 3/16      | -4        | 7/16-20   | 90303-045400          | 3903-03544           | 064112-011  | 1-3/8              |
| 1/4       | -4        | 7/16-20   | 90304-045400          | 3903-04544           | 064112-001  | 1-7/16             |
| 1/4       | -5        | 1/2-20    | 90304-055400          | 3903-04545           | 064225-002  | 1-7/16             |
| 5/16      | -5        | 1/2-20    | 90305-055400          | 3903-05545           | 320047      | 1-3/8              |
| 1/4       | -6        | 9/16-18   | 90304-065500          | 3903-04546           | 064112-003  | 1-7/16             |
| 5/16      | -6        | 9/16-18   | 90305-065500          | 3903-05546           | 064112-002  | 1-7/16             |
| 3/8       | -6        | 9/16-18   | 90306-065500          | 3903-06546           | 064112-005  | 1-9/16             |
| 3/8       | -8        | 3/4-16    | 90306-085400          | 3903-06548           | 064112-004  | 1-9/16             |
| 1/2       | -8        | 3/4-16    | 90308-085400          | 3903-08548           | 064112-014  | 1-5/8              |
| 1/2       | -10       | 7/8-14    | 90308-105400          | 3903-08550           | 320013-002  | 1-5/8              |
| 5/8       | -12       | 1-1/16-12 | 90H10-125500          | 390H-10552           | 320013      | 1-7/8              |



### Plug with O-Ring

| Part Number | Thread      | Depth | Tube Size |      |
|-------------|-------------|-------|-----------|------|
|             |             |       | SAE       | OD   |
| 064091-001  | 3/4 - 16    | 0.438 | 8         | 0.50 |
| 064091-002  | 9/16 - 18   | 0.391 | 6         | 0.38 |
| 064091-004  | 5/16 - 24   | 0.297 | 2         | 0.12 |
| 064091-005  | 1-1/16 - 12 | 0.594 | 12        | 0.75 |
| 064091-006  | 7/16 - 20   | 0.360 | 4         | 0.25 |
| 064091-007  | 7/8 - 14    | 0.500 | 10        | 0.62 |
| 064091-008  | 1-5/16 - 12 | 0.594 | 16        | 1.00 |
| 064091-009  | 1-5/8 - 12  | 0.594 | 12        | 0.75 |
| 064091-010  | 3/8 - 24    | 0.297 | 3         | 0.19 |
| 064091-011  | 1-7/8 - 12  | 0.594 | 24        | 1.50 |

⚠️WARNING: Cancer and reproductive harm - [www.P65Warnings.ca.gov](http://www.P65Warnings.ca.gov)

Note: See Section 9, Tools, for pusher and die Crown part numbers.

## Thermoplastic Hose Couplings

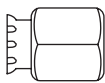

### Cap

| Part Number | Thread    | Depth |
|-------------|-----------|-------|
| 064128-001  | 3/4-16    | 0.75  |
| 064128-002  | 11/16-18  | 0.62  |
| 064128-003  | 7/16-20   | 0.59  |
| 064128-004  | 1 1/16-12 | 1.02  |
| 064128-005  | 7/8-14    | 0.97  |

⚠WARNING: Cancer and reproductive harm - [www.P65Warnings.ca.gov](http://www.P65Warnings.ca.gov)

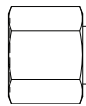

### Cap O-Ring Face Seal

| Part Number | Thread     | Depth |
|-------------|------------|-------|
| 064311S004  | 9/16-18    | 0.58  |
| 064311S006  | 11/16-16   | 0.67  |
| 064311S008  | 13/16-16   | 0.83  |
| 064311S010  | 1-14       | 0.93  |
| 064311S012  | 1 13/16-12 | 1.02  |

⚠WARNING: Cancer and reproductive harm - [www.P65Warnings.ca.gov](http://www.P65Warnings.ca.gov)

## Thermoplastic Hose Couplings Cross Reference

| Furon   | Crown Number | Parker      |
|---|--------------|-------------|
| <b>30° Inverted Flare NPSM</b>                    |              |             |
| 3903-04244  | 320006       | 1MU55-4-4   |
| <b>45° Bent Tube Female Swivel, JIC 37°</b>       |              |             |
| 3903-05606  | 064227-001   | 13755-6-5   |
| 3903-06608  | 320027       | 13755-8-6   |
| <b>90° Long Bent Tube Female Swivel, JIC 37°</b>  |              |             |
| 3903-04844  | 320002       | 14155-4-4   |
| 3903-05846  | 064226-001   | 14155-6-5   |
| 3903-06846  | 064226-007   | 14155-6-6   |
| 3903-06848  | 064226-002   | 14155-8-6   |
| 3903-08848  | 320002-001   | 14155-8-8   |
| 3903-08850  | 320002-002   | 14155-10-8  |
| <b>90° Short Bent Tube Female Swivel, JIC 37°</b> |              |             |
| 3903-04644  | 064226-003   | 1L955-4-4   |
| 3903-04645  | 064226-004   | 13955-5-4   |
| 3903-04646  | 320001       | 13955-6-4   |
| 3903-05646  | 064226-005   | 1L955-6-5   |
| 3903-06646  | 064226-008   | 1L955-6-6   |
| 3903-06648  | 064226-006   | 1L955-8-6   |
| 3903-08648  | 320001-001   | 1L955-8-8   |
| 3903-08650  | 320001-002   | NA          |
| <b>90° Elbow Female Swivel, O-Ring Face Seal</b>  |              |             |
| 3903-06476  | 320009       | 1J955-6-6   |
| <b>Straight w/Female Swivel, O-Ring Face Seal</b> |              |             |
| 3903-04404  | 320000       | 1JS55-4-4   |
| 3903-05406  | 320003       | 1JS55-6-5   |
| 3903-06406  | 064277-016   | 1JS55-6-6   |
| 3903-06408  | 064277-017   | 1JC55-8-6   |
| 3903-08408  | 320003-001   | 1SS55-8-8   |
| 390H-10410  | 064277-010   | 1JS58-10-10 |
| 390N-10410-001                                    | 064277-018   | 10158-10-10 |

| Furon                              | Crown Number | Parker     |
|------------------------------------|--------------|------------|
| <b>Male Rigid</b>                  |              |            |
| 3903-05104                         | 064116-001   | 10155-4-5  |
| 3903-06106                         | 064116-002   | 10155-6-6  |
| 3903-05106                         | 064116-003   | 10155-6-5  |
| 3903-04104                         | 320004       | 10155-4-4  |
| 3903-04106                         | 320005       | 10155-6-4  |
| <b>JIC 37° Male Rigid</b>          |              |            |
| 3903-04504                         | 064113-001   | 10355-4-4  |
| 3903-04506                         | 320044       | 10355-6-4  |
| 3903-03504                         | 064113-005   | 10355-4-3  |
| 3903-05506                         | 064113-010   | 10355-6-5  |
| 3903-06506                         | 064113-009   | 10355-6-6  |
| 3903-06508                         | 064113-002   | 10355-8-6  |
| 3903-08508                         | 320044-001   | 10355-8-8  |
| 3903-08510                         | 320044-002   | 10355-8-10 |
| <b>Male O-Ring Straight Thread</b> |              |            |
| 3903-03D04                         | 064224-002   | 10555-4-3  |
| 3903-04D05                         | 320007       | 10555-4-4  |
| 3903-06D06                         | 320007-001   | 10555-6-6  |
| <b>SAE 45° Female Swivel</b>       |              |            |
| 3903-03544                         | 064112-011   | 10655-4-3  |
| 3903-04545                         | 064225-002   | 10655-5-4  |
| <b>JIC 37° Female Swivel</b>       |              |            |
| 3903-03544                         | 064112-011   | 10655-4-3  |
| 3903-04544                         | 064112-001   | 10655-4-4  |
| 3903-04546                         | 064112-003   | 10655-6-4  |
| 3903-05546                         | 064112-002   | 10655-6-5  |
| 3903-06546                         | 064112-005   | 10655-6-6  |
| 3903-06548                         | 064112-004   | 10655-8-6  |
| 3903-08548                         | 064112-014   | 10655-8-8  |
| 3903-08550                         | 320013-002   | 10655-8-10 |

## Rubber Hose



| I.D.<br>(in)                         | Working<br>Pressure<br>(psi) | Minimum Bend<br>Radius inch | SAE<br>Spec. | Vendor<br>Number | Bulk<br>Part Number | Length        |            |            |
|--------------------------------------|------------------------------|-----------------------------|--------------|------------------|---------------------|---------------|------------|------------|
|                                      |                              |                             |              |                  |                     | 10 ft         | 200 ft     | 250 ft     |
| <b>Wire Braid High Tensile Steel</b> |                              |                             |              |                  |                     |               |            |            |
| 1/4                                  | 3000                         | 1.5                         | 100R17       | 4M3K-XTF         | 320041-012-01       |               |            | 320041-012 |
| 1/4                                  | 5000                         |                             | 100R16       | 4M2T-MTF         | 320041-009-01       |               |            | 320041-009 |
| 1/4                                  | 3275                         | 4.0                         | 100R1        | 4G1              | 320041-010-01       |               |            | 320041-010 |
| 3/8                                  | 3000                         | 2.5                         | 100R17       | 6M3K             | 320041-002-01       |               |            | 320041-002 |
| 3/8                                  | 4800                         | 5.0                         | 100R2        | 6G2              | 320041-006-01       |               |            | 320041-006 |
| 3/8                                  | 3000                         |                             | 100R17       | 6M3K-XTF         | 320041-007-01       |               |            | 320041-007 |
| 3/8                                  | 3500                         |                             | 100R16       | 6M2T             | 320041-008-01       |               |            | 320041-008 |
| 1/2                                  | 3000                         | 3.5                         | 100R17       | 8M3K             | 320041-003-01       |               |            | 320041-003 |
| 1/2                                  | 3500                         | 3.5                         | 100R16       | 8M2T             | 320041-005-01       |               |            | 320041-005 |
| 1/2                                  | 4000                         | 3.5                         | 100R19       | 8M4KL            | 320041-013-01       |               | 320041-013 |            |
| 5/8                                  | 3000                         | 4.0                         | 100R17       | 10M3K            | 320041-004-01       |               |            | 320041-004 |
| 3/4                                  | 3000                         | 4.8                         | 100R17       | 12M3K            | 320041-011-01       |               |            | 320041-011 |
| <b>Fiber Braid</b>                   |                              |                             |              |                  |                     |               |            |            |
| 1/2                                  | 300                          | 5.0                         |              | 8LOLA            | 064100-001          | 324100-001-10 |            |            |
| 5/8                                  | 300                          | 6.0                         |              | 10LOLA           | 064100-105          |               |            |            |
| 3/4                                  | 750                          | 6.0                         | 100R3        | 12G3H            | 064100-018          | 324100-018-10 |            |            |
| 3/4                                  | 300                          | 7.0                         |              | 12LOLA           | 064100-037          | 324100-037-10 |            |            |
| 1                                    | 565                          | 8.0                         | 100R3        | 16G3H            | 064100-027          | 324100-027-10 |            |            |

Female Flat-Face Swivel, O-Ring Face Seal

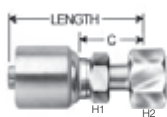

Female Flat-Face Swivel - 90° Bent Tube, O-Ring Face Seal

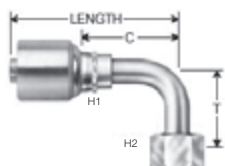

Female Flat-Face Swivel - 45° Bent Tube, O-Ring Face Seal

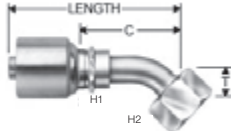

Female JIC 37° Flare Swivel

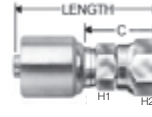

Female JIC 37° Flare Swivel - 45° Bent Tube

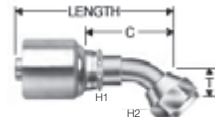

| Hose I.D.<br>mm (in.)  | Vendor<br>Number | Part<br>Number | Thread<br>Size | H1<br>(in) | H2<br>(in) | "T" Drop<br>mm (in) | Length<br>mm (in) | "C" Cut-Off<br>mm (in) |
|--|------------------|----------------|----------------|------------|------------|---------------------|-------------------|------------------------|
| <b>Female Flat-Face Swivel, O-Ring Face Seal</b>                 |                  |                |                |            |            |                     |                   |                        |
| 6.4 (1/4)  | 4G-4FFORX        | 320042-001     | 9/16-18        | 9/16       | 11/16      | NA                  | 54.5 (2.15)       | 28.5 (1.12)            |
| 6.4 (1/4)  | 4G-6FFORX        | 320042-002     | 11/16-16       | 5/8        | 13/16      | NA                  | 57 (2.24)         | 31 (1.22)              |
| 9.5 (3/8)  | 6G-4FFORX        | 320042-085     | 9/16-18        | 21/32      | 11/16      | NA                  | 57 (2.24)         | 29.1 (1.15)            |
| 9.5 (3/8)  | 6G-6FFORX        | 320042-003     | 11/16-16       | 5/8        | 13/16      | NA                  | 59 (2.32)         | 31 (1.22)              |
| 9.5 (3/8)  | 6G-8FFORX        | 320037         | 13/16-16       | 3/4        | 15/16      | NA                  | 64 (2.52)         | 36.1 (1.42)            |
| 12.7 (1/2)   | 8G-8FFORX        | 320042-004     | 13/16-16       | 13/16      | 15/16      | NA                  | 73.5 (2.89)       | 36 (1.42)              |
| 12.7 (1/2)   | 8G-10FFORX       | 320042-051     | 1-14           | 15/16      | 1-1/8      | NA                  | 81.0 (3.19)       | 43.5 (1.71)            |
| 12.7 (1/2)   | 8G-12FFORX       | 320042-087     | 1 3/16-12      | 15/16      | 1-3/8      | NA                  | 84.3 (3.32)       | 46.8 (1.84)            |
| 15.8 (5/8)   | 10G-10FFORX      | 320042-005     | 1-14           | 1          | 1-1/8      | NA                  | 81.5 (3.21)       | 44.0 (1.73)            |
| 19.0 (3/4)   | 12G-12FFORX      | 320042-088     | 1 3/16-12      | 1 1/16     | 1-3/8      | NA                  | 96.0 (3.78)       | 45.0 (1.77)            |
| <b>Female Flat-Face Swivel 90° Bent Tube, O-Ring Face Seal</b>   |                  |                |                |            |            |                     |                   |                        |
| 6.4 (1/4)  | 4G-4FFORX90S     | 320042-013     | 9/16-18        | 1/2        | 11/16      | 20.8 (0.82)         | 60.4 (2.38)       | 34.4 (1.35)            |
| 6.4 (1/4)  | 4G-4FFORX90M     | 320042-014     | 9/16-18        | 1/2        | 11/16      | 32.0 (1.26)         | 55.2 (2.17)       | 29.2 (1.15)            |
| 6.4 (1/4)  | 4G-4FFORX90L     | 320042-015     | 9/16-18        | 1/2        | 11/16      | 45.7 (1.80)         | 55.2 (2.17)       | 29.2 (1.15)            |
| 9.5 (3/8)  | 6G-6FFORX90S     | 320042-016     | 11/16-16       | 5/8        | 13/16      | 22.9 (0.90)         | 64.7 (2.55)       | 36.7 (1.44)            |
| 9.5 (3/8)  | 6G-6FFORX90M     | 320042-077     | 11/16-16       | 5/8        | 13/16      | 38.4 (1.51)         | 64.7 (2.55)       | 36.8 (1.45)            |
| 9.5 (3/8)  | 6G-6FFORX90L     | 320042-048     | 11/16-16       | 5/8        | 13/16      | 54.1 (2.13)         | 62.9 (2.48)       | 35.0 (1.38)            |
| 9.5 (3/8)  | 6G-8FFORX90S     | 320042-017     | 13/16-16       | 5/8        | 15/16      | 29.2 (1.15)         | 73.0 (2.87)       | 45.0 (1.77)            |
| 12.7 (1/2)   | 8G-8FFORX90S     | 320042-018     | 13/16-16       | 13/16      | 15/16      | 29.2 (1.15)         | 83.9 (3.30)       | 46.5 (1.83)            |
| 12.7 (1/2)   | 8G-8FFORX90M     | 320042-047     | 13/16-16       | 13/16      | 15/16      | 41.2 (1.62)         | 83.9 (3.30)       | 46.5 (1.83)            |
| 12.7 (1/2)   | 8G-8FFORX90L     | 320042-046     | 13/16-16       | 13/16      | 15/16      | 63.8 (2.51)         | 83.9 (3.30)       | 46.5 (1.83)            |
| 12.7 (1/2)   | 8G-8FFORX90-083  | 320042-052     | 13/16-16       | 13/16      | 15/16      | 83.0 (3.26)         | 83.9 (3.30)       | 46.5 (1.83)            |
| 12.7 (1/2)   | 8G-10FFORX90S    | 320042-019     | 1-14           | 13/16      | 1-1/8      | 32.3 (1.27)         | 84.0 (3.30)       | 46.5 (1.83)            |
| 15.8 (5/8)   | 10G-10FFORX90S   | 320042-020     | 1-14           | 15/16      | 1-1/8      | 32.3 (1.27)         | 83.4 (3.28)       | 45.9 (1.81)            |
| 15.8 (5/8)   | 10G-10FFORX90M   | 320042-075     | 1-14           | 15/16      | 1-1/8      | 47.0 (1.85)         | 77.6 (3.06)       | 40.2 (1.58)            |
| 15.8 (5/8)   | 10G-10FFORX90L   | 320042-053     | 1-14           | 15/16      | 1-1/8      | 70.1 (2.76)         | 77.5 (3.05)       | 40.0 (1.57)            |
| 19.0 (3/4)   | 12-G12FFORX90M   | 320042-089     | 1 3/16-12      | 11/16      | 1-5/8      | 57.9(2.28)          | 106.8(4.20)       | 55.8 (2.20)            |
| <b>Female Flat-Face Swivel - 45° Bent Tube, O-Ring Face Seal</b> |                  |                |                |            |            |                     |                   |                        |
| 6.4 (1/4)  | 4G-4FFORX45      | 320042-008     | 9/16-18        | 9/16       | 11/16      | 10.4 (0.41)         | 65 (2.56)         | 39 (1.54)              |
| 6.4 (1/4)  | 4G-6FFORX45      | 320042-009     | 11/16-16       | 5/8        | 13/16      | 10.9 (0.43)         | 68.5 (2.70)       | 42.5 (1.67)            |
| 9.5 (3/8)  | 6G-6FFORX45      | 320042-010     | 11/16-16       | 5/8        | 13/16      | 10.9 (0.43)         | 69.8 (2.75)       | 41.9 (1.65)            |
| 9.5 (3/8)  | 6G-4FFORX45S     | 320042-083     | 9/16-18        | 5/8        | 11/16      | 10.0(0.39)          | 66.1 (2.60)       | 38.1 (1.50)            |
| 12.7 (1/2)   | 8G-8FFORX45      | 320042-011     | 13/16-16       | 13/16      | 15/16      | 15 (0.59)           | 89 (3.5)          | 52.5 (2.07)            |
| 12.7 (1/2)   | 8G-10DD0EZ45     | 320042-084     | 1-14           | 13/16      | 1-1/8      | 16.5 (0.65)         | 89.5 (3.52)       | 52.1 (2.05)            |
| 15.8 (5/8)   | 10G-10FFORX45    | 320042-012     | 1-14           | 1          | 1-1/8      | 16.5 (0.65)         | 89 (3.5)          | 51.4 (2.02)            |
| <b>Female JIC 37° Flare Swivel English Hex</b>                   |                  |                |                |            |            |                     |                   |                        |
| 6.4 (1/4)  | 4GE-4FJX         | 320042-059     | 7/16 - 20      | 1/2        | 9/16       | NA                  | 53.4 (2.10)       | 27.4 (1.08)            |
| 6.4 (1/4)  | 4GE-6FJX         | 320042-060     | 9/16 - 18      | 9/16       | 3/4        | NA                  | 56.3 (2.22)       | 30.2 (1.19)            |
| 9.5 (3/8)  | 6GE-6FJX         | 320042-061     | 9/16-18        | 5/8        | 3/4        | NA                  | 58.8 (2.31)       | 30.2 (1.19)            |
| 9.5 (3/8)  | 6GE-8FJX         | 320042-062     | 3/4-16         | 11/16      | 7/8        | NA                  | 63.1 (2.48)       | 35.1 (1.38)            |
| <b>Female JIC 37° Flare Swivel - 45° Bent Tube</b>               |                  |                |                |            |            |                     |                   |                        |
| 6.4 (1/4)  | 4GE-4FJX45       | 320042-063     | 7/16 - 20      | 1/2        | 9/16       | 11.9 (.47)          | 58.0 (2.28)       | 32.0 (1.26)            |
| 6.4 (1/4)  | 4G-5FJX45S       | 320042-054     | 1/2-20         | 1/2        | 5/8        | 14.2 (0.56)         | 65.0 (2.56)       | 39.0 (1.54)            |
| 9.5 (3/8)  | 6G-6FJX45        | 320042-023     | 9/16-18        | 5/8        | 11/16      | 14.2 (0.56)         | 73.9 (2.91)       | 46.0 (1.81)            |
| 9.5 (3/8)  | 6G-8FJX45        | 320042-050     | 3/4-16         | 5/8        | 7/8        | 17.5 (0.69)         | 73.1 (2.88)       | 45.2 (1.78)            |
| 12.7 (1/2)   | 8G-8FJX45        | 320042-044     | 3/4-16         | 13/16      | 7/8        | 17.5 (.69)          | 84.1 (3.31)       | 46.6 (1.83)            |

▲WARNING: Cancer and reproductive harm - [www.P65Warnings.ca.gov](http://www.P65Warnings.ca.gov)

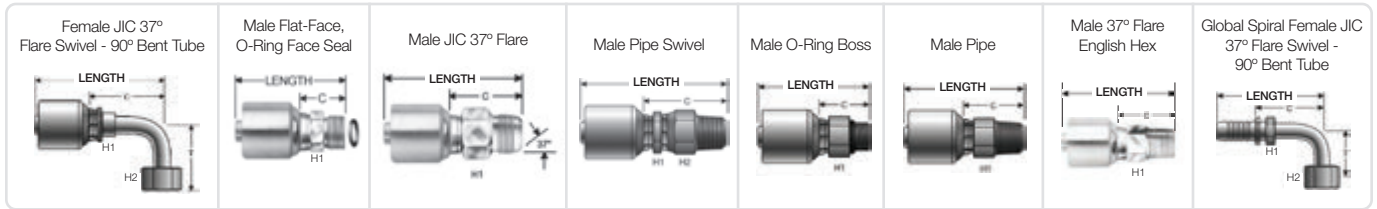

| Hose I.D.<br>mm (in.)  | Vendor Number | Part<br>Number | Thread<br>Size | H1<br>(in) | H2<br>(in) | "T" Drop<br>mm (in) | Length<br>mm (in) | "C" Cut-Off<br>mm (in) |
|--|---------------|----------------|----------------|------------|------------|---------------------|-------------------|------------------------|
| <b>Female JIC 37° Flare Swivel</b>                             |               |                |                |            |            |                     |                   |                        |
| 6.4 (1/4)  | 4G-4FJX       | 320042-021     | 7/16-20        | 1/2        | 9/16       | NA                  | 53.4 (2.10)       | 27.4 (1.08)            |
| 6.4 (1/4)  | 4G-6FJX       | 320042-037     | 9/16-18        | 9/16       | 3/4        | NA                  | 56.3 (2.22)       | 30.2 (1.19)            |
| 9.5 (3/8)  | 6G-6FJX       | 320042-022     | 9/16-18        | 5/8        | 3/4        | NA                  | 58.8 (2.31)       | 30.2 (1.19)            |
| 9.5 (3/8)  | 10G-6-6       | 320073         | 9/16-18        | 11/16      | 11/16      | NA                  | 58 (2.29)         | 32.0 (1.26)            |
| 9.5 (3/8)  | 6G-8FJX       | 320042-031     | 3/4-16         | 11/16      | 7/8        | NA                  | 63.1 (2.48)       | 35.1 (1.38)            |
| 12.7 (1/2)   | 8G-8FJX       | 320042-045     | 3/4-16         | 13/16      | 7/8        | NA                  | 71.6 (2.82)       | 34.1 (1.34)            |
| 12.7 (1/2)   | 8G-12FJX      | 320042-073     | 1 1/16 - 12    | 1          | 1-1/4      | NA                  | 80.1 (3.15)       | 42.6 (1.68)            |
| 15.8 (5/8)   | 10G-8FJX      | 320042-071     | 3/4-16         | 15/16      | 7/8        | NA                  | 73.6 (2.90)       | 36.1 (1.42)            |
| 15.8 (5/8)   | 10G-10FJX     | 320042-042     | 7/8-14         | 15/16      | 1-1/16     | NA                  | 77.1 (3.04)       | 39.7 (1.56)            |
| <b>Female JIC 37° Flare Swivel - 90° Bent Tube</b>             |               |                |                |            |            |                     |                   |                        |
| 6.4 (1/4)  | 4G-4JX90M     | 320042-072     | 7/16 - 20      | 1/2        | 9/16       | 22.4 (0.88)         | 52.25 (2.06)      | 26.2 (1.03)            |
| 6.4 (1/4)  | 4G-5FJX90L    | 320042-039     | 1/2 - 20       | 1/2        | 5/8        | 45.7 (1.80)         | 55.2 (2.17)       | 29.2 (1.15)            |
| 9.5 (3/8)  | 6G-6FJX90S    | 320042-024     | 9/16 - 18      | 5/8        | 11/16      | 21.6 (0.85)         | 60 (2.36)         | 31.0 (1.22)            |
| 9.5 (3/8)  | 6GE-6FJX90S   | 320042-064     | 9/16 - 18      | 5/8        | 11/16      | 85.0 (21.6)         | 60.0 (2.36)       | 31.0 (1.22)            |
| 9.5 (3/8)  | 6G-6FJX90M    | 320042-025     | 9/16 - 18      | 5/8        | 11/16      | 28.7 (1.13)         | 60.0 (2.36)       | 31.0 (1.22)            |
| 9.5 (3/8)  | 6G-6FJX90L    | 320042-040     | 9/16 - 18      | 5/8        | 11/16      | 55.4 (2.18)         | 66.0 (2.60)       | 38.1 (1.50)            |
| 9.5 (3/8)  | 6G-8FJX90S    | 320042-038     | 3/4 - 16       | 5/8        | 15/16      | 27.7 (1.09)         | 69.7 (2.74 )      | 41.8 (1.65)            |
| 9.5 (3/8)  | 6GE-8FJX90S   | 320042-065     | 3/4 - 16       | 5/8        | 7/8        | 27.7 (1.09)         | 69.7 (2.74 )      | 41.8 (1.65)            |
| 12.7 (1/2)   | 8G-8FJX90S    | 320042-074     | 3/4 - 16       | 13/16      | 7/8        | 29.0 (1.14)         | 80.3 (3.16)       | 42.8 (1.69)            |
| 12.7 (1/2)   | 8G-8FJX90M    | 320042-043     | 3/4 - 16       | 13/16      | 7/8        | 41.0 (1.38)         | 74.3 (2.93)       | 36.8 (1.45)            |
| 12.7 (1/2)   | 8G-8FJX90L    | 320042-078     | 3/4 - 16       | 13/16      | 7/8        | 64.0 (2.52)         | 74.0 (2.91)       | 36.6 (1.44)            |
| 12.7 (1/2)   | 8G-10FJX90M   | 320042-049     | 7/8 - 14       | 13/16      | 1          | 44.5 (1.75)         | 81.3 (3.20)       | 43.9 (1.73)            |
| 15.8 (5/8)   | 10G-10FJX90S  | 320042-041     | 7/8 - 14       | 15/16      | 1          | 31.2 (1.23)         | 85.5 (3.37)       | 48.0 (1.89)            |
| <b>Male Flat-Face, O-Ring Face Seal</b>                        |               |                |                |            |            |                     |                   |                        |
| 9.5 (3/8)  | 6G-6MFFOR     | 320042-006     | 11/16 - 16     | 3/4        | NA         | NA                  | 56.0 (2.20)       | 28.1 (1.11)            |
| 9.5 (3/8)  | 6G-8MFFOR     | 320042-007     | 13/16 - 16     | 7/8        | NA         | NA                  | 59.0 (2.32)       | 31.1 (1.22)            |
| 15.8(5/8)  | 10G-12MFFOR   | 320042-069     | 1 3/16 - 12    | 1-1/4      | NA         | NA                  | 72.0 (2.83)       | 34.5 (1.36)            |
| 19.0 (3/4)   | 12G-12MFFOR   | 320042-090     | 1 3/16-12      | 1-1/4      | NA         | NA                  | 90.0 (3.54)       | 39.0 (1.54)            |
| <b>Male JIC 37° Flare</b>                                      |               |                |                |            |            |                     |                   |                        |
| 9.5 (3/8)  | 6G-6MJ        | 320042-032     | 9/16-18        | 5/8        | NA         | NA                  | 57.5 (2.26)       | 29.6 (1.17)            |
| 9.5 (3/8)  | 6G-8MJ        | 320042-033     | 3/4-16         | 3/4        | NA         | NA                  | 61.0 (2.40)       | 33.1 (1.30)            |
| <b>Male Pipe Swivel</b>  |               |                |                |            |            |                     |                   |                        |
| 9.5 (3/8)  | 6G-4MPX       | 320042-055     | 1/4 - 18       | 5/8        | NA         | NA                  | 72.8 (2.87)       | 44.9 (1.77)            |
| 9.5 (3/8)  | 6G-6MPX       | 320042-056     | 3/8 - 18       | 5/8        | NA         | NA                  | 71.5 (2.81)       | 43.6 (1.72)            |
| 9.5 (3/8)  | 6G-8MPX       | 320042-057     | 1/2 - 14       | 3/4        | NA         | NA                  | 77.5 (3.05)       | 49.5 (1.95)            |
| <b>Male O-Ring Boss</b>  |               |                |                |            |            |                     |                   |                        |
| 6.4 (1/4)  | 4G-4MB        | 320042-082     | 7/16 -20       | 9/16       | NA         | NA                  | 50.5 (1.99)       | 24.5 (0.96)            |
| <b>Male Pipe</b>   |               |                |                |            |            |                     |                   |                        |
| 6.4 (1/4)  | 4G-4MP        | 320042-036     | 1/4 - 18       | 9/16       | NA         | NA                  | 55.0 (2.17)       | 29.0 (1.14)            |
| 9.5 (3/8)  | 6G-4MP        | 320042-076     | 1/4 - 16       | 5/8        | NA         | NA                  | 59.0 (2.32)       | 31.1 (1.22)            |
| <b>Male 37° Flare English Hex</b>                              |               |                |                |            |            |                     |                   |                        |
| 9.5 (3/8)  | 6GE-8MJ       | 320042-058     | 3/4-16         | 3/4        | NA         | NA                  | 61.0 (2.40)       | 33.1 (1.30)            |
| <b>Global Spiral Female JIC 37° Flare Swivel 90° Bent Tube</b> |               |                |                |            |            |                     |                   |                        |
| 12.7 (1/2)   | 8GS-8FJX90S   | 320042-081     | 3/4 -16        | 7/8        | 7/8        | 29.0 (1.14)         | 86.0 (3.39)       | 48.6 (1.91)            |
| 12.7 (1/2)   | 8GS-8FJX90M   | 320042-080     | 3/4 -16        | 7/8        | 7/8        | 41.0 (1.61)         | 92.0 (3.62)       | 54.6 (2.15)            |

⚠WARNING: Cancer and reproductive harm - [www.P65Warnings.ca.gov](http://www.P65Warnings.ca.gov)

# Rubber Hose Couplings

Global Spiral Ferrule for 4-Spiral Hose

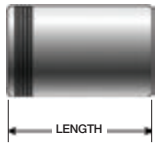

Male O-Ring Face Plug

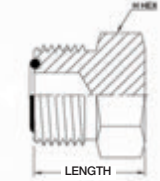

Male 37° Plug

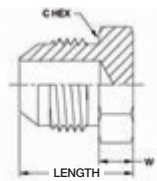

## Komatsu Metric Fittings

Female Swivel

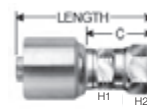

Female Swivel - 90° Bent Tube

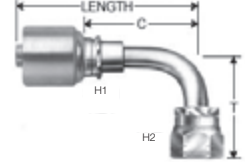

| Hose I.D.<br>mm (in.)                          | Vendor Number | Part Number | Inside Diameter | Length<br>mm (in) | Outside Diameter |                  |
|--|---------------|-------------|-----------------|-------------------|------------------|------------------|
| <b>Global Spiral Ferrule for 4-Spiral Hose</b> |               |             |                 |                   |                  |                  |
| 12.7 (1/2)                                     | 8GS1F-4       | 320042-079  | 12.7 (1.5)      | 36.6 (1.44)       | 34.4 (1.35)      |                  |
|  | Vendor Number | Part Number | Thread Size     | Length<br>mm (in) | H Hex            |                  |
| <b>Male O-Ring Face Plug</b>                   |               |             |                 |                   |                  |                  |
| 3/8  | FS2408-6      | 320043-001  | 11/16-16        | 19.05 (.75)       | 3/4              |                  |
| Tube O.D.                                      | Vendor Number | Part Number | Thread Size     | Length<br>mm (in) | C Hex            | Width<br>mm (in) |
| <b>Male 37° Plug</b>                           |               |             |                 |                   |                  |                  |
| 3/8  | 2408-6        | 320043-002  | 9/16-18         | 21.41 (.843)      | 5/8              | 6.35 (0.25)      |

⚠WARNING: Cancer and reproductive harm - [www.P65Warnings.ca.gov](http://www.P65Warnings.ca.gov)

## Komatsu Metric Fittings

| Hose I.D.<br>mm (in.)                | Vendor Number | Part Number | Thread Size | H1<br>mm (in) | H2<br>mm (in) | "T" Drop<br>mm (in) | Length<br>mm (in) | "C" Cut-Off<br>mm (in) |
|--------------------------------------|---------------|-------------|-------------|---------------|---------------|---------------------|-------------------|------------------------|
| <b>Female Swivel</b>                 |               |             |             |               |               |                     |                   |                        |
| 6.4 (1/4)                            | 4G-4FKX       | 320042-026  | M14 x 1.5   | 14.3          | 19.0          | NA                  | 56.3 (2.22)       | 30.2 (1.19)            |
| 9.5 (3/8)                            | 6G-6FKX       | 320042-027  | M18 x 1.5   | 17.5          | 22.2          | NA                  | 62.8 (2.47)       | 34.9 (1.37)            |
| 12.7 (1/2)                           | 8G-8FKX       | 320042-028  | M22 x 1.5   | 20.7          | 27.0          | NA                  | 74.5 (2.93)       | 37.0 (1.46)            |
| <b>Female Swivel - 90° Bent Tube</b> |               |             |             |               |               |                     |                   |                        |
| 6.4 (1/4)                            | 4G-4FKX90     | 320042-029  | M14 x 1.5   | (1/2)         | (3/4)         | 38 (1.5)            | 69.0 (2.72)       | 43.0 (1.69)            |
| 12.7 (1/2)                           | 8G-8FKX90     | 320042-030  | M22 x 1.5   | (13/16)       | (11/16)       | 35 (1.38)           | 88.0 (3.46)       | 50.5 (1.99)            |

⚠WARNING: Cancer and reproductive harm - [www.P65Warnings.ca.gov](http://www.P65Warnings.ca.gov)

## Section 11

# Wheels and Tires

### Contents

|  |       |
|--|-------|
| Wheel Selection Guide                        | 11.02 |
| Wheel Application Guide                      | 11.03 |
| Polyurethane Wheels by Size                  | 11.04 |
| Non-Polyurethane Wheels by Size              | 11.06 |
| Casters                                      | 11.07 |
| Pallet Truck - One Source Casters            | 11.08 |
| Load Wheel Assemblies w/Shoulder Bearings    | 11.10 |
| Quick Change Load Wheel                      | 11.10 |
| Triple Load Wheels                           | 11.11 |
| Dual Tandem Load Wheels                      | 11.11 |
| Load Wheel Kits and Complete Wheel Kits      | 11.12 |
| Bearings                                     | 11.16 |
| Tire Application Guide                       | 11.19 |
| Polyurethane Tires by Size                   | 11.20 |
| Hole Tires                                   | 11.21 |
| Sweeper Scrubber Rubber Tires                | 11.21 |
| Tire Racks                                   | 11.21 |
| Hubs   | 11.22 |
| Tire Press and Rings                         | 11.24 |
| Tools  | 11.24 |
| Resilient/Pneumatic Tires                    | 11.25 |
| Tubes/Flaps/Rims                             | 11.27 |
| Tire Chains                                  | 11.28 |
| Rubber Tires by Size                         | 11.29 |
| Wheel & Tire Cross Reference by Manufacturer | 11.34 |

#### New Items:

Polyurethane Wheels - p. 11.04-11.05  
Triple Load Wheel - p. 11.11  
Electric Pallet Jack Pre-packaged  
Wheel Kits - p. 11.14-11.15  
Polyurethane Tire - p. 11.20  
Resilient/Pneumatic Tires - p. 11.25-11.26  
Rubber Tires - p. 11.29-11.32

Note: 1910.178(q)(5) (1998) of the Occupational Safety and Health Act (OSHA) requires that "All parts of any such industrial truck requiring replacement shall be replaced only by parts equivalent as to safety with those used in the original design."

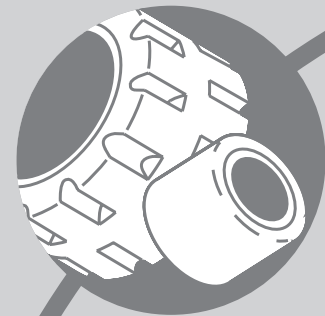

# What's on your truck?



### Crown Brand

All genuine Crown wheels have an identifier code stamped into the hub and Crown Integrity Parts System™ or Crown One Source Lift Truck Parts® with compound number printed on the wheel.



### Wheel Selection Guide Color Reference

If you see one of these wheel colors...



...then your equivalent compound is in this series.

**100**  
SERIES

If you see one of these wheel colors...



...then your equivalent compound is in this series.

**200**  
SERIES

If you see one of these wheel colors...



...then your equivalent compound is in this series.

**300**  
SERIES

If you see one of these wheel colors...



...then your equivalent compound is in this series.

**400**  
SERIES

Note: For additional information contact your local Crown Lift Truck dealer.



## 3-Step Evaluation Process

### Usage Analysis

What is the right amount of wheel and tire usage for your application as it relates to your industry?

### Failure Analysis

What is the cause of your wheel and tire failures (e.g., overloading, heat failure, bond failure, floor debris damage)?

### Best Value Benchmarking

Have you established a best value solution for your application through benchmarking and tracking?

# Wheels

## Application Types

| Wheel Series                          | Compound Number  | Shore A Hardness | Long Runs/<br>Heavy Loads | Dock Boards/<br>Expansion<br>Joints<br>(Chunking) | Metal Chips/<br>Floor Debris<br>(Flat Spotting) | Wet Conditions | Freezer |
|---------------------------------------|--|------------------|---------------------------|---|---|----------------|---------|
| <b>100</b><br>SERIES<br>Light Duty    | These economical 100 Series Light Duty wheel compounds are best suited for light loads and intermittent use.                     |                  |                           |   |   |                |         |
|                                       | 101  | 93A              |                           | ○   | ○   | ○              | ○       |
|                                       | 102  | 95A              |                           | ○   | ○   | ○              | ○       |
| <b>200</b><br>SERIES<br>Midrange      | The Mid-Range wheels are designed for light to medium loads and short to medium runs.  |                  |                           |   |   |                |         |
|                                       | 201  | 83A              |                           | ●   | ●   | ●              | ●       |
|                                       | 204  | 85A              |                           | ●   | ●   | ●              | ●       |
| <b>300</b><br>SERIES<br>High Capacity | For the typical demands of most applications, High Capacity wheels feature compounds designed for high capacities and long runs. |                  |                           |   |   |                |         |
|                                       | 301  | 95A              | ●                         | ●   | ●   | ●              | ●       |
|                                       | 302  | 93A              | ●                         | ●   | ●   | ●              | ●       |
|                                       | 305  | 95A              | ●                         | ●   | ○   | ●              | ●       |
| <b>400</b><br>SERIES<br>Heavy Duty    | Heavy Duty wheels are designed for maximum capacities and extreme runs.  |                  |                           |   |   |                |         |
|                                       | 401  | 93A              | ●                         | ●   | ●   |                |         |
|                                       | 402  | 99A              | ●                         |   |   |                |         |

○ = Good    ● = Better    ● = Best

### Shore A Hardness

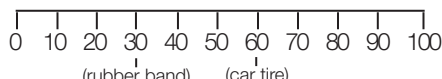

Softer compounds are typically more cut and tear resistant and provide a smoother ride. Harder compounds typically provide improved travel speeds, due to less rolling resistance, and generate less heat.

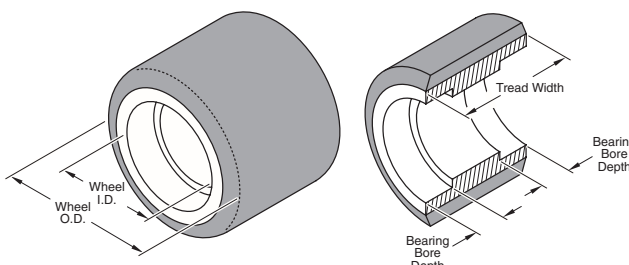

# Polyurethane Wheels by Size

Continued ▶

\* Indicates assemblies; ‡ Add -88 after compound number for assembly; Δ add-66 after compound number for sealed assembly; +> add -77 after compound for shoulder bearing assembly

**WHEELS AND TIRES**

| Tread             |       | Bearing Bore |             | Bearing Ball or Cup | Cone       | Crown Part Number |
|-------------------|-------|--------------|-------------|---------------------|------------|-------------------|
| O.D.              | Width | I.D.         | Depth       |                     |            |                   |
| <b>1.75 O.D.</b>  |       |              |             |                     |            |                   |
| 1.75              | 1.31  | 0.760        | NA          | NA                  | NA         | 115385            |
| <b>2.50 O.D.</b>  |       |              |             |                     |            |                   |
| 2.50              | 2.06  | 1.187        | NA          | NA                  | NA         | 082442*           |
| 2.50              | 2.06  | 1.187        | NA          | 073894              | NA         | 082443            |
| 2.50              | 2.06  | 1.187        | NA          | 073894              | NA         | 310443            |
| 2.50              | 3.25  | 2.170        | NA          | NA                  | NA         | 808981-001*       |
| <b>2.75 O.D.</b>  |       |              |             |                     |            |                   |
| 2.75              | 2.00  | 1.456        | 0.472       | NA                  | NA         | 310325            |
| <b>2.90 O.D.</b>  |       |              |             |                     |            |                   |
| 2.90              | 3.88  | 1.850        | NA          | NA                  | NA         | 314507            |
| 2.90              | 3.88  | 1.850        | 0.55        | NA                  | NA         | 044506-101*       |
| <b>2.91 O.D.</b>  |       |              |             |                     |            |                   |
| 2.91              | 3.86  | 1.850        | 0.55        | 065081-019          | NA         | 044507            |
| <b>3.00 O.D.</b>  |       |              |             |                     |            |                   |
| 3.00              | 2.00  | 1.188        | NA          | NA                  | NA         | 073918            |
| 3.00              | 2.00  | 2.047        | 0.63        | 065081-021          | NA         | 310080            |
| 3.00              | 2.06  | 1.190        | thru        | NA                  | NA         | 072718*           |
| 3.00              | 3.50  | 1.850        | 0.56        | 311000-005          | NA         | 310189‡           |
| 3.00              | 3.54  | 1.850        | 0.55        | 311000-005          | NA         | 310248            |
| 3.00              | 3.75  | 1.625        | 0.44        | NA                  | NA         | 310083            |
| 3.00              | 4.00  | 1.850        | 0.56        | 311000-005          | NA         | 310182            |
| 3.00              | 6.00  | 1.780        | 0.78        | NA                  | NA         | 310226            |
| 3.00              | 6.00  | 2.047        | 1.44        | 065081-021          | NA         | 310466            |
| 3.00              | 6.50  | 2.047        | 1.812       | 065081-021          | NA         | 310323‡           |
| <b>3.125 O.D.</b> |       |              |             |                     |            |                   |
| 3.125             | 4.40  | 2.170        | 0.8         | 065081-062          | NA         | 313016            |
| <b>3.23 O.D.</b>  |       |              |             |                     |            |                   |
| 3.23              | 4.33  | 2.170        | NA          | NA                  | NA         | 808909*           |
| <b>3.25 O.D.</b>  |       |              |             |                     |            |                   |
| 3.25              | 1.57  | 2.047        | 0.59        | 065081-021          | NA         | 310282            |
| 3.25              | 1.75  | 1.850        | 0.55        | 311000-005          | NA         | 310220            |
| 3.25              | 1.88  | 2.047        | 0.595       | NA                  | NA         | 310250            |
| 3.25              | 2.00  | 2.047        | 0.59        | 065081-070          | NA         | 154840‡           |
| 3.25              | 2.00  | 2.047        | 0.59        | NA                  | NA         | 310125‡           |
| 3.25              | 2.25  | 1.850        | 0.55        | 311000-005          | NA         | 310156            |
| 3.25              | 2.44  | 2.047        | 0.594       | 065081-021          | NA         | 310468‡ +>        |
| 3.25              | 2.63  | 2.047        | 1.14        | 065081-021          | NA         | 310118            |
| 3.25              | 2.88  | 1.850        | 0.55        | 311000-005          | NA         | 310157            |
| 3.25              | 2.88  | 1.980        | Non-Typical | 065134              | 312000-008 | 310194            |
| 3.25              | 2.88  | 2.047        | 0.81        | 311000-001          | NA         | 075999            |
| 3.25              | 2.88  | 2.047        | 0.81        | 065081-021          | NA         | 076848*           |
| 3.25              | 2.88  | 2.047        | 0.59        | 065081-021          | NA         | 310078            |
| 3.25              | 2.94  | 1.980        | NA          | 065134              | 312000-008 | 310150            |
| 3.25              | 2.95  | 1.850        | 0.63        | 065081-020          | NA         | 083878            |
| 3.25              | 3.00  | 2.047        | 0.81        | 311000-006          | NA         | 310141            |
| 3.25              | 3.00  | 2.047        | 0.66        | 065081-021          | NA         | 310149            |
| 3.25              | 3.00  | 2.047        | 0.59        | 311000-006          | NA         | 310212            |
| 3.25              | 3.13  | 2.047        | 0.975       | NA                  | NA         | 310241            |
| 3.25              | 3.25  | 2.047        | 0.59        | 065081-021          | NA         | 077084‡           |
| 3.25              | 3.25  | 2.047        | 0.59        | 065081-021          | NA         | 310300            |
| 3.25              | 3.25  | 2.047        | 0.83        | 311000-011          | NA         | 310135            |
| 3.25              | 3.39  | 2.170        | NA          | NA                  | NA         | 808984-001*       |
| 3.25              | 3.75  | 1.750        | thru        | NA                  | NA         | 310188            |
| 3.25              | 3.86  | 1.848        | 0.63        | 065081-020          | NA         | 083879            |
| 3.25              | 3.88  | 1.849        | 0.63        | NA                  | NA         | 082283-001*       |
| 3.25              | 3.88  | 1.849        | 0.63        | NA                  | NA         | 082284            |
| 3.25              | 3.88  | 2.047        | 0.81        | 311000-001          | NA         | 310140            |
| 3.25              | 4.00  | 1.850        | 0.55        | 311000-005          | NA         | 310174            |
| 3.25              | 4.00  | 2.047        | 0.69        | NA                  | NA         | 071665            |
| 3.25              | 4.20  | 2.047        | 1.18        | 065081-021          | NA         | 310180            |
| 3.25              | 4.20  | 2.047        | 0.59        | 065081-021          | NA         | 310219            |
| 3.25              | 4.28  | 2.047        | 0.83        | 065081-021          | NA         | 310137            |
| 3.25              | 4.41  | 2.170        | 0.80        | 065081-062          | NA         | 813015            |

| Tread            |       | Bearing Bore |       | Bearing Ball or Cup | Cone       | Crown Part Number |
|------------------|-------|--------------|-------|---------------------|------------|-------------------|
| O.D.             | Width | I.D.         | Depth |                     |            |                   |
| 3.25             | 4.41  | 2.170        | 0.80  | 065081-062          | NA         | 313015            |
| 3.25             | 4.41  | 2.170        | 0.80  | NA                  | NA         | 813014*           |
| 3.25             | 4.48  | 2.047        | 0.58  | NA                  | NA         | 310316            |
| 3.25             | 4.50  | 1.575        | 0.56  | 311000-004          | NA         | 310185            |
| 3.25             | 4.50  | 2.047        | 0.59  | 065081-021          | NA         | 310244‡           |
| 3.25             | 4.50  | 2.047        | 0.71  | 065081-021          | NA         | 310245*           |
| 3.25             | 4.50  | 2.160        | 0.52  | 065081-062          | NA         | 123603‡           |
| 3.25             | 4.50  | 2.160        | 1.03  | 065081-025          | NA         | 310230            |
| 3.25             | 4.50  | 2.440        | 0.66  | 065081-025          | NA         | 083970            |
| 3.25             | 4.50  | 2.440        | 0.66  | NA                  | NA         | 100029*           |
| 3.25             | 4.71  | 2.047        | 0.83  | 311000-001          | NA         | 310136            |
| 3.25             | 4.84  | 2.047        | 0.80  | NA                  | NA         | 310231            |
| 3.25             | 5.00  | 2.047        | 0.59  | 065081-021          | NA         | 077086‡           |
| 3.25             | 5.50  | 1.980        | 0.69  | 065134              | 065135     | 310210            |
| 3.25             | 5.75  | 2.047        | 0.83  | 311000-001          | NA         | 310138            |
| 3.25             | 5.75  | 2.440        | 0.69  | 311000-013          | NA         | 310187            |
| 3.25             | 5.88  | 2.047        | 0.59  | 065081-021          | NA         | 310077            |
| 3.25             | 5.91  | 2.047        | 0.59  | 065081-021          | NA         | 310175            |
| 3.25             | 5.91  | 2.047        | 1.18  | 065081-021          | NA         | 310178‡           |
| 3.25             | 5.91  | 2.047        | 1.18  | 065081-070          | NA         | 065081-070        |
| 3.25             | 5.91  | 2.047        | 1.18  | 065081-021          | NA         | 310478‡           |
| 3.25             | 5.94  | 2.047        | 0.59  | NA                  | NA         | 310251            |
| 3.25             | 5.98  | 2.047        | 1.368 | 065081-071          | NA         | 310242‡           |
| 3.25             | 6.00  | 1.980        | 0.91  | 065134              | 065135     | 310084            |
| 3.25             | 6.00  | 2.047        | 0.59  | 065081-021          | NA         | 310085            |
| 3.25             | 6.00  | 2.047        | 0.778 | 065081-071          | NA         | 310465            |
| 3.25             | 6.00  | 2.047        | 0.81  | 065081-021          | NA         | 310144‡           |
| 3.25             | 6.00  | 2.047        | 1.187 | 311000-001          | NA         | 310147            |
| 3.25             | 6.00  | 2.047        | 1.438 | NA                  | NA         | 310252‡           |
| 3.25             | 6.25  | 2.047        | 0.81  | 311000-001          | NA         | 310145            |
| 3.25             | 6.38  | 2.047        | 0.81  | 311000-001          | NA         | 310146            |
| 3.25             | 6.38  | 2.047        | 1.18  | 065081-021          | NA         | 310190            |
| 3.25             | 6.38  | 2.047        | 1.06  | NA                  | NA         | 310218            |
| 3.25             | 6.50  | 1.980        | 1.18  | 065134              | 065135     | 310093            |
| 3.25             | 6.50  | 2.047        | 0.59  | 065081-021          | NA         | 310000            |
| 3.25             | 6.50  | 2.047        | 0.812 | 065081-051          | NA         | 310243            |
| 3.25             | 6.50  | 2.047        | 0.97  | NA                  | NA         | 310240            |
| 3.25             | 6.50  | 2.047        | 1.44  | 065081-021‡         | NA         | 100462‡           |
| 3.25             | 6.50  | 2.047        | 1.681 | 065081-070‡         | NA         | 310041            |
| <b>3.35 O.D.</b> |       |              |       |                     |            |                   |
| 3.35             | 2.91  | 2.170        | NA    | NA                  | NA         | 808983-001*       |
| 3.35             | 2.91  | 2.170        | NA    | NA                  | NA         | 808983-002*       |
| <b>3.38 O.D.</b> |       |              |       |                     |            |                   |
| 3.38             | 2.25  | 1.850        | 0.55  | 311000-005          | NA         | 310162            |
| 3.38             | 2.63  | 1.968        | 0.94  | NA                  | NA         | 310100            |
| 3.38             | 2.63  | 1.980        | 1.24  | 065134              | 312000-008 | 310101            |
| 3.38             | 2.63  | 2.047        | 0.67  | 065081-021          | NA         | 310110            |
| 3.38             | 2.63  | 2.047        | 0.76  | 065081-021          | NA         | 310111            |
| 3.38             | 2.63  | 2.047        | 1.14  | 065081-021          | NA         | 310112            |
| 3.38             | 2.75  | 2.047        | 0.81  | 311000-001          | NA         | 310088            |
| 3.38             | 2.75  | 2.047        | 0.91  | 065081-021          | NA         | 310170            |
| 3.38             | 2.75  | 2.047        | 0.61  | 065081-021          | NA         | 310184            |
| 3.38             | 5.75  | 2.047        | 1.45  | 065081-021          | NA         | 310113            |
| <b>3.50 O.D.</b> |       |              |       |                     |            |                   |
| 3.50             | 1.88  | 2.047        | 0.59  | 065081-021          | NA         | 310297            |
| 3.50             | 2.00  | 1.85         | 0.555 | NA                  | NA         | 310321            |
| 3.50             | 2.00  | 2.170        | 0.84  | NA                  | NA         | 813128*           |
| 3.50             | 2.00  | 2.170        | 0.84  | 055002-027          | NA         | 813129            |
| <b>3.75 O.D.</b> |       |              |       |                     |            |                   |
| 3.75             | 1.75  | 1.653        | 0.61  | NA                  | NA         | 310232*           |
| <b>3.94 O.D.</b> |       |              |       |                     |            |                   |
| 3.94             | 2.01  | 1.850        | NA    | 805494              | NA         | 806807            |
| <b>4.00 O.D.</b> |       |              |       |                     |            |                   |
| 4.00             | 1.75  | 2.440        | 0.81  | NA                  | NA         | 310298            |

**Note:** You need to add the compound part number to the base number listed above. See compounds listed on page 11.03 for the dash number. Complete part number format is XXXXXX-XXX.



4.00 O.D. Continued ▶

# Polyurethane Wheels by Size

Continued ▶

\* Indicates assemblies; † Add -88 after compound number for assembly; Δ add-66 after compound number for sealed assembly; +> add -77 after compound for shoulder bearing assembly

4.00 O.D. Continued

| O.D.             | Tread Width | I.D.  | Bearing Bore Depth | Bearing Ball or Cup | Cone       | Crown Part Number |
|------------------|-------------|-------|--------------------|---------------------|------------|-------------------|
| 4.00             | 1.88        | 2.440 | 0.76               | 370182              | NA         | 310108            |
| 4.00             | 1.92        | 1.780 | NA                 | 065136              | 065137     | 310221            |
| 4.00             | 2.00        | 1.575 | 0.58               | 311000-004          | NA         | 310094            |
| 4.00             | 2.00        | 2.047 | 0.59               | 065081-021          | NA         | 081645            |
| 4.00             | 2.00        | 2.047 | 0.59               | NA                  | NA         | 092538*           |
| 4.00             | 2.00        | 2.170 | NA                 | NA                  | NA         | 813081-001*       |
| 4.00             | 2.00        | 2.170 | NA                 | 055002-027          | 813081-200 | 813081-100        |
| 4.00             | 2.00        | 2.440 | Non-Typical        | 311000-013          | NA         | 310176            |
| 4.00             | 2.06        | 1.189 | thru               | 073894              | NA         | 071894            |
| 4.00             | 2.38        | 1.938 | 0.94               | 312000-001          | 312000-008 | 310186            |
| 4.00             | 2.50        | 1.938 | 0.94               | 312000-001          | 312000-008 | 310105            |
| 4.00             | 2.50        | 2.047 | 0.59               | 065081-070          | NA         | 083179†           |
| 4.00             | 2.50        | 2.047 | 0.59               | 065081-070          | NA         | 122893*           |
| 4.00             | 2.50        | 2.047 | 0.59               | 065081-070          | NA         | 310301            |
| 4.00             | 2.50        | 2.047 | 0.68               | NA                  | NA         | 310276            |
| 4.00             | 2.50        | 2.047 | 0.68               | NA                  | NA         | 310376†           |
| 4.00             | 2.50        | 2.047 | 0.68               | NA                  | NA         | 310277*           |
| 4.00             | 2.50        | 2.047 | 0.76               | 065081-021          | NA         | 310114            |
| 4.00             | 2.50        | 2.444 | 0.67               | NA                  | NA         | 310312            |
| 4.00             | 2.63        | 2.440 | 0.77               | 311000-013          | NA         | 310103            |
| 4.00             | 2.75        | 1.780 | 0.72               | 065136              | 065137     | 310193            |
| 4.00             | 2.75        | 1.938 | thru               | NA                  | NA         | 310098            |
| 4.00             | 2.75        | 1.938 | thru               | NA                  | NA         | 310152            |
| 4.00             | 2.75        | 2.047 | 0.59               | 065081-021          | NA         | 310099            |
| 4.00             | 2.75        | 2.440 | 0.84               | 311000-013          | NA         | 310183            |
| 4.00             | 2.88        | 1.850 | 0.575              | NA                  | NA         | 310128            |
| 4.00             | 2.88        | 2.047 | 0.59               | 065081-021          | NA         | 073961            |
| 4.00             | 2.88        | 2.047 | 0.75               | 065081-021          | NA         | 083585†           |
| 4.00             | 2.88        | 2.047 | 0.59               | NA                  | NA         | 091163*           |
| 4.00             | 2.88        | 2.328 | 0.83               | 065105              | 065106     | 310153            |
| 4.00             | 2.88        | 2.440 | 0.672              | NA                  | NA         | 310235            |
| 4.00             | 2.88        | 2.440 | 0.75               | 311000-013          | NA         | 310142            |
| 4.00             | 2.88        | 2.440 | 0.98               | 311000-013          | NA         | 310181            |
| 4.00             | 2.95        | 2.170 | NA                 | NA                  | NA         | 813080-001*       |
| 4.00             | 3.25        | 2.170 | NA                 | NA                  | NA         | 808982-001*       |
| 4.00             | 3.25        | 2.170 | NA                 | NA                  | NA         | 808982-002*       |
| 4.00             | 3.62        | 2.047 | 0.59               | 065081-021          | NA         | 310158            |
| 4.00             | 3.62        | 2.047 | 0.59               | 065081-021          | NA         | 310258            |
| 4.00             | 3.62        | 2.047 | 0.625              | 065081-021          | NA         | 310253            |
| 4.00             | 3.63        | 2.440 | 0.77               | 311000-013          | NA         | 310106            |
| 4.00             | 4.12        | 2.047 | 0.75               | 065081-021          | NA         | 088628†           |
| 4.00             | 5.00        | 2.440 | 0.63               | NA                  | NA         | 084944            |
| <b>4.92 O.D.</b> |             |       |                    |                     |            |                   |
| 4.92             | 2.44        | 2.170 | 0.80               | NA                  | NA         | 813130*           |
| <b>5.00 O.D.</b> |             |       |                    |                     |            |                   |
| 5.00             | 1.13        | 2.047 | Non-Typical        | 065081-021          | NA         | 310168            |
| 5.00             | 1.50        | 0.625 | thru               | NA                  | NA         | 071892*           |
| 5.00             | 1.75        | 2.440 | 0.667              | 311000-007          | NA         | 310360*           |
| 5.00             | 2.00        | 1.188 | thru               | NA                  | NA         | 073325*           |
| 5.00             | 2.00        | 1.850 | 0.551              | NA                  | NA         | 310233*           |
| 5.00             | 2.00        | 2.047 | 0.59               | 065081-021          | NA         | 310159            |
| 5.00             | 2.00        | 2.440 | Non-Typical        | 311000-013          | NA         | 310173            |
| 5.00             | 2.50        | 1.850 | 0.675              | NA                  | NA         | 310126            |
| 5.00             | 2.50        | 1.938 | 0.94               | 312000-001          | 312000-006 | 310139            |
| 5.00             | 2.63        | 2.835 | 0.78               | NA                  | NA         | 310104            |
| 5.00             | 2.88        | 2.047 | 0.63               | 311000-011          | NA         | 310095            |
| 5.00             | 2.88        | 2.047 | 0.59               | 311000-006          | NA         | 310164            |
| 5.00             | 2.88        | 2.328 | 0.83               | 065105              | 065106     | 310151            |
| 5.00             | 2.88        | 2.440 | 0.67               | NA                  | NA         | 310079            |
| 5.00             | 2.88        | 2.440 | 0.83               | 065081-057†         | NA         | 115032†Δ          |
|                  |             |       |                    | 065081-005Δ         |            |                   |
| 5.00             | 2.88        | 2.440 | 0.83               | 365181-057-01       | NA         | 315032+>          |
| 5.00             | 2.88        | 2.440 | 0.78               | 311000-013          | NA         | 310133            |
| 5.00             | 2.88        | 2.440 | 0.75               | 065081-057          | NA         | 310143            |

Note: You need to add the compound part number to the base number listed above. See compounds listed on page 11.03 for the dash number. Complete part number format is XXXXX-XXX.

New part

Continued ▶

| O.D.             | Tread Width | I.D.  | Bearing Bore Depth | Bearing Ball or Cup  | Cone                     | Crown Part Number        |
|------------------|-------------|-------|--------------------|----------------------|--------------------------|--------------------------|
| 5.00             | 2.88        | 3.149 | 0.98               | 065081-008           | NA                       | 083586                   |
| 5.00             | 2.88        | 3.149 | 0.98               | NA                   | NA                       | 113016*                  |
| 5.00             | 2.88        | 3.149 | 0.98               | NA                   | NA                       | 310586                   |
| 5.00             | 3.00        | 1.780 | 0.81               | 065136               | 065137                   | 310195                   |
| 5.00             | 3.00        | 2.834 | 0.74               | 365081-006           | NA                       | 310115                   |
| 5.00             | 3.00        | 3.250 | 1.78               | NA                   | NA                       | 310229                   |
| 5.00             | 3.63        | 2.440 | 0.67               | 065081-057           | NA                       | 310160†                  |
| 5.00             | 3.63        | 2.835 | 0.76               | 365081-006           | NA                       | 310102                   |
| 5.00             | 3.75        | 2.835 | 0.74               | NA                   | NA                       | 310116                   |
| 5.00             | 3.88        | 2.050 | 0.60               | 065081-021           | NA                       | 312360                   |
| 5.00             | 3.88        | 2.440 | 0.67               | NA                   | NA                       | 310234†Δ                 |
| 5.00             | 4.00        | 2.440 | 0.63               | 065081-024           | NA                       | 310259                   |
| 5.00             | 4.12        | 2.440 | 0.83               | 065081-057†          | NA                       | 115033†Δ                 |
|                  |             |       |                    | 065081-005Δ          |                          |                          |
| 5.00             | 4.12        | 2.440 | 0.83               | 365181-057-01        | NA                       | 315033+>                 |
| 5.00             | 4.12        | 3.149 | 0.98               | 065081-008           | NA                       | 083587                   |
| 5.00             | 4.12        | 3.149 | 0.98               | NA                   | NA                       | 113017*                  |
| <b>5.50 O.D.</b> |             |       |                    |                      |                          |                          |
| 5.50             | 2.38        | 2.047 | 0.59               | NA                   | NA                       | 310288                   |
| <b>5.91 O.D.</b> |             |       |                    |                      |                          |                          |
| 5.91             | 2.20        | 1.850 | 0.55               | NA                   | NA                       | 805535                   |
| 5.91             | 2.36        | 2.050 | 0.59               | NA                   | NA                       | 812015*                  |
| 5.91             | 2.36        | NA    | NA                 | NA                   | NA                       | 802745*                  |
| 5.91             | 2.36        | NA    | NA                 | NA                   | NA                       | 804136*                  |
| <b>6.00 O.D.</b> |             |       |                    |                      |                          |                          |
| 6.00             | 2.00        | 2.017 | 0.59               | NA                   | NA                       | 310319                   |
| 6.00             | 2.00        | 2.440 | 0.63               | NA                   | NA                       | 310096                   |
| 6.00             | 2.00        | 2.835 | Non-Typical        | NA                   | NA                       | 310165                   |
| 6.00             | 2.00        | 3.149 | 0.83               | 065081-007           | NA                       | 090748                   |
| 6.00             | 2.00        | 3.149 | 0.83               | NA                   | NA                       | 100956*                  |
| 6.00             | 2.00        | 3.149 | 0.83               | 065081-007           | NA                       | 133762<br>(Low Profile)  |
| 6.00             | 2.00        | 3.149 | 0.83               | NA                   | NA                       | 135067*<br>(Low Profile) |
| 6.00             | 2.40        | 1.980 | 0.88               | 065134               | 065135                   | 310082                   |
| 6.00             | 2.50        | 1.938 | 0.94               | 312000-001           | 312000-006               | 310166                   |
| 6.00             | 2.50        | 2.328 | 1.97               | 065105 and<br>071545 | 065106 and<br>312000-010 | 310161                   |
| 6.00             | 2.75        | 3.149 | 0.83               | 065081-008           | NA                       | 082021†                  |
| 6.00             | 2.75        | 3.149 | 0.83               | 365081-008-02        | NA                       | 382021+>                 |
| 6.00             | 2.75        | 3.149 | 0.83               | 065081-008           | NA                       | 310305                   |
| 6.00             | 2.88        | 3.150 | 0.80               | 065081-008†          | NA                       | 125069†Δ                 |
|                  |             |       |                    | 065081-085Δ          |                          |                          |
| 6.00             | 2.88        | 3.150 | 0.80               | NA                   | NA                       | 310313                   |
| 6.00             | 2.88        | 3.150 | 0.80               | 365081-008-01        | NA                       | 325069+>                 |
| 6.00             | 3.00        | 1.780 | 0.81               | 065136               | 065137                   | 310171                   |
| 6.00             | 3.00        | 1.938 | 0.97               | 065136               | 065137                   | 310196                   |
| 6.00             | 3.00        | 1.969 | NA                 | NA                   | NA                       | 310225                   |
| 6.00             | 3.00        | 2.047 | 0.60               | NA                   | NA                       | 310132                   |
| 6.00             | 3.00        | 2.047 | 0.67               | 065081-021           | NA                       | 310177                   |
| 6.00             | 3.00        | 2.440 | 0.755              | 065081-057           | NA                       | 310324                   |
| 6.00             | 3.00        | 2.440 | 0.78               | 311000-007           | NA                       | 310134                   |
| 6.00             | 3.00        | 2.440 | 0.68               | 311000-007           | NA                       | 310167                   |
| 6.00             | 3.00        | 2.440 | 0.84               | 312000-003           | 312000-011               | 310191                   |
| 6.00             | 3.25        | 2.046 | 0.593              | NA                   | NA                       | 310281                   |
| 6.00             | 3.63        | 2.440 | 0.67               | 311000-007           | NA                       | 310172†                  |
| 6.00             | 3.89        | 3.149 | 0.828              | NA                   | NA                       | 310239                   |
| 6.00             | 3.88        | 2.835 | 0.74               | 365081-006           | NA                       | 310222                   |
| 6.00             | 3.94        | 2.875 | 1.22               | 312000-004           | 312000-012               | 310154                   |
| 6.00             | 4.00        | 2.835 | 1.17               | NA                   | NA                       | 310109                   |
| 6.00             | 4.00        | 2.835 | 0.67               | NA                   | NA                       | 310169                   |
| 6.00             | 4.12        | 3.149 | 0.98               | 065081-008†          | NA                       | 125070†Δ                 |
|                  |             |       |                    | 065081-085Δ          |                          |                          |
| 6.00             | 4.12        | 3.149 | 0.98               | 365081-008-01        | NA                       | 325070+>                 |
| 6.00             | 4.25        | 3.149 | 0.83               | 065081-008           | NA                       | 082020†                  |
| 6.00             | 4.25        | 3.149 | 0.83               | 365081-008-01        | NA                       | 382020+>                 |

**WHEELS AND TIRES**

## Polyurethane Wheels by Size

## Non-Polyurethane Wheels by Size

\* Indicates assemblies; ‡ Add -88 after compound number for assembly; Δ add-66 after compound number for sealed assembly; +> add -77 after compound for shoulder bearing assembly

| O.D.              | Tread Width | I.D.  | Bearing Bore Depth | Bearing Ball or Cup | Cone       | Crown Part Number |
|-------------------|-------------|-------|--------------------|---------------------|------------|-------------------|
| <b>6.88 O.D.</b>  |             |       |                    |                     |            |                   |
| 6.88              | 2.00        | 2.835 | 0.97               | NA                  | NA         | 310163            |
| <b>7.00 O.D.</b>  |             |       |                    |                     |            |                   |
| 7.00              | 1.95        | 1.845 | 0.55               | 065081-020          | NA         | 120737            |
| 7.00              | 1.95        | 1.845 | 0.55               | NA                  | NA         | 120739*           |
| 7.00              | 2.00        | 1.850 | NA                 | NA                  | NA         | 314496            |
| 7.00              | 2.00        | 1.850 | 0.55               | NA                  | NA         | 044495*           |
| 7.00              | 2.00        | 1.850 | 0.55               | 065081-020          | NA         | 044496            |
| 7.00              | 2.50        | 2.326 | Non-Typical        | 065105              | 065106     | 310155            |
| 7.00              | 2.50        | 2.328 | Non-Typical        | 065105              | 065106     | 310107            |
| 7.00              | 2.75        | 1.980 | NA                 | 065134              | 065135     | 310227            |
| 7.00              | 2.86        | 2.047 | Non-Typical        | 065081-021          | NA         | 310087            |
| 7.00              | 3.00        | 2.047 | 0.75               |                     |            | 310287‡           |
| 7.00              | 4.00        | 2.440 | 0.63               | NA                  | NA         | 310292*           |
| 7.00              | 4.00        | 2.440 | 0.84               | 312000-003          | 312000-011 | 310192            |
| 7.00              | 5.00        | 2.562 | NA                 | NA                  | NA         | 093442            |
| <b>7.09 O.D.</b>  |             |       |                    |                     |            |                   |
| 7.09              | 1.97        | 1.850 | 0.55               | 065081-018          | NA         | 818275-101*       |
| 7.09              | 1.97        | 1.850 | 0.55               | 055002-023          | NA         | 818275-201*       |
| 7.09              | 1.97        | 1.850 | 0.55               | 065081-020          | NA         | 818270            |
| <b>7.50 O.D.</b>  |             |       |                    |                     |            |                   |
| 7.50              | 2.13        | 2.677 | 2.185              | NA                  | NA         | 310299            |
| <b>7.87 O.D.</b>  |             |       |                    |                     |            |                   |
| 7.87              | 2.00        | 1.85  | NA                 | NA                  | NA         | 041269            |
| <b>7.88 O.D.</b>  |             |       |                    |                     |            |                   |
| 7.88              | 2.48        | 2.047 | Non-Typical        | 065081-021          | NA         | 310091            |
| <b>8.00 O.D.</b>  |             |       |                    |                     |            |                   |
| 8.00              | 2.00        | 1.750 | NA                 | NA                  | NA         | 310089            |
| 8.00              | 2.00        | 1.980 | 0.81               | 065134              | 065135     | 310148            |
| 8.00              | 2.00        | 1.998 | thru               | NA                  | NA         | 310097            |
| 8.00              | 2.00        | 2.047 | 0.60               | 065081-021          | NA         | 310090            |
| 8.00              | 2.00        | 2.047 | 0.67               | 065081-021          | NA         | 310092            |
| 8.00              | 2.00        |       | NA                 | NA                  | NA         | 082274-001*       |
| 8.00              | 2.00        | 2.044 | NA                 | 065081-021          | NA         | 083834-001        |
| 8.00              | 2.00        | 2.438 |                    | 065081-025          | NA         | 083834-002        |
| 8.00              | 2.50        | 7.600 | 2.64               | NA                  | NA         | 310130            |
| 8.00              | 3.75        | 3.150 | 0.83               | 065081-008          | NA         | 080915‡           |
| 8.00              | 4.00        | 2.440 | 0.66               | 065081-025          | NA         | 310179‡           |
| 8.00              | 4.00        | 2.835 | 0.91               | 065081-067          | NA         | 127723‡           |
| <b>8.50 O.D.</b>  |             |       |                    |                     |            |                   |
| 8.50              | 2.66        | 2.754 | Non-Typical        | NA                  | NA         | 310131            |
| 8.50              | 2.69        | 2.754 | 2.5                | NA                  | NA         | 310129            |
| 8.50              | 2.69        | 2.760 | Non-Typical        | 065081-031          | NA         | 132359            |
| <b>9.00 O.D.</b>  |             |       |                    |                     |            |                   |
| 9.00              | 5.00        | 3.543 | 0.79               | NA                  | NA         | 310117            |
| <b>10.00 O.D.</b> |             |       |                    |                     |            |                   |
| 10.00             | 3.00        | 2.325 | NA                 | NA                  | NA         | 311520            |
| 10.00             | 3.00        | 2.325 | NA                 | NA                  | NA         | 311521*           |
| 10.00             | 3.00        | 2.325 | NA                 | NA                  | NA         | 081520*           |
| <b>11.22 O.D.</b> |             |       |                    |                     |            |                   |
| 11.22             | 3.94        |       |                    |                     |            | 810574-001        |
| <b>13.00 O.D.</b> |             |       |                    |                     |            |                   |
| 13.00             | 3.94        | 2.950 | 1.38               | NA                  | NA         | 807544            |
| 13.00             | 3.94        | 2.950 | NA                 | NA                  | NA         | 810583            |
| 13.00             | 3.94        | 2.950 | NA                 | NA                  | NA         | 810601*           |
| <b>14.25 O.D.</b> |             |       |                    |                     |            |                   |
| 14.25             | 8.00        | 9.980 | NA                 | NA                  | NA         | 133753            |

| O.D.             | Tread Width | I.D.  | Bearing Bore Depth | Bearing Ball | Type     | Crown Part Number |
|------------------|-------------|-------|--------------------|--------------|----------|-------------------|
| <b>2.88 O.D.</b> |             |       |                    |              |          |                   |
| 2.88             | 2.06        | 1.189 | thru               | NA           | Steel    | 072426*           |
| 2.88             | 2.06        |       | NA                 | NA           | Steel    | 104633            |
| <b>2.90 O.D.</b> |             |       |                    |              |          |                   |
| 2.90             | 3.88        | 1.850 | 0.55               | 065081-019   | Nylon    | 044508            |
| <b>2.91 O.D.</b> |             |       |                    |              |          |                   |
| 2.91             | 3.84        | 1.850 | 0.56               | 065081-019   | Steel    | 120738            |
| 2.91             | 3.84        | 1.850 | 0.56               | NA           | Steel    | 120740*           |
| 2.91             | 3.86        | 1.850 | 0.55               | NA           | Nylon    | 044506-102*       |
| <b>3.25 O.D.</b> |             |       |                    |              |          |                   |
| 3.25             | 3.25        | 2.047 | 0.59               | 065081-021   | Steel    | 082742            |
| 3.25             | 3.25        | 2.047 | 0.59               | 065081-021   | Nylon    | 082740            |
| 3.25             | 3.88        | 1.849 | 0.63               | NA           | Nylon    | 082283-002*       |
| 3.25             | 3.88        | 1.849 | 0.63               | NA           | Steel    | 082283-003*       |
| 3.25             | 3.88        | 1.849 | 0.63               | 065081-020   | Nylon    | 082285            |
| 3.25             | 3.88        | 1.849 | 0.63               | 065081-020   | Steel    | 082286            |
| 3.25             | 4.50        | 2.440 | 0.66               | 065081-025   | Nylon    | 083968            |
| 3.25             | 4.50        | 2.440 | 0.66               | 065081-025   | Steel    | 083969            |
| 3.25             | 5.00        | 2.047 | 0.63               | 065081-021   | Steel    | 082743            |
| <b>4.00 O.D.</b> |             |       |                    |              |          |                   |
| 4.00             | 2.06        | 1.189 | thru               | NA           | Steel    | 071426            |
| 4.00             | 2.06        | 1.189 | thru               | NA           | Phenolic | 071893            |
| 4.00             | 2.06        | 1.189 | thru               | NA           | Phenolic | 073895            |
| <b>5.00 O.D.</b> |             |       |                    |              |          |                   |
| 5.00             | 1.62        | 0.750 | thru               | NA           | Steel    | 071916*           |
| 5.00             | 2.00        | 1.188 | thru               | NA           | Phenolic | 073324*           |
| 5.00             | 2.12        | 0.750 | thru               | NA           | Phenolic | 071891            |
| 5.00             | 2.12        | 0.750 | thru               | NA           | Steel    | 073602*           |
| <b>7.00 O.D.</b> |             |       |                    |              |          |                   |
| 7.00             | 2.00        | 1.850 | 0.55               | 065081-020   | Nylon    | 044497            |
| 7.00             | 2.00        | 1.850 | 0.55               | 065081-020   | Rubber   | 044498            |
| 7.00             | 5.00        | 3.150 | thru               | NA           | Rubber   | 077533*           |
| 7.00             | 5.00        |       | NA                 | NA           | Rubber   | 083167            |
| <b>7.09 O.D.</b> |             |       |                    |              |          |                   |
| 7.09             | 1.97        | 1.85  | 0.55               | 065081-020   | Nylon    | 818271            |
| 7.09             | 1.97        | 1.85  | 0.55               | 065081-018   | Nylon    | 818275-102*       |
| 7.09             | 1.97        | 1.85  | 0.55               | 055002-023   | Nylon    | 818275-202*       |
| 7.09             | 1.97        | 1.85  | 0.55               | 065081-018   | Rubber   | 818275-103*       |
| 7.09             | 1.97        | 1.85  | 0.55               | 055002-023   | Rubber   | 818275-203*       |

**Note:** You need to add the compound part number to the base number listed above. See compounds listed on page 11.03 for the dash number. Complete part number format is XXXXXX-XXX.



**Casters for use in a wide range of industries.** Commonly found on platform trucks, shop carts and industrial equipment.

- Durable
- Phenolic
- Provides floor protection
- Swivel and Rigid Options
- Not recommended for use in wet environments

### Standard and Economy Casters

| Wheel    | Wheel Size | Type   | Overall Height | Capacity   | Standard Caster ASM Part Number | Economy Caster ASM Part Number | Wheel Only** Part Number |
|----------|------------|--------|----------------|------------|---------------------------------|--------------------------------|--------------------------|
| Phenolic | 4" x 2"    | Swivel | 5.625"         | 800 lbs.   | 310330-041                      | 310329-041                     | 310331-040               |
|          |            | Rigid  | 5.625"         | 800 lbs.   | 310330-042                      | 310329-042                     |                          |
|          | 5" x 2"    | Swivel | 6.5"           | 1,000 lbs. | 310330-051                      | 310329-051                     | 310331-050               |
|          |            | Rigid  | 6.5"           | 1,000 lbs. | 310330-052                      | 310329-052                     |                          |
|          | 6" x 2"    | Swivel | 7.25" or 7.5"  | 1,200 lbs. | 310330                          | 310329*                        | 310331                   |
|          |            | Rigid  | 7.25" or 7.5"  | 1,200 lbs. | 310330-062                      | 310329-062*                    |                          |
|          | 8" x 2"    | Swivel | 9.5"           | 1,250 lbs. | 310330-081                      | 310329-081                     | 310331-080               |
|          |            | Rigid  | 9.5"           | 1,250 lbs. | 310330-082                      | 310329-082                     |                          |

\*Caster Height 7.5"

\*\*Phenolic Wheel w/Roller Bearing/Spanner Bushing (1/2" ID)



310330-041



310329-052



310329



310330-082



| Description             | Part Number |
|-------------------------|-------------|
| Axle for Casters/Wheels | 310331-000  |

# Pallet Truck - One Source Casters

## Features

- 3 simple designs fit most manufacturers' pallet trucks.
- Poly-block creates a dampening effect to eliminate rocking and provide greater stability.
- Adjustable height eliminates the need for spacer plates and shims.

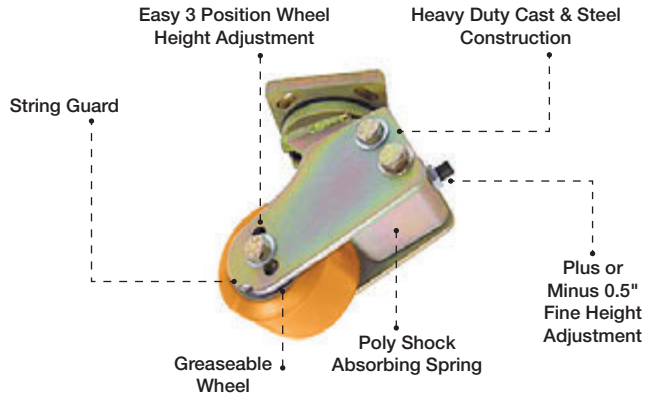

## Replacement Parts

| Part Number | Description         | Bearing    |
|-------------|---------------------|------------|
| 310126-306  | Wheel               | 065081-020 |
| 310276-306  | Wheel               | 065081-021 |
| 310281-204  | Wheel               | 311000-021 |
| 310281-306  | Wheel               | 311000-021 |
| 310376-306  | Wheel               | 065081-021 |
| 310376-102  | Wheel-Non Greasable | 065081-021 |
| 310376-204  | Wheel-Non Greasable | 065081-021 |
| 310376-306  | Wheel-Non Greasable | 065081-021 |

310277-306\* Wheel Assembly  
 \*Includes Wheel 310276-306, Bearings, String Guards, Spacers and Bushing

|             |                       |    |
|-------------|-----------------------|----|
| 310278*     | Axle Kit              | NA |
| 310278-001* | Axle Kit Food Service | NA |

#Includes Wheel Axle Bolt, Washers, Nuts, and Height Adjustment Screw

**WARNING:** Cancer and reproductive harm - [www.P65Warnings.ca.gov](http://www.P65Warnings.ca.gov)

## One Source Assembly Casters

| Part Number   | Vendor Number  | Wheel Number | Asm. Caster Height | Turning Radius | Centered or Offset Swivel | Load Wheel Size | Base Plate Size | Slots or Holes  | Bolt Pattern                |
|---------------|----------------|--------------|--------------------|----------------|---------------------------|-----------------|-----------------|-----------------|-----------------------------|
| 310273-102    | STR2000        | 310376-102   | 7.5                | 4.1875         | Centered                  | 4x2.5           | 4x4.75          | Slots           | 3.004x3.992 and 2.287x3.275 |
| 310273-204    | STR2000        | 310376-204   | 7.5                | 4.1875         | Centered                  | 4x2.5           | 4x4.75          | Slots           | 3.004x3.992 and 2.287x3.275 |
| 310273-306    | STR2000FS*     | 310376-306   | 7.5                | 4.1875         | Centered                  | 4x2.5           | 4x4.75          | Slots           | 3.004x3.992 and 2.287x3.275 |
| 310273-102-CR | STR2000CR2     | 310376-102   | 7.5                | 4.1875         | Centered                  | 4x2.5           | 5x5             | 2-sets of Holes | 2.625x3.625 and 4.125x4.125 |
| 310273-204-CR | STR2000CR2     | 310376-204   | 7.5                | 4.1875         | Centered                  | 4x2.5           | 5x5             | 2-sets of Holes | 2.625x3.625 and 4.125x4.125 |
| 310273-306-CR | STR2000CR2 FS* | 310376-306   | 7.5                | 4.1875         | Centered                  | 4x2.5           | 5x5             | 2-sets of Holes | 2.625x3.625 and 4.125x4.125 |
| 310273-306-BL | STR2001BL FS*  | 310376-306   | 7.5                | 3.875          | Centered                  | 4x2.5           | 4x4.75          | Holes           | 2.756x3.386                 |
| 310273-306-CT | STR2000TY FS*  | 310376-306   | 7.5                | 4.1875         | Centered                  | 4x2.5           | 4x5.75          | Holes           | 3x5                         |
| 310273-306-HY | STR2000HY FS*  | 310376-306   | 7.5                | 4.1875         | Centered                  | 4x2.5           | 4x4.50          | Threaded Holes  | 2.795x3.295                 |
| 310273-102-RA | STR2000RA      | 310376-102   | 7.625              | 4.1875         | Offset                    | 4x2.5           | 5x6             | Slots           | 3x5 and 2.625x4.5           |
| 310273-204-RA | STR2000RA      | 310376-204   | 7.625              | 4.1875         | Offset                    | 4x2.5           | 5x6             | Slots           | 3x5 and 2.625x4.5           |
| 310273-306-RA | STR2000RA FS*  | 310376-306   | 7.625              | 4.1875         | Offset                    | 4x2.5           | 5x6             | Slots           | 3x5 and 2.625x4.5           |
| 310274-102    | STR3000        | 310376-102   | 9.125              | 4.1875         | Centered                  | 4x2.5           | 5x7             | Slots           | 3.328x5.269 and 2.731x4.672 |
| 310274-204    | STR3000        | 310376-204   | 9.125              | 4.1875         | Centered                  | 4x2.5           | 5x7             | Slots           | 3.328x5.269 and 2.731x4.672 |
| 310274-306    | STR3000 FS*    | 310376-306   | 9.125              | 4.1875         | Centered                  | 4x2.5           | 5x7             | Slots           | 3.328x5.269 and 2.731x4.672 |
| 310275-102    | STR4001        | 310376-102   | 8.375              | 4.1875         | Centered                  | 4x2.5           | 5x5.375         | Holes           | 4x4                         |
| 310275-204    | STR4001        | 310376-204   | 8.375              | 4.1875         | Centered                  | 4x2.5           | 5x5.375         | Holes           | 4x4                         |
| 310275-306    | STR4001 FS*    | 310376-306   | 8.375              | 4.1875         | Centered                  | 4x2.5           | 5x5.375         | Holes           | 4x4                         |
| 310260-204-BR | STR4163        | 310324-xxx   | 8                  | 4.684          | Offset                    | 6x3             | 6.25x4.5        | Holes           | 5.25x3.375                  |
| 310260-306-BR | STR4164        | 310324-xxx   | 8                  | 4.684          | Offset                    | 6x3             | 6.25x4.5        | Holes           | 5.25x3.375                  |
| 310261-102-YT | STR1513        | 310325-xxx   | 5.5                | 2.944          | Offset                    | 2.75x2          | 4.803x3.15      | Threaded Holes  | 2x1.732                     |
| 310262-306-RA | STR3200FS*     | 310376-306   | 7.5                | 4.1875         | Centered                  | 4x2.5           | 5x7             | Slots           | 3.328x5.269 and 2.731x4.672 |
| 310279-306-BR | STR6110FS*     | 310126-xxx   | 9.875              | 4.25           | Centered                  | 5x2.5           | 6.25x4.5        | Slots           | 5.25x3.375 and 4.938x2.438  |
| 310289-306    | STR5263FS*     | 310376-xxx   | 8.85               | 4.44           | Centered                  | 4x2.5           | 5x7             | Holes           | 5.25x3.375                  |
| 310265-102    | STR5453        | 310376-xxx   | 7.51               | 4.213          | Centered                  | 4x2.5           | 5.25x5.5        | Holes           | 4.125x4.125 and 2.625x3.625 |

\*All -306 Assemblies come with a greaseable pivot and wheel axle that are made to withstand extreme wash down applications as a Food Service option.

**Note:** See cross references on next page.

## Pallet Truck - One Source Casters Manufacturer Cross Reference

| Crown Number  | OE Number   | OEM Name            |
|---------------|-------------|---------------------|
| 310274-xxx    | 4972078     | Allis Chalmers/Tusk |
| 310274-xxx    | 74970278    | Allis Chalmers/Tusk |
| 310273-xxx    | 127520      | Baker               |
| 310273-xxx    | 138071      | Baker               |
| 310273-xxx    | 138073      | Baker               |
| 310273-xxx    | 138075      | Baker               |
| 310273-xxx    | 139312      | Baker               |
| 310273-xxx    | 152865      | Baker               |
| 310273-xxx    | 153858      | Baker               |
| 310273-xxx    | 993465      | Baker               |
| 310273-xxx    | 993994      | Baker               |
| 310279-306-BR | 27835-003   | Barrett             |
| 310279-306-BR | 37194-003S  | Barrett             |
| 310279-306-BR | 37194-006   | Barrett             |
| 310274-xxx    | 43380-FS000 | Barrett             |
| 310274-xxx    | 43380-FS001 | Barrett             |
| 310274-xxx    | 43380-FS002 | Barrett             |
| 310289-306    | 43380-FS004 | Barrett             |
| 310260-xxx-BR | 43380-FS400 | Barrett             |
| 310273-306-CT | 217384      | Caterpillar         |
| 310273-xxx    | 1009237     | Caterpillar         |
| 310273-xxx    | 1009299     | Caterpillar         |
| 310273-xxx    | 1202032     | Caterpillar         |
| 310261-xxx-YT | A0000-21149 | Caterpillar         |
| 310273-306-CT | NA014895    | Caterpillar         |
| 310275-xxx    | 1779711     | Clark               |
| 310275-xxx    | 2314632     | Clark               |
| 310275-xxx    | 2314636     | Clark               |
| 310275-xxx    | 2743452     | Clark               |
| 310275-xxx    | 2779621     | Clark               |
| 310275-xxx    | 2786022     | Clark               |
| 310273-xxx    | 323772      | Hyster              |
| 310273-306-HY | 346201      | Hyster              |
| 310273-xxx    | 346202      | Hyster              |
| 310273-xxx    | 351314      | Hyster              |
| 310273-xxx    | 826120      | Hyster              |
| 310273-xxx    | 826275      | Hyster              |
| 310273-xxx    | 2007884     | Hyster              |
| 310261-xxx-YT | 2044852     | Hyster              |
| 310273-306-HY | 2079240     | Hyster              |
| 310274-xxx    | 2308415     | Hyster              |

| Crown Number  | OE Number      | OEM Name    |
|---------------|----------------|-------------|
| 310273-xxx    | 3246410        | Hyster      |
| 310273-xxx    | LC2000         | Larcaster   |
| 310273-xxx-CR | LC2400         | Larcaster   |
| 310273-xxx    | LC2500         | Larcaster   |
| 310274-xxx    | LC3001         | Larcaster   |
| 310274-xxx    | LC3501         | Larcaster   |
| 310275-xxx    | LC4001         | Larcaster   |
| 310275-xxx    | LC4501         | Larcaster   |
| 310273-306-BL | 154148         | Linde/Baker |
| 310273-xxx    | NA067022       | Mitubishi   |
| 310261-xxx-YT | A0000-21149    | Mitubishi   |
| 310289-306    | 43380-FS004    | Nissan      |
| 310273-xxx    | 27332          | Prime Mover |
| 310273-xxx    | 27675          | Prime Mover |
| 310273-xxx    | 27849          | Prime Mover |
| 310273-xxx    | 139312         | Prime Mover |
| 310273-xxx-RA | 1082408        | Raymond     |
| 310273-xxx-RA | 59048553       | Raymond     |
| 310262-306-RA | 671-012        | Raymond     |
| 310273-xxx    | 671-017        | Raymond     |
| 310273-xxx    | 671-023        | Raymond     |
| 310273-xxx    | 671-024        | Raymond     |
| 310273-xxx    | 671-025        | Raymond     |
| 310273-xxx    | 671-026        | Raymond     |
| 310273-xxx-RA | 671-042        | Raymond     |
| 310273-xxx    | 0951-C01       | RVI         |
| 310273-xxx    | 00590-00027-71 | Toyota      |
| 310274-xxx    | 00590-01556-71 | Toyota      |
| 310274-xxx    | 00590-01662-71 | Toyota      |
| 310274-xxx    | 00590-39633-71 | Toyota      |
| 310273-xxx    | 42660-81100-71 | Toyota      |
| 310273-xxx    | 150120033      | Yale        |
| 310274-xxx    | 516012603      | Yale        |
| 310274-xxx    | 518782600      | Yale        |
| 310274-xxx    | 520583002      | Yale        |
| 310274-xxx    | 524153612      | Yale        |
| 310273-306-HY | 524244220      | Yale        |
| 310273-306-HY | 524267533      | Yale        |
| 310261-xxx-YT | 580023164      | Yale        |
| 310274-xxx    | 720465006      | Yale        |

## Load Wheel Assemblies w/Shoulder Bearings

| Crown Assembly Part Number | O.D. | Tread Width | I.D.  | Bearing Bore Depth | Bearings      | Load Wheel |
|----------------------------|------|-------------|-------|--------------------|---------------|------------|
| 315032-302-77              | 5.00 | 2.88        | 2.44  | 0.83               | 365181-057-01 | 115032-302 |
| 315032-305-77              | 5.00 | 2.88        | 2.44  | 0.83               | 365181-057-01 | 115032-305 |
| 315032-306-77              | 5.00 | 2.88        | 2.44  | 0.83               | 365181-057-01 | 115032-306 |
| 315032-401-77              | 5.00 | 2.88        | 2.44  | 0.83               | 365181-057-01 | 115032-401 |
| 315033-302-77              | 5.00 | 4.12        | 2.44  | 0.83               | 365181-057-01 | 115033-302 |
| 315033-305-77              | 5.00 | 4.12        | 2.44  | 0.83               | 365181-057-01 | 115033-305 |
| 315033-306-77              | 5.00 | 4.12        | 2.44  | 0.83               | 365181-057-01 | 115033-306 |
| 315033-401-77              | 5.00 | 4.12        | 2.44  | 0.83               | 365181-057-01 | 115033-401 |
| 325070-302-77              | 6.00 | 4.12        | 3.149 | 0.98               | 365081-008-01 | 125070-302 |
| 325070-305-77              | 6.00 | 4.12        | 3.149 | 0.98               | 365081-008-01 | 125070-305 |
| 325070-401-77              | 6.00 | 4.12        | 3.149 | 0.98               | 365081-008-01 | 125070-401 |
| 325069-201-77              | 6.00 | 2.88        | 3.149 | 0.80               | 365081-008-01 | 125069-201 |
| 325069-301-77              | 6.00 | 2.88        | 3.149 | 0.80               | 365081-008-01 | 125069-301 |
| 325069-302-77              | 6.00 | 2.88        | 3.149 | 0.80               | 365081-008-01 | 125069-302 |
| 325069-305-77              | 6.00 | 2.88        | 3.149 | 0.80               | 365081-008-01 | 125069-305 |
| 325069-306-77              | 6.00 | 2.88        | 3.149 | 0.80               | 365081-008-01 | 125069-306 |
| 325069-401-77              | 6.00 | 2.88        | 3.149 | 0.80               | 365081-008-01 | 125069-401 |
| 382021-201-77              | 6.00 | 2.75        | 3.149 | 0.83               | 365081-008-02 | 082021-201 |
| 382021-301-77              | 6.00 | 2.75        | 3.149 | 0.83               | 365081-008-02 | 082021-301 |
| 382021-302-77              | 6.00 | 2.75        | 3.149 | 0.83               | 365081-008-02 | 082021-302 |
| 382021-305-77              | 6.00 | 2.75        | 3.149 | 0.83               | 365081-008-02 | 082021-305 |
| 382021-306-77              | 6.00 | 2.75        | 3.149 | 0.83               | 365081-008-02 | 082021-306 |
| 382021-401-77              | 6.00 | 2.75        | 3.149 | 0.83               | 365081-008-02 | 082021-401 |
| 382020-201-77              | 6.00 | 4.25        | 3.149 | 0.83               | 365081-008-02 | 082020-201 |
| 382020-302-77              | 6.00 | 4.25        | 3.149 | 0.83               | 365081-008-02 | 082020-302 |
| 382020-306-77              | 6.00 | 4.25        | 3.149 | 0.83               | 365081-008-02 | 082020-306 |



- Reduce or eliminate the spacers needed for installation.
- Reduce labor time and costs.

## Quick Change Load Wheel

### Reach Truck Quick Change Load Wheel Kits

Replace a set of load wheels in 2-3 minutes anywhere in your facility.

- Increase truck uptime
- Reduce maintenance labor expense
- No jack required



#### Quick Change Outrigger Kit

| Part Number | Size   | Note   | Bearing    |
|-------------|--------|--|------------|
| 151701-301  | 5x2.88 | 115032-301-66 load wheel assemblies included | 065081-005 |
| 151702-302  | 5x4.12 | 115033-302-66 load wheel assemblies included | 065081-005 |
| 151703-301  | 6x2.88 | 125069-301-66 load wheel assemblies included | 065081-085 |
| 151704-302  | 6x4.12 | 125070-302-66 load wheel assemblies included | 065081-085 |

Your truck must already have standard bolt on outriggers to install this kit.

**WARNING:** Cancer - [www.P65Warnings.ca.gov](http://www.P65Warnings.ca.gov)



#### Quick Change Load Wheel Spare Kit Assembly (less outriggers)

| Part Number | Size   | Note   | Bearing    |
|-------------|--------|--|------------|
| 151705-301  | 5x2.88 | 115032-301-66 load wheel assemblies included | 065081-005 |
| 151706-302  | 5x4.12 | 115033-302-66 load wheel assemblies included | 065081-005 |
| 151707-301  | 6x2.88 | 125069-301-66 load wheel assemblies included | 065081-085 |
| 151708-302  | 6x4.12 | 125070-302-66 load wheel assemblies included | 065081-085 |

**WARNING:** Cancer - [www.P65Warnings.ca.gov](http://www.P65Warnings.ca.gov)



Your truck must have quick change outriggers installed to use this kit.

#### Quick Change Load Wheel Installation Tool

| Part Number | Size  |
|-------------|-------|
| 150192      | 2.88" |
| 150193      | 4.12" |

**Notes:** Each kit is for a complete truck assembly (both sides). Order Wheel Part numbers that end in -66 for the wheel assemblies with sealed bearings. See "Polyurethane Wheels by Size" for other load wheel compound options.



## Triple Load Wheels

**YOUR FLAT SPOTTING SOLUTION**



**NEW!**

Independent wheel rotation to reduce coning and increase load wheel life

### Crown Three Wheel Kit

| Part Number   | Description                      | Note                            |
|---------------|----------------------------------|---------------------------------|
| 154840-101    | Wheel 3.25x2x2.047x0.59          | Wheel Only                      |
| 154840-201    | Wheel 3.25x2x2.047x0.59          | Wheel Only                      |
| 154840-205    | Wheel 3.25x2x2.047x0.59          | Wheel Only                      |
| 154840-301    | Wheel 3.25x2x2.047x0.59          | Wheel Only                      |
| 154840-302    | Wheel 3.25x2x2.047x0.59          | Wheel Only                      |
| 154840-305    | Wheel 3.25x2x2.047x0.59          | Wheel Only                      |
| 154840-306    | Wheel 3.25x2x2.047x0.59          | Wheel Only                      |
| 154840-401    | Wheel 3.25x2x2.047x0.59          | Wheel Only                      |
| 154840-101-88 | Wheel Assembly 3.25x2x2.047x0.59 | Wheel and Bearings - greaseable |
| 154840-201-88 | Wheel Assembly 3.25x2x2.047x0.59 | Wheel and Bearings - greaseable |
| 154840-205-88 | Wheel Assembly 3.25x2x2.047x0.59 | Wheel and Bearings - greaseable |
| 154840-301-88 | Wheel Assembly 3.25x2x2.047x0.59 | Wheel and Bearings - greaseable |
| 154840-302-88 | Wheel Assembly 3.25x2x2.047x0.59 | Wheel and Bearings - greaseable |
| 154840-305-88 | Wheel Assembly 3.25x2x2.047x0.59 | Wheel and Bearings - greaseable |
| 154840-306-88 | Wheel Assembly 3.25x2x2.047x0.59 | Wheel and Bearings - greaseable |
| 154840-401-88 | Wheel Assembly 3.25x2x2.047x0.59 | Wheel and Bearings - greaseable |
| 154838        | Triple Load Wheel Axle           | Axle with 3 holes               |

### Raymond 939-WHL Three Wheel Kit

| Part Number      | Description                    | Note                                     |
|------------------|--------------------------------|--|
| 310250-101       | Wheel 3.25x1.88x2.047x0.595    | Wheel Only                               |
| 310250-102       | Wheel 3.25x1.88x2.047x0.591    | Wheel Only                               |
| 310250-204       | Wheel 3.25x1.88x2.047x0.591    | Wheel Only                               |
| 310250-205       | Wheel 3.25x1.88x2.047x0.595    | Wheel Only                               |
| 310250-301       | Wheel 3.25x1.88x2.047x0.595    | Wheel Only                               |
| 310250-302       | Wheel 3.25x1.88x2.047x0.588    | Wheel Only                               |
| 310250-305       | Wheel 3.25x1.88x2.047x0.595    | Wheel Only                               |
| 310250-306       | Wheel 3.25x1.88x2.047x0.591    | Wheel Only                               |
| 310250-301-INNER | Wheel 3.25x1.88x2.047x0.595 I  | 1 inner wheel with bearings - greaseless |
| 310250-301-OUTER | Wheel 3.25x1.88x2.047x0.595 O  | 1 outer wheel with bearings - greaseless |
| 310250-301-KIT   | Wheel 3.25x1.88x2.047x0.595    | 3 wheels, all bearings - greaseless      |
| 310250-302-KIT   | Wheel 3.25x1.88x2.047x0.588    | 3 wheels, all bearings - greaseable      |
| 310250-302-KITGL | Wheel 3.25x1.88x2.047x0.588 GL | 3 wheels, all bearings - greaseless      |
| 310250-306-KIT   | Wheel 3.25x1.88x2.047x0.591    | 3 wheels, all bearings - greaseable      |
| 310250-306-KITGL | Wheel 3.25x1.88x2.047x0.591 GL | 3 wheels, all bearings - greaseless      |
| 310250-409-KIT   | Wheel 3.25x1.88x2.047x0.595    | 3 wheels, all bearings - greaseable      |
| 370119           | Triple Load Wheel Axle         | Axle with 3 holes                        |

## Dual Tandem Load Wheels



H47531-502

### Dual Tandem Load Wheels PC, PE, PR & PW (9" & 10" forks only)

| Part Number   | Description                         | Note                            |
|---------------|-------------------------------------|---------------------------------|
| 310468-301    | Wheel 3.25x2.44x2.047x.594          | Wheel only                      |
| 310468-302    | Wheel 3.25x2.44x2.047x.594          | Wheel only                      |
| 310468-401    | Wheel 3.25x2.44x2.047x.594          | Wheel only                      |
| 310468-302-88 | Wheel Assembly 3.25x2.44x2.047x.594 | Wheel and Bearings - greaseable |
| 310468-401-88 | Wheel Assembly 3.25x2.44x2.047x.594 | Wheel and Bearings - greaseable |
| H47531-502    | Dual Tandem Wheel Axle              | Axle with 2 Holes               |

**Manual Pallet Jack  
Pre-packaged Wheel Kits**



| Brand             | Model                                    | Load Wheel Kit Part Number** | Load Wheels OD x W | Complete Wheel Kit Part Number** | Steer Wheels OD x W |
|-------------------|--|------------------------------|--------------------|----------------------------------|---------------------|
| American Lifts    | Little Mule                              | 310700-120-KIT*              | 3" x 2.50"         | 310701-120-KIT*                  | 7" x 2"             |
| Atlas             | EZ                                       | 310700-143-KIT*              | 2.75" x 3.75"      | 310701-107-KIT*                  | 7" x 2"             |
|                   | EZV                                      | 310700-119-KIT*              | 3" x 3.70"         | 310701-121-KIT*                  | 7" x 2"             |
|                   | Zenith (Type 9)                          | 310700-119-KIT*              | 3" x 3.70"         | 310701-121-KIT*                  | 7" x 2"             |
| Big Joe           | ALT50                                    | 310700-119-KIT*              | 3" x 3.70"         | 310701-121-KIT*                  | 7" x 2"             |
| Bishamon          | BS55                                     | 310700-134-KIT*              | 2.75" x 3.75"      |                                  |                     |
| BT                | L2000/L2300                              | 310700-100-KIT               | 3.25" x 3.625"     | 310701-100-KIT                   | 7" x 2"             |
|                   | L2000-U/L2300-U                          | 310700-101-KIT               | 2.90" x 3.75"      | 310701-101-KIT                   | 7" x 2"             |
|                   | LHM 230                                  | 310700-101-KIT               | 2.90" x 3.75"      | 310701-101-KIT                   | 7" x 2"             |
| Clark             | CGH23/25                                 | 310700-143-KIT*              | 2.75" x 3.75"      | 310701-107-KIT*                  | 7" x 2"             |
|                   | CJ55                                     | 310700-119-KIT*              | 3" x 3.70"         | 310701-121-KIT*                  | 7" x 2"             |
| Dayton            | 2ZE57                                    | 310700-119-KIT*              | 3" x 3.70"         | 310701-121-KIT*                  | 7" x 2"             |
|                   | 2ZE60                                    | 310700-119-KIT*              | 3" x 3.70"         | 310701-121-KIT*                  | 7" x 2"             |
|                   | 3KR84                                    | 310700-122-KIT*              | 3" x 3.75"         |                                  |                     |
|                   | 4YX96                                    | 310700-143-KIT*              | 2.75" x 3.75"      | 310701-107-KIT*                  | 7" x 2"             |
|                   | 4YX97                                    | 310700-119-KIT*              | 3" x 3.70"         | 310701-121-KIT*                  | 7" x 2"             |
|                   | 5LA79                                    | 310700-164-KIT*              | 3" x 3.70"         | 310701-121-KIT*                  | 7" x 2"             |
| Doosan            | AC25                                     | 310700-119-KIT*              | 3" x 3.75"         | 310701-141-KIT*                  | 7" x 2"             |
|                   | HPT28                                    | 310700-119-KIT*              | 3" x 3.75"         | 310701-142-KIT*                  | 7" x 2"             |
| Eagle             | Eagle 55                                 | 310700-164-KIT*              | 3" x 3.70"         | 310701-111-KIT*                  | 7" x 2"             |
| EP                | EP55II                                   | 310700-143-KIT*              | 2.75" x 3.75"      | 310701-107-KIT*                  | 7" x 2"             |
| Global            | 334475                                   | 310700-144-KIT*              | 2.75" x 3.37"      | 310701-144-KIT*                  | 7" x 2"             |
| Harbor Freight    | 39939                                    | 310700-122-KIT*              | 3" x 3.75"         |                                  |                     |
| Hu-lift           | BST                                      | 310700-144-KIT*              | 2.75" x 3.37"      |                                  |                     |
|                   | HP25L                                    | 310700-145-KIT*              | 2.75" x 3.75"      | 310701-145-KIT*                  | 7" x 2"             |
|                   | HSP                                      | 310700-163-KIT*              | 3" x 2"            |                                  |                     |
| Hyster            | HY55                                     | 310700-119-KIT*              | 3" x 3.70"         | 310701-121-KIT*                  | 7" x 2"             |
| JET               | A  | 310700-103-KIT*              | 3" x 2.75"         | 310701-103-KIT*                  | 7" x 2"             |
|                   | J  | 310700-105-KIT*              | 2.75" x 3.75"      | 310701-105-KIT*                  | 7" x 2"             |
|                   | L  | 310700-104-KIT*              | 2.75" x 2.875"     | 310701-104-KIT*                  | 6.5" x 2.75"        |
|                   | PTW                                      | 310700-147-KIT*              | 3" x 3.75"         | 310701-147-KIT*                  | 7" x 2"             |
|                   | PTX                                      | 310700-106-KIT*              | 2.50" x 4"         | 310701-106-KIT*                  | 7" x 2"             |
|                   | W  | 310700-143-KIT*              | 2.75" x 3.75"      | 310701-107-KIT*                  | 7" x 2"             |
| Jungheinrich      | AM2200                                   | 310700-117-KIT*              | 3" x 3.75"         | 310701-117-KIT+*                 | 6.75" x 2"          |
| King              | KJ 2002                                  | 310700-148-KIT*              | 3" x 2.75"         | 310701-148-KIT*                  | 7" x 2"             |
| Lift-Rite/Big Joe | CF & L30                                 | 310700-123-KIT*              | 1.75" x 3" Steel   |                                  |                     |
|                   | L50                                      | 310700-122-KIT*              | 3" x 3.75"         | 310701-108-KIT                   | 8" x 2"             |
|                   | L50 4 Way (CHEP)                         | 310700-127-KIT*              | 1.75" x 3" Steel   |                                  |                     |
|                   | L50 Mini                                 | 310700-126-KIT*              | 2" x 3" Steel      |                                  |                     |
|                   | L55                                      | 310700-109-KIT*              | 3" x 3.75"         | 310701-109-KIT+*                 | 8" x 2"             |
|                   | LCR55 Titan Series                       | 310700-110-KIT               | 3" x 3.75"         | 310701-110-KIT                   | 7" x 2"             |
|                   | LCU & LCU4W                              | 310700-127-KIT*              | 1.75" x 3" Steel   |                                  |                     |
|                   | LR0655                                   | 310700-109-KIT*              | 3" x 3.75"         | 310701-109-KIT+*                 | 8" x 2"             |
|                   | LRP 5000                                 | 310700-101-KIT               | 2.90" x 3.75"      | 310701-101-KIT                   | 7" x 2"             |
|                   | "Titan LCM50, LCU50, LCU4W, LCM4W Frame" | 310700-124-KIT*              | 2" x 3"            |                                  |                     |
| Mighty Lift       | CFA/ ML 55                               | 310700-112-KIT*              | 3" x 3.70"         | 310701-111-KIT*                  | 7" x 2"             |
|                   | ML 55-II & ML55L                         | 310700-112-KIT*              | 3" x 3.70"         | 310701-112-KIT*                  | 7" x 2"             |
| Mobile            | ECO I-55                                 | 310700-115-KIT*              | 3" x 3.50"         | 310701-115-KIT*                  | 7" x 2"             |
|                   | ECO I-55 (2009 & Later)                  | 310700-119-KIT*              | 3" x 3.70"         | 310701-121-KIT*                  | 7" x 2"             |
|                   | ELP55                                    | 310700-164-KIT*              | 3" x 3.70"         | 310701-121-KIT*                  | 7" x 2"             |
|                   | EMSL22                                   | 310700-163-KIT*              | 3" x 2"            |                                  |                     |

Load Wheels are Ultra-Poly 70D  
Steer Wheels are Poly 95A

+Steer wheels are nylon

\*Includes corrosive-resistant surface finish axles and hardware.

\*\*Load Wheel Kits include Load Roller Assemblies w/Bearings, Axles, and Fasteners.

\*\*Complete Wheel Kits include Load Roller Assemblies w/Bearings, Steer Wheel Assemblies w/Bearings, Axles, and Fasteners.

Continued ▶

**Manual Pallet Jack**  
Pre-packaged Wheel Kits (Continued)



| Brand                | Model                           | Load Wheel Kit Part Number** | Load Wheels OD x W | Complete Wheel Kit Part Number** | Steer Wheels OD x W |
|----------------------|---------------------------------|------------------------------|--------------------|----------------------------------|---------------------|
| Mobile               | ML55                            | 310700-114-KIT               | 3" x 3.50"         | 310701-113-KIT                   | 7" x 2"             |
|                      | MLX55                           | 310700-114-KIT               | 3" x 3.50"         | 310701-114-KIT                   | 7" x 2"             |
| Multiton             | J, M, & TM                      | 310700-116-KIT*              | 3" x 3.75"         | 310701-116-KIT*                  | 8" x 2"             |
|                      | T45                             | 310700-103-KIT*              | 3" x 2.75"         | 310701-104-KIT*                  | 6.50" x 2.75"       |
|                      | T50                             | 310700-103-KIT*              | 3" x 2.75"         | 310701-104-KIT*                  | 6.50" x 2.75"       |
|                      | TM55                            | 310700-117-KIT*              | 3" x 3.75"         | 310701-117-KIT+*                 | 6.75" x 2"          |
| Nobile Lift          | AC20 & AC25                     | 310700-119-KIT*              | 3" x 3.70"         | 310701-121-KIT*                  | 7" x 2"             |
|                      | DF                              | 310700-164-KIT*              | 3" x 3.70"         | 310701-121-KIT*                  | 7" x 2"             |
|                      | DF25                            | 310700-164-KIT*              | 3" x 3.70"         | 310701-121-KIT*                  | 7" x 2"             |
| Pallet Mule (Wesley) | AA5000, AA5500                  | 310700-129-KIT*              | 2.90" x 4"         | 310701-129-KIT*                  | 7" x 2"             |
| Pramac               | GS22                            | 310700-162-KIT*              | 3.12" x 3.25"      |                                  |                     |
| Raymond              | RJ50                            | 310700-101-KIT               | 2.90" x 3.75"      | 310701-101-KIT                   | 7" x 2"             |
|                      | RJ50N                           | 310700-101-KIT               | 2.90" x 3.75"      | 310701-101-KIT                   | 7" x 2"             |
| Rol-Lift             | T&E Series 2.9                  | 310700-165-KIT               | 3" x 3.75"         |                                  |                     |
|                      | T&E Series 3.25                 | 310700-166-KIT               | 3.25" x 3.75"      |                                  |                     |
| Total Source         | HJ55                            | 310700-164-KIT*              | 3" x 3.70"         | 310701-121-KIT*                  | 7" x 2"             |
|                      | HJ5500                          | 310700-164-KIT*              | 3" x 3.70"         | 310701-121-KIT*                  | 7" x 2"             |
|                      | TSP5500                         | 310700-164-KIT*              | 3" x 3.70"         | 310701-112-KIT*                  | 7" x 2"             |
| Toyota               | HPT25                           | 310700-101-KIT               | 2.90" x 3.75"      | 310701-101-KIT                   | 7" x 2"             |
|                      | HPT28U                          | 310700-101-KIT               | 2.90" x 3.75"      | 310701-101-KIT                   | 7" x 2"             |
| U-Line               | H-1043, H-1366, H-1193 & H-1484 | 310700-154-KIT*              | 3" x 3.70"         | 310701-121-KIT*                  | 7" x 2"             |
|                      | H-1785                          | 310700-163-KIT*              | 3" x 2"            |                                  |                     |
|                      | H-2186                          | 310700-161-KIT*              | 3" x 3.70"         | 310701-160-KIT+                  | 7" x 2"             |
|                      | H-2507                          | 310700-163-KIT*              | 3" x 2"            |                                  |                     |
|                      | H-2708, H-2900, & H-3045        | 310700-155-KIT*              | 3" x 3.75"         | 310701-155-KIT*                  | 7" x 2"             |
|                      | H-4123                          | 310700-164-KIT*              | 3" x 3.70"         | 310701-111-KIT*                  | 7" x 2"             |
|                      | H-5441                          | 310700-163-KIT*              | 3" x 2"            |                                  |                     |
|                      | H-5442                          | 310700-163-KIT*              | 3" x 2"            |                                  |                     |
|                      | Ultra                           | UL 5500                      | 310700-130-KIT*    | 3" x 3.75"                       | 310701-130-KIT*     |
| Valu-Jack (Relius)   | VJ 5500/6600                    | 310700-119-KIT*              | 3" x 3.70"         | 310701-121-KIT*                  | 7" x 2"             |
| Vestil               | L220DC                          | 310700-163-KIT*              | 3" x 2"            |                                  |                     |
|                      | L270DC                          | 310700-163-KIT*              | 3" x 2"            |                                  |                     |
|                      | PM5                             | 310700-122-KIT*              | 3" x 3.75"         |                                  |                     |
| WanMax               | W55                             | 310700-156-KIT*              | 2.75" x 3.75"      | 310701-156-KIT*                  | 7" x 2"             |
| Wesco                | 272136                          | 310700-157-KIT*              | 3" x 3.37"         |                                  |                     |
|                      | 272746                          | 310700-157-KIT*              | 3" x 3.37"         | 310701-158-KIT*                  | 8" x 2"             |
|                      | 272744                          | 310700-157-KIT*              | 3" x 3.37"         | 310701-158-KIT*                  | 8" x 2"             |
|                      | 272748                          | 310700-157-KIT*              | 3" x 3.37"         | 310701-158-KIT*                  | 8" x 2"             |
|                      | CPI                             | 310700-119-KIT*              | 3" x 3.70"         | 310701-121-KIT*                  | 7" x 2"             |
|                      | CPII                            | 310700-119-KIT*              | 3" x 3.75"         |                                  |                     |
|                      | NTEHL27                         | 310700-163-KIT*              | 3" x 2"            |                                  |                     |
|                      | TEHL21                          | 310700-163-KIT*              | 3" x 2"            |                                  |                     |
|                      | TEHL27                          | 310700-163-KIT*              | 3" x 2"            |                                  |                     |
|                      | TSHL20-33                       | 310700-163-KIT*              | 3" x 2"            |                                  |                     |
| Yale                 | YA55                            | 310700-164-KIT*              | 3" x 3.70"         | 310701-111-KIT*                  | 7" x 2"             |

Load Wheels are Ultra-Poly 70D

Steer Wheels are Poly 95A

+Steer wheels are nylon

\*Includes corrosive-resistant surface finish axles and hardware.

\*\*Load Wheel Kits include Load Roller Assemblies w/Bearings, Axles, and Fasteners.

\*\*Complete Wheel Kits include Load Roller Assemblies w/Bearings, Steer Wheel Assemblies w/Bearings, Axles, and Fasteners.

**Electric Pallet Jack  
Pre-packaged Wheel Kits**



| Brand          | Model   | Load Wheel Kit Part Number** | Load Wheels OD x W |
|----------------|---|------------------------------|--------------------|
| Baker          | EW60  | 310700-241-KIT*              | 3.25" x 6.37"      |
|                | EW80  | 310700-241-KIT*              | 3.25" x 6.37"      |
|                | EWR   | 310700-241-KIT*              | 3.25" x 6.37"      |
|                | EWR60   | 310700-241-KIT*              | 3.25" x 6.37"      |
|                | EWR80   | 310700-241-KIT*              | 3.25" x 6.37"      |
| Barrett        | RPX60B  | 310700-242-KIT*              | 3.25" x 6"         |
|                | RPX80B  | 310700-242-KIT*              | 3.25" x 6"         |
| Big Joe        | E30   | 310700-208-KIT*              | 3" x 3.50"         |
|                | WPT45   | 310700-210-KIT*              | 3.25" x 4.50"      |
| Blue Giant     | EPJ30   | 310700-208-KIT*              | 3" x 3.50"         |
|                | EPJ40   | 310700-208-KIT*              | 3" x 3.50"         |
|                | EPJ45   | 310700-204-KIT*              | 3.25" x 4.50"      |
|                | EPJ60R  | 310700-240-KIT*              | 3.25" x 6.50"      |
| BT Prime Mover | PMX 1 Walkie Pallet Truck   | 310700-209-KIT*              | 3.25" x 5"         |
|                | PMX 45  | 310700-209-KIT*              | 3.25" x 5"         |
|                | PMX Walkie Pallet Truck   | 310700-209-KIT*              | 3.25" x 5"         |
|                | SMX 45 Walkie Pallet Truck  | 310700-204-KIT*              | 3.25" x 4.50"      |
| CAT            | NPP 40  | 310700-209-KIT*              | 3.25" x 5"         |
|                | NPP 60  | 310700-221-KIT*              | 3.25" x 5.93"      |
|                | WR 6000   | 310700-243-KIT*              | 3.25" x 6.50"      |
| Clark          | WPT45   | 310700-210-KIT*              | 3.25" x 4.50"      |
|                | WPX45   | 310700-210-KIT*              | 3.25" x 4.50"      |
| Hyster         | B 60Z   | 310700-215-KIT*              | 3.25" x 6.50"      |
|                | B 80Z   | 310700-215-KIT*              | 3.25" x 6.50"      |
|                | B60ZHD  | 310700-215-KIT*              | 3.25" x 6.50"      |
|                | B80ZHD  | 310700-215-KIT*              | 3.25" x 6.50"      |
|                | W 40 XL/W 40 XT   | 310700-202-KIT*              | 3.25" x 4.50"      |
|                | W 40Z / 45Z (B218)  | 310700-203-KIT*              | 3.25" x 4.50"      |
|                | W 60Z   | 310700-215-KIT*              | 3.25" x 6.50"      |
|                | W 65Z   | 310700-215-KIT*              | 3.25" x 6.50"      |
|                | W 80Z   | 310700-215-KIT*              | 3.25" x 6.50"      |
|                | W45XT   | 310700-216-KIT*              | 3.25" x 4.50"      |
| W45ZHD         | 310700-231-KIT*   | 3.34" x 4.33"                |                    |
| Jungheinrich   | EJE120  | 310700-218-KIT*              | 3.25" x 4.50"      |
| Mitsubishi     | PW23  | 310700-218-KIT*              | 3.25" x 4.50"      |
| Multiton       | ELE 35  | 310700-239-KIT               | 3.25" x 4"         |
|                | ELE 45  | 310700-239-KIT               | 3.25" x 4"         |
| Prime Mover    |  HMX65 | 310700-246-KIT*              | 3.25" x 6"         |
| Nissan         | RPX60N  | 310700-242-KIT*              | 3.25" x 6"         |
|                | RPX80N  | 310700-242-KIT*              | 3.25" x 6"         |
|                | RPXT2   | 310700-242-KIT*              | 3.25" x 6"         |

Load Wheel kits are Durarun Poly 95A

\*Includes corrosive-resistant surface finish axles and hardware.

\*\*LW Kits include Load Wheels w/Bearings, Axles, Lube Fittings, and Screws or Roll Pins.

# Load Wheel Kits and Complete Wheel Kits

## Electric Pallet Jack Pre-packaged Wheel Kits (Continued)



| Brand           | Model                     | Load Wheel Kit<br>Part Number** | Load Wheels<br>OD x W |
|-----------------|---------------------------|---------------------------------|-----------------------|
| Raymond         | 102TF                     | 310700-204-KIT*                 | 3.25" x 4.50"         |
|                 | 102XM Walkie Pallet Truck | 310700-204-KIT*                 | 3.25" x 4.50"         |
|                 | 112                       | 310700-221-KIT*                 | 3.25" x 5.93"         |
|                 | 6210                      | 310700-244-KIT*                 | 4" x 3"               |
|                 | 6210 (Walmart)            | 310700-245-KIT*                 | 4" x 2"               |
|                 | 8210                      | 310700-223-KIT*                 | 3.25" x 4.50"         |
|                 | 8300                      | 310700-221-KIT*                 | 3.25" x 5.93"         |
|                 | 8310                      | 310700-221-KIT*                 | 3.25" x 5.93"         |
|                 | 8400                      | 310700-221-KIT*                 | 3.25" x 5.93"         |
|                 | 8410                      | 310700-221-KIT*                 | 3.25" x 5.93"         |
|                 | 8500                      | 310700-221-KIT*                 | 3.25" x 5.93"         |
|                 | 8510                      | 310700-221-KIT*                 | 3.25" x 5.93"         |
|                 | 8900                      | 310700-221-KIT*                 | 3.25" x 5.93"         |
|                 | Toyota                    | RAS20/25                        | 310700-247-KIT*       |
| 6HBE30          |                           | 310700-221-KIT*                 | 3.25" x 5.93"         |
| 6HBW20          |                           | 310700-224-KIT*                 | 3.25" x 5"            |
| 6HBW23          |                           | 310700-204-KIT*                 | 3.25" x 4.50"         |
| 6HBW30          |                           | 310700-221-KIT*                 | 3.25" x 5.93"         |
| 7HBC30          |                           | 310700-221-KIT*                 | 3.25" x 5.93"         |
| 7HBE30          |                           | 310700-221-KIT*                 | 3.25" x 5.93"         |
| 7HBW23          |                           | 310700-204-KIT*                 | 3.25" x 4.50"         |
| 7HBW30          |                           | 310700-221-KIT*                 | 3.25" x 5.93"         |
| 8HBE30          |                           | 310700-221-KIT*                 | 3.25" x 5.93"         |
| 8HBW23          |                           | 310700-223-KIT*                 | 3.25" x 4.50"         |
| 8HBW30          |                           | 310700-221-KIT*                 | 3.25" x 5.93"         |
| Tora-Max TWB40  |                           | 310700-248-KIT*                 | 3" x 4.50"            |
| Unicarriers     |                           | 2W7                             | 310700-238-KIT*       |
|                 | WLX                       | 310700-238-KIT*                 | 3.25" x 4.50"         |
| Yale            | MP/MPB 040 AC             | 310700-206-KIT*                 | 3.25" x 4.50"         |
|                 | MPB 030 AB                | 310700-206-KIT*                 | 3.25" x 4.50"         |
|                 | MPB 040 AB                | 310700-206-KIT*                 | 3.25" x 4.50"         |
|                 | MPB 040 E (B827)          | 310700-207-KIT*                 | 3.25" x 4.50"         |
|                 | MPB 045 VG                | 310700-231-KIT*                 | 3.34" x 4.33"         |
|                 | MPE 060E (A896 Series)    | 310700-215-KIT*                 | 3.25" x 6.50"         |
|                 | MPE 080E (A890 Series)    | 310700-215-KIT*                 | 3.25" x 6.50"         |
|                 | MPE060VG                  | 310700-215-KIT*                 | 3.25" x 6.50"         |
|                 | MPE080VG                  | 310700-215-KIT*                 | 3.25" x 6.50"         |
|                 | MPW 045 E (B802)          | 310700-207-KIT*                 | 3.25" x 4.50"         |
|                 | MPW 050 E (C802)          | 310700-207-KIT*                 | 3.25" x 4.50"         |
| MPW 060E (A897) | 310700-215-KIT*           | 3.25" x 6.50"                   |                       |
| MPW 065E (A894) | 310700-215-KIT*           | 3.25" x 6.50"                   |                       |

Load Wheel kits are Durarun Poly 95A

\*Includes corrosive-resistant surface finish axles and hardware.

\*\*LW Kits include Load Wheels w/Bearings, Axles, Lube Fittings, and Screws or Roll Pins.

## Ball Bearings

\*Note: ♦ clearance greater than standard,  
▲ shoulder bearing ★ high temp  
● alternative durability ■ lip seals



| O.D.  | I.D.  | Width | Manuf. No. | No Seal/Shield                                      | 1 Seal                               | 2 Seals   | 1 Shield  | 2 Shields                  | 1 Seal, 1 Shield |
|-------|-------|-------|------------|---|--------------------------------------|---|---|----------------------------|------------------|
| 0.500 | 0.250 | 0.219 | FRW188     |   |                                      | 065120-001  |   |                            |                  |
| 0.625 | 0.250 | 0.191 | R4         |   |                                      | 065081-050  |   |                            |                  |
| 0.875 | 0.375 | 0.240 | 400-6      | 065081-040  |                                      |   |   |                            |                  |
| 1.102 | 0.472 | 0.310 | 6001       | 065081-074▲   |                                      |   |   |                            |                  |
| 1.125 | 0.500 | 0.307 | R8         |   |                                      | 065081-001▲   |   |                            |                  |
| 1.181 | 0.393 | 0.349 | 6200       | 065081-012▲<br>065081-075▲                          |                                      | 065081-069▲   |   | 065081-013▲                |                  |
| 1.255 | 0.472 | 0.389 | 6201       |   |                                      | 065081-011■▲<br>065081-015▲                               |   | 065081-014▲                |                  |
| 1.375 | 0.500 | 0.433 | 1621       | 065081-039▲   | 370137♦                              | 065081-037▲   |   |                            |                  |
| 1.375 | 0.625 | 0.339 | R10        |   |                                      | 065081-061▲   |   |                            |                  |
| 1.375 | 0.625 | 0.433 | 99502H     |   |                                      | 065081-038▲   |   |                            |                  |
| 1.378 | 0.590 | 0.428 | 6202       | 065081-060▲<br>065081-073▲                          |                                      | 065081-044▲<br>311000-022                                 |   |                            |                  |
| 1.574 | 0.669 | 0.467 | 6203       | 065081-082  |                                      | 311000-004<br>065081-017★■▲                               |   | 065081-016▲<br>809754      |                  |
| 1.625 | 0.750 | 0.438 | R12        |   |                                      |   |   | 065081-036                 |                  |
| 1.750 | 0.750 | 0.495 | 1635       |   |                                      |   |   |                            |                  |
| 1.844 | 0.750 | 0.562 | ASF-169-3A |   |                                      | 074722  |   |                            |                  |
| 1.850 | 0.669 | 0.546 | 6303       | 065081-072▲   |                                      |   |   | 065081-002▲                |                  |
| 1.850 | 0.787 | 0.546 | 6204       | 065081-080  |                                      | 065081-018▲<br>065081-066<br>311000-005<br>065081-063▲    | 065081-020▲<br>365081-020●                                    | 065081-019▲<br>805494      |                  |
| 1.850 | 0.984 | 0.467 | 6005       |   |                                      |   |   |                            |                  |
| 2.047 | 0.787 | 0.586 | 6304       | 065081-003▲   | 065081-004▲<br>065081-065▲<br>370300 |   |   | 311000-012                 |                  |
| 2.047 | 0.984 | 0.586 | 6205       | 065081-071▲<br>365081-071●<br>065081-083<br>042022▲ |                                      | 065081-051♦▲<br>311000-006<br>065081-023▲                 | 065081-021<br>065081-070▲                                     | 065081-022▲<br>365081-022● |                  |
| 2.047 | 0.984 | 0.625 | 87505      |   |                                      |   |   |                            | 311000-011       |
| 2.047 | 0.984 | 0.709 | 8505       |   |                                      |   |   |                            | 311000-023       |
| 2.047 | 0.984 | 0.813 | 5205       |   |                                      | 370093  | 311000-001  | 311000-016                 |                  |
| 2.165 | 1.181 | 0.507 | 6006       | 065081-032▲   |                                      | 055002-027<br>311000-003<br>065081-031■<br>365081-031●    | 065081-062▲<br>365081-062●                                    |                            |                  |
| 2.165 | 1.181 | 0.901 | 30BG05S5G  | 065089-004  |                                      |   |   |                            |                  |
| 2.440 | 0.984 | 0.669 | 6305       |   | 370185                               | 065081-005▲<br>065081-056♦▲<br>311000-007                 | 065081-057<br>365081-057●<br>365081-057-01▲                   | 311000-013                 |                  |
| 2.440 | 0.984 | 0.995 | 5305       |   |                                      | 065089-003  |   |                            |                  |
| 2.440 | 1.181 | 0.625 | 6206       | 065081-024▲   |                                      | 055002-017<br>065081-010■▲<br>365081-010●<br>065081-054♦▲ | 065081-025▲<br>365081-025●                                    | 065081-041▲<br>370277●     |                  |
| 2.440 | 1.378 | 0.546 | 6007       |   |                                      | 065081-033▲<br>065081-052♦▲<br>055002-014                 |   |                            |                  |
| 2.441 | 0.984 | 0.827 | 8605       |   |                                      |   |   |                            | 370182▲          |
| 2.441 | 1.181 | 0.630 | BL-206     | 042023▲   |                                      |   |   |                            |                  |
| 2.441 | 1.181 | 0.938 | 5206       | 065025-001▲   |                                      | 065025-002▲   |   |                            |                  |
| 2.834 | 1.378 | 0.669 | 6207       |   |                                      | 065081-027▲   | 311000-019  |                            |                  |
| 2.834 | 1.181 | 0.743 | 6306       |   | 055002-018                           | 065081-006▲<br>365081-006♦▲<br>065081-058♦                | 065081-067▲<br>365081-067●                                    | 311000-014                 |                  |
| 2.834 | 1.378 | 1.053 | 5207       |   |                                      | 065089-005  |   |                            |                  |
| 2.952 | 1.771 | 0.625 | 6009       |   |                                      | 065081-079♦   |   |                            |                  |
| 3.149 | 1.378 | 0.822 | 6307       | 065081-081<br>065081-009▲                           |                                      | 065081-085♦▲<br>065081-007                                | 065081-008<br>365081-008●<br>365081-008-01▲<br>365081-008-02▲ | 311000-009                 |                  |
| 3.149 | 1.968 | 0.625 | 6010       | 065081-078  |                                      |   |   |                            |                  |
| 3.149 | 2.165 | 0.506 | 6911       |   |                                      | 065081-076  |   |                            |                  |
| 3.185 | 1.167 | 0.998 | MG206-FFA  |   |                                      | 380103-358  |   |                            |                  |
| 3.224 | 1.375 | 1.219 | MG207-FFWA |   |                                      |   | 380103-426  |                            |                  |
| 3.240 | 1.380 | 1.220 | MG307      |   |                                      | 380050-020  |   |                            |                  |
| 3.250 | 1.246 | 1.222 | MRS-6      |   |                                      |   |   | 380103-484                 |                  |

## Ball Bearings (continued)

| O.D.  | I.D.  | Width | Manuf. No. | No Seal/Shield | 1 Seal | 2 Seals      | 1 Shield                    | 2 Shields  | 1 Seal,<br>1 Shield |
|-------|-------|-------|------------|----------------|--------|--------------|-----------------------------|------------|---------------------|
| 3.346 | 1.771 | 0.743 | 6209       | 065081-029 🚩   |        | 065081-045 🚩 | 065081-028,<br>365081-028 • |            |                     |
| 3.543 | 1.574 | 0.901 | 6308       |                |        | 065081-042 🚩 |                             |            |                     |
| 3.543 | 1.574 | 0.901 | MRC 308    | 065081-048     |        |              |                             |            |                     |
| 3.543 | 1.968 | 0.783 | 6210       |                |        | 065081-059   |                             |            |                     |
| 3.630 | 1.360 | 1.220 | MG207FFUE  |                |        | 380050-067   |                             |            |                     |
| 3.740 | 1.574 | 1.125 | MG208-FFH  |                |        | 380050-063   |                             |            |                     |
| 3.740 | 2.362 | 0.704 | 6012       |                |        | 065081-034 🚩 |                             |            |                     |
| 3.940 | 2.150 | 0.830 | MG207FFU   |                |        | 380050-078   |                             |            |                     |
| 3.940 | 2.560 | 0.430 | 16013      | 807701         |        |              |                             |            |                     |
| 3.940 | 2.560 | 0.710 | 6013       |                |        | 055002-019   |                             |            |                     |
| 3.970 | 1.575 | 1.000 | MG208-FFA  |                |        | 370236       |                             |            |                     |
| 3.975 | 1.772 | 1.125 | MG209      |                |        | 380050-035   |                             |            |                     |
| 3.984 | 1.565 | 1.119 | MG308-FFX  |                |        | 380103-406   |                             |            |                     |
| 3.990 | 1.574 | 1.125 | MG208-FFK  |                |        | 380050-017   |                             |            |                     |
| 4.082 | 1.575 | 1.760 | MG5208     |                |        | 380050-016   |                             |            |                     |
| 4.200 | 1.570 | 1.040 | MG208-FF8  |                |        | 380050-069   |                             |            |                     |
| 4.220 | 1.570 | 1.030 | MG208-FF7  |                |        | 380050-066   |                             |            |                     |
| 4.244 | 1.374 | 0.982 | MG307-FFAB |                |        | 380050-077   |                             |            |                     |
| 4.319 | 1.574 | 1.200 | MG308-FFAC |                |        | 380103-492   |                             |            |                     |
| 4.330 | 2.362 | 0.861 | 6212       | 065081-030     |        | 065081-055 🚩 |                             |            |                     |
| 4.387 | 1.244 | 1.183 | CU2639B    |                |        |              |                             | 380103-428 |                     |
| 4.486 | 1.570 | 1.250 | MG308      |                |        | 380050-019   |                             |            |                     |
| 4.702 | 1.571 | 1.100 | MG308-FFW  |                |        | 380103-451   |                             |            |                     |
| 4.990 | 2.360 | 1.220 | 1276       |                |        | 380050-034   |                             |            |                     |
| 5.905 | 3.936 | 0.937 | 6020       |                |        | 065081-043 🚩 |                             |            |                     |
| 6.500 | 5.000 | 0.750 | FPXF500    | 042021         |        |              |                             |            |                     |

🚩 WARNING: Cancer and reproductive harm - [www.P65Warnings.ca.gov](http://www.P65Warnings.ca.gov)

### Ball Bearings with Snap Ring



| O.D.  | I.D.  | Width | Manuf. No. | No Seal/<br>Shield | 2 Rubber<br>Seals |
|-------|-------|-------|------------|--------------------|-------------------|
| 1.850 | 0.787 | 0.546 | 6204       |                    | 065010-001 🚩      |
| 2.047 | 0.787 | 0.585 | 6304       |                    | 065010-006 🚩      |
| 2.047 | 0.984 | 0.585 | 6205       |                    | 065010-005 🚩      |
| 2.165 | 1.181 | 0.507 | 6006       |                    | 065010-007 🚩      |
| 2.440 | 1.378 | 0.546 | 6007       |                    | 065010-004 🚩      |
| 2.834 | 1.378 | 1.053 | 5207       | 065010-008         |                   |

🚩 WARNING: Cancer - [www.P65Warnings.ca.gov](http://www.P65Warnings.ca.gov)

### Thrust Bearings



| O.D.  | I.D.  | Width | Manuf. No. | Crown Part No. |
|-------|-------|-------|------------|----------------|
| 1.516 | 0.865 | 0.451 | 22TAG12    | 380030-048     |
| 2.000 | 1.110 | 0.630 | 28TAG12    | 380050-059     |
| 2.211 | 1.124 | 0.628 | 28TAG16H   | 380105-692     |
| 2.760 | 1.760 | 0.550 | 51110      | 055018-001     |
| 2.938 | 2.010 | 0.625 | T199       | 065043         |
| 5.000 | 3.875 | 0.688 | T387       | 065066         |
| 7.000 | 5.813 | 0.688 | T581       | 065086         |

### Needle Bearings



| O.D.  | I.D.  | Width | Manuf. No. | Crown Part No. |
|-------|-------|-------|------------|----------------|
| 1.000 | 0.750 | 0.875 | BA121614   | 065082         |
| 1.140 | 1.180 | 0.870 | HMK2230    | 380050-068     |
| 1.380 | 1.100 | 0.980 | HK283525   | 380050-064     |
| 1.500 | 1.187 | 0.625 | YB-1910    | 072092         |
| 1.540 | 1.100 | 1.180 |            | 380050-060     |
| 2.500 | 2.120 | 1.000 | BA3416Z-OH | 065013-004     |

### Thrust Roller Bearing



| O.D.  | I.D.  | Width | Manuf. No. | Crown Part No. |
|-------|-------|-------|------------|----------------|
| 2.240 | 0.500 | 1.060 | MG205      | 380050-018     |

### Roller Bearings



| O.D.  | I.D.  | Width | Manuf. No. | Crown Part No. |
|-------|-------|-------|------------|----------------|
| 2.063 | 1.500 | 1.250 | BR-243320  | 073449         |
| 2.250 | 1.688 | 1.000 | BR273616   | 073442         |
| 2.830 | 1.730 | 0.120 | NU207E     | 065193         |

### Spherical Bearings



| O.D.  | I.D.  | Width | Manuf. No.  | Crown Part No. |
|-------|-------|-------|-------------|----------------|
| 1.180 | 0.670 | 0.550 | GE17ES-2RS  | 380050-062     |
| 1.380 | 0.790 | 0.630 | GE20ES-2RS  | 380050-025     |
| 1.438 | 0.875 | 0.765 | GEZ22ES-2RS | 380050-058     |
| 2.438 | 1.500 | 1.125 | GEZ108ES    | 370297         |
| 4.726 | 2.555 | 1.220 |             | 380100-515     |

# Bearings

## Cone Bearings



| O.D.  | I.D.  | Width | Manuf. No.      | Crown Part No.       | Use With Cup |
|-------|-------|-------|-----------------|----------------------|--------------|
| N/A   | 0.580 | 1.250 | L44600LB        | 312000-007           |              |
| N/A   | 0.747 | 0.727 | LM11900LA       | 312000-005           |              |
| N/A   | 0.750 | 0.439 | A6075           | 065045▲              | 065044▲      |
| N/A   | 0.750 | 0.655 | LM11949         | 065137               | 065136       |
| N/A   | 0.750 | 0.755 | 09067 20024     | 312000-006           |              |
| N/A   | 0.780 | 1.630 | LM501349        | 065148               | 065147       |
| N/A   | 0.875 | 0.561 | 07087           | 071544               | 071545       |
| N/A   | 0.980 | 0.870 | X33205          | 134610               | 134609       |
| N/A   | 1.000 | 0.561 | 7100            | 071543               | 071545       |
| N/A   | 1.000 | 0.622 | 07000LA         | 312000-010           | 071545       |
| N/A   | 1.000 | 0.813 | 15100           | 312000-011           | 312000-003   |
| N/A   | 1.000 | 1.000 | L44643          | 312000-008           | 065134       |
| N/A   | 1.063 | 0.580 | L44649          | 065135 or 380050-075 | 065134       |
| N/A   | 1.188 | 0.847 | M86610          | 065110               | 065109       |
| N/A   | 1.250 | 0.655 | LM67048         | 065106               | 065105       |
| N/A   | 1.250 | 0.715 | 15123           | 312000-015           | 312000-003   |
| N/A   | 1.250 | 1.000 | 2580            | 135282               | 135281       |
| N/A   | 1.375 | 0.720 | LM48548         | 065131               | 065118       |
| N/A   | 1.375 | 1.052 | 14136A          | 312000-013           | 312000-014   |
| N/A   | 1.380 | 0.988 | 25877           | 312000-012           | 312000-004   |
| N/A   | 1.406 | 1.003 | HM88648         | 065052               | 065051       |
| N/A   | 1.438 | 1.138 | HM89249         | 065097               | 065096       |
| N/A   | 1.625 | 1.003 | 26882           | 065099               | 065098       |
| N/A   | 1.781 | 0.781 | LM603049        | 065133               | 065132       |
| N/A   | 1.797 | 1.003 | 25590           | 042020               | 042019       |
| N/A   | 1.969 | 0.847 | JLM104948       | 380050-006           |              |
| N/A   | 2.000 | 0.880 | LM104949        | 065108               | 065107       |
| N/A   | 2.125 | 1.455 | 539             | 065128               | 065127       |
| N/A   | 2.165 | 0.906 | JLM506849       | 065019               | 065018       |
| N/A   | 2.165 | 1.142 | JM207049        | 065024               | 065023       |
| N/A   | 2.625 | 1.196 | 39590           | 065101               | 065100       |
| 4.302 | 2.678 | 1.030 | 395LA           | 380101-226           |              |
| N/A   | 2.688 | 0.875 | 399A            | 380050-072           |              |
| N/A   | 2.880 | 1.190 | 33287           | 065146               | 065145       |
| N/A   | 2.950 | 0.980 | JLM714149 N-000 | 045319*▲             | 045318▲      |
| N/A   | 2.952 | 0.984 | JLM714149       | 077015               | 077014       |
| N/A   | 3.150 | 1.140 | X32016X         | 135495               | 135500       |
| N/A   | 3.250 | 1.313 | 47686           | 065161               | 065162       |
| N/A   | 3.346 | 1.142 | JM716648        | 065157               | 065158       |
| N/A   | 3.750 | 1.141 | 42375           | 065126               | 065125       |

▲WARNING: Cancer and reproductive harm - www.P65Warnings.ca.gov

## Cup Bearings



| O.D.  | I.D. | Width | Manuf. No.      | Crown Part No. | Use With Cone    |
|-------|------|-------|-----------------|----------------|------------------|
| 1.576 | N/A  | 0.375 | A6157           | 065044▲        | 065045▲          |
| 1.781 | N/A  | 0.610 | LM11910         | 065136         | 065137           |
| 1.938 | N/A  | 0.562 | 09195           | 312000-001     |                  |
| 1.969 | N/A  | 0.531 | 07196           | 071545         | 071544 or 071543 |
| 1.979 | N/A  | 0.560 | L44610          | 065134         | 065135           |
| 2.050 | N/A  | 0.710 | Y33205          | 134609         | 134610           |
| 2.328 | N/A  | 0.625 | LM67010         | 065105         | 065106           |
| 2.441 | N/A  | 0.715 | 15245           | 312000-003     | 312000-015       |
| 2.532 | N/A  | 0.658 | M86649          | 065109         | 065110           |
| 2.563 | N/A  | 0.550 | LM48510         | 065118         | 065131           |
| 2.717 | N/A  | 0.625 | 14274           | 312000-014     | 312000-013       |
| 2.750 | N/A  | 0.750 | 2523            | 135281         | 135282           |
| 2.844 | N/A  | 0.771 | HM88610         | 065051         | 065052           |
| 2.875 | N/A  | 0.748 | 25821           | 312000-004     | 312000-012       |
| 2.890 | N/A  | 0.580 | LM501310        | 065147         | 065148           |
| 3.063 | N/A  | 0.594 | LM603011        | 065132         | 065133           |
| 3.126 | N/A  | 0.752 | 26822           | 065098         | 065099           |
| 3.126 | N/A  | 1.160 | HM89210         | 065096         | 065097           |
| 3.228 | N/A  | 0.847 | JLM104910       | 380050-005     |                  |
| 3.250 | N/A  | 0.650 | LM104911        | 065107         | 065108           |
| 3.266 | N/A  | 0.752 | 25520           | 042019         | 042020           |
| 3.543 | N/A  | 0.728 | JLM506810       | 065018         | 065019           |
| 3.740 | N/A  | 0.925 | JM207010        | 065023         | 065024           |
| 4.250 | N/A  | 1.125 | 532X            | 065127         | 065128           |
| 4.331 | N/A  | 0.074 | 394A            | 380050-076     |                  |
| 4.439 | N/A  | 0.940 | 39520           | 065100         | 065101           |
| 4.528 | N/A  | 0.748 | JLM714110       | 077014         | 077015           |
| 4.530 | N/A  | 0.750 | JLM714110 N-000 | 045318*▲       | 045319▲          |
| 4.630 | N/A  | 0.150 | 33462           | 065145         | 065146           |
| 4.920 | N/A  | 0.870 | Y32016X         | 135500         | 135495           |
| 5.110 | N/A  | 0.945 | JH716610        | 065158         | 065157           |
| 5.250 | N/A  | 1.031 | 47620           | 065162         | 065161           |
| 5.844 | N/A  | 0.844 | 42584           | 065125         | 065126           |

▲WARNING: Cancer and reproductive harm - www.P65Warnings.ca.gov

## Cup & Cone Bearings



| O.D.  | I.D.  | Width | Manuf. No.          | Crown Part No. |
|-------|-------|-------|---------------------|----------------|
| 1.625 | 0.563 |       | 30302               | 794109-002     |
| 1.938 | 1.063 |       | L446410             | 794109-001     |
| 2.438 | 1.188 | 0.688 | 30206               | 380050-070     |
| 2.438 | 1.375 | 0.750 | 32007X              | 380050-073     |
| 2.440 | 1.171 | 0.846 | 32206               | 380050-061     |
| 2.559 | 1.181 |       | 30206JR             | 794109-007     |
| 2.656 | 1.500 | 1.578 | LM29748             | 075717         |
| 2.680 | 1.570 | 0.750 | 32008X              | 311000-024     |
| 2.718 | 1.250 | 0.781 | 14124               | 065069         |
| 2.813 | 1.375 | 0.938 | 32207               | 380100-564     |
| 2.835 | 1.181 | 0.817 | 30306               | 380030-127     |
| 2.835 | 1.375 | 0.740 | 30207               | 380050-056     |
| 2.835 | 1.378 | 0.709 | X30207M             | 794109-006     |
| 2.953 | 1.772 | 0.808 | 32009               | 380100-530     |
| 3.000 | 1.980 | 0.969 | L44610/L44649       | 370181         |
| 3.125 | 1.563 | 0.813 | 30208               | 380050-071     |
| 3.125 | 1.938 | 0.813 | 32010X              | 380050-074     |
| 3.228 | 1.969 | 0.847 | JLM104910/JLM104948 | 380030-244     |
| 3.347 | 0.748 | 0.974 | 32209               | 380050-055     |
| 3.350 | 1.770 | 0.820 | 30209               | 380050-065     |
| 3.540 | 2.170 | 0.910 | 32011XJ             | 794109-004     |
| 3.540 | 2.170 | 0.910 | 32011               | 380050-036     |
| 3.543 | 0.748 | 0.974 | 32210               | 380050-057     |
| 3.740 | 2.360 | 1.220 |                     | 380050-054     |
| 3.740 | 2.362 | 0.906 |                     | 380030-126     |
| 3.938 | 2.188 | 1.063 | 32211               | 380100-565     |
| 3.940 | 2.560 | 0.910 | 32013XU             | 794109-003     |
| 4.331 | 0.945 | 0.906 | 32212               | 380050-003     |
| 4.921 | 0.827 | 1.034 | 30214               | 380050-004     |



# Tire Application Guide

## Tires

| Wheel Series                          | Compound Number<br>††  | Non-Marking Compound* | Shore A Hardness | Application Types         |   |   |                   |         |
|---------------------------------------|--|-----------------------|------------------|---------------------------|---|---|-------------------|---------|
|                                       |  |                       |                  | Long Runs/<br>Heavy Loads | Dock Boards/<br>Expansion<br>Joints<br>(Chunking) | Metal Chips/<br>Floor Debris<br>(Flat Spotting) | Wet<br>Conditions | Freezer |
| <b>100</b><br>SERIES<br>Light Duty    | These economical 100 Series Light Duty wheel compounds are best suited for light loads and intermittent use.                     |                       |                  |                           |   |   |                   |         |
|                                       | 141  | 151                   | 91A              |                           | ○   | ○   | ○                 | ○       |
|                                       | 142  | 152                   | 93A              |                           | ○   | ○   | ○                 | ○       |
| <b>200</b><br>SERIES<br>Mid-Range     | The Mid-Range wheels are designed for light to medium loads and short to medium runs.  |                       |                  |                           |   |   |                   |         |
|                                       | 241  | 251                   | 87A              |                           | ●   | ●   | ●                 | ●       |
|                                       | 242  | 252                   | 85A              |                           | ●   | ●   | ●                 | ●       |
| <b>300</b><br>SERIES<br>High Capacity | For the typical demands of most applications, High Capacity wheels feature compounds designed for high capacities and long runs. |                       |                  |                           |   |   |                   |         |
|                                       | 341  | 351                   | 93A              | ●                         | ●   | ●   | ●                 | ●       |
|                                       | 342  | 352                   | 90A              | ●                         | ●   | ●   | ●                 | ●       |
|                                       | 343  | 353                   | 85A              | ●                         | ●   | ●   | ●                 | ●       |
|                                       | 348  | 358                   | 95A              | ●                         | ●   | ●   | ●                 | ●       |
| <b>400</b><br>SERIES<br>Heavy Duty    | Heavy Duty wheels are designed for maximum capacities and extreme runs.  |                       |                  |                           |   |   |                   |         |
|                                       | 441  | 451                   | 99A              | ●                         |   |   |                   |         |
|                                       | 442  |                       | 93A              | ●                         | ●   | ●   |                   |         |
| <b>Center Groove</b>                  |  |                       |                  | ●                         |   |   |                   |         |
| <b>Thick Sipe</b>                     |  |                       |                  |                           |   |   | ●                 | ●       |
| <b>Thin Sipe</b>                      |  |                       |                  |                           |   |   | ●                 | ●       |
| <b>Diamond Groove</b>                 |  |                       |                  |                           |   |   | ●                 | ○       |
| <b>Hole Pattern</b>                   |  |                       |                  |                           |   |   | ●                 | ●       |

\* - All Polyurethane tires are non-marking

†† - Not all compounds are available

○ = Good

● = Better

● = Best

WHEELS AND TIRES

## Treads



**Contour/Smooth -01**  
All purpose.



**Center Groove -02**  
Dissipates heat and provides better traction. Heavy loads, long runs, extreme heat.

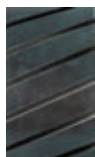

**22° Thick Sipe -03**  
Increase traction. Good for wet/freezer application, standing water.

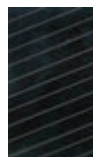

**22° Thin Sipe -04**  
Increase traction. Great for wet/freezer application.



**Diamond Groove -05**  
Increase traction. Good for wet/freezer application, standing water.

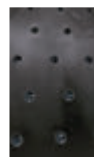

**Hole Pattern -06**  
Great on damp floors, produce areas, and cold storage facilities. Resistant to chunking and tearing.

NOTE: Treads not available in all sizes.



Call your local Crown dealer to help you determine the right load wheels or tires for your application and start minimizing costs and maximizing productivity today.

## Polyurethane Tires by Size

| O.D.              | Width | I.D.   | Crown Part Number | Notes                    |
|-------------------|-------|--------|-------------------|--------------------------|
| <b>6.00 O.D.</b>  |       |        |                   |                          |
| 6.00              | 3.00  | 4.000  | 310198            |                          |
| <b>8.00 O.D.</b>  |       |        |                   |                          |
| 8.00              | 4.00  | 6.250  | 310002            |                          |
| 8.00              | 4.00  | 6.500  | 310199            |                          |
| 8.00              | 4.50  | 6.500  | 310246            | 1" Insert for Brake      |
| 8.00              | 4.50  | 4.500  | 310003            |                          |
| <b>8.50 O.D.</b>  |       |        |                   |                          |
| 8.50              | 4.00  | 4.000  | 077984            |                          |
| <b>9.00 O.D.</b>  |       |        |                   |                          |
| 9.00              | 2.875 | 6.63   | 310296            |                          |
| 9.00              | 3.50  | 6.500  | 310005            |                          |
| 9.00              | 5.00  | 5.000  | 077848            |                          |
| 9.00              | 5.00  | 5.000  | 317848            |                          |
| 9.00              | 5.00  | 5.750  | 126266            |                          |
| 9.00              | 7.00  | 6.250  | 310293            |                          |
| <b>10.00 O.D.</b> |       |        |                   |                          |
| 10.00             | 3.00  | 7.500  | 310007            |                          |
| 10.00             | 3.50  | 8.000  | 310008            |                          |
| 10.00             | 4.00  | 6.500  | 075715            |                          |
| 10.00             | 4.00  | 6.500  | 310049            |                          |
| 10.00             | 4.50  | 7.000  | 310237            |                          |
| 10.00             | 4.50  | 8.000  | 310009            |                          |
| 10.00             | 4.75  | 6.500  | 310011            | Contour Profile          |
| 10.00             | 4.75  | 6.500  | 310200            | 10° Angle                |
| 10.00             | 5.00  | 6.500  | 107933            | Contour - 18° Angle      |
| 10.00             | 5.00  | 6.500  | 310294            | Contour - 18° Angle      |
| 10.00             | 5.00  | 6.500  | 310012            | Smooth 15° Angle         |
| 10.00             | 5.00  | 6.500  | 310202            | Beveled Edge             |
| 10.00             | 6.00  | 6.250  | 310013            |                          |
| 10.00             | 6.00  | 6.500  | 310014            |                          |
| 10.00             | 7.00  | 6.250  | 310015            |                          |
| 10.00             | 7.00  | 8.000  | 310016            |                          |
| <b>10.50 O.D.</b> |       |        |                   |                          |
| 10.50             | 3.50  | 8.000  | 310017            |                          |
| 10.50             | 4.00  | 8.000  | 105088            |                          |
| 10.50             | 4.50  | 8.000  | 105089            |                          |
| 10.50             | 5.00  | 5.000  | 310019            |                          |
| 10.50             | 5.00  | 6.500  | 310020            |                          |
| 10.50             | 6.00  | 5.000  | 310021            |                          |
| 10.50             | 6.00  | 6.500  | 310022            |                          |
| 10.50             | 6.50  | 8.000  | 310023            |                          |
| 10.50             | 7.00  | 6.500  | 310024            |                          |
| 10.50             | 8.00  | 6.500  | 310311            |                          |
| <b>12.00 O.D.</b> |       |        |                   |                          |
| 12.00             | 4.00  | 8.000  | 310030            |                          |
| 12.00             | 4.50  | 8.000  | 310025            |                          |
| 12.00             | 5.00  | 8.000  | 310027            |                          |
| 12.00             | 5.00  | 9.000  | 310026            | Contour Profile          |
| 12.00             | 5.00  | 9.000  | 310029            | Smooth                   |
| 12.00             | 5.50  | 8.000  | 310028            |                          |
| <b>12.75 O.D.</b> |       |        |                   |                          |
| 12.75             | 5.50  | 8.000  | 310285            |                          |
| <b>13.00 O.D.</b> |       |        |                   |                          |
| 13.00             | 4.50  | 8.000  | 079494            |                          |
| 13.00             | 4.50  | 8.000  | 310031            | Angled to a 2" footprint |
| 13.00             | 4.50  | 8.000  | 310204            |                          |
| 13.00             | 4.50  | 10.000 | 310032            |                          |
| 13.00             | 5.50  | 8.000  | 079266            |                          |
| 13.00             | 5.50  | 8.000  | 319266            |                          |
| 13.00             | 5.50  | 9.500  | 121501            |                          |
| 13.00             | 6.00  | 10.500 | 310034            |                          |

**Note:** You need to add the compound and tread part number to the base number listed above. See compounds and treads listed on page 11.19 for the dash number. Complete part number format is XXXXXX-XXX-XX. Contact your local Crown dealer for pricing and availability of each compound and tread.

| O.D.              | Width | I.D.   | Crown Part Number | Notes           |
|-------------------|-------|--------|-------------------|-----------------|
| <b>13.50 O.D.</b> |       |        |                   |                 |
| 13.50             | 4.50  | 8.000  | 310035            |                 |
| 13.50             | 4.50  | 10.25  | 310310            |                 |
| 13.50             | 5.00  | 8.000  | 310038            |                 |
| 13.50             | 5.50  | 8.000  | 077050            | Contour Profile |
| 13.50             | 5.50  | 8.000  | 310039            | Smooth          |
| 13.50             | 5.50  | 10.000 | 310053            |                 |
| 13.50             | 5.50  | 10.500 | 310284            |                 |
| 13.50             | 6.00  | 8.000  | 100368            |                 |
| 13.50             | 6.00  | 10.000 | 114493            |                 |
| 13.50             | 6.00  | 10.000 | 314493            |                 |
| 13.50             | 6.00  | 10.500 | 310037            |                 |
| 13.50             | 6.50  | 8.000  | 310040            |                 |
| 13.50             | 7.00  | 8.000  | 100700            |                 |
| 13.50             | 7.00  | 10.000 | 114494            |                 |
| 13.50             | 7.00  | 10.000 | 314494            |                 |
| <b>13.75 O.D.</b> |       |        |                   |                 |
| 13.75             | 5.50  | 10.50  | 310286            |                 |
| <b>14.00 O.D.</b> |       |        |                   |                 |
| 14.00             | 4.50  | 8.000  | 310042            |                 |
| 14.00             | 5.00  | 10.000 | 310045            |                 |
| 14.00             | 5.00  | 11.250 | 310044            |                 |
| 14.00             | 6.00  | 11.250 | 310046            |                 |
| 14.00             | 8.00  | 10.250 | 310271            |                 |
| 14.00             | 8.00  | 11.250 | 310047            |                 |
| <b>14.75 O.D.</b> |       |        |                   |                 |
| 14.75             | 6.50  | 10.750 | 310272            |                 |
| <b>15.00 O.D.</b> |       |        |                   |                 |
| 15.00             | 5.00  | 11.250 | 310048            |                 |
| 15.00             | 6.00  | 11.250 | 310052            |                 |
| 15.00             | 6.00  | 11.750 | 310054            |                 |
| 15.00             | 6.50  | 10.750 | 310463            |                 |
| 15.00             | 7.00  | 11.250 | 310055            |                 |
| 15.00             | 8.00  | 11.200 | 090270            |                 |
| 15.00             | 8.00  | 11.250 | 310056            |                 |
| <b>15.25 O.D.</b> |       |        |                   |                 |
| 15.25             | 7.00  | 11.250 | 133904            |                 |
| <b>15.50 O.D.</b> |       |        |                   |                 |
| 15.50             | 5.00  | 10.000 | 310057            |                 |
| 15.50             | 6.00  | 10.000 | 310058            |                 |
| <b>15.98 O.D.</b> |       |        |                   |                 |
| 15.98             | 6.69  | 13.19  | 149214            |                 |
| <b>16.00 O.D.</b> |       |        |                   |                 |
| 16.00             | 4.00  | 12.125 | 310059            |                 |
| 16.00             | 5.00  | 10.500 | 310060            |                 |
| 16.00             | 6.00  | 10.500 | 310061            |                 |
| 16.00             | 7.00  | 10.500 | 139567            |                 |
| 16.00             | 7.00  | 10.500 | 310567            |                 |
| 16.00             | 7.00  | 12.000 | 310063            |                 |
| <b>16.25 O.D.</b> |       |        |                   |                 |
| 16.25             | 5.00  | 11.250 | 310064            |                 |
| 16.25             | 6.00  | 11.250 | 310065            |                 |
| 16.25             | 7.00  | 11.250 | 310066            |                 |
| 16.25             | 10.00 | 11.250 | 310228            |                 |
| <b>18.00 O.D.</b> |       |        |                   |                 |
| 18.00             | 5.00  | 12.125 | 310067            |                 |
| 18.00             | 6.00  | 12.125 | 310068            |                 |
| 18.00             | 7.00  | 12.125 | 310069            |                 |
| 18.00             | 7.00  | 15.000 | 310070            |                 |
| 18.00             | 8.00  | 12.125 | 310071            |                 |
| 18.00             | 9.00  | 12.125 | 310072            |                 |
| <b>20.00 O.D.</b> |       |        |                   |                 |
| 20.00             | 9.00  | 16.000 | 310503            |                 |
| <b>21.00 O.D.</b> |       |        |                   |                 |
| 21.00             | 7.00  | 15.000 | 310073            |                 |
| 21.00             | 8.00  | 15.000 | 310121            |                 |
| <b>22.00 O.D.</b> |       |        |                   |                 |
| 22.00             | 5.00  | 16.000 | 310074            |                 |
| 22.00             | 8.00  | 16.000 | 310075            |                 |
| 22.00             | 9.00  | 16.000 | 310207            |                 |
| 22.00             | 10.00 | 16.000 | 310076            |                 |



## Hole Tires

### Polyurethane Hole Pattern Tires

- Great on damp floors
- Resistance to chunking and tearing
- Cold storage applications
- Produce areas

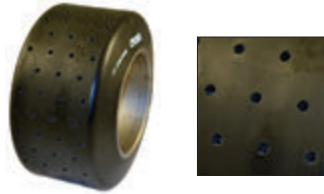

| O.D.  | Width | I.D. | Crown Part Number |
|-------|-------|------|-------------------|
| 9.00  | 5.00  | 5.00 | 317848-341-06     |
| 9.00  | 5.00  | 5.75 | 316266-341-06     |
| 10.00 | 4.00  | 6.50 | 310049-243-06     |
| 10.00 | 4.75  | 6.50 | 310011-341-06     |
| 10.00 | 5.00  | 6.50 | 310294-341-06     |
| 10.00 | 7.00  | 6.25 | 310015-341-06     |
| 12.00 | 4.50  | 8.00 | 310025-341-06     |
| 12.00 | 5.50  | 8.00 | 310028-341-06     |
| 12.00 | 5.50  | 8.00 | 310028-351-06     |
| 13.00 | 4.50  | 8.00 | 310204-243-06     |
| 13.00 | 4.50  | 8.00 | 310204-341-06     |
| 13.00 | 4.50  | 8.00 | 310204-352-06     |
| 13.00 | 5.50  | 8.00 | 319266-243-06     |
| 13.00 | 5.50  | 8.00 | 319266-253-06     |
| 13.00 | 5.50  | 8.00 | 319266-341-06     |
| 13.00 | 5.50  | 9.50 | 121501-243-06     |
| 13.00 | 5.50  | 9.50 | 121501-341-06     |
| 13.00 | 5.50  | 9.50 | 121501-342-06     |

| O.D.  | Width | I.D.  | Crown Part Number |
|-------|-------|-------|-------------------|
| 13.00 | 5.50  | 9.50  | 121501-351-06     |
| 13.00 | 5.50  | 9.50  | 121501-352-06     |
| 13.50 | 4.50  | 8.00  | 310035-243-06     |
| 13.50 | 4.50  | 8.00  | 310035-341-06     |
| 13.50 | 5.50  | 8.00  | 310039-243-06     |
| 13.50 | 5.50  | 8.00  | 310039-341-06     |
| 13.50 | 5.50  | 8.00  | 310039-342-06     |
| 13.50 | 6.00  | 8.00  | 310368-341-06     |
| 13.50 | 6.00  | 10.00 | 314493-341-06     |
| 13.50 | 6.00  | 10.50 | 310037-243-06     |
| 13.50 | 6.00  | 10.50 | 310037-341-06     |
| 13.50 | 6.00  | 10.50 | 310037-342-06     |
| 13.50 | 7.00  | 10.00 | 314494-341-06     |
| 15.00 | 5.00  | 11.25 | 310048-243-06     |
| 15.00 | 5.00  | 11.25 | 310048-341-06     |
| 16.00 | 6.00  | 10.50 | 310061-243-06     |
| 16.00 | 7.00  | 10.50 | 310567-341-06     |
| 16.25 | 6.00  | 11.25 | 310065-341-06     |
| 16.25 | 7.00  | 11.25 | 310066-341-06     |
| 18.00 | 7.00  | 12.13 | 310069-243-06     |
| 18.00 | 7.00  | 12.13 | 310069-341-06     |

## Sweeper Scrubber Rubber Tires

405



406



| O.D.  | Width | I.D.   | Profile      | Manufacturer | Compound | Crown Part Number |
|-------|-------|--------|--------------|--------------|----------|-------------------|
| 10.00 | 5.00  | 6.50   | Diamond Sipe | Superior     | P7       | 350007-406-05     |
| 10.00 | 5.00  | 6.50   | Smooth       | Superior     | P7       | 350007-406-41     |
| 12.00 | 4.50  | 8.00   | Diamond Sipe | Superior     | P7       | 350032-406-05     |
| 12.00 | 4.50  | 8.00   | Smooth       | Superior     | P7       | 350032-406-41     |
| 13.50 | 5.50  | 8.00   | Diamond Sipe | Superior     | P7       | 350055-406-05     |
| 13.50 | 5.50  | 8.00   | Smooth       | Superior     | P7       | 350055-406-41     |
| 16.00 | 3.50  | 12.125 | Diamond Sipe | Superior     | P7       | 350066-406-05     |
| 16.00 | 5.00  | 12.125 | Diamond Sipe | Superior     | P7       | 350056-406-05     |
| 16.00 | 5.00  | 12.125 | Smooth       | Superior     | P7       | 350056-406-41     |
| 16.00 | 6.00  | 10.50  | Lugged       | Monarch      | Monogrip | 350054-405-42     |
| 16.00 | 6.00  | 10.50  | Diamond Sipe | Superior     | P7       | 350054-406-05     |
| 16.00 | 6.00  | 10.50  | Smooth       | Superior     | P7       | 350054-406-41     |
| 16.25 | 4.00  | 11.25  | Lugged       | Monarch      | Monogrip | 350003-405-42     |
| 16.25 | 5.00  | 11.25  | Lugged       | Monarch      | Monogrip | 350017-405-42     |
| 16.25 | 6.00  | 11.25  | Lugged       | Monarch      | Monogrip | 350018-405-42     |
| 16.25 | 6.00  | 11.25  | Diamond Sipe | Superior     | P7       | 350018-406-05     |
| 16.25 | 6.00  | 11.25  | Smooth       | Superior     | P7       | 350018-406-41     |
| 18.00 | 6.00  | 12.125 | Lugged       | Monarch      | Rubber   | 350022-405-42     |
| 18.00 | 6.00  | 12.125 | Diamond Sipe | Superior     | P7       | 350022-406-05     |
| 18.00 | 6.00  | 12.125 | Smooth       | Superior     | P7       | 350022-406-41     |

**WARNING: Sweeper scrubber tires are only to be used on scrubber trucks as misapplication on a lift truck will affect stability and reduce the load capacity of forklift trucks by 30% or more.**

## Tire Racks

### Tire Racks

| Part Number | Description | Outside Dimensions          |
|-------------|-------------|-----------------------------|
| 300134      | 3 shelves   | 3'10" W x 3'7" D x 6' H     |
| 300134-001  | 4 shelves   | 3'4" W x 2'6" D x 5'6.25" H |

**WARNING:** Cancer and reproductive harm - [www.P65Warnings.ca.gov](http://www.P65Warnings.ca.gov)



300134



300134-001

One Source Hubs



| Part No.   | Dimensions  | OE                         | Truck Model  | Cross References      | Bolts  |
|------------|-------------|----------------------------|--|-----------------------|--|
| 370061     | 5 x 2.5     | Yale<br>Hyster             | MPB040<br>B60Z   | 501087300<br>2308186  |  |
| 358002     | 6.5 x 3.317 | Raymond                    | Gofer, 109 Walkies, NPV 60   | 850-135-500           | 6 Bolt Hub   |
| 358003     | 6.5 x 3.3   | Raymond                    | 109, 111, 112, 113, 114 Pallet Jacks, 111, 112, 113, 114 Walkies   | 850-138-111           | 5 Bolt Hub   |
| 358004     | 6.25 x 7    | Raymond                    | 630, 640, 650 Counterbalance Trucks  | 123-000-586           | Steer Hub  |
| 358005     | 10.5 x 4.44 | Raymond                    | Easi Reach, Easi Order Picker  | 828-003-073           | 7 Bolt Concave Hub;<br>lug bolt EZ Reach<br>370547 |
| 358006     | 8.99 x 4.98 | Raymond                    | Easi Order Picker  | 114-008-501           | 5 Bolt Raised Lip Dr. Hub                          |
| 358007     |             | Komatsu                    | FD20,23,25,28,30-12, FG20/C/H/HT/T, 23/T, 25/C/H/HT/T, 28/T, 30/C/H/HT/T - 12,14   | 3EB-21-32171          |  |
| 358008     |             | Caterpillar/<br>Mitsubishi | FD20/25/28/30/33/35, FG20/25/28/30/33/35, P4000, P5000, P5500, P6000, P6500, P7000   | 91E43-10800           |  |
| 358009     |             | Toyota                     | 02-5FD, FDU/20/23/25/28/30, 02-5FG28/30, 40-4FG20/25, 40-5FG20/23/25, 42-2FG, 4FG/20/25, 42-5FG, FGU/20/23/25, 5FD, FG/20/23/25/28/30, 8FDU, FGU20/25/30/32    | 43811-20540-71        |  |
| 358010     |             | Komatsu                    | FB20/25/30/30 SH-4, FD20/23/25/25S, 28, 30-11, 12, FG20/C/H/HT/S/T, 23/T, 25/C/H/HT/S/T, 28/T, 30/C/H/HT/S/T - 11, 12, 14                                      | 3EB-24-21210          |  |
| 358011     | 10.75 x 6   | Raymond                    | Swing Reach  | 838-010-001           | 9 Bolt Hub   |
| 358012     | 11.25 x 7   | Raymond                    | Pacer  | 223-001-152/002       | 8 Bolt Hub   |
| 358013     | 11.25 x 6   | Raymond                    | Pacer  | 223-001-153/002       | 8 Bolt Hub   |
| 358014     |             | Komatsu                    |  | 3EB-21-52320          |  |
| 358015     |             | Nissan                     |  | 43204-FJ101           |  |
| 370508     | 8 x 3.54    | Raymond                    | 3010 & 3020 Series Raymond Courier Automated Pallet Trucks   | 1133708               | 5 Bolt Hub   |
| 380030-144 |             | Hyster<br>Yale             | H25XMD, H30XMD, H35XMD, H40XMD<br>GC030, GC040, GDP030, GDP040, GLC030, GLP030, GLP040, GP030, GP040, GTP030   | 2021797<br>9063996-00 |  |
| 358016     |             | Hyster<br>Yale             | B60Z/80Z, C60Z/80Z, T5Z/T7Z, W20ZR/25ZC/30ZA/30ZC/30ZR/<br>40ZA/40ZC/60Z/65Z/80Z<br>MCW025/030/040, MPC060/080, MPE060/080, MPW060/<br>065/080, MRW020/030/040 | 524139975<br>2038719  | 5 Bolt Hub   |

# Hubs



## Crown Hubs

| Hub Part Number | Tire              | Steer/ Drive | Truck   |
|-----------------|-------------------|--------------|---|
| 121502          | 121501            | Drive        | RR/RD 5700/5200/5000                                    |
| 115025          | 079266            | Drive        | RR 3000   |
| 087391          | 079266            | Drive        | SP 3000/3200/3500/3400<br>3 wheel/ 3400 4 wheel         |
| 113361          | 079494            | Drive        | PC 4500/ PE 4000/<br>PR 4500                            |
| 113362          | 074458            | Drive        | PC 4500/ PE 4000/<br>PR 4500                            |
| 127250          | 127251            | Drive        | WP 3000   |
| 162148          | 135906            | Drive        | RC 5500 New Hub<br>without center cap                   |
| 140692          | 135906            | Drive        | RC 5500 Original Hub                                    |
| 134825          | 107933            | Steer        | RC 5500   |
| 114981          | 114493            | Drive        | RC 3000   |
| 126267          | 126266            | Steer        | RC 3000   |
| 076752          | 076751            | Steer        | RC 3000   |
| 116561          | 077848            | Steer        | RC 3000   |
| 124300          | 137033            | Drive        | SC 4000/ SC 4500  |
| 124798          | 137216            | Drive        | SC 4000/ SC 4500  |
| 146015          | 137031            | Steer        | SC 4000/ SC 4500/<br>SC 5200                            |
| 162146          | 137033            | Drive        | SC 5200 New Hub<br>without center cap<br>(cushion only) |
| 147717          | 137033            | Drive        | SC 5200 Original Hub<br>(cushion only)                  |
| 121973          | 136019            | Drive        | FC 4000/ FC 4500  |
| 128375          | 136019/<br>137210 | Drive        | FC 4000/ FC 4500/ C5<br>Cushion                         |
| 117444          | 135906/<br>136162 | Steer        | FC 4000/ FC 4500/ C5<br>Cushion                         |
| 138111          | 141058            | Steer        | C5 Cushion  |
| 140796          | 136019/<br>137210 | Drive        | C5 Cushion  |

## Tire Press

### 150 Ton Tire Press\*

Part Number - 300140

Ram: 17 IPM; Stroke: 18"



- Guarding for motor and power unit
- 3 LED lights
- Motor: 10 hp
- Ram Speed - Advance: 17 IPM
- Ram Speed - Return: Gravity
- Width Between Uprights: 36"
- Maximum Daylight: 36"
- Ram Travel: 18" - Limit switch stops ram at end
- Platen Diameter: 25"
- Overall Height: 80"
- Floor Space: 57" x 43"
- Weight: 3000+ lbs.
- Large ram provides platen stability and longer seal life
- Upper movable head channel provides travel for easy set-up
- Removable pins allow head channel to be set in four different positions
- Pressing rings in diameters and face widths for all standard tire sizes

\* Available only to customers in USA

⚠ WARNING: Cancer - [www.P65Warnings.ca.gov](http://www.P65Warnings.ca.gov)

## Tire Pressing Rings

| Part Number * | Description | Ring Size         |                      |                   | Tire Size           |                                  |                  |
|---------------|-------------|-------------------|----------------------|-------------------|---------------------|----------------------------------|------------------|
|               |             | O.D. (in.)        | Width/<br>Face (in.) | I.D. (in.)        | O.D. (in.)          | Width/<br>Face (in.)             | I.D. (in.)       |
| 300140-001    | Tire Ring   | 4 $\frac{7}{8}$   | 8                    | 4 $\frac{1}{8}$   | 9-10 $\frac{1}{2}$  | 5-7                              | 5                |
| 300140-002    | Tire Ring   | 6 $\frac{1}{8}$   | 8                    | 5 $\frac{3}{8}$   | 10                  | 3-7                              | 6 $\frac{1}{4}$  |
| 300140-003    | Tire Ring   | 6 $\frac{3}{8}$   | 10                   | 5 $\frac{5}{8}$   | 10-10 $\frac{1}{2}$ | 5-7                              | 6 $\frac{1}{2}$  |
| 300140-004    | Tire Ring   | 7 $\frac{3}{4}$   | 7                    | 7                 | 12-14               | 4 $\frac{1}{2}$ -5 $\frac{1}{2}$ | 8                |
| 300140-018    | Tire Ring   | 9 $\frac{7}{16}$  | 7                    | 8 $\frac{3}{4}$   | 12-14               | 4 $\frac{1}{2}$ -5 $\frac{1}{2}$ | 9 $\frac{1}{2}$  |
| 300140-005    | Tire Ring   | 9 $\frac{7}{8}$   | 7                    | 9 $\frac{1}{8}$   | 15 $\frac{1}{2}$    | 5-6                              | 10               |
| 300140-006    | Tire Ring   | 10 $\frac{9}{16}$ | 8                    | 9 $\frac{9}{16}$  | 16                  | 4 $\frac{1}{2}$ -7               | 10 $\frac{1}{2}$ |
| 300140-007    | Tire Ring   | 11 $\frac{1}{8}$  | 9                    | 10 $\frac{9}{16}$ | 15-16 $\frac{1}{4}$ | 5-8                              | 11 $\frac{1}{4}$ |
| 300140-009    | Tire Ring   | 11 $\frac{1}{4}$  | 10                   | 11 $\frac{1}{8}$  | 17-18               | 4 $\frac{1}{2}$ -7               | 12 $\frac{1}{8}$ |
| 300140-010    | Tire Ring   | 11 $\frac{3}{8}$  | 11                   | 11 $\frac{1}{4}$  | 18                  | 8-9                              | 12 $\frac{1}{8}$ |
| 300140-011    | Tire Ring   | 14 $\frac{1}{8}$  | 10                   | 14 $\frac{1}{8}$  | 21                  | 5-7                              | 15               |
| 300140-012    | Tire Ring   | 14 $\frac{1}{4}$  | 11                   | 14 $\frac{1}{8}$  | 21                  | 8-9                              | 15               |
| 300140-013    | Tire Ring   | 15 $\frac{1}{8}$  | 10                   | 15 $\frac{1}{8}$  | 20-22               | 5-7                              | 16               |
| 300140-014    | Tire Ring   | 15 $\frac{1}{4}$  | 11                   | 15 $\frac{1}{8}$  | 20-22               | 8-9                              | 16               |
| 300140-015    | Tire Ring   | 19 $\frac{1}{8}$  | 15 $\frac{1}{2}$     | 19 $\frac{1}{8}$  | 26                  | 5-7                              | 20               |
| 300140-016    | Tire Ring   | 21 $\frac{1}{8}$  | 15 $\frac{1}{2}$     | 21 $\frac{1}{8}$  | 28                  | 12                               | 22               |
| 300140-017    | Tire Ring   | 23 $\frac{3}{8}$  | 15 $\frac{1}{2}$     | 22 $\frac{1}{2}$  | 45                  | 9 $\frac{1}{2}$                  | 24               |



\* Available only to customers in USA

⚠ WARNING: Cancer - [www.P65Warnings.ca.gov](http://www.P65Warnings.ca.gov)

## Tools



### Shore A Durometer

Part Number - 390223

Measures wheel and tire Shore A hardness.  
Test range: 0-100 HA.

Tread Reference Only



200



342



443



444



480, 481\*,  
490 & 491\*



482 & 492



484\*, 489\*,  
494\* & 499\*







486, 487\*,  
496 & 497\*



| Crown Part Number      | Size                  | Tire O.D. | Tire Width | Rim Width | Profile             | Notes           | Manufacturer        |
|------------------------|-----------------------|-----------|------------|-----------|---------------------|-----------------|---------------------|
| <b>Solid Resilient</b> |                       |           |            |           |                     |                 |                     |
| 355158-480-42          | 15 x 4.5-8 (125/75-8) | 14.80     | 4.50       | 3.00      | Traction            | Solid Resilient | Camso/ Solideal     |
| 355158-481-42          | 15 x 4.5-8 (125/75-8) | 14.80     | 4.50       | 3.00      | Traction            | Solid Resilient | Camso/ Solideal     |
| 355158-491-42          | 15 x 4.5-8 (125/75-8) | 14.80     | 4.50       | 3.00      | Traction - NM Grey  | Solid Resilient | Camso/ Solideal     |
| 155533-487-42          | 15 x 4.5-8 (125/75-8) | 14.80     | 4.50       | 3.00      | Traction            | Solid Resilient | Camso/ Solideal     |
| 155533-497-42          | 15 x 4.5-8 (125/75-8) | 14.80     | 4.50       | 3.00      | Traction - NM Grey  | Solid Resilient | Camso/ Solideal     |
| 155541-489-42          | 15 x 4.5-8 (125/75-8) | 14.84     | 4.76       | 3.00      | Traction            | Solid Resilient | Continental         |
| 155541-499-42          | 15 x 4.5-8 (125/75-8) | 14.84     | 4.76       | 3.00      | Traction - NM Cream | Solid Resilient | Continental         |
| 155537-487-42          | 18 x 7-8              | 17.80     | 6.00       | 4.33      | Traction            | Solid Resilient | Camso/ Solideal     |
| 155537-497-42          | 18 x 7-8              | 17.80     | 6.00       | 4.33      | Traction - NM Grey  | Solid Resilient | Camso/ Solideal     |
| 155545-489-42          | 18 x 7-8              | 17.87     | 6.14       | 4.33      | Traction            | Solid Resilient | Continental         |
| 155545-499-42          | 18 x 7-8              | 17.87     | 6.14       | 4.33      | Traction - NM Cream | Solid Resilient | Continental         |
| 355708-480-42          | 18 x 7-8              | 17.90     | 6.20       | 4.33      | Traction            | Solid Resilient | Camso/ Solideal     |
| 355708-481-42          | 18 x 7-8              | 17.90     | 6.20       | 4.33      | Traction            | Solid Resilient | Camso/ Solideal     |
| 355708-482-42          | 18 x 7-8              | 18.00     | 6.20       | 4.33      | Traction            | Solid Resilient | Monarch/ Trelleborg |
| 355708-491-42          | 18 x 7-8              | 17.90     | 6.20       | 4.33      | Traction - NM Grey  | Solid Resilient | Camso/ Solideal     |
| 355708-492-42          | 18 x 7-8              | 18.00     | 6.20       | 4.33      | Traction - NM Cream | Solid Resilient | Monarch/ Trelleborg |
| 355610-482-42          | 21 x 8-9              | 20.30     | 7.30       | 6.00      | Traction            | Solid Resilient | Monarch/ Trelleborg |
| 355610-496-42          | 21 x 8-9              | 20.40     | 7.40       | 6.00      | Traction - NM Grey  | Solid Resilient | Camso/ Solideal     |
| 355239-481-42          | 23 x 9-10             | 23.00     | 8.00       | 6.50      | Traction            | Solid Resilient | Camso/ Solideal     |
| 355239-482-42          | 23 x 9-10             | 23.00     | 7.90       | 6.50      | Traction            | Solid Resilient | Monarch/ Trelleborg |
| 355239-487-42          | 23 x 9-10             | 23.00     | 8.00       | 6.50      | Traction            | Solid Resilient | Camso/ Solideal     |
| 355239-491-42          | 23 x 9-10             | 23.00     | 8.00       | 6.50      | Traction - NM Grey  | Solid Resilient | Camso/ Solideal     |
| 355023-481-42          | 23 x 10-12            | 23.10     | 9.20       | 8.00      | Traction            | Solid Resilient | Camso/ Solideal     |
| 355023-482-42          | 23 x 10-12            | 23.00     | 9.50       | 8.00      | Traction            | Solid Resilient | Monarch/ Trelleborg |
| 355023-487-42          | 23 x 10-12            | 23.10     | 9.20       | 8.00      | Traction            | Solid Resilient | Camso/ Solideal     |
| 355023-491-42          | 23 x 10-12            | 23.10     | 9.20       | 8.00      | Traction - NM Grey  | Solid Resilient | Camso/ Solideal     |
| 355023-492-42          | 23 x 10-12            | 23.00     | 9.50       | 8.00      | Traction - NM Cream | Solid Resilient | Monarch/ Trelleborg |
| 355250-480-42          | 250-15                | 28.20     | 8.90       | 7.00      | Traction            | Solid Resilient | Camso/ Solideal     |
| 355250-481-42          | 250-15                | 28.20     | 8.90       | 7.00      | Traction            | Solid Resilient | Camso/ Solideal     |
| 355250-482-42          | 250-15                | 28.00     | 8.90       | 7.00      | Traction            | Solid Resilient | Monarch/ Trelleborg |
| 355250-491-42          | 250-15                | 28.20     | 8.90       | 7.00      | Traction - NM Grey  | Solid Resilient | Camso/ Solideal     |
| 355255-480-42          | 250-15                | 28.20     | 8.90       | 7.50      | Traction            | Solid Resilient | Camso/ Solideal     |
| 155539-487-42          | 200/50-10             | 18.10     | 7.50       | 6.50      | Traction            | Solid Resilient | Camso/ Solideal     |
| 155539-497-42          | 200/50-10             | 18.10     | 7.50       | 6.50      | Traction - NM Grey  | Solid Resilient | Camso/ Solideal     |
| 155547-489-42          | 200/50-10             | 17.80     | 7.72       | 6.50      | Traction            | Solid Resilient | Continental         |
| 155547-499-42          | 200/50-10             | 17.80     | 7.72       | 6.50      | Traction - NM Cream | Solid Resilient | Continental         |
| 355200-481-42          | 200/50-10             | 18.10     | 7.50       | 6.50      | Traction            | Solid Resilient | Camso/ Solideal     |
| 355200-482-42          | 200/50-10             | 18.00     | 7.80       | 6.50      | Traction            | Solid Resilient | Monarch/ Trelleborg |
| 355200-492-42          | 200/50-10             | 18.00     | 7.80       | 6.50      | Traction - NM Grey  | Solid Resilient | Monarch/ Trelleborg |
| 355400-381-42          | 4.00-8                | 16.00     | 4.80       | 3.75      | Traction- Rib       | Solid Resilient | Camso/ Solideal     |
| 355401-382-42          | 4.00-8                | 16.10     | 4.70       | 2.50      | Traction- Rib       | Solid Resilient | Monarch/ Trelleborg |
| 355500-480-42          | 5.00-8                | 17.70     | 4.80       | 3.00      | Traction            | Solid Resilient | Camso/ Solideal     |
| 355500-482-42          | 5.00-8                | 18.00     | 4.80       | 3.00      | Traction            | Solid Resilient | Monarch/ Trelleborg |
| 355500-484-42          | 5.00-8                | 17.99     | 5.00       | 3.00      | Traction            | Solid Resilient | Continental         |
| 355500-486-42          | 5.00-8                | 17.70     | 4.80       | 3.00      | Traction            | Solid Resilient | Camso/ Solideal     |
| 355500-490-42          | 5.00-8                | 17.70     | 4.80       | 3.00      | Traction - NM Grey  | Solid Resilient | Camso/ Solideal     |
| 355500-492-42          | 5.00-8                | 18.00     | 4.80       | 3.00      | Traction - NM Cream | Solid Resilient | Monarch/ Trelleborg |
| 355508-381-42          | 5.00-8                | 17.80     | 5.30       | 3.75      | Traction- Rib       | Solid Resilient | Camso/ Solideal     |
| 355508-482-42          | 5.00-8                | 18.00     | 6.00       | 3.75      | Traction            | Solid Resilient | Monarch/ Trelleborg |
| 156783-484-42          | 6.00-9                | 20.83     | 5.63       | 4.00      | Traction            | Solid Resilient | Continental         |
| 156783-485-42          | 6.00-9                | 21.40     | 5.90       | 4.00      | Traction            | Solid Resilient | Nex Tire            |
| 156783-487-42          | 6.00-9                | 20.60     | 5.43       | 4.00      | Traction            | Solid Resilient | Camso/ Solideal     |
| 156783-494-42          | 6.00-9                | 20.83     | 5.63       | 4.00      | Traction - NM Cream | Solid Resilient | Continental         |
| 156783-497-42          | 6.00-9                | 20.60     | 5.43       | 4.00      | Traction - NM Grey  | Solid Resilient | Camso/ Solideal     |
| 359609-200-42          | 6.00-9                | 20.43     | 5.35       | 4.00      | Traction            | Solid Resilient | Camso/ Solideal     |
| 355609-480-42          | 6.00-9                | 20.60     | 5.43       | 4.00      | Traction            | Solid Resilient | Camso/ Solideal     |
| 355609-481-42          | 6.00-9                | 20.60     | 5.43       | 4.00      | Traction            | Solid Resilient | Camso/ Solideal     |
| 355609-482-42          | 6.00-9                | 20.60     | 5.60       | 4.00      | Traction            | Solid Resilient | Monarch/ Trelleborg |
| 355609-492-42          | 6.00-9                | 20.60     | 5.60       | 4.00      | Traction - NM Cream | Solid Resilient | Monarch/ Trelleborg |
| 355609-486-42          | 6.00-9                | 20.60     | 5.43       | 4.00      | Traction            | Solid Resilient | Camso/ Solideal     |
| 355609-490-42          | 6.00-9                | 20.60     | 5.43       | 4.00      | Traction - NM Grey  | Solid Resilient | Camso/ Solideal     |

\*These tires include the built-in lock ring (Quick/SIT Tires) – 481, 484, 487, 489, 491, 494, 497 & 499



| Crown Part Number                  | Size   | Tire O.D. | Tire Width | Rim Width | Profile             | Notes           | Manufacturer        |
|------------------------------------|--|-----------|------------|-----------|---------------------|-----------------|---------------------|
| <b>Solid Resilient (continued)</b> |  |           |            |           |                     |                 |                     |
| 156781-484-42                      | 6.50-10  | 22.68     | 6.38       | 5.00      | Traction            | Solid Resilient | Continental         |
| 156781-485-42                      |  6.50-10                            | 23.70     | 6.20       | 5.00      | Traction            | Solid Resilient | Nex Tire            |
| 156781-487-42                      | 6.50-10  | 22.30     | 6.40       | 5.00      | Traction            | Solid Resilient | Camso/ Solideal     |
| 156781-494-42                      | 6.50-10  | 22.68     | 6.38       | 5.00      | Traction - NM Cream | Solid Resilient | Continental         |
| 156781-497-42                      | 6.50-10  | 22.30     | 6.40       | 5.00      | Traction - NM Grey  | Solid Resilient | Camso/ Solideal     |
| 359650-200-42                      | 6.50-10  | 22.28     | 6.02       | 5.00      | Traction            | Solid Resilient | Camso/ Solideal     |
| 355650-381-41                      | 6.50-10  | 22.30     | 6.20       | 5.00      | Smooth              | Solid Resilient | Camso/ Solideal     |
| 355650-480-42                      | 6.50-10  | 22.30     | 6.40       | 5.00      | Traction            | Solid Resilient | Camso/ Solideal     |
| 355650-481-42                      | 6.50-10  | 22.30     | 6.40       | 5.00      | Traction            | Solid Resilient | Camso/ Solideal     |
| 355650-482-42                      | 6.50-10  | 22.60     | 6.70       | 5.00      | Traction            | Solid Resilient | Monarch/ Trelleborg |
| 355650-486-42                      | 6.50-10  | 22.30     | 6.40       | 5.00      | Traction            | Solid Resilient | Camso/ Solideal     |
| 355650-490-42                      | 6.50-10  | 22.30     | 6.40       | 5.00      | Traction - NM Grey  | Solid Resilient | Camso/ Solideal     |
| 355650-492-42                      | 6.50-10  | 22.60     | 6.70       | 5.00      | Traction - NM Cream | Solid Resilient | Monarch/ Trelleborg |
| 355650-496-42                      | 6.50-10  | 22.30     | 6.40       | 5.00      | Traction - NM Grey  | Solid Resilient | Camso/ Solideal     |
| 156779-484-42                      | 7.00-12  | 25.78     | 6.81       | 5.00      | Traction            | Solid Resilient | Continental         |
| 156779-485-42                      |  7.00-12                            | 27.36     | 6.80       | 5.00      | Traction            | Solid Resilient | Nex Tire            |
| 156779-487-42                      | 7.00-12  | 25.60     | 6.60       | 5.00      | Traction            | Solid Resilient | Camso/ Solideal     |
| 156779-494-42                      | 7.00-12  | 25.87     | 6.81       | 5.00      | Traction - NM Cream | Solid Resilient | Continental         |
| 156779-497-42                      | 7.00-12  | 25.60     | 6.60       | 5.00      | Traction - NM Grey  | Solid Resilient | Camso/ Solideal     |
| 355712-480-42                      | 7.00-12  | 25.70     | 6.80       | 5.00      | Traction            | Solid Resilient | Camso/ Solideal     |
| 355712-481-42                      | 7.00-12  | 25.70     | 6.80       | 5.00      | Traction            | Solid Resilient | Camso/ Solideal     |
| 355712-482-42                      | 7.00-12  | 25.60     | 6.70       | 5.00      | Traction            | Solid Resilient | Monarch/ Trelleborg |
| 355712-490-42                      | 7.00-12  | 25.70     | 6.80       | 5.00      | Traction - NM Grey  | Solid Resilient | Camso/ Solideal     |
| 355712-492-42                      | 7.00-12  | 25.60     | 6.70       | 5.00      | Traction - NM Cream | Solid Resilient | Monarch/ Trelleborg |
| 355712-486-42                      | 7.00-12  | 25.60     | 6.60       | 5.00      | Traction            | Solid Resilient | Camso/ Solideal     |
| 359712-200-42                      | 7.00-12  | 25.39     | 6.50       | 5.00      | Traction            | Solid Resilient | Camso/ Solideal     |
| 355715-200-42                      | 7.00-15  | 28.39     | 7.28       | 5.50      | Traction            | Solid Resilient | Camso/ Solideal     |
| 355715-480-42                      | 7.00-15  | 28.70     | 7.00       | 5.50      | Traction            | Solid Resilient | Camso/ Solideal     |
| 355715-482-42                      | 7.00-15  | 28.80     | 7.10       | 5.50      | Traction            | Solid Resilient | Monarch/ Trelleborg |
| 156777-484-42                      | 8.15-15 or 28 x 9-15 or 225/75-15  | 27.28     | 8.50       | 7.00      | Traction            | Solid Resilient | Continental         |
| 156777-485-42                      |  8.15-15 or 28 x 9-15 or 225/75-15 | 28.72     | 8.94       | 7.00      | Traction            | Solid Resilient | Nex Tire            |
| 156777-487-42                      | 8.15-15 or 28 x 9-15 or 225/75-15  | 27.00     | 8.60       | 7.00      | Traction            | Solid Resilient | Camso/ Solideal     |
| 156777-494-42                      | 8.15-15 or 28 x 9-15 or 225/75-15  | 27.28     | 8.50       | 7.00      | Traction - NM Cream | Solid Resilient | Continental         |
| 156777-497-42                      | 8.15-15 or 28 x 9-15 or 225/75-15  | 27.00     | 8.60       | 7.00      | Traction - NM Grey  | Solid Resilient | Camso/ Solideal     |
| 355815-480-42                      | 8.15-15 or 28 x 9-15 or 225/75-15  | 27.00     | 8.60       | 7.00      | Traction            | Solid Resilient | Camso/ Solideal     |
| 355815-481-42                      | 8.15-15 or 28 x 9-15 or 225/75-15  | 27.00     | 8.60       | 7.00      | Traction            | Solid Resilient | Camso/ Solideal     |
| 355815-482-42                      | 8.15-15 or 28 x 9-15 or 225/75-15  | 27.30     | 8.90       | 7.00      | Traction            | Solid Resilient | Monarch/ Trelleborg |
| 355815-486-42                      | 8.15-15 or 28 x 9-15 or 225/75-15  | 27.00     | 8.60       | 7.00      | Traction            | Solid Resilient | Camso/ Solideal     |
| 355815-490-42                      | 8.15-15 or 28 x 9-15 or 225/75-15  | 27.00     | 8.60       | 7.00      | Traction - NM Grey  | Solid Resilient | Camso/ Solideal     |
| 355815-492-42                      | 8.15-15 or 28 x 9-15 or 225/75-15  | 27.30     | 8.90       | 7.00      | Traction - NM Cream | Solid Resilient | Monarch/ Trelleborg |
| 359815-200-42                      | 8.15-15 or 28 x 9-15 or 225/75-15  | 26.81     | 8.31       | 7.00      | Traction            | Solid Resilient | Camso/ Solideal     |
| 355750-482-42                      | 7.50-15  | 29.30     | 7.60       | 6.50      | Traction            | Solid Resilient | Monarch/ Trelleborg |
| 355825-482-42                      | 8.25-15  | 31.80     | 8.20       | 5.50      | Traction            | Solid Resilient | Monarch/ Trelleborg |
| 355826-480-42                      | 8.25-15  | 29.60     | 7.80       | 6.50      | Traction            | Solid Resilient | Camso/ Solideal     |
| 355826-481-42                      | 8.25-15  | 29.60     | 7.80       | 6.50      | Traction            | Solid Resilient | Camso/ Solideal     |
| 355826-482-42                      | 8.25-15  | 31.80     | 8.20       | 6.50      | Traction            | Solid Resilient | Monarch/ Trelleborg |
| 355826-486-42                      | 8.25-15  | 32.00     | 8.30       | 6.50      | Traction            | Solid Resilient | Camso/ Solideal     |
| 355826-487-42                      | 8.25-15  | 32.00     | 8.30       | 6.50      | Traction            | Solid Resilient | Camso/ Solideal     |
| 355826-490-42                      | 8.25-15  | 29.60     | 7.80       | 6.50      | Traction - NM Grey  | Solid Resilient | Camso/ Solideal     |
| 355300-480-42                      | 3.00-15  | 32.10     | 10.10      | 8.00      | Traction            | Solid Resilient | Camso/ Solideal     |
| 355300-482-42                      | 3.00-15  | 32.00     | 10.00      | 8.00      | Traction            | Solid Resilient | Monarch/ Trelleborg |
| 355920-381-42                      | 9.00-20  | 38.30     | 8.80       | 7.00      | Traction            | Solid Resilient | Camso/Solideal      |
| 355920-482-42                      | 9.00-20  | 38.35     | 8.66       | 6.50      | Traction            | Solid Resilient | Monarch/ Trelleborg |
| 355122-480-42                      |  12.00-20                         | 42.90     | 11.10      | 8.50      | Traction            | Solid Resilient | Camso/ Solideal     |
| 148737-487-42                      | 27 x 10-12   | 26.80     | 9.60       | 8.00      | Traction            | Solid Resilient | Camso/ Solideal     |
| 148737-497-42                      | 27 x 10-12 (250/75-12)   | 26.80     | 9.60       | 8.00      | Traction - NM Grey  | Solid Resilient | Camso/ Solideal     |
| 355027-481-42                      | 27 x 10-12   | 26.80     | 9.70       | 8.00      | Traction            | Solid Resilient | Camso/ Solideal     |
| 355027-491-42                      | 27 x 10-12   | 26.80     | 9.70       | 8.00      | Traction - NM Grey  | Solid Resilient | Camso/ Solideal     |
| 148740-487-42                      | 28 x 12.5-15 (355/45-15)   | 27.10     | 11.50      | 9.75      | Traction            | Solid Resilient | Camso/ Solideal     |
| 148740-497-42                      | 28 x 12.5-15 (355/45-15)   | 27.10     | 11.50      | 9.75      | Traction - NM Grey  | Solid Resilient | Camso/ Solideal     |
| 155535-487-42                      | 140/55-9   | 14.80     | 5.10       | 4.00      | Traction            | Solid Resilient | Camso/ Solideal     |
| 155535-497-42                      | 140/55-9   | 14.80     | 5.10       | 4.00      | Traction - NM Grey  | Solid Resilient | Camso/ Solideal     |
| 155543-489-42                      | 140/55-9   | 14.84     | 5.16       | 4.00      | Traction            | Solid Resilient | Continental         |
| 155543-499-42                      | 140/55-9   | 14.84     | 5.16       | 4.00      | Traction - NM Cream | Solid Resilient | Continental         |
| 355140-481-42                      | 140/55-9   | 14.90     | 5.10       | 4.00      | Traction            | Solid Resilient | Camso/ Solideal     |

\*These tires include the built-in lock ring (Quick/SIT Tires) – 481, 484, 487, 489, 491, 494, 497 & 499





## Resilient/Pneumatic Tires

| Crown Part Number    | Size                 | Tire O.D. | Tire Width | Rim Width | Ply | Profile  | Notes         | Manufacturer        |
|----------------------|----------------------|-----------|------------|-----------|-----|----------|---------------|---------------------|
| <b>Air Pneumatic</b> |                      |           |            |           |     |          |               |                     |
| 355250-444-42-16     | 250-15 (250/70-15)   | 28.90     | 9.40       | 7.50      | 16  | Traction | Air Pneumatic | Camso/ Solideal     |
| 350500-342-42        | 5.00-8               | 18.70     | 5.70       | 3.00      | 10  | Traction | Air Pneumatic | Monarch/ Trelleborg |
| 355508-444-42-08     | 5.00-8               | 18.20     | 5.00       | 3.00      | 8   | Traction | Air Pneumatic | Camso/ Solideal     |
| 355609-342-42        | 6.00-9               | 21.38     | 6.30       | 4.00      | 12  | Traction | Air Pneumatic | Monarch/ Trelleborg |
| 163060-444-42-12     | 6.00-9               | 21.10     | 6.42       | 4.00      | 12  | Traction | Air Pneumatic | Camso/ Solideal     |
| 355609-444-42-10     | 6.00-9               | 20.71     | 5.94       | 4.00      | 10  | Traction | Air Pneumatic | Camso/ Solideal     |
| 163059-444-42-14     | 6.50-10              | 23.23     | 7.28       | 5.00      | 14  | Traction | Air Pneumatic | Camso/ Solideal     |
| 355650-444-42-10     | 6.50-10              | 23.11     | 6.69       | 5.00      | 10  | Traction | Air Pneumatic | Camso/ Solideal     |
| 163058-444-42-16     | 7.00-12              | 26.30     | 7.50       | 5.00      | 16  | Traction | Air Pneumatic | Camso/ Solideal     |
| 355712-342-42        | 7.00-12              | 27.10     | 7.80       | 5.00      | 14  | Traction | Air Pneumatic | Monarch/ Trelleborg |
| 355712-444-42-12     | 7.00-12              | 26.57     | 7.64       | 5.00      | 12  | Traction | Air Pneumatic | Camso/ Solideal     |
| 355712-444-42-14     | 7.00-12              | 26.69     | 7.24       | 5.00      | 14  | Traction | Air Pneumatic | Camso/ Solideal     |
| 355715-342-42        | 7.00-15              | 30.10     | 8.10       | 5.50      | 14  | Traction | Air Pneumatic | Monarch/ Trelleborg |
| 355715-444-42-14     | 7.00-15              | 30.00     | 7.95       | 5.50      | 14  | Traction | Air Pneumatic | Camso/ Solideal     |
| 355716-444-42-12     | 7.50-16              | 31.70     | 7.60       | 6.00      | 12  | Traction | Air Pneumatic | Camso/ Solideal     |
| 163057-444-42-14     | 8.15-15 or 28 x 9-15 | 28.11     | 8.78       | 7.00      | 14  | Traction | Air Pneumatic | Camso/ Solideal     |
| 355825-342-42        | 8.25-15              | 33.11     | 9.72       | 6.50      | 14  | Traction | Air Pneumatic | Monarch/ Trelleborg |
| 355825-443-42        | 8.25-15              | 33.10     | 9.70       | 6.50      | 14  | Traction | Air Pneumatic | Camso/ Solideal     |
| 355825-444-42-14     | 8.25-15              | 33.23     | 9.13       | 6.50      | 14  | Traction | Air Pneumatic | Camso/ Solideal     |
| 355920-342-42-14     | 9.00-20              | 39.96     | 10.43      | 7.00      | 14  | Traction | Air Pneumatic | Monarch/ Trelleborg |
| 355920-444-42-14     | 9.00-20              | 41.20     | 11.30      | 7.00      | 14  | Traction | Air Pneumatic | Camso/ Solideal     |
| 355300-444-42-18     | 300-15 (315/70-15)   | 32.48     | 11.50      | 8.00      | 18  | Traction | Air Pneumatic | Camso/ Solideal     |
| 355300-443-42-18     | 300-15 (315/70-15)   | 33.50     | 10.90      | 8.00      | 18  | Traction | Air Pneumatic | Camso/ Solideal     |
| 355032-443-42        | 32x12.1-15           | 31.70     | 12.40      | 9.75      | 24  | Traction | Air Pneumatic | Camso/ Solideal     |

Please note: All Air Pneumatics include the Tire, Flaps, and Tubes.

## Tubes

| Crown Part | Tire Size | Manufacturer | Crown Part | Tire Size | Manufacturer | Crown Part | Tire Size | Manufacturer |
|------------|-----------|--------------|------------|-----------|--------------|------------|-----------|--------------|
| 315000-250 | 2.50 x 15 | Camso        | 136247     | 6.00 x 9  | Camso        | 315000-715 | 7.00 x 15 | Camso        |
| 315000-408 | 4.00 x 8  | Camso        | 315000-650 | 6.50 x 10 | Camso        | 315000-815 | 8.15 x 15 | Camso        |
| 315000-508 | 5.00 x 8  | Camso        | 136243     | 7.00 x 12 | Camso        |            |           |              |

## Flaps

| Crown Part | Tire Size       | Manufacturer |
|------------|-----------------|--------------|
| 141518-001 | 400/500/570 x 8 | Camso        |
| 141518-002 | 16 x 6-8        | Camso        |

## Rims

| Crown Part | Rim Size  | Tire Size              | Manufacturer | Crown Part | Rim Size  | Tire Size          | Manufacturer |
|------------|-----------|------------------------|--------------|------------|-----------|--------------------|--------------|
| 153008*    | 3.00 D-8  | 15x4.5-8 3.0"          | Camso        | 157348**   | 5.00 F-10 | 6.50-10 5.0"       | Continental  |
| 153995**   | 3.00 D-8  | 125/75-8 3.0"          | Continental  | 149641     | 5.00 S-12 | 7.00-12 5.0"       | Camso        |
| 136246     | 4.00 E-9  | 6.00-9 4.0"            | Camso        | 156785*    | 5.00S-12  | 7.00-12 5.0"       | Camso        |
| 153998**   | 4.00 E-9  | 140/55-9 4.0"          | Continental  | 157351**   | 5.00 S-12 | 7.00-12 5.0"       | Continental  |
| 157342**   | 4.00 E-9  | 6.00-9 4.0"            | Continental  | 152570*    | 6.50 F-10 | 200/50-10 6.5"     | Camso        |
| 152564*    | 4.00 E-9  | 140/55-9 4.0"          | Camso        | 154004**   | 6.50 F-10 | 200/50-10 6.5"     | Continental  |
| 156792*    | 4.00 E-9  | 6.00-9 4.0"            | Camso        | 157345**   | 7.00-15   | 225/75-15 7.0"     | Continental  |
| 152567*    | 4.33 R-8  | 18x7-8 4.33"           | Camso        | 156784*    | 7.00-15   | 28x9-15 7.0"       | Camso        |
| 154001**   | 4.33 R-8  | 18x7-8 4.33"           | Continental  | 142934     | 7.10-15   | 28x9-15 7.0"       | Camso        |
| 113041     | 4.33 R-8  | 16x6-8, 17x7-8, 18x7-8 | Trelleborg   | 113042     | 8.00 G-12 | 23x10-12, 27x10-12 | Trelleborg   |
| 156786*    | 5.00 F-10 | 6.50-10 5.0"           | Camso        | 148738*    | 8.00 G-12 | 27x10-12 8.0"      | Camso        |
| 143317     | 5.00 F-10 | 6.50-10 5.0"           | Camso        | 148741*    | 9.75-15   | 355/45-15 9.75"    | Camso        |

\*Quick Tire Only (lock ring imbedded into the tire)

\*\*SIT Tire Only (lock ring imbedded into the tire)

# Tire Chains

## Forklift Tire Chains

| Crown Part Number - Pair | Tire Sizes |             |           |            |         | Weight Per Pair |
|--------------------------|------------|-------------|-----------|------------|---------|-----------------|
|                          |            |             |           |            |         |                 |
| 355900-001               | 6.50-10    |             |           |            |         | 15              |
| 355900-007               | 6.00x9     | 23x9-10     | 225/75-10 |            |         | 17              |
| 355900-002               | 7.00-12    | 7.50-10     | 23x10-12  | 250/60-12  |         | 19              |
| 355900-003               | 7.00-15    | 28x9-15     | 8.15-15   | 225/75-15  | 29x8-15 | 20              |
| 355900-004               | 7.50-15    |             |           |            |         | 27              |
| 355900-005               | 250-15     | 250/70-15   |           |            |         | 22              |
| 355900-006               | 8.25-15    | 7.50-15(32) |           |            |         | 28              |
| 355900-008               | 27x10-12   | 250/75-12   |           |            |         | 25              |
| 355900-009               | 27x12x8    |             |           |            |         | 28              |
| 355900-010               | 300-15     | 315/70-15   | 355/45-15 | 28x12.5-15 |         | 30              |

⚠️WARNING: Cancer and reproductive harm - [www.P65Warnings.ca.gov](http://www.P65Warnings.ca.gov)



### Forklift Tire Chains

- Square 4-link alloy cross chains



### Light Truck Tire Chains

- 5.5mm square straight link alloy chains
- Increased durability and traction
- Reversible for extended use on both sides

## Light Truck Tire Chains

| Crown Part Number - Pair | Tire Sizes   |   |  |  |  |  | Weight Per Pair |
|--------------------------|--|---|--|--|--|--|-----------------|
|                          |  |   |  |  |  |  |                 |
| 355901-001               | 215/75R14LT<br>9-14.5MH                                    | P225/75R15<br>P235/75R15                          | 6.50-16LT<br>205R16                                    | 8.00-16.5<br>P235/65R17                                | H78-15LT<br>225/75R16LT                              | 215/75R15LT  | 21              |
| 355901-002               | 7.00-15TR<br>7.50-15LT<br>P275/60R15                       | 245/75R15LT<br>7.00-16LT<br>P235/70R16            | P245/75R16<br>215/80R16LT<br>215/85R16LT               | 245/70R16LT<br>255/65R16<br>8.75-16.5                  | 235/75R15LT<br>P245/70R16<br>235/75R16LT             | 8.50-17.5<br>215/70R17.5<br>8-17.5                       | 23              |
| 355901-003               | NR78-15<br>7.50-15TR                                       | 275/60R15LT<br>LR78-16LT                          | 235/85R16LT<br>245/75R16LT                             | 7.00-17LT<br>215/75R17.5LT                             | P265/75R15<br>9.50-16.5                              | 7.50-16LT  | 25              |
| 355901-004               | KR78-15<br>31x10.5-15LT                                    | 10-15LT<br>255/70R16LT                            | 265/75R15LT  | 245/85R16LT  | 8.25-15  | 265/70R15LT  | 26              |
| 355901-005               | PR78-15<br>8.25-15TR<br>11-15LT<br>31x11.5-15LT<br>10-17.5 | 33x13.5-15<br>34x9.50-15<br>PR78-16<br>P265/70R16 | 265/75R16LT<br>275/70R16LT<br>32x11.5x16<br>33x13.5-16 | 12-16.5LT<br>31x10.5-16.5<br>P275/60R17<br>265/70R17LT | 28x12.5-15<br>32x11.5-15LT<br>255/85R16LT<br>34x9x16 | 225/70R19.5LT<br>245/70R19.5LT<br>275/55R20<br>275/60R20 | 27              |
| 355901-006               | 12-15LT<br>P315/70R15<br>31x13.50-15                       | 33x14x15<br>33x14.5-15<br>35x13.5-15              | 11L16<br>285/75R16LT<br>295/75R16                      | 35x13.5-16<br>36x13x16<br>33x12.50R16.5                | 32x12.50R15<br>35x14.5-15<br>305/85R16LT             | 325/60R18<br>35x12.5-17<br>300-15                        | 31              |

⚠️WARNING: Cancer and reproductive harm - [www.P65Warnings.ca.gov](http://www.P65Warnings.ca.gov)

# Rubber Tires by Size

Continued ▶

Tread Reference Only



201 & 211  
421 & 431



301 & 311  
305 & 315



302 & 312  
427 & 429



307 & 317



404 & 414



408 & 418

### Profile/Compound Key

|    |               |
|----|---------------|
| CG | Center Groove |
| DS | Diamond Sipe  |
| RS | Router Sipe   |
| SM | Smooth        |
| FG | Fiberglass    |

### Manufacturer Key

|    |                    |
|----|--------------------|
| CO | Continental        |
| CS | Camso/Solideal     |
| MO | Monarch/Trelleborg |
| ML | Millennium         |
| RR | Roadrunner         |
| SU | Superior           |

| O.D.              | Width | I.D.  | Profile  | Compound        | Crown Part Number | Manuf. |
|-------------------|-------|-------|----------|-----------------|-------------------|--------|
| <b>5.50 O.D.</b>  |       |       |          |                 |                   |        |
| 5.50              | 5.00  | 2.190 | SM       | Rubber          | 370355            | SU     |
| <b>7.00 O.D.</b>  |       |       |          |                 |                   |        |
| 7.00              | 4.00  | 2.441 | SM       | Rubber          | 350067-407        | ML     |
| <b>8.50 O.D.</b>  |       |       |          |                 |                   |        |
| 8.50              | 4.00  | 4.000 | SM       | Rubber          | 071566-001        | MO     |
| 8.50              | 4.00  | 4.000 | RS       | Rubber          | 071566-002        | MO     |
| <b>9.00 O.D.</b>  |       |       |          |                 |                   |        |
| 9.00              | 5.00  | 5.000 | SM       | Rubber          | 076751-001        | MO     |
| 9.00              | 5.00  | 5.000 | SM       | Rubber NM Cream | 076751-003        | MO     |
| 9.00              | 5.00  | 5.000 | SM       | Rubber          | 350049-408-41     | CS     |
| 9.00              | 5.00  | 5.000 | SM       | Rubber NM Grey  | 350049-316-41     | CS     |
| <b>9.84 O.D.</b>  |       |       |          |                 |                   |        |
| 9.84              | 3.35  | 7.480 | RS       | Rubber          | 808185            |        |
| <b>10.00 O.D.</b> |       |       |          |                 |                   |        |
| 10.00             | 3.00  | 6.250 | SM       | Rubber          | 350004-303-41     | ML     |
| 10.00             | 4.00  | 6.500 | SM       | Rubber          | 075714            | MO     |
| 10.00             | 4.00  | 6.500 | SM       | Rubber NM Cream | 127251-002        | MO     |
| 10.00             | 4.00  | 6.500 | DS       | Rubber          | 127251-003        | MO     |
| 10.00             | 4.00  | 6.500 | SM       | Rubber          | 127251-201-41     | RR     |
| 10.00             | 4.00  | 6.500 | Traction | Rubber          | 127251-201-42     | RR     |
| 10.00             | 4.00  | 6.500 | DS       | Rubber          | 127251-301-05     | CS     |
| 10.00             | 4.00  | 6.500 | SM       | Rubber          | 127251-301-41     | CS     |
| 10.00             | 4.00  | 6.500 | DS       | Rubber NM Grey  | 127251-311-05     | CS     |
| 10.00             | 4.00  | 6.500 | SM       | Rubber NM Grey  | 127251-311-41     | CS     |
| 10.00             | 4.00  | 6.500 | SM       | Rubber          | 127251-407-41     | ML     |
| 10.00             | 4.00  | 6.500 | DS       | FG              | 127251-421-05     | RR     |
| 10.00             | 4.00  | 6.500 | SM       | FG              | 127251-421-41     | RR     |
| 10.00             | 4.00  | 6.500 | Traction | FG              | 127251-421-42     | RR     |
| 10.00             | 4.00  | 6.500 | SM       | Walnut          | 127251-429-41     | ML     |
| 10.00             | 4.00  | 6.500 | SM       | Rubber          | 357251-404-41     | CO     |
| 10.00             | 4.00  | 6.500 | SM       | Rubber NM Cream | 357251-414-41     | CO     |
| 10.00             | 4.00  | 6.500 | SM       | Rubber NM Grey  | 357251-418-41     | CS     |
| 10.00             | 4.00  | 6.500 | SM       | FG              | 357251-421-41     | RR     |
| 10.00             | 4.00  | 6.500 | SM       | Rubber          | 357251-450-41     | CS     |
| 10.00             | 4.00  | 6.500 | SM       | Rubber NM Grey  | 357251-460-41     | CS     |
| 10.00             | 4.75  | 6.500 | SM       | Rubber          | 350005-303-41     | ML     |
| 10.00             | 4.75  | 6.500 | Traction | Rubber          | 350005-303-42     | ML     |
| 10.00             | 4.75  | 6.500 | SM       | Rubber NM Cream | 350005-313-41     | ML     |
| 10.00             | 4.75  | 6.500 | SM       | Rubber          | 350005-408-41     | CS     |
| 10.00             | 4.75  | 6.500 | SM       | FG              | 350005-428-41     | ML     |
| 10.00             | 4.75  | 6.500 | Traction | FG              | 350005-428-42     | ML     |
| 10.00             | 5.00  | 6.500 | SM       | Rubber          | 042028-001        | MO     |
| 10.00             | 5.00  | 6.500 | RS       | Rubber          | 042028-003        | MO     |
| 10.00             | 5.00  | 6.500 | SM       | Rubber NM Cream | 042028-004        | MO     |
| 10.00             | 5.00  | 6.500 | DS       | Rubber          | 042028-006        | MO     |
| 10.00             | 5.00  | 6.500 | SM       | Rubber          | 135907-301-41     | CS     |
| 10.00             | 5.00  | 6.500 | CG       | Rubber          | 135907-301-42     | CS     |
| 10.00             | 5.00  | 6.500 | SM       | Rubber          | 135907-305-41     | CS     |
| 10.00             | 5.00  | 6.500 | CG       | Rubber          | 135907-305-42     | CS     |
| 10.00             | 5.00  | 6.500 | SM       | Rubber NM Grey  | 135907-311-41     | CS     |
| 10.00             | 5.00  | 6.500 | CG       | Rubber NM Grey  | 135907-311-42     | CS     |

| O.D.              | Width | I.D.  | Profile   | Compound          | Crown Part Number | Manuf. |
|-------------------|-------|-------|-----------|-------------------|-------------------|--------|
| 10.00             | 5.00  | 6.500 | SM        | Rubber NM Grey    | 135907-315-41     | CS     |
| 10.00             | 5.00  | 6.500 | CG        | Rubber NM Grey    | 135907-315-42     | CS     |
| 10.00             | 5.00  | 6.500 | SM        | Rubber            | 350007-201-41     | RR     |
| 10.00             | 5.00  | 6.500 | Traction  | Rubber            | 350007-201-42     | RR     |
| 10.00             | 5.00  | 6.500 | SM        | Rubber NM Dk Grey | 350007-211-41     | RR     |
| 10.00             | 5.00  | 6.500 | Traction  | Rubber NM Dk Grey | 350007-211-42     | RR     |
| 10.00             | 5.00  | 6.500 | RS        | Rubber            | 350007-302-03     | MO     |
| 10.00             | 5.00  | 6.500 | SM        | Rubber            | 350007-303-41     | ML     |
| 10.00             | 5.00  | 6.500 | Traction  | Rubber            | 350007-303-42     | ML     |
| 10.00             | 5.00  | 6.500 | SM        | Rubber NM Cream   | 350007-313-41     | ML     |
| 10.00             | 5.00  | 6.500 | SM        | Rubber            | 350007-404-41     | CO     |
| 10.00             | 5.00  | 6.500 | Traction  | Rubber            | 350007-408-42     | CS     |
| 10.00             | 5.00  | 6.500 | SM        | Rubber NM Cream   | 350007-414-41     | CO     |
| 10.00             | 5.00  | 6.500 | SM        | Rubber NM Grey    | 350007-418-41     | CS     |
| 10.00             | 5.00  | 6.500 | Traction  | Rubber NM Grey    | 350007-418-42     | CS     |
| 10.00             | 5.00  | 6.500 | Thin Sipe | FG                | 350007-421-04     | RR     |
| 10.00             | 5.00  | 6.500 | SM        | FG                | 350007-421-41     | RR     |
| 10.00             | 5.00  | 6.500 | Traction  | FG                | 350007-421-42     | RR     |
| 10.00             | 5.00  | 6.500 | SM        | Wire              | 350007-423-41     | ML     |
| 10.00             | 5.00  | 6.500 | SM        | FG Severe Duty    | 350007-424-41     | ML     |
| 10.00             | 5.00  | 6.500 | SM        | Walnut            | 350007-429-41     | ML     |
| 10.00             | 5.00  | 6.500 | SM        | Walnut NM White   | 350007-439-41     | ML     |
| 10.00             | 5.00  | 6.500 | SM        | Rubber            | 350007-450-41     | CS     |
| 10.00             | 5.00  | 6.500 | SM        | Rubber NM Grey    | 350007-460-41     | CS     |
| 10.00             | 5.00  | 6.500 | SM        | Rubber            | 350202-201-41     | RR     |
| 10.00             | 5.00  | 6.500 | Traction  | Rubber            | 350202-201-42     | RR     |
| 10.00             | 5.00  | 6.500 | DS        | Rubber            | 350202-302-05     | MO     |
| 10.00             | 5.00  | 6.500 | SM        | Rubber            | 350202-302-41     | MO     |
| 10.00             | 5.00  | 6.500 | Traction  | Rubber NM Cream   | 350202-313-42     | ML     |
| 10.00             | 5.00  | 6.500 | SM        | Rubber NM Grey    | 350202-318-41     | CS     |
| 10.00             | 5.00  | 6.500 | SM        | Rubber            | 350202-408-41     | CS     |
| 10.00             | 5.00  | 6.500 | Traction  | Rubber            | 350202-408-42     | CS     |
| 10.00             | 5.00  | 6.500 | SM        | FG                | 350202-421-41     | RR     |
| 10.00             | 5.00  | 6.500 | Traction  | FG                | 350202-421-42     | RR     |
| 10.00             | 6.00  | 6.250 | SM        | Rubber            | 350008-302-41     | MO     |
| 10.00             | 6.00  | 6.250 | SM        | Rubber NM Cream   | 350008-313-41     | ML     |
| 10.00             | 6.00  | 6.500 | Traction  | Rubber            | 350020-303-42     | ML     |
| 10.00             | 6.00  | 6.500 | Traction  | FG                | 350038-428-42     | ML     |
| 10.00             | 7.00  | 6.250 | SM        | Rubber            | 350041-302-41     | MO     |
| <b>10.50 O.D.</b> |       |       |           |                   |                   |        |
| 10.50             | 5.00  | 6.500 | SM        | Rubber            | 350009-302-41     | MO     |
| 10.50             | 5.00  | 6.500 | Traction  | Rubber            | 350009-302-42     | MO     |
| 10.50             | 5.00  | 6.500 | SM        | Rubber NM Cream   | 350009-312-41     | MO     |
| 10.50             | 5.00  | 6.500 | SM        | FG                | 350009-421-41     | RR     |
| <b>12.00 O.D.</b> |       |       |           |                   |                   |        |
| 12.00             | 4.50  | 8.000 | SM        | Rubber            | 350032-302-41     | MO     |
| 12.00             | 4.50  | 8.000 | Traction  | Rubber            | 350032-308-42     | MO     |
| 12.00             | 4.50  | 8.000 | SM        | Rubber NM Cream   | 350032-312-41     | MO     |
| 12.00             | 4.50  | 8.000 | SM        | Rubber            | 350032-408-41     | CS     |
| 12.00             | 4.50  | 8.000 | SM        | FG                | 350032-421-41     | RR     |
| 12.00             | 5.00  | 8.000 | SM        | Walnut            | 350053-429-41     | ML     |
| 12.00             | 5.50  | 8.000 | SM        | Rubber            | 350010-302-41     | MO     |
| 12.00             | 5.50  | 8.000 | Traction  | FG                | 350010-421-42     | RR     |
| 12.00             | 5.50  | 8.000 | SM        | Walnut            | 350010-429-41     | ML     |
| <b>13.50 O.D.</b> |       |       |           |                   |                   |        |
| 13.50             | 4.50  | 8.000 | SM        | Rubber            | 350011-302-41     | MO     |
| 13.50             | 4.50  | 8.000 | SM        | Rubber            | 350011-303-41     | ML     |
| 13.50             | 4.50  | 8.000 | SM        | Rubber NM Cream   | 350011-312-41     | MO     |
| 13.50             | 4.50  | 8.000 | SM        | FG                | 350034-421-41     | RR     |
| 13.50             | 4.50  | 8.000 | Traction  | FG                | 350034-421-42     | RR     |
| 13.50             | 4.50  | 8.000 | SM        | FG                | 350034-422-41     | SU     |

New part

# Rubber Tires by Size

Continued ▶

Note: Profile and manufacturer key on page 11.29.

13.50 O.D. Continued

| O.D.              | Width | I.D.   | Profile   | Compound          | Crown Part Number | Manuf. |
|-------------------|-------|--------|-----------|-------------------|-------------------|--------|
| 13.50             | 4.50  | 8.000  | SM        | FG NM White       | 350034-438-41     | ML     |
| 13.50             | 5.50  | 8.000  | Traction  | Rubber            | 074458-001        | MO     |
| 13.50             | 5.50  | 8.000  | SM        | Rubber            | 074458-002        | MO     |
| 13.50             | 5.50  | 8.000  | SM        | FG                | 074458-004        | RR     |
| 13.50             | 5.50  | 8.000  | Traction  | FG                | 074458-005        | RR     |
| 13.50             | 5.50  | 8.000  | Traction  | Rubber NM Cream   | 074458-007        | MO     |
| 13.50             | 5.50  | 8.000  | SM        | Rubber NM Cream   | 074458-008        | MO     |
| 13.50             | 5.50  | 8.000  | Traction  | FG                | 074458-011        | ML     |
| 13.50             | 5.50  | 8.000  | SM        | Rubber            | 074458-301-41     | CS     |
| 13.50             | 5.50  | 8.000  | Traction  | Rubber            | 074458-301-42     | CS     |
| 13.50             | 5.50  | 8.000  | SM        | Rubber            | 350031-201-41     | RR     |
| 13.50             | 5.50  | 8.000  | Traction  | Rubber            | 350031-201-42     | RR     |
| 13.50             | 5.50  | 8.000  | Traction  | Rubber NM Dk Grey | 350031-211-42     | RR     |
| 13.50             | 5.50  | 8.000  | SM        | Rubber            | 350031-302-41     | MO     |
| 13.50             | 5.50  | 8.000  | Traction  | Rubber            | 350031-302-42     | MO     |
| 13.50             | 5.50  | 8.000  | SM        | Rubber            | 350031-303-41     | ML ☀️  |
| 13.50             | 5.50  | 8.000  | Traction  | Rubber            | 350031-303-42     | ML ☀️  |
| 13.50             | 5.50  | 8.000  | SM        | Rubber            | 350031-309-41     | SU     |
| 13.50             | 5.50  | 8.000  | SM        | Rubber NM Grey    | 350031-316-41     | CS     |
| 13.50             | 5.50  | 8.000  | SM        | Rubber NM Cream   | 350031-313-41     | ML ☀️  |
| 13.50             | 5.50  | 8.000  | Traction  | Rubber NM Grey    | 350031-319-42     | SU     |
| 13.50             | 5.50  | 8.000  | SM        | Rubber            | 350031-402-41     | MO     |
| 13.50             | 5.50  | 8.000  | SM        | Rubber            | 350031-404-41     | CO     |
| 13.50             | 5.50  | 8.000  | SM        | Rubber            | 350031-408-41     | CS     |
| 13.50             | 5.50  | 8.000  | Traction  | Rubber            | 350031-408-42     | CS     |
| 13.50             | 5.50  | 8.000  | SM        | Rubber NM Cream   | 350031-414-41     | CO     |
| 13.50             | 5.50  | 8.000  | SM        | Rubber NM Grey    | 350031-418-41     | CS     |
| 13.50             | 5.50  | 8.000  | Traction  | Rubber NM Grey    | 350031-418-42     | CS     |
| 13.50             | 5.50  | 8.000  | Thin Sipe | FG                | 350031-421-04     | RR     |
| 13.50             | 5.50  | 8.000  | Traction  | FG                | 350031-421-42     | RR ☀️  |
| 13.50             | 5.50  | 8.000  | SM        | FG Severe Duty    | 350031-424-41     | ML     |
| 13.50             | 5.50  | 8.000  | SM        | Walnut            | 350031-427-41     | ML     |
| 13.50             | 5.50  | 8.000  | Traction  | Walnut            | 350031-427-42     | ML     |
| 13.50             | 5.50  | 8.000  | SM        | FG                | 350031-428-41     | ML     |
| 13.50             | 5.50  | 8.000  | SM        | FG NM Black       | 350031-431-41     | RR     |
| 13.50             | 5.50  | 8.000  | Traction  | FG NM Black       | 350031-431-42     | RR     |
| 13.50             | 5.50  | 8.000  | Traction  | Walnut NM White   | 350031-437-42     | ML     |
| 13.50             | 5.50  | 8.000  | SM        | Rubber            | 350031-450-41     | CS     |
| 13.50             | 5.50  | 8.000  | SM        | Rubber NM Grey    | 350031-460-41     | CS     |
| 13.50             | 6.50  | 8.000  | SM        | Rubber            | 350203-305-41     | CS     |
| 13.50             | 6.50  | 8.000  | SM        | FG                | 350203-421-41     | RR     |
| 13.50             | 6.50  | 8.000  | Traction  | FG                | 350203-421-42     | RR     |
| <b>14.00 O.D.</b> |       |        |           |                   |                   |        |
| 14.00             | 4.50  | 8.000  | SM        | Rubber            | 350012-201-41     | RR     |
| 14.00             | 4.50  | 8.000  | Traction  | Rubber            | 350012-201-42     | RR     |
| 14.00             | 4.50  | 8.000  | SM        | Rubber NM Dk Grey | 350012-211-41     | RR     |
| 14.00             | 4.50  | 8.000  | Traction  | Rubber NM Dk Grey | 350012-211-42     | RR     |
| 14.00             | 4.50  | 8.000  | SM        | Rubber            | 350012-302-41     | MO     |
| 14.00             | 4.50  | 8.000  | Traction  | Rubber            | 350012-302-42     | MO     |
| 14.00             | 4.50  | 8.000  | SM        | Rubber            | 350012-408-41     | CS     |
| 14.00             | 4.50  | 8.000  | SM        | Rubber NM Cream   | 350012-312-41     | MO     |
| 14.00             | 4.50  | 8.000  | Traction  | Rubber NM Cream   | 350012-312-42     | MO     |
| 14.00             | 4.50  | 8.000  | Traction  | Rubber            | 350012-408-42     | CS     |
| 14.00             | 4.50  | 8.000  | SM        | Rubber NM Cream   | 350012-414-41     | CO     |
| 14.00             | 4.50  | 8.000  | SM        | Rubber NM Grey    | 350012-418-41     | CS     |
| 14.00             | 4.50  | 8.000  | Traction  | Rubber NM Grey    | 350012-418-42     | CS     |
| 14.00             | 4.50  | 8.000  | SM        | FG                | 350012-421-41     | RR     |
| 14.00             | 4.50  | 8.000  | Traction  | FG                | 350012-421-42     | RR     |
| 14.00             | 4.50  | 8.000  | SM        | FG NM Black       | 350012-431-41     | RR     |
| 14.00             | 4.50  | 8.000  | Traction  | FG NM Black       | 350012-431-42     | RR     |
| 14.00             | 5.00  | 10.000 | SM        | Rubber            | 350045-408-41     | CS     |
| 14.00             | 5.00  | 10.000 | SM        | Rubber NM Grey    | 350045-418-41     | CS     |
| 14.00             | 5.00  | 10.000 | SM        | Rubber NM Cream   | 350045-312-41     | MO     |
| 14.00             | 5.00  | 10.000 | Traction  | Rubber NM Cream   | 350045-312-42     | MO     |
| <b>15.00 O.D.</b> |       |        |           |                   |                   |        |
| 15.00             | 4.00  | 11.250 | SM        | Rubber NM Cream   | 350044-312-41     | MO     |

| O.D.              | Width | I.D.   | Profile  | Compound          | Crown Part Number | Manuf. |
|-------------------|-------|--------|----------|-------------------|-------------------|--------|
| 15.00             | 4.00  | 11.250 | SM       | Rubber            | 350044-408-41     | CS     |
| 15.00             | 5.00  | 11.250 | SM       | Rubber            | 124319            | MO     |
| 15.00             | 5.00  | 11.250 | Traction | Rubber            | 124799            | MO     |
| 15.00             | 5.00  | 11.250 | SM       | Rubber NM Cream   | 124806            | MO     |
| 15.00             | 5.00  | 11.250 | Traction | Rubber NM Cream   | 124807            | MO     |
| 15.00             | 5.00  | 11.250 | SM       | Rubber            | 137031-301-41     | CS     |
| 15.00             | 5.00  | 11.250 | Traction | Rubber            | 137031-301-42     | CS     |
| 15.00             | 5.00  | 11.250 | SM       | Rubber NM Grey    | 137031-311-41     | CS     |
| 15.00             | 5.00  | 11.250 | Traction | Rubber NM Grey    | 137031-311-42     | CS     |
| 15.00             | 5.00  | 11.250 | SM       | Rubber            | 350033-201-41     | RR     |
| 15.00             | 5.00  | 11.250 | Traction | Rubber            | 350033-201-42     | RR     |
| 15.00             | 5.00  | 11.250 | SM       | Rubber NM Dk Grey | 350033-211-41     | RR     |
| 15.00             | 5.00  | 11.250 | Traction | Rubber NM Dk Grey | 350033-211-42     | RR     |
| 15.00             | 5.00  | 11.250 | SM       | Rubber            | 350033-303-41     | ML ☀️  |
| 15.00             | 5.00  | 11.250 | Traction | Rubber            | 350033-303-42     | ML ☀️  |
| 15.00             | 5.00  | 11.250 | SM       | Rubber NM Cream   | 350033-313-41     | ML ☀️  |
| 15.00             | 5.00  | 11.250 | SM       | Rubber            | 350033-404-41     | CO     |
| 15.00             | 5.00  | 11.250 | SM       | Rubber NM Cream   | 350033-408-41     | CS ☀️  |
| 15.00             | 5.00  | 11.250 | Traction | Rubber            | 350033-408-42     | CS     |
| 15.00             | 5.00  | 11.250 | SM       | Rubber NM Cream   | 350033-414-41     | CO     |
| 15.00             | 5.00  | 11.250 | SM       | Rubber NM Grey    | 350033-418-41     | CS     |
| 15.00             | 5.00  | 11.250 | Traction | Rubber NM Grey    | 350033-418-42     | CS     |
| 15.00             | 5.00  | 11.250 | SM       | FG                | 350033-421-41     | RR     |
| 15.00             | 5.00  | 11.250 | Traction | FG                | 350033-421-42     | RR     |
| 15.00             | 5.00  | 11.250 | SM       | Walnut            | 350033-429-41     | ML     |
| 15.00             | 5.00  | 11.250 | Traction | Walnut            | 350033-429-42     | ML     |
| 15.00             | 5.00  | 11.250 | SM       | Rubber            | 350033-450-41     | CS     |
| 15.00             | 5.00  | 11.250 | SM       | Rubber NM Grey    | 350033-460-41     | CS     |
| 15.00             | 6.00  | 11.250 | SM       | Rubber            | 350014-302-41     | MO     |
| 15.00             | 6.00  | 11.250 | SM       | Rubber            | 350052-201-41     | RR     |
| 15.00             | 6.00  | 11.250 | Traction | Rubber            | 350052-201-42     | RR     |
| 15.00             | 7.00  | 11.250 | SM       | Rubber            | 350028-201-41     | RR     |
| 15.00             | 7.00  | 11.250 | SM       | Rubber            | 350028-302-41     | MO     |
| <b>16.00 O.D.</b> |       |        |          |                   |                   |        |
| 16.00             | 5.00  | 10.500 | SM       | Rubber            | 350016-201-41     | RR     |
| 16.00             | 5.00  | 10.500 | Traction | Rubber            | 350016-201-42     | RR     |
| 16.00             | 5.00  | 10.500 | SM       | Rubber NM Dk Grey | 350016-211-41     | RR     |
| 16.00             | 5.00  | 10.500 | Traction | Rubber NM Dk Grey | 350016-211-42     | RR     |
| 16.00             | 5.00  | 10.500 | SM       | Rubber            | 350016-302-41     | MO     |
| 16.00             | 5.00  | 10.500 | Traction | Rubber            | 350016-302-42     | MO     |
| 16.00             | 5.00  | 10.500 | Traction | Rubber            | 350016-307-42     | MO     |
| 16.00             | 5.00  | 10.500 | SM       | Rubber NM Cream   | 350016-312-41     | MO     |
| 16.00             | 5.00  | 10.500 | Traction | Rubber NM Cream   | 350016-312-42     | MO     |
| 16.00             | 5.00  | 10.500 | SM       | Rubber            | 350016-404-41     | CO     |
| 16.00             | 5.00  | 10.500 | Traction | Rubber            | 350016-404-42     | CO     |
| 16.00             | 5.00  | 10.500 | SM       | Rubber            | 350016-408-41     | CS     |
| 16.00             | 5.00  | 10.500 | Traction | Rubber            | 350016-408-42     | CS     |
| 16.00             | 5.00  | 10.500 | SM       | Rubber NM Cream   | 350016-414-41     | CO     |
| 16.00             | 5.00  | 10.500 | Traction | Rubber NM Cream   | 350016-414-42     | CO     |
| 16.00             | 5.00  | 10.500 | SM       | Rubber NM Grey    | 350016-418-41     | CS     |
| 16.00             | 5.00  | 10.500 | Traction | Rubber NM Grey    | 350016-418-42     | CS     |
| 16.00             | 5.00  | 10.500 | SM       | FG                | 350016-421-41     | RR     |
| 16.00             | 5.00  | 10.500 | Traction | FG                | 350016-421-42     | RR     |
| 16.00             | 5.00  | 10.500 | SM       | FG NM Black       | 350016-431-41     | RR     |
| 16.00             | 5.00  | 10.500 | Traction | FG NM Black       | 350016-431-42     | RR     |
| 16.00             | 5.00  | 10.500 | SM       | Rubber            | 350016-450-41     | CS     |
| 16.00             | 5.00  | 10.500 | SM       | Rubber NM Grey    | 350016-460-41     | CS     |
| 16.00             | 6.00  | 10.500 | Traction | Rubber            | 103157-001        | MO     |
| 16.00             | 6.00  | 10.500 | Traction | Rubber NM Cream   | 103157-002        | MO     |
| 16.00             | 6.00  | 10.500 | SM       | Rubber NM Cream   | 103157-003        | MO     |
| 16.00             | 6.00  | 10.500 | SM       | Rubber            | 103157-004        | MO     |
| 16.00             | 6.00  | 10.500 | Traction | Rubber            | 129222-001        | MO     |
| 16.00             | 6.00  | 10.500 | Traction | Rubber NM Cream   | 129222-002        | MO     |
| 16.00             | 6.00  | 10.500 | SM       | Rubber NM Cream   | 129222-003        | MO     |
| 16.00             | 6.00  | 10.500 | SM       | Rubber            | 129222-004        | MO     |
| 16.00             | 6.00  | 10.500 | SM       | Rubber            | 136162-301-41     | CS     |
| 16.00             | 6.00  | 10.500 | Traction | Rubber            | 136162-301-42     | CS     |

☀️ New part

16.00 O.D. Continued ▶

# Rubber Tires by Size

Continued ▶

Note: Profile and manufacturer key on page 11.29.

16.00 O.D. Continued

| O.D.              | Width | I.D.   | Profile  | Compound          | Crown Part Number | Manuf. |
|-------------------|-------|--------|----------|-------------------|-------------------|--------|
| 16.00             | 6.00  | 10.500 | SM       | Rubber            | 136162-305-41     | CS     |
| 16.00             | 6.00  | 10.500 | Traction | Rubber            | 136162-305-42     | CS     |
| 16.00             | 6.00  | 10.500 | SM       | Rubber NM Grey    | 136162-311-41     | CS     |
| 16.00             | 6.00  | 10.500 | Traction | Rubber NM Grey    | 136162-311-42     | CS     |
| 16.00             | 6.00  | 10.500 | SM       | Rubber NM Grey    | 136162-315-41     | CS     |
| 16.00             | 6.00  | 10.500 | Traction | Rubber NM Grey    | 136162-315-42     | CS     |
| 16.00             | 6.00  | 10.500 | SM       | Rubber            | 350054-201-41     | RR     |
| 16.00             | 6.00  | 10.500 | Traction | Rubber            | 350054-201-42     | RR     |
| 16.00             | 6.00  | 10.500 | SM       | Rubber NM Dk Grey | 350054-211-41     | RR     |
| 16.00             | 6.00  | 10.500 | Traction | Rubber NM Dk Grey | 350054-211-42     | RR     |
| 16.00             | 6.00  | 10.500 | SM       | Rubber            | 350054-303-41     | ML     |
| 16.00             | 6.00  | 10.500 | Traction | Rubber            | 350054-303-42     | ML     |
| 16.00             | 6.00  | 10.500 | SM       | Rubber NM Cream   | 350054-313-41     | ML     |
| 16.00             | 6.00  | 10.500 | SM       | Rubber            | 350054-404-41     | CO     |
| 16.00             | 6.00  | 10.500 | Traction | Rubber            | 350054-404-42     | CO     |
| 16.00             | 6.00  | 10.500 | SM       | Rubber            | 350054-408-41     | CS     |
| 16.00             | 6.00  | 10.500 | Traction | Rubber            | 350054-408-42     | CS     |
| 16.00             | 6.00  | 10.500 | SM       | Rubber NM Cream   | 350054-414-41     | CO     |
| 16.00             | 6.00  | 10.500 | Traction | Rubber NM Cream   | 350054-414-42     | CO     |
| 16.00             | 6.00  | 10.500 | SM       | Rubber NM Grey    | 350054-418-41     | CS     |
| 16.00             | 6.00  | 10.500 | Traction | Rubber NM Grey    | 350054-418-42     | CS     |
| 16.00             | 6.00  | 10.500 | SM       | FG                | 350054-421-41     | RR     |
| 16.00             | 6.00  | 10.500 | Traction | FG                | 350054-421-42     | RR     |
| 16.00             | 6.00  | 10.500 | SM       | FG NM Black       | 350054-431-41     | RR     |
| 16.00             | 6.00  | 10.500 | Traction | FG NM Black       | 350054-431-42     | RR     |
| 16.00             | 6.00  | 10.500 | SM       | Rubber            | 350054-450-41     | CS     |
| 16.00             | 6.00  | 10.500 | SM       | Rubber NM Grey    | 350054-460-41     | CS     |
| 16.00             | 7.00  | 10.500 | Traction | Rubber            | 103535-001        | MO     |
| 16.00             | 7.00  | 10.500 | Traction | Rubber NM Cream   | 103535-002        | MO     |
| 16.00             | 7.00  | 10.500 | Traction | Rubber            | 129223-001        | MO     |
| 16.00             | 7.00  | 10.500 | Traction | Rubber NM Cream   | 129223-002        | MO     |
| 16.00             | 7.00  | 10.500 | SM       | Rubber NM Cream   | 129223-003        | MO     |
| 16.00             | 7.00  | 10.500 | SM       | Rubber            | 129223-004        | MO     |
| 16.00             | 7.00  | 10.500 | SM       | Rubber            | 135906-301-41     | CS     |
| 16.00             | 7.00  | 10.500 | Traction | Rubber            | 135906-301-42     | CS     |
| 16.00             | 7.00  | 10.500 | SM       | Rubber            | 135906-305-41     | CS     |
| 16.00             | 7.00  | 10.500 | Traction | Rubber            | 135906-305-42     | CS     |
| 16.00             | 7.00  | 10.500 | SM       | Rubber NM Grey    | 135906-311-41     | CS     |
| 16.00             | 7.00  | 10.500 | Traction | Rubber NM Grey    | 135906-311-42     | CS     |
| 16.00             | 7.00  | 10.500 | SM       | Rubber NM Grey    | 135906-315-41     | CS     |
| 16.00             | 7.00  | 10.500 | Traction | Rubber NM Grey    | 135906-315-42     | CS     |
| 16.00             | 7.00  | 10.500 | SM       | Rubber            | 350051-303-41     | ML     |
| 16.00             | 7.00  | 10.500 | Traction | Rubber            | 350051-303-42     | ML     |
| 16.00             | 7.00  | 10.500 | RS       | Rubber NM Cream   | 350051-312-03     | MO     |
| 16.00             | 7.00  | 10.500 | SM       | Rubber NM Cream   | 350051-313-41     | ML     |
| 16.00             | 7.00  | 10.500 | SM       | Rubber            | 350051-404-41     | CO     |
| 16.00             | 7.00  | 10.500 | Traction | Rubber            | 350051-408-42     | CS     |
| 16.00             | 7.00  | 10.500 | SM       | Rubber NM Cream   | 350051-414-41     | CO     |
| 16.00             | 7.00  | 10.500 | SM       | Rubber NM Grey    | 350051-418-41     | CO     |
| 16.00             | 7.00  | 10.500 | Traction | Rubber NM Grey    | 350051-418-42     | CO     |
| 16.00             | 7.00  | 10.500 | SM       | FG                | 350051-421-41     | RR     |
| 16.00             | 7.00  | 10.500 | Traction | FG                | 350051-421-42     | RR     |
| 16.00             | 7.00  | 10.500 | SM       | Walnut            | 350051-429-41     | ML     |
| 16.00             | 7.00  | 10.500 | Traction | Walnut            | 350051-429-42     | ML     |
| 16.00             | 7.00  | 10.500 | SM       | Walnut NM White   | 350051-439-41     | ML     |
| 16.00             | 7.00  | 10.500 | SM       | Rubber            | 350051-450-41     | CS     |
| 16.00             | 7.00  | 10.500 | SM       | Rubber NM Grey    | 350051-460-41     | CS     |
| <b>16.25 O.D.</b> |       |        |          |                   |                   |        |
| 16.25             | 5.00  | 11.250 | SM       | Rubber            | 350017-302-41     | MO     |
| 16.25             | 5.00  | 11.250 | Traction | Rubber            | 350017-302-42     | MO     |
| 16.25             | 5.00  | 11.250 | SM       | Rubber            | 350017-408-41     | CS     |
| 16.25             | 5.00  | 11.250 | SM       | Rubber NM Cream   | 350017-312-41     | MO     |
| 16.25             | 5.00  | 11.250 | Traction | Rubber NM Cream   | 350017-312-42     | MO     |
| 16.25             | 5.00  | 11.250 | Traction | Rubber            | 350017-408-42     | CS     |
| 16.25             | 5.00  | 11.250 | SM       | Rubber NM Grey    | 350017-418-41     | CS     |
| 16.25             | 5.00  | 11.250 | Traction | Rubber NM Grey    | 350017-418-42     | CS     |
| 16.25             | 5.00  | 11.250 | SM       | FG                | 350017-421-41     | RR     |
| 16.25             | 5.00  | 11.250 | Traction | FG                | 350017-421-42     | RR     |

| O.D.              | Width | I.D.   | Profile  | Compound          | Crown Part Number | Manuf. |
|-------------------|-------|--------|----------|-------------------|-------------------|--------|
| 16.25             | 6.00  | 11.250 | SM       | Rubber            | 350018-201-41     | RR     |
| 16.25             | 6.00  | 11.250 | Traction | Rubber            | 350018-201-42     | RR     |
| 16.25             | 6.00  | 11.250 | SM       | Rubber NM Dk Grey | 350018-211-41     | RR     |
| 16.25             | 6.00  | 11.250 | Traction | Rubber NM Dk Grey | 350018-211-42     | RR     |
| 16.25             | 6.00  | 11.250 | SM       | Rubber            | 350018-302-41     | MO     |
| 16.25             | 6.00  | 11.250 | Traction | Rubber            | 350018-302-42     | MO     |
| 16.25             | 6.00  | 11.250 | SM       | Rubber            | 350018-408-41     | CS     |
| 16.25             | 6.00  | 11.250 | SM       | Rubber NM Cream   | 350018-312-41     | MO     |
| 16.25             | 6.00  | 11.250 | Traction | Rubber NM Cream   | 350018-312-42     | MO     |
| 16.25             | 6.00  | 11.250 | SM       | Rubber            | 350018-404-41     | CO     |
| 16.25             | 6.00  | 11.250 | Traction | Rubber            | 350018-408-42     | CS     |
| 16.25             | 6.00  | 11.250 | SM       | Rubber NM Cream   | 350018-414-41     | CO     |
| 16.25             | 6.00  | 11.250 | SM       | Rubber NM Grey    | 350018-418-41     | CS     |
| 16.25             | 6.00  | 11.250 | Traction | Rubber NM Grey    | 350018-418-42     | CS     |
| 16.25             | 6.00  | 11.250 | SM       | FG                | 350018-421-41     | RR     |
| 16.25             | 6.00  | 11.250 | Traction | FG                | 350018-421-42     | RR     |
| 16.25             | 7.00  | 11.250 | SM       | Rubber            | 350002-302-41     | MO     |
| 16.25             | 7.00  | 11.250 | Traction | Rubber            | 350002-302-42     | MO     |
| 16.25             | 7.00  | 11.250 | SM       | Rubber            | 350002-408-41     | CS     |
| 16.25             | 7.00  | 11.250 | SM       | Rubber NM Grey    | 350002-418-41     | CS     |
| 16.25             | 7.00  | 11.250 | SM       | Rubber NM Cream   | 350002-312-41     | MO     |
| 16.25             | 7.00  | 11.250 | Traction | Rubber NM Cream   | 350002-312-42     | MO     |
| <b>17.00 O.D.</b> |       |        |          |                   |                   |        |
| 17.00             | 5.00  | 12.125 | SM       | Rubber            | 350019-201-41     | RR     |
| 17.00             | 5.00  | 12.125 | Traction | Rubber            | 350019-201-42     | RR     |
| 17.00             | 5.00  | 12.125 | SM       | Rubber            | 350019-302-41     | MO     |
| 17.00             | 5.00  | 12.125 | SM       | Rubber            | 350019-408-41     | CS     |
| <b>18.00 O.D.</b> |       |        |          |                   |                   |        |
| 18.00             | 5.00  | 12.125 | SM       | Rubber            | 350021-302-41     | MO     |
| 18.00             | 5.00  | 12.125 | Traction | Rubber            | 350021-302-42     | MO     |
| 18.00             | 5.00  | 12.125 | SM       | Rubber NM Cream   | 350021-312-41     | MO     |
| 18.00             | 6.00  | 12.125 | SM       | Rubber            | 141058-301-41     | CS     |
| 18.00             | 6.00  | 12.125 | Traction | Rubber            | 141058-301-42     | CS     |
| 18.00             | 6.00  | 12.125 | SM       | Rubber NM Grey    | 141058-311-41     | CS     |
| 18.00             | 6.00  | 12.125 | Traction | Rubber NM Grey    | 141058-311-42     | CS     |
| 18.00             | 6.00  | 12.125 | SM       | Rubber            | 350022-201-41     | RR     |
| 18.00             | 6.00  | 12.125 | Traction | Rubber            | 350022-201-42     | RR     |
| 18.00             | 6.00  | 12.125 | SM       | Rubber NM Dk Grey | 350022-211-41     | RR     |
| 18.00             | 6.00  | 12.125 | Traction | Rubber NM Dk Grey | 350022-211-42     | RR     |
| 18.00             | 6.00  | 12.125 | SM       | Rubber            | 350022-302-41     | MO     |
| 18.00             | 6.00  | 12.125 | Traction | Rubber            | 350022-302-42     | MO     |
| 18.00             | 6.00  | 12.125 | Traction | Rubber            | 350022-307-42     | MO     |
| 18.00             | 6.00  | 12.125 | SM       | Rubber NM Cream   | 350022-312-41     | MO     |
| 18.00             | 6.00  | 12.125 | Traction | Rubber NM Cream   | 350022-312-42     | MO     |
| 18.00             | 6.00  | 12.125 | Traction | Rubber NM Cream   | 350022-317-42     | MO     |
| 18.00             | 6.00  | 12.125 | Traction | Rubber            | 350022-404-41     | CO     |
| 18.00             | 6.00  | 12.125 | Traction | Rubber            | 350022-408-42     | CS     |
| 18.00             | 6.00  | 12.125 | SM       | Rubber NM Cream   | 350022-414-41     | CO     |
| 18.00             | 6.00  | 12.125 | SM       | Rubber NM Grey    | 350022-418-41     | CS     |
| 18.00             | 6.00  | 12.125 | Traction | Rubber NM Grey    | 350022-418-42     | CS     |
| 18.00             | 6.00  | 12.125 | SM       | FG                | 350022-421-41     | RR     |
| 18.00             | 6.00  | 12.125 | Traction | FG                | 350022-421-42     | RR     |
| 18.00             | 6.00  | 12.125 | SM       | FG NM Black       | 350022-431-41     | RR     |
| 18.00             | 6.00  | 12.125 | Traction | FG NM Black       | 350022-431-42     | RR     |
| 18.00             | 6.00  | 12.125 | SM       | FG NM White       | 350022-438-41     | ML     |
| 18.00             | 7.00  | 12.125 | SM       | Rubber            | 124685            | MO     |
| 18.00             | 7.00  | 12.125 | Traction | Rubber            | 124898            | MO     |
| 18.00             | 7.00  | 12.125 | SM       | Rubber NM Cream   | 124943            | MO     |
| 18.00             | 7.00  | 12.125 | Traction | Rubber NM Cream   | 124944            | MO     |
| 18.00             | 7.00  | 12.125 | SM       | Rubber            | 137033-301-41     | CS     |
| 18.00             | 7.00  | 12.125 | Traction | Rubber            | 137033-301-42     | CS     |
| 18.00             | 7.00  | 12.125 | SM       | Rubber            | 137033-305-41     | CS     |
| 18.00             | 7.00  | 12.125 | Traction | Rubber            | 137033-305-42     | CS     |
| 18.00             | 7.00  | 12.125 | SM       | Rubber NM Grey    | 137033-311-41     | CS     |
| 18.00             | 7.00  | 12.125 | Traction | Rubber NM Grey    | 137033-311-42     | CS     |
| 18.00             | 7.00  | 12.125 | SM       | Rubber NM Grey    | 137033-315-41     | CS     |
| 18.00             | 7.00  | 12.125 | Traction | Rubber NM Grey    | 137033-315-42     | CS     |
| 18.00             | 7.00  | 12.125 | SM       | Rubber            | 350023-201-41     | RR     |

WHEELS AND TIRES

New part

18.00 O.D. Continued ▶

# Rubber Tires by Size

Continued ▶

Note: Profile and manufacturer key on page 11.29.

18.00 O.D. Continued

| O.D.              | Width | I.D.   | Profile  | Compound          | Crown Part Number | Manuf. |
|-------------------|-------|--------|----------|-------------------|-------------------|--------|
| 18.00             | 7.00  | 12.125 | Traction | Rubber            | 350023-201-42     | RR     |
| 18.00             | 7.00  | 12.125 | SM       | Rubber NM Dk Grey | 350023-211-41     | RR     |
| 18.00             | 7.00  | 12.125 | Traction | Rubber NM Dk Grey | 350023-211-42     | RR     |
| 18.00             | 7.00  | 12.125 | SM       | Rubber NM Grey    | 350023-212-41     | MO     |
| 18.00             | 7.00  | 12.125 | SM       | Rubber            | 350023-303-41     | ML 🌞   |
| 18.00             | 7.00  | 12.125 | Traction | Rubber            | 350023-303-42     | ML 🌞   |
| 18.00             | 7.00  | 12.125 | SM       | Rubber NM Cream   | 350023-312-41     | MO     |
| 18.00             | 7.00  | 12.125 | SM       | Rubber NM Cream   | 350023-313-41     | ML 🌞   |
| 18.00             | 7.00  | 12.125 | SM       | Rubber            | 350023-404-41     | CO     |
| 18.00             | 7.00  | 12.125 | Traction | Rubber            | 350023-404-42     | CO     |
| 18.00             | 7.00  | 12.125 | SM       | Rubber            | 350023-408-41     | CS     |
| 18.00             | 7.00  | 12.125 | Traction | Rubber            | 350023-408-42     | CS     |
| 18.00             | 7.00  | 12.125 | SM       | Rubber NM Cream   | 350023-414-41     | CO     |
| 18.00             | 7.00  | 12.125 | Traction | Rubber NM Cream   | 350023-414-42     | CO     |
| 18.00             | 7.00  | 12.125 | SM       | Rubber NM Grey    | 350023-418-41     | CS     |
| 18.00             | 7.00  | 12.125 | Traction | Rubber NM Grey    | 350023-418-42     | CS     |
| 18.00             | 7.00  | 12.125 | SM       | FG                | 350023-421-41     | RR     |
| 18.00             | 7.00  | 12.125 | Traction | FG                | 350023-421-42     | RR     |
| 18.00             | 7.00  | 12.125 | SM       | Walnut            | 350023-429-41     | ML     |
| 18.00             | 7.00  | 12.125 | Traction | Walnut            | 350023-429-42     | ML     |
| 18.00             | 7.00  | 12.125 | Traction | FG NM Black       | 350023-431-42     | RR     |
| 18.00             | 7.00  | 12.125 | SM       | Rubber            | 350023-450-41     | CS     |
| 18.00             | 7.00  | 12.125 | SM       | Rubber NM Grey    | 350023-460-41     | CS     |
| 18.00             | 8.00  | 12.125 | SM       | Rubber            | 124686            | MO     |
| 18.00             | 8.00  | 12.125 | SM       | Rubber            | 124739            | MO     |
| 18.00             | 8.00  | 12.125 | Traction | Rubber            | 124899            | MO     |
| 18.00             | 8.00  | 12.125 | Traction | Rubber NM Cream   | 124942            | MO     |
| 18.00             | 8.00  | 12.125 | SM       | Rubber            | 137216-301-41     | CS     |
| 18.00             | 8.00  | 12.125 | Traction | Rubber            | 137216-301-42     | CS     |
| 18.00             | 8.00  | 12.125 | SM       | Rubber NM Grey    | 137216-311-41     | CS     |
| 18.00             | 8.00  | 12.125 | Traction | Rubber NM Grey    | 137216-311-42     | CS     |
| 18.00             | 8.00  | 12.125 | SM       | Rubber            | 350046-201-41     | RR     |
| 18.00             | 8.00  | 12.125 | Traction | Rubber            | 350046-201-42     | RR     |
| 18.00             | 8.00  | 12.125 | SM       | Rubber NM Dk Grey | 350046-211-41     | RR     |
| 18.00             | 8.00  | 12.125 | Traction | Rubber NM Dk Grey | 350046-211-42     | RR     |
| 18.00             | 8.00  | 12.125 | SM       | Rubber NM Cream   | 350046-312-41     | MO     |
| 18.00             | 8.00  | 12.125 | SM       | Rubber            | 350046-404-41     | CO     |
| 18.00             | 8.00  | 12.125 | Traction | Rubber            | 350046-408-42     | CS     |
| 18.00             | 8.00  | 12.125 | SM       | FG                | 350046-421-41     | RR     |
| 18.00             | 8.00  | 12.125 | Traction | FG                | 350046-421-42     | RR     |
| 18.00             | 8.00  | 12.125 | Traction | Wire              | 350046-423-42     | ML     |
| 18.00             | 8.00  | 12.125 | SM       | Walnut            | 350046-427-41     | ML     |
| 18.00             | 8.00  | 12.125 | Traction | Walnut            | 350046-427-42     | ML     |
| 18.00             | 8.00  | 12.125 | SM       | Rubber            | 350046-450-41     | CS     |
| 18.00             | 8.00  | 12.125 | SM       | Rubber NM Grey    | 350046-460-41     | CS     |
| 18.00             | 9.00  | 12.125 | SM       | Rubber            | 350024-302-41     | MO     |
| 18.00             | 9.00  | 12.125 | Traction | Rubber            | 350024-302-42     | MO     |
| 18.00             | 9.00  | 12.125 | SM       | Rubber NM Cream   | 350024-312-41     | MO     |
| 18.00             | 9.00  | 12.125 | Traction | Rubber NM Cream   | 350024-312-42     | MO     |
| 18.00             | 9.00  | 12.125 | Traction | Rubber NM Grey    | 350024-418-42     | CS     |
| <b>20.00 O.D.</b> |       |        |          |                   |                   |        |
| 20.00             | 8.00  | 16.000 | SM       | Rubber            | 350025-408-41     | CS     |
| <b>21.00 O.D.</b> |       |        |          |                   |                   |        |
| 21.00             | 6.00  | 15.000 | SM       | Rubber            | 350027-302-41     | MO     |
| 21.00             | 6.00  | 15.000 | Traction | Rubber            | 350027-302-42     | MO     |
| 21.00             | 7.00  | 15.000 | Traction | Rubber            | 103151-001        | MO     |
| 21.00             | 7.00  | 15.000 | Traction | Rubber NM Cream   | 103151-002        | MO     |
| 21.00             | 7.00  | 15.000 | SM       | Rubber NM Cream   | 103151-003        | MO     |
| 21.00             | 7.00  | 15.000 | SM       | Rubber            | 103151-004        | MO     |
| 21.00             | 7.00  | 15.000 | Traction | Rubber            | 129219-001        | MO     |
| 21.00             | 7.00  | 15.000 | Traction | Rubber NM Cream   | 129219-002        | MO     |
| 21.00             | 7.00  | 15.000 | SM       | Rubber NM Cream   | 129219-003        | MO     |
| 21.00             | 7.00  | 15.000 | SM       | Rubber            | 129219-004        | MO     |
| 21.00             | 7.00  | 15.000 | SM       | Rubber            | 136019-301-41     | CS     |
| 21.00             | 7.00  | 15.000 | Traction | Rubber            | 136019-301-42     | CS     |
| 21.00             | 7.00  | 15.000 | SM       | Rubber            | 136019-305-41     | CS     |
| 21.00             | 7.00  | 15.000 | Traction | Rubber            | 136019-305-42     | CS     |
| 21.00             | 7.00  | 15.000 | SM       | Rubber NM Grey    | 136019-311-41     | CS     |

| O.D.  | Width | I.D.   | Profile  | Compound          | Crown Part Number | Manuf. |
|-------|-------|--------|----------|-------------------|-------------------|--------|
| 21.00 | 7.00  | 15.000 | Traction | Rubber NM Grey    | 136019-311-42     | CS     |
| 21.00 | 7.00  | 15.000 | SM       | Rubber NM Grey    | 136019-315-41     | CS     |
| 21.00 | 7.00  | 15.000 | Traction | Rubber NM Grey    | 136019-315-42     | CS     |
| 21.00 | 7.00  | 15.000 | SM       | Rubber            | 350047-201-41     | RR     |
| 21.00 | 7.00  | 15.000 | Traction | Rubber            | 350047-201-42     | RR     |
| 21.00 | 7.00  | 15.000 | SM       | Rubber NM Dk Grey | 350047-211-41     | RR     |
| 21.00 | 7.00  | 15.000 | Traction | Rubber NM Dk Grey | 350047-211-42     | RR     |
| 21.00 | 7.00  | 15.000 | SM       | Rubber            | 350047-303-41     | ML 🌞   |
| 21.00 | 7.00  | 15.000 | Traction | Rubber            | 350047-303-42     | ML 🌞   |
| 21.00 | 7.00  | 15.000 | SM       | Rubber NM Cream   | 350047-313-41     | ML 🌞   |
| 21.00 | 7.00  | 15.000 | SM       | Rubber            | 350047-404-41     | CO     |
| 21.00 | 7.00  | 15.000 | Traction | Rubber            | 350047-404-42     | CO     |
| 21.00 | 7.00  | 15.000 | SM       | Rubber            | 350047-408-41     | CS     |
| 21.00 | 7.00  | 15.000 | Traction | Rubber            | 350047-408-42     | CS     |
| 21.00 | 7.00  | 15.000 | SM       | Rubber NM Cream   | 350047-414-41     | CO     |
| 21.00 | 7.00  | 15.000 | Traction | Rubber NM Cream   | 350047-414-42     | CO     |
| 21.00 | 7.00  | 15.000 | SM       | Rubber NM Grey    | 350047-418-41     | CS     |
| 21.00 | 7.00  | 15.000 | Traction | Rubber NM Grey    | 350047-418-42     | CS     |
| 21.00 | 7.00  | 15.000 | SM       | FG                | 350047-421-41     | RR     |
| 21.00 | 7.00  | 15.000 | Traction | FG                | 350047-421-42     | RR     |
| 21.00 | 7.00  | 15.000 | SM       | FG NM Black       | 350047-431-41     | RR     |
| 21.00 | 7.00  | 15.000 | Traction | FG NM Black       | 350047-431-42     | RR     |
| 21.00 | 7.00  | 15.000 | Traction | FG NM White       | 350047-438-43     | ML     |
| 21.00 | 7.00  | 15.000 | SM       | Rubber            | 350047-450-41     | CS     |
| 21.00 | 7.00  | 15.000 | SM       | Rubber NM Grey    | 350047-460-41     | CS     |
| 21.00 | 8.00  | 15.000 | Traction | Rubber            | 103152-001        | MO     |
| 21.00 | 8.00  | 15.000 | Traction | Rubber NM Cream   | 103152-002        | MO     |
| 21.00 | 8.00  | 15.000 | SM       | Rubber NM Cream   | 103152-003        | MO     |
| 21.00 | 8.00  | 15.000 | SM       | Rubber            | 103152-004        | MO     |
| 21.00 | 8.00  | 15.000 | Traction | Rubber            | 129220-001        | MO     |
| 21.00 | 8.00  | 15.000 | Traction | Rubber NM Cream   | 129220-002        | MO     |
| 21.00 | 8.00  | 15.000 | SM       | Rubber NM Cream   | 129220-003        | MO     |
| 21.00 | 8.00  | 15.000 | SM       | Rubber            | 129220-004        | MO     |
| 21.00 | 8.00  | 15.000 | SM       | Rubber            | 137210-301-41     | CS     |
| 21.00 | 8.00  | 15.000 | Traction | Rubber            | 137210-301-42     | CS     |
| 21.00 | 8.00  | 15.000 | SM       | Rubber            | 137210-305-41     | CS     |
| 21.00 | 8.00  | 15.000 | Traction | Rubber            | 137210-305-42     | CS     |
| 21.00 | 8.00  | 15.000 | SM       | Rubber NM Grey    | 137210-311-41     | CS     |
| 21.00 | 8.00  | 15.000 | Traction | Rubber NM Grey    | 137210-311-42     | CS     |
| 21.00 | 8.00  | 15.000 | SM       | Rubber NM Grey    | 137210-315-41     | CS     |
| 21.00 | 8.00  | 15.000 | Traction | Rubber NM Grey    | 137210-315-42     | CS     |
| 21.00 | 8.00  | 15.000 | SM       | Rubber            | 350048-201-41     | RR     |
| 21.00 | 8.00  | 15.000 | Traction | Rubber            | 350048-201-42     | RR     |
| 21.00 | 8.00  | 15.000 | SM       | Rubber NM Dk Grey | 350048-211-41     | RR     |
| 21.00 | 8.00  | 15.000 | Traction | Rubber NM Dk Grey | 350048-211-42     | RR     |
| 21.00 | 8.00  | 15.000 | SM       | Rubber            | 350048-303-41     | ML 🌞   |
| 21.00 | 8.00  | 15.000 | Traction | Rubber            | 350048-303-42     | ML 🌞   |
| 21.00 | 8.00  | 15.000 | SM       | Rubber NM Cream   | 350048-313-41     | ML 🌞   |
| 21.00 | 8.00  | 15.000 | SM       | Rubber            | 350048-404-41     | CO     |
| 21.00 | 8.00  | 15.000 | Traction | Rubber            | 350048-404-42     | CO     |
| 21.00 | 8.00  | 15.000 | Traction | Rubber            | 350048-408-42     | CS     |
| 21.00 | 8.00  | 15.000 | SM       | Rubber NM Cream   | 350048-414-41     | CO     |
| 21.00 | 8.00  | 15.000 | Traction | Rubber NM Cream   | 350048-414-42     | CO     |
| 21.00 | 8.00  | 15.000 | SM       | Rubber NM Grey    | 350048-418-41     | CS     |
| 21.00 | 8.00  | 15.000 | Traction | Rubber NM Grey    | 350048-418-42     | CS     |
| 21.00 | 8.00  | 15.000 | SM       | FG                | 350048-421-41     | RR     |
| 21.00 | 8.00  | 15.000 | Traction | FG                | 350048-421-42     | RR     |
| 21.00 | 8.00  | 15.000 | SM       | FG NM Black       | 350048-431-41     | RR     |
| 21.00 | 8.00  | 15.000 | SM       | FG NM White       | 350048-438-41     | ML     |
| 21.00 | 8.00  | 15.000 | Traction | FG NM White       | 350048-438-42     | ML     |
| 21.00 | 8.00  | 15.000 | SM       | Rubber            | 350048-450-41     | CS     |
| 21.00 | 8.00  | 15.000 | SM       | Rubber NM Grey    | 350048-460-41     | CS     |
| 21.00 | 9.00  | 15.000 | Traction | Rubber            | 103153-001        | MO     |
| 21.00 | 9.00  | 15.000 | Traction | Rubber NM Cream   | 103153-002        | MO     |
| 21.00 | 9.00  | 15.000 | SM       | Rubber NM Cream   | 103153-003        | MO     |
| 21.00 | 9.00  | 15.000 | SM       | Rubber            | 103153-004        | MO     |
| 21.00 | 9.00  | 15.000 | Traction | Rubber            | 129221-001        | MO     |
| 21.00 | 9.00  | 15.000 | Traction | Rubber NM Cream   | 129221-002        | MO     |

🌞 New part

21.00 O.D. Continued ▶

WHEELS AND TIRES

# Rubber Tires by Size

Note: Profile and manufacturer key on page 11.29.

21.00 O.D. Continued

| O.D.              | Width | I.D.   | Profile  | Compound          | Crown Part Number | Manuf. |
|-------------------|-------|--------|----------|-------------------|-------------------|--------|
| 21.00             | 9.00  | 15.000 | SM       | Rubber NM Cream   | 129221-003        | MO     |
| 21.00             | 9.00  | 15.000 | SM       | Rubber            | 129221-004        | MO     |
| 21.00             | 9.00  | 15.000 | SM       | Rubber            | 137211-301-41     | CS     |
| 21.00             | 9.00  | 15.000 | Traction | Rubber            | 137211-301-42     | CS     |
| 21.00             | 9.00  | 15.000 | SM       | Rubber NM Grey    | 137211-311-41     | CS     |
| 21.00             | 9.00  | 15.000 | Traction | Rubber NM Grey    | 137211-311-42     | CS     |
| 21.00             | 9.00  | 15.000 | Traction | Rubber            | 350205-201-42     | RR     |
| 21.00             | 9.00  | 15.000 | SM       | Rubber            | 350205-404-41     | CO     |
| 21.00             | 9.00  | 15.000 | Traction | Rubber            | 350205-404-42     | CO     |
| 21.00             | 9.00  | 15.000 | Traction | Rubber            | 350205-408-42     | CS     |
| 21.00             | 9.00  | 15.000 | SM       | Rubber NM Cream   | 350205-414-41     | CO     |
| 21.00             | 9.00  | 15.000 | Traction | Rubber NM Cream   | 350205-414-42     | CO     |
| 21.00             | 9.00  | 15.000 | SM       | Rubber NM Grey    | 350205-418-41     | CS     |
| 21.00             | 9.00  | 15.000 | SM       | Rubber            | 350205-450-41     | CS     |
| 21.00             | 9.00  | 15.000 | SM       | Rubber NM Grey    | 350205-460-41     | CS     |
| <b>22.00 O.D.</b> |       |        |          |                   |                   |        |
| 22.00             | 6.00  | 16.000 | SM       | Rubber            | 350065-408-41     | CS     |
| 22.00             | 7.00  | 16.000 | SM       | Rubber            | 350068-408-41     | CS     |
| 22.00             | 7.00  | 16.000 | SM       | Rubber NM Grey    | 350068-418-41     | CS     |
| 22.00             | 7.00  | 16.000 | Traction | Rubber NM Grey    | 350068-418-42     | CS     |
| 22.00             | 8.00  | 16.000 | SM       | Rubber            | 350039-302-41     | MO     |
| 22.00             | 8.00  | 16.000 | Traction | Rubber            | 350039-302-42     | MO     |
| 22.00             | 8.00  | 16.000 | SM       | Rubber NM Cream   | 350039-312-41     | MO     |
| 22.00             | 8.00  | 16.000 | Traction | Rubber NM Cream   | 350039-312-42     | MO     |
| 22.00             | 8.00  | 16.000 | Traction | Rubber            | 350039-408-42     | CS     |
| 22.00             | 8.00  | 16.000 | SM       | Rubber NM Grey    | 350039-418-41     | CS     |
| 22.00             | 8.00  | 16.000 | Traction | Rubber NM Grey    | 350039-418-42     | CS     |
| 22.00             | 8.00  | 16.000 | SM       | FG                | 350039-421-41     | RR     |
| 22.00             | 8.00  | 16.000 | Traction | FG                | 350039-421-42     | RR     |
| 22.00             | 9.00  | 16.000 | SM       | Rubber            | 350029-201-41     | RR     |
| 22.00             | 9.00  | 16.000 | Traction | Rubber            | 350029-201-42     | RR     |
| 22.00             | 9.00  | 16.000 | SM       | Rubber NM Dk Grey | 350029-211-41     | RR     |
| 22.00             | 9.00  | 16.000 | Traction | Rubber NM Dk Grey | 350029-211-42     | RR     |
| 22.00             | 9.00  | 16.000 | SM       | Rubber            | 350029-302-41     | MO     |
| 22.00             | 9.00  | 16.000 | Traction | Rubber            | 350029-302-42     | MO     |
| 22.00             | 9.00  | 16.000 | Traction | Rubber            | 350029-307-42     | MO     |

| O.D.              | Width | I.D.   | Profile  | Compound        | Crown Part Number | Manuf. |
|-------------------|-------|--------|----------|-----------------|-------------------|--------|
| 22.00             | 9.00  | 16.000 | SM       | Rubber NM Cream | 350029-312-41     | MO     |
| 22.00             | 9.00  | 16.000 | Traction | Rubber NM Cream | 350029-312-42     | MO     |
| 22.00             | 9.00  | 16.000 | Traction | Rubber NM Cream | 350029-317-42     | MO     |
| 22.00             | 9.00  | 16.000 | SM       | Rubber          | 350029-408-41     | CS     |
| 22.00             | 9.00  | 16.000 | Traction | Rubber          | 350029-408-42     | CS     |
| 22.00             | 9.00  | 16.000 | SM       | Rubber NM Grey  | 350029-418-41     | CS     |
| 22.00             | 9.00  | 16.000 | Traction | Rubber NM Grey  | 350029-418-42     | CS     |
| 22.00             | 9.00  | 16.000 | SM       | FG              | 350029-421-41     | RR     |
| 22.00             | 9.00  | 16.000 | Traction | FG              | 350029-421-42     | RR     |
| 22.00             | 10.00 | 16.000 | SM       | Rubber          | 350035-408-41     | CS     |
| 22.00             | 10.00 | 16.000 | Traction | Rubber          | 350035-408-42     | CS     |
| 22.00             | 12.00 | 16.000 | SM       | Rubber          | 350037-302-41     | MO     |
| 22.00             | 12.00 | 16.000 | Traction | Rubber          | 350037-302-42     | MO     |
| 22.00             | 12.00 | 16.000 | SM       | Rubber NM Cream | 350037-312-41     | MO     |
| 22.00             | 12.00 | 16.000 | Traction | Rubber NM Cream | 350037-312-42     | MO     |
| 22.00             | 12.00 | 16.000 | SM       | Rubber          | 350037-404-42     | CO     |
| 22.00             | 12.00 | 16.000 | SM       | Rubber          | 350037-408-41     | CS     |
| 22.00             | 12.00 | 16.000 | Traction | Rubber          | 350037-408-42     | CS     |
| 22.00             | 12.00 | 16.000 | SM       | Rubber NM Grey  | 350037-418-41     | CS     |
| 22.00             | 12.00 | 16.000 | Traction | Rubber NM Grey  | 350037-418-42     | CS     |
| 22.00             | 12.00 | 16.000 | SM       | Rubber          | 350037-450-41     | CS     |
| 22.00             | 12.00 | 16.000 | SM       | Rubber NM Grey  | 350037-460-41     | CS     |
| <b>28.00 O.D.</b> |       |        |          |                 |                   |        |
| 28.00             | 10.00 | 22.000 | SM       | Rubber          | 350069-408-41     | CS     |
| 28.00             | 12.00 | 22.000 | SM       | Rubber          | 350030-302-41     | MO     |
| 28.00             | 12.00 | 22.000 | Traction | Rubber          | 350030-302-42     | MO     |
| 28.00             | 12.00 | 22.000 | SM       | Rubber NM Cream | 350030-312-41     | MO     |
| 28.00             | 12.00 | 22.000 | Traction | Rubber NM Cream | 350030-312-42     | MO     |
| 28.00             | 12.00 | 22.000 | SM       | Rubber          | 350030-402-41     | MO     |
| 28.00             | 12.00 | 22.000 | SM       | Rubber          | 350030-408-41     | CS     |
| 28.00             | 12.00 | 22.000 | Traction | Rubber          | 350030-408-42     | CS     |
| 28.00             | 12.00 | 22.000 | SM       | Rubber NM Grey  | 350030-418-41     | CS     |
| 28.00             | 12.00 | 22.000 | Traction | Rubber NM Grey  | 350030-418-42     | CS     |
| 28.00             | 16.00 | 22.000 | SM       | Rubber          | 350070-408-41     | CS     |

WHEELS AND TIRES

Check out Crown's selection of aerosols. See Section 1.



# Wheel & Tire Cross References by Manufacturer

Continued ▶

| OE Number                  | Crown Number | Description                    |
|----------------------------|--------------|--------------------------------|
| <b>Allis Chalmers (AC)</b> |              |                                |
| 105                        | 310077       | Wheel 3.25x5.88x2.047x0.599    |
| 202                        | 310078       | Wheel 3.25x2.88x2.047x0.59     |
| 204                        | 310080       | Wheel 3x2x2.047x0.625          |
| 301                        | 073961       | Wheel 4x2.88x2.047x0.59        |
| 302                        | 310164       | Wheel 5x2.88x2.047x0.59        |
| 304                        | 310154       | Wheel 6x3.94x2.872x1.224       |
| 306                        | 310160       | Wheel 5x3.63x2.44x0.668        |
| 353                        | 071894       | Wheel 4x2.06x1.189             |
| 653                        | 310244       | Wheel 3.25x4.5x2.047x.594      |
| 981                        | 310102       | Wheel 5x3.62x2.834x0.76        |
| 983                        | 310077       | Wheel 3.25x5.88x2.047x0.599    |
| 986                        | 310154       | Wheel 6x3.94x2.872x1.224       |
| 987                        | 310078       | Wheel 3.25x2.88x2.047x0.59     |
| 989                        | 077086       | Wheel 3.25x5x2.047x0.59        |
| 9812                       | 310077       | Wheel 3.25x5.88x2.047x0.599    |
| 9824                       | 310080       | Wheel 3x2x2.047x0.625          |
| 9827                       | 310164       | Wheel 5x2.88x2.047x0.59        |
| 9828                       | 310101       | Wheel 3.38x2.63x1.979x1.242    |
| 9851                       | 310244       | Wheel 3.25x4.5x2.047x.594      |
| 9862                       | 310160       | Wheel 5x3.63x2.44x0.668        |
| 9870                       | 310164       | Wheel 5x2.88x2.047x0.59        |
| 605035                     | 310077       | Wheel 3.25x5.88x2.047x0.599    |
| 4814152                    | 073961       | Wheel 4x2.88x2.047x0.59        |
| 4814484                    | 310101       | Wheel 3.38x2.63x1.979x1.242    |
| 4816552                    | 073961       | Wheel 4x2.88x2.047x0.59        |
| 4826270                    | 310164       | Wheel 5x2.88x2.047x0.59        |
| 4826279                    | 310164       | Wheel 5x2.88x2.047x0.59        |
| 4854131                    | 081645       | Wheel Poly                     |
| 4865875                    | 310132       | Wheel 6x3x2.047x0.595          |
| 4876612                    | 310077       | Wheel 3.25x5.88x2.047x0.599    |
| 4878390                    | 310082       | Wheel 6x2.4x1.979x0.8800       |
| 4879331                    | 310087       | Wheel 7x2.86x2.047xNon Typical |
| 4900617                    | 310102       | Wheel 5x3.62x2.834x0.76        |
| 4910260                    | 073961       | Wheel 4x2.88x2.047x0.59        |
| 4930044                    | 310087       | Wheel 7x2.86x2.047xNon Typical |
| 4930101                    | 310164       | Wheel 5x2.88x2.047x0.59        |
| 4930836                    | 310102       | Wheel 5x3.62x2.834x0.76        |
| 4932096                    | 310077       | Wheel 3.25x5.88x2.047x0.599    |
| 4932226                    | 310077       | Wheel 3.25x5.88x2.047x0.599    |
| 4934289                    | 083179       | Wheel 4x2.50x2.047x0.59        |
| 4972095                    | 083179       | Wheel 4x2.50x2.047x0.59        |
| 8611635                    | 310078       | Wheel 3.25x2.88x2.047x0.59     |
| 8611657                    | 310077       | Wheel 3.25x5.88x2.047x0.599    |
| 8612234                    | 310077       | Wheel 3.25x5.88x2.047x0.599    |
| 8623144                    | 310155       | Wheel 7x2.5x2.326xNon Typical  |
| 8623929                    | 310101       | Wheel 3.38x2.63x1.979x1.242    |
| 8730186                    | 077086       | Wheel 3.25x5x2.047x0.59        |
| 8730459                    | 310085       | Wheel 3.25x6x2.047x0.585       |
| 8730461                    | 310147       | Wheel 3.25x6x2.047x1.187       |
| 8731313                    | 310155       | Wheel 7x2.5x2.326xNon Typical  |
| 8731340                    | 310102       | Wheel 5x3.62x2.834x0.76        |
| 8732658                    | 310154       | Wheel 6x3.94x2.872x1.224       |
| 8733670                    | 310227       | Wheel 7x2.75x1.98              |
| 8733671                    | 310227       | Wheel 7x2.75x1.98              |
| 8733981                    | 310227       | Wheel 7x2.75x1.98              |
| 49306145                   | 310160       | Wheel 5x3.63x2.44x0.668        |
| 74814152                   | 073961       | Wheel 4x2.88x2.047x0.59        |
| 74814484                   | 310077       | Wheel 3.25x5.88x2.047x0.599    |
| 74816552                   | 073961       | Wheel 4x2.88x2.047x0.59        |
| 74826270                   | 310087       | Wheel 7x2.86x2.047xNon Typical |
| 74826279                   | 310090       | Wheel 8x2x2.047x0.595          |
| 74850520                   | 310132       | Wheel 6x3x2.047x0.595          |
| 74854131                   | 310078       | Wheel 3.25x2.88x2.047x0.59     |
| 74865815                   | 310154       | Wheel 6x3.94x2.872x1.224       |
| 74865875                   | 310154       | Wheel 6x3.94x2.872x1.224       |
| 74876612                   | 310077       | Wheel 3.25x5.88x2.047x0.599    |
| 74878390                   | 073961       | Wheel 4x2.88x2.047x0.59        |
| 74879331                   | 310090       | Wheel 8x2x2.047x0.595          |

| OE Number         | Crown Number | Description                    |
|-------------------|--------------|--------------------------------|
| 74900617          | 310102       | Wheel 5x3.62x2.834x0.76        |
| 74930614          | 310087       | Wheel 7x2.86x2.047xNon Typical |
| 749306145         | 071894       | Wheel 4 Poly                   |
| 74930744          | 310164       | Wheel 5x2.88x2.047x0.59        |
| 74931496          | 310080       | Wheel 3x2x2.047x0.625          |
| 74932910          | 310235       | Wheel 4x2.88x2.44x0.672        |
| 74934289          | 083179       | Wheel 4x2.50x2.047x0.59        |
| 74972095          | 083179       | Wheel 4x2.50x2.047x0.59        |
| 78612234          | 310077       | Wheel 3.25x5.88x2.047x0.599    |
| 78623929          | 310101       | Wheel 3.38x2.63x1.979x1.242    |
| 78730461          | 310077       | Wheel 3.25x5.88x2.047x0.599    |
| 78731313          | 310164       | Wheel 5x2.88x2.047x0.59        |
| 78731340          | 310102       | Wheel 5x3.62x2.834x0.76        |
| 78731798          | 310087       | Wheel 7x2.86x2.047xNon Typical |
| 78734185          | 310244       | Wheel 3.25x4.5x2.047x.594      |
| S653              | 310244       | Wheel 3.25x4.5x2.047x.594      |
| S654              | 073961       | Wheel 4x2.88x2.047x0.59        |
| S976              | 310164       | Wheel 5x2.88x2.047x0.59        |
| S977              | 310160       | Wheel 5x3.63x2.44x0.668        |
| S979              | 310102       | Wheel 5x3.62x2.834x0.76        |
| S981              | 310102       | Wheel 5x3.62x2.834x0.76        |
| S983              | 310077       | Wheel 3.25x5.88x2.047x0.599    |
| S986              | 310155       | Wheel 7x2.5x2.326xNon Typical  |
| S987              | 310078       | Wheel 3.25x2.88x2.047x0.59     |
| S988              | 310087       | Wheel 7x2.86x2.047xNon Typical |
| S991              | 310080       | Wheel 3x2x2.047x0.625          |
| S992              | 310080       | Wheel 3x2x2.047x0.625          |
| S994              | 310101       | Wheel 3.38x2.63x1.979x1.242    |
| S995              | 071894       | Wheel 4 Poly                   |
| <b>Atlas (AT)</b> |              |                                |
| 9433              | 310189       | Wheel 3x3.5x1.85x0.56          |
| <b>Baker (BK)</b> |              |                                |
| 0009902353        | 807557       | Drive Tire Assembly ESR4500    |
| 1064596           | 807557       | Drive Tire Assembly ESR4500    |
| 114421            | 310142       | Wheel 4x2.88x2.44x0.75         |
| 115311            | 310133       | Wheel 5x2.88x2.44x0.775        |
| 138074            | 310094       | Wheel 4x2x1.575x0.575          |
| 138938            | 310133       | Wheel 5x2.88x2.44x0.775        |
| 139064            | 310146       | Wheel 3.25x6.38x2.047x0.812    |
| 139840            | 310146       | Wheel 3.25x6.38x2.047x0.812    |
| 146158            | 310146       | Wheel 3.25x6.38x2.047x0.812    |
| 529               | 310144       | Wheel 3.25x6x2.047x0.812       |
| 704152            | 310140       | Wheel 3.25x3.88x2.047x.812     |
| 704522            | 310141       | Wheel 3.25x3x2.047x0.812       |
| 705720            | 310094       | Wheel 4x2x1.575x0.575          |
| 707100            | 310142       | Wheel 4x2.88x2.44x0.75         |
| 708076            | 310146       | Wheel 3.25x6.38x2.047x0.812    |
| 708077            | 310142       | Wheel 4x2.88x2.44x0.75         |
| 708078            | 310133       | Wheel 5x2.88x2.44x0.775        |
| 708372            | 310140       | Wheel 3.25x3.88x2.047x.812     |
| 984075            | 310141       | Wheel 3.25x3x2.047x0.812       |
| 984840            | 310146       | Wheel 3.25x6.38x2.047x0.812    |
| 984841            | 310149       | Wheel 3.25x3x2.047x0.656       |
| 984842            | 310190       | Wheel 3.25x6.38x2.047x1.187    |
| 985604            | 310141       | Wheel 3.25x3x2.047x0.812       |
| 992628            | 310185       | Wheel 3.25x4.5x1.575x0.56      |
| 993470            | 073961       | Wheel 4x2.88x2.047x0.59        |
| 993472            | 073961       | Wheel 4x2.88x2.047x0.59        |
| 994070            | 310179       | Wheel 8x4x2.44x0.656           |
| 9902353           | 807557       | Drive Tire Assembly ESR4500    |
| 314X6             | 310144       | Wheel 3.25x6x2.047x0.812       |
| 8X4               | 310179       | Wheel 8x4x2.44x0.656           |
| AW-3-4            | 310179       | Wheel 8x4x2.44x0.656           |
| AW-4-1            | 310179       | Wheel 8x4x2.44x0.656           |
| BHP-014           | 310189       | Wheel 3x3.5x1.85x0.56          |
| BKAW-3-4          | 310179       | Wheel 8x4x2.44x0.656           |
| BKAW-4-1          | 310179       | Wheel 8x4x2.44x0.656           |
| BKW3-4G           | 073961       | Wheel 4x2.88x2.047x0.59        |
| L0009902353       | 807557       | Drive Tire Assembly ESR4500    |

**Note:** You need to add the compound part number to the wheel base number listed above. See compounds listed on page 11.03 for the dash number. Complete part number format is XXXXX-XXX.

Baker Continued ▶



# Wheel & Tire Cross References by Manufacturer

Continued ▶

Baker Continued

| OE Number           | Crown Number | Description                      |
|---------------------|--------------|----------------------------------|
| M0106SPEC           | 310147       | Wheel 3.25x6x2.047x1.187         |
| P30W                | 310185       | Wheel 3.25x4.5x1.575x0.56        |
| PAL-13              | 310145       | Wheel 3.25x6.25x2.047x0.812      |
| PAL-13-C            | 310141       | Wheel 3.25x3x2.047x0.812         |
| PAL-13-D            | 310141       | Wheel 3.25x3x2.047x0.812         |
| PAL-13GH            | 310140       | Wheel 3.25x3.88x2.047x.812       |
| PAL-13-GLD          | 310141       | Wheel 3.25x3x2.047x0.812         |
| PAL-13K             | 310140       | Wheel 3.25x3.88x2.047x.812       |
| PAL-13KG            | 310140       | Wheel 3.25x3.88x2.047x.812       |
| PAL-13M             | 310144       | Wheel 3.25x6x2.047x0.812         |
| PAL-43-A            | 310141       | Wheel 3.25x3x2.047x0.812         |
| W34                 | 073961       | Wheel 4x2.88x2.047x0.59          |
| W3-4                | 073961       | Wheel 4x2.88x2.047x0.59          |
| W34A                | 073961       | Wheel 4x2.88x2.047x0.59          |
| W3-4A               | 073961       | Wheel 4x2.88x2.047x0.59          |
| W3-4G               | 073961       | Wheel 4x2.88x2.047x0.59          |
| <b>Barrett (BR)</b> |              |                                  |
| 106                 | 310144       | Wheel 3.25x6x2.047x0.812         |
| 110                 | 310084       | Wheel 3.25x6x1.98x0.912          |
| 115                 | 310210       | Wheel 3.25x5.5x1.98x0.69         |
| 201                 | 310193       | Wheel 4x2.75x1.78x0.72           |
| 203                 | 310181       | Wheel 4x2.88x2.44x0.832          |
| 205                 | 310195       | Wheel 5x3x1.78x0.812             |
| 228                 | 310194       | Wheel 3.25x2.88x1.98xNon Typical |
| 234                 | 310193       | Wheel 4x2.75x1.78x0.72           |
| 238                 | 310192       | Wheel 7x4x2.44x0.838             |
| 239                 | 310191       | Wheel 6x3x2.44x0.838             |
| 246                 | 310210       | Wheel 3.25x5.5x1.98x0.69         |
| 248                 | 310084       | Wheel 3.25x6x1.98x0.912          |
| 254                 | 310195       | Wheel 5x3x1.78x0.812             |
| 255                 | 310195       | Wheel 5x3x1.78x0.812             |
| 257                 | 310183       | Wheel 4x2.75x2.44x0.843          |
| 262                 | 310171       | Wheel 6x3x1.781x0.81             |
| 268                 | 310196       | Wheel 6x3x1.938x0.969            |
| 305                 | 310191       | Wheel 6x3x2.44x0.838             |
| 308                 | 310133       | Wheel 5x2.88x2.44x0.775          |
| 308                 | 310143       | Wheel 5x2.88x2.44x0.75           |
| 315                 | 310192       | Wheel 7x4x2.44x0.838             |
| 336                 | 310171       | Wheel 6x3x1.781x0.81             |
| 9806                | 310149       | Wheel 3.25x3x2.047x0.656         |
| 9811                | 077086       | Wheel 3.25x5x2.047x0.59          |
| 9842                | 310181       | Wheel 4x2.88x2.44x0.832          |
| 9844                | 310235       | Wheel 4x2.88x2.44x0.672          |
| 9852                | 310133       | Wheel 5x2.88x2.44x0.775          |
| 9852                | 310143       | Wheel 5x2.88x2.44x0.75           |
| 9870                | 310155       | Wheel 7x2.5x2.326xNon Typical    |
| 116810              | 310071       | Tire Poly 18x8x12.125            |
| 116813              | 310064       | Tire Poly 16.25x5x11.25          |
| 116814              | 310068       | Tire Poly 18x6x12.125            |
| 116815              | 310060       | Tire Poly 16x5x10.5              |
| 127220              | 310061       | Tire Poly 16x6x10.5              |
| 127222              | 310073       | Tire Poly 21x7x15                |
| 137868              | 310003       | Tire Poly 8x4.5x4.5              |
| 139191              | 310202       | Tire Poly 10x5x6.5 w/Bevel       |
| 704662              | 310003       | Tire Poly 8x4.5x4.5              |
| 705357              | 310003       | Tire Poly 8x4.5x4.5              |
| 708394              | 310024       | Tire Poly 10.5x7x6.5             |
| 708396              | 310022       | Tire Poly 10.5x6x6.5             |
| 708397              | 075715       | Tire Poly 10x4x6.5               |
| 710330              | 310019       | Tire Poly 10.5x5x5               |
| 991012              | 107933       | Tire Poly 10x5x6.5 Contour       |
| 10761-058           | 310192       | Wheel 7x4x2.44x0.838             |
| 10761-29            | 310171       | Wheel 6x3x1.781x0.81             |
| 27462-008           | 310195       | Wheel 5x3x1.78x0.812             |
| 27462-025           | 310171       | Wheel 6x3x1.781x0.81             |
| 27845-11            | 310196       | Wheel 6x3x1.938x0.969            |
| 27845-21            | 310195       | Wheel 5x3x1.78x0.812             |
| 27845-40            | 310195       | Wheel 5x3x1.78x0.812             |
| 28-12               | 310191       | Wheel 6x3x2.44x0.838             |

| OE Number   | Crown Number | Description                      |
|-------------|--------------|----------------------------------|
| 28-152      | 310191       | Wheel 6x3x2.44x0.838             |
| 28-156      | 310192       | Wheel 7x4x2.44x0.838             |
| 28700-064   | 077086       | Wheel 3.25x5x2.047x0.59          |
| 28841-088   | 310181       | Wheel 4x2.88x2.44x0.832          |
| 28842-676   | 107933       | Tire Poly 10x5x6.5 Contour       |
| 28842-942   | 310155       | Wheel 7x2.5x2.326xNon Typical    |
| 304A        | 310196       | Wheel 6x3x1.938x0.969            |
| 39102-005   | 310171       | Wheel 6x3x1.781x0.81             |
| 39102-007   | 310171       | Wheel 6x3x1.781x0.81             |
| 40310-FS000 | 310178       | Wheel 3.25x5.91x2.047x1.18       |
| 40310-FS001 | 310147       | Wheel 3.25x6x2.047x1.187         |
| 40310-FS001 | 310242       | Wheel 3.25x5.98x2.047x1.368      |
| 40350-FS002 | 310242       | Wheel 3.25x5.98x2.047x1.368      |
| 43382-FS000 | 310126       | Wheel 5x2.5x1.85x0.675           |
| 9988-005    | 310193       | Wheel 4x2.75x1.78x0.72           |
| 9988-038    | 310144       | Wheel 3.25x6x2.047x0.812         |
| 9988-04     | 310084       | Wheel 3.25x6x1.98x0.912          |
| 9988-048    | 310084       | Wheel 3.25x6x1.98x0.912          |
| 9988-055    | 310144       | Wheel 3.25x6x2.047x0.812         |
| 9988-057    | 310210       | Wheel 3.25x5.5x1.98x0.69         |
| 9988-063    | 310194       | Wheel 3.25x2.88x1.98xNon Typical |
| 9988-064    | 310235       | Wheel 4x2.88x2.44x0.672          |
| 9988-065    | 310144       | Wheel 3.25x6x2.047x0.812         |
| 9988-066    | 310084       | Wheel 3.25x6x1.98x0.912          |
| 9988-068    | 310133       | Wheel 5x2.88x2.44x0.775          |
| 9988-068    | 310143       | Wheel 5x2.88x2.44x0.75           |
| 9988-57     | 310210       | Wheel 3.25x5.5x1.98x0.69         |
| 9988-60     | 310183       | Wheel 4x2.75x2.44x0.843          |
| 9988-63     | 310149       | Wheel 3.25x3x2.047x0.656         |
| A10761-002  | 310191       | Wheel 6x3x2.44x0.838             |
| A10761-006  | 310192       | Wheel 7x4x2.44x0.838             |
| A-10761-006 | 310192       | Wheel 7x4x2.44x0.838             |
| A10761-2    | 310191       | Wheel 6x3x2.44x0.838             |
| A-10761-2   | 310191       | Wheel 6x3x2.44x0.838             |
| A10761-49   | 310171       | Wheel 6x3x1.781x0.81             |
| A-10761-49  | 310171       | Wheel 6x3x1.781x0.81             |
| A10761-6    | 310192       | Wheel 7x4x2.44x0.838             |
| A-10761-6   | 310192       | Wheel 7x4x2.44x0.838             |
| A11151-2    | 310196       | Wheel 6x3x1.938x0.969            |
| A13076-008  | 107933       | Tire Poly 10x5x6.5 Contour       |
| A27462-008  | 310195       | Wheel 5x3x1.78x0.812             |
| A-27462-008 | 310195       | Wheel 5x3x1.78x0.812             |
| A27845-2    | 310196       | Wheel 6x3x1.938x0.969            |
| A27845-40   | 310229       | Wheel 5x3x3.25x1.78              |
| A30629-001  | 310202       | Tire Poly 10x5x6.5 w/Bevel       |
| A9988-005   | 310193       | Wheel 4x2.75x1.78x0.72           |
| A-9988-005  | 310193       | Wheel 4x2.75x1.78x0.72           |
| A-9988-048  | 310084       | Wheel 3.25x6x1.98x0.912          |
| A9988-057   | 310210       | Wheel 3.25x5.5x1.98x0.69         |
| A9988-30    | 310195       | Wheel 5x3x1.78x0.812             |
| A-9988-30   | 310229       | Wheel 5x3x3.25x1.78              |
| A9988-38    | 310144       | Wheel 3.25x6x2.047x0.812         |
| A-9988-38   | 310144       | Wheel 3.25x6x2.047x0.812         |
| A9988-48    | 310084       | Wheel 3.25x6x1.98x0.912          |
| A9988-5     | 310193       | Wheel 4x2.75x1.78x0.72           |
| A9988-54    | 310194       | Wheel 3.25x2.88x1.98xNon Typical |
| A-9988-54   | 310194       | Wheel 3.25x2.88x1.98xNon Typical |
| A-9988-57   | 310210       | Wheel 3.25x5.5x1.98x0.69         |
| AT-10761-29 | 310171       | Wheel 6x3x1.781x0.81             |
| AT-11151-2  | 310196       | Wheel 6x3x1.938x0.969            |
| AT-28-10    | 310196       | Wheel 6x3x1.938x0.969            |
| AT-28-12    | 310191       | Wheel 6x3x2.44x0.838             |
| AT-28-140   | 310196       | Wheel 6x3x1.938x0.969            |
| AT-28-152   | 310191       | Wheel 6x3x2.44x0.838             |
| B9988-54    | 310194       | Wheel 3.25x2.88x1.98xNon Typical |
| PM40265-00  | 107933       | Tire Poly 10x5x6.5 Contour       |
| S227        | 310149       | Wheel 3.25x3x2.047x0.656         |
| S228        | 310194       | Wheel 3.25x2.88x1.98xNon Typical |
| S230        | 310144       | Wheel 3.25x6x2.047x0.812         |

WHEELS AND TIRES

Barrett Continued ▶

**Note:** You need to add the compound part number to the wheel base number listed above. See compounds listed on page 11.03 for the dash number. Complete part number format is XXXXXX-XXX.

Barrett Continued

| OE Number           | Crown Number | Description                   |
|---------------------|--------------|-------------------------------|
| S234                | 310193       | Wheel 4x2.75x1.78x0.72        |
| S238                | 310192       | Wheel 7x4x2.44x0.838          |
| S239                | 310191       | Wheel 6x3x2.44x0.838          |
| S241                | 310196       | Wheel 6x3x1.938x0.969         |
| S246                | 310210       | Wheel 3.25x5.5x1.98x0.69      |
| S248                | 310084       | Wheel 3.25x6x1.98x0.912       |
| S250                | 310210       | Wheel 3.25x5.5x1.98x0.69      |
| S254                | 310195       | Wheel 5x3x1.78x0.812          |
| S255                | 310183       | Wheel 4x2.75x2.44x0.843       |
| S256                | 310084       | Wheel 3.25x6x1.98x0.912       |
| S258                | 310195       | Wheel 5x3x1.78x0.812          |
| S262                | 310171       | Wheel 6x3x1.78x0.81           |
| S263                | 310133       | Wheel 5x2.88x2.44x0.775       |
| S263                | 310143       | Wheel 5x2.88x2.44x0.75        |
| S268                | 310196       | Wheel 6x3x1.938x0.969         |
| S275                | 310195       | Wheel 5x3x1.78x0.812          |
| S282                | 310155       | Wheel 7x2.5x2.326xNon Typical |
| S284                | 310192       | Wheel 7x4x2.44x0.838          |
| S294                | 310181       | Wheel 4x2.88x2.44x0.832       |
| S295                | 310133       | Wheel 5x2.88x2.44x0.775       |
| S295                | 310143       | Wheel 5x2.88x2.44x0.75        |
| S304A               | 310196       | Wheel 6x3x1.938x0.969         |
| T0018-512PV         | 310067       | Tire Poly 18x5x12.125         |
| T0021-715SPU        | 310073       | Tire Poly 21x7x15             |
| T0186-12PUS         | 310068       | Tire Poly 18x6x12.125         |
| T0228-16TPU         | 310075       | Tire Poly 22x8x16             |
| T8-192              | 310191       | Wheel 6x3x2.44x0.838          |
| T-8-192             | 310191       | Wheel 6x3x2.44x0.838          |
| T8-197              | 310192       | Wheel 7x4x2.44x0.838          |
| T-8-28              | 310196       | Wheel 6x3x1.938x0.969         |
| <b>Big Joe (BJ)</b> |              |                               |
| 106                 | 310184       | Wheel 3.38x2.75x2.047x0.605   |
| 107                 | 310244       | Wheel 3.25x4.5x2.047x.594     |
| 108                 | 077084       | Wheel 3.25x3.25x2.047x0.59    |
| 119                 | 310101       | Wheel 3.38x2.63x1.979x1.242   |
| 202                 | 310098       | Wheel 4x2.75x1.938xThru       |
| 312                 | 310132       | Wheel 6x3x2.047x0.595         |
| 338                 | 310101       | Wheel 3.38x2.63x1.979x1.242   |
| 467                 | 310132       | Wheel 6x3x2.047x0.595         |
| 2335                | 310244       | Wheel 3.25x4.5x2.047x.594     |
| 2352                | 310098       | Wheel 4x2.75x1.938xThru       |
| 2353                | 310099       | Wheel 4x2.75x2.047x0.59       |
| 2360                | 310184       | Wheel 3.38x2.75x2.047x0.605   |
| 9133                | 077084       | Wheel 3.25x3.25x2.047x0.59    |
| 9145                | 081645       | Wheel Poly                    |
| 78217               | 310184       | Wheel 3.38x2.75x2.047x0.605   |
| 78228               | 310184       | Wheel 3.38x2.75x2.047x0.605   |
| 78242               | 310080       | Wheel 3x2x2.047x0.625         |
| 78255               | 077084       | Wheel 3.25x3.25x2.047x0.59    |
| 78257               | 310244       | Wheel 3.25x4.5x2.047x.594     |
| 78262               | 100462       | Wheel 3.25x6.5x2.047x1.44     |
| 78262               | 310000       | Wheel 3.25x6.5 Single Bearing |
| 78264               | 310101       | Wheel 3.38x2.63x1.979x1.242   |
| 78288               | 310184       | Wheel 3.38x2.75x2.047x0.605   |
| 78414               | 310099       | Wheel 4x2.75x2.047x0.59       |
| 78433               | 310099       | Wheel 4x2.75x2.047x0.59       |
| 79114               | 310020       | Tire Poly 10.5x5x6.5          |
| 79161               | 075715       | Tire Poly 10x4x6.5            |
| 79162               | 075715       | Tire Poly 10x4x6.5            |
| 79163               | 310020       | Tire Poly 10.5x5x6.5          |
| 79266               | 079266       | Tire Poly 13x5.5x8            |
| 79494               | 079494       | Tire Poly 13x4.5x8            |
| 501324              | 310132       | Wheel 6x3x2.047x0.595         |
| 501433              | 077084       | Wheel 3.25x3.25x2.047x0.59    |
| 501692              | 310244       | Wheel 3.25x4.5x2.047x.594     |
| 504146              | 310101       | Wheel 3.38x2.63x1.979x1.242   |
| 800032              | 081645       | Wheel Poly                    |
| 800059              | 310132       | Wheel 6x3x2.047x0.595         |
| 908000              | 310020       | Tire Poly 10.5x5x6.5          |

| OE Number                         | Crown Number | Description                   |
|-----------------------------------|--------------|-------------------------------|
| 911144                            | 310020       | Tire Poly 10.5x5x6.5          |
| 941182                            | 310208       | Tire Poly 9x5x5 Smooth Step   |
| S2352                             | 310098       | Wheel 4x2.75x1.938xThru       |
| S2353                             | 310099       | Wheel 4x2.75x2.047x0.59       |
| S2356                             | 077084       | Wheel 3.25x3.25x2.047x0.59    |
| S2358                             | 310132       | Wheel 6x3x2.047x0.595         |
| S2361                             | 081645       | Wheel Poly                    |
| S2364                             | 100462       | Wheel 3.25x6.5x2.047x1.44     |
| S2364                             | 310000       | Wheel 3.25x6.5 Single Bearing |
| S2365                             | 310244       | Wheel 3.25x4.5x2.047x.594     |
| S2373                             | 310184       | Wheel 3.38x2.75x2.047x0.605   |
| S2376                             | 310101       | Wheel 3.38x2.63x1.979x1.242   |
| S338                              | 310101       | Wheel 3.38x2.63x1.979x1.242   |
| <b>Blue Giant (BG)</b>            |              |                               |
| 101                               | 310083       | Wheel 3x3.75x1.625x0.435      |
| 103                               | 310085       | Wheel 3.25x6x2.047x0.585      |
| 301                               | 310090       | Wheel 8x2x2.047x0.595         |
| 930                               | 310083       | Wheel 3x3.75x1.625x0.435      |
| 931                               | 310090       | Wheel 8x2x2.047x0.595         |
| 9810                              | 310085       | Wheel 3.25x6x2.047x0.585      |
| 107193                            | 310097       | Wheel 8x2x1.998xThru          |
| 007-106-1                         | 310083       | Wheel 3x3.75x1.625x0.435      |
| 007-125-1                         | 310090       | Wheel 8x2x2.047x0.595         |
| 020-031                           | 310090       | Wheel 8x2x2.047x0.595         |
| 020-056-99                        | 310083       | Wheel 3x3.75x1.625x0.435      |
| 102-U                             | 310090       | Wheel 8x2x2.047x0.595         |
| 103-291                           | 310083       | Wheel 3x3.75x1.625x0.435      |
| 103-297                           | 310083       | Wheel 3x3.75x1.625x0.435      |
| 108-943                           | 310085       | Wheel 3.25x6x2.047x0.585      |
| 108-973-99                        | 310085       | Wheel 3.25x6x2.047x0.585      |
| 110-930                           | 310083       | Wheel 3x3.75x1.625x0.435      |
| 114-514                           | 310083       | Wheel 3x3.75x1.625x0.435      |
| 200-061                           | 310083       | Wheel 3x3.75x1.625x0.435      |
| 300-000                           | 310083       | Wheel 3x3.75x1.625x0.435      |
| 300-028                           | 310083       | Wheel 3x3.75x1.625x0.435      |
| BLR3-2120                         | 310083       | Wheel 3x3.75x1.625x0.435      |
| LR-783                            | 310090       | Wheel 8x2x2.047x0.595         |
| S925                              | 310090       | Wheel 8x2x2.047x0.595         |
| S930                              | 310083       | Wheel 3x3.75x1.625x0.435      |
| S931                              | 310090       | Wheel 8x2x2.047x0.595         |
| S935                              | 310085       | Wheel 3.25x6x2.047x0.585      |
| <b>BT (BT)</b>                    |              |                               |
| 23041-00                          | 077086       | Wheel 3.25x5x2.047x0.59       |
| 312636-001                        | 310316       | Wheel 3.25x4.48x2.047x0.582   |
| 40265-00                          | 107933       | Tire Poly 10x5x6.5 Contour    |
| 46106                             | 310288       | Wheel 5.5x2.38x2.047x0.590    |
| <b>Caterpillar/ Towmotor (CT)</b> |              |                               |
| 101                               | 310162       | Wheel 3.38x2.25x1.85x0.551    |
| 115                               | 310178       | Wheel 3.25x5.91x2.047x1.18    |
| 202                               | 310164       | Wheel 5x2.88x2.047x0.59       |
| 206                               | 310160       | Wheel 5x3.63x2.44x0.668       |
| 314                               | 310161       | Wheel 6x2.5x2.327x1.967       |
| 325                               | 310172       | Wheel 6x3.63x2.44x0.668       |
| 327                               | 310179       | Wheel 8x4x2.44x0.656          |
| 629                               | 154840       | Wheel 3.25x2x2.047x0.59       |
| 630                               | 310162       | Wheel 3.38x2.25x1.85x0.551    |
| 632                               | 310176       | Wheel 4x2x2.44xNon Typical    |
| 636                               | 310078       | Wheel 3.25x2.88x2.047x0.59    |
| 641                               | 073961       | Wheel 4x2.88x2.047x0.59       |
| 644                               | 310221       | Wheel 4x1.92x1.781x.84        |
| 645                               | 310158       | Wheel 4x3.62x2.047x0.59       |
| 653                               | 310164       | Wheel 5x2.88x2.047x0.59       |
| 654                               | 310160       | Wheel 5x3.63x2.44x0.668       |
| 663                               | 310161       | Wheel 6x2.5x2.327x1.967       |
| 673                               | 310172       | Wheel 6x3.63x2.44x0.668       |
| 684                               | 310179       | Wheel 8x4x2.44x0.656          |
| 699                               | 310177       | Wheel 6x3x2.047x0.67          |
| 700                               | 310178       | Wheel 3.25x5.91x2.047x1.18    |
| 7711                              | 310180       | Wheel 3.25x4.2x2.047x1.18     |

**Note:** You need to add the compound part number to the wheel base number listed above. See compounds listed on page 11.03 for the dash number. Complete part number format is XXXXXX-XXX.

Caterpillar/Towmotor Continued ▶

# Wheel & Tire Cross References by Manufacturer

Continued ▶

Caterpillar/Towmotor Continued

| OE Number | Crown Number | Description                |
|-----------|--------------|----------------------------|
| 9143      | 083179       | Wheel 4x2.50x2.047x0.59    |
| 9811      | 077086       | Wheel 3.25x5x2.047x0.59    |
| 12710     | 073961       | Wheel 4x2.88x2.047x0.59    |
| 12711     | 310158       | Wheel 4x3.62x2.047x0.59    |
| 12713     | 310164       | Wheel 5x2.88x2.047x0.59    |
| 12714     | 310160       | Wheel 5x3.63x2.44x0.668    |
| 12726     | 310179       | Wheel 8x4x2.44x0.656       |
| 12754     | 310172       | Wheel 6x3.63x2.44x0.668    |
| 17102     | 310221       | Wheel 4x1.92x1.781x.84     |
| 50432647  | 310467       | Caster Wheel Assembly      |
| 63009     | 310172       | Wheel 6x3.63x2.44x0.668    |
| 67018     | 083179       | Wheel 4x2.50x2.047x0.59    |
| 120737    | 120737       | Wheel Steer                |
| 289069    | 310178       | Wheel 3.25x5.91x2.047x1.18 |
| 971756    | 073961       | Wheel 4x2.88x2.047x0.59    |
| 971757    | 310160       | Wheel 5x3.63x2.44x0.668    |
| 971758    | 310161       | Wheel 6x2.5x2.327x1.967    |
| 971761    | 083179       | Wheel 4x2.50x2.047x0.59    |
| 971763    | 082021       | Wheel 6x2.75x3.149x0.83    |
| 971764    | 083587       | Wheel 5x4.12x3.149x0.98    |
| 971768    | 083586       | Wheel 5x2.88x3.149x0.98    |
| 971875    | 077086       | Wheel 3.25x5x2.047x0.59    |
| 971880    | 077086       | Wheel 3.25x5x2.047x0.59    |
| 971943    | 073961       | Wheel 4x2.88x2.047x0.59    |
| 971994    | 082443       | Wheel 2.50x2.06x1.187      |
| 971995    | 072718       | Wheel Assm Poly            |
| 971997    | 075999       | Wheel                      |
| 971999    | 083879       | Roller Load                |
| 972001    | 071665       | Wheel Polyurethane         |
| 972005    | 083879       | Roller Load                |
| 972007    | 100462       | Wheel 3.25x6.5x2.047x1.44  |
| 972008    | 077086       | Wheel 3.25x5x2.047x0.59    |
| 972010    | 083585       | Wheel 4x2.88x2.047x0.75    |
| 972012    | 081645       | Wheel Poly                 |
| 972015    | 073961       | Wheel 4x2.88x2.047x0.59    |
| 972016    | 081645       | Wheel Poly                 |
| 972019    | 071892       | Wheel 5 dia                |
| 972020    | 073602       | Wheel 5 Steel Assm         |
| 972021    | 083586       | Wheel 5x2.88x3.149x0.98    |
| 972025    | 082020       | Wheel 6x4.25x3.149x0.83    |
| 972027    | 080915       | Wheel 8x3.75x3.15x0.83     |
| 972061    | 083879       | Roller Load                |
| 973588    | 100462       | Wheel 3.25x6.5x2.047x1.44  |
| 1009233   | 310177       | Wheel 6x3x2.047x0.67       |
| 1009234   | 310178       | Wheel 3.25x5.91x2.047x1.18 |
| 1009298   | 310221       | Wheel 4x1.92x1.781x.84     |
| 1009309   | 310221       | Wheel 4x1.92x1.781x.84     |
| 1029601   | 310177       | Wheel 6x3x2.047x0.67       |
| 1029602   | 310178       | Wheel 3.25x5.91x2.047x1.18 |
| 1029606   | 310177       | Wheel 6x3x2.047x0.67       |
| 1029607   | 310178       | Wheel 3.25x5.91x2.047x1.18 |
| 1029608   | 310177       | Wheel 6x3x2.047x0.67       |
| 1036603   | 310172       | Wheel 6x3.63x2.44x0.668    |
| 1049809   | 073961       | Wheel 4x2.88x2.047x0.59    |
| 1049911   | 310158       | Wheel 4x3.62x2.047x0.59    |
| 1050132   | 310164       | Wheel 5x2.88x2.047x0.59    |
| 1050137   | 310160       | Wheel 5x3.63x2.44x0.668    |
| 1050142   | 310179       | Wheel 8x4x2.44x0.656       |
| 1050234   | 310179       | Wheel 8x4x2.44x0.656       |
| 1050236   | 310179       | Wheel 8x4x2.44x0.656       |
| 1050237   | 310160       | Wheel 5x3.63x2.44x0.668    |
| 1050280   | 310018       | Tire Poly 10.5x4.5x8       |
| 1051264   | 310179       | Wheel 8x4x2.44x0.656       |
| 1055548   | 310160       | Wheel 5x3.63x2.44x0.668    |
| 1055550   | 310158       | Wheel 4x3.62x2.047x0.59    |
| 1055551   | 073961       | Wheel 4x2.88x2.047x0.59    |
| 1055553   | 310164       | Wheel 5x2.88x2.047x0.59    |
| 1055574   | 310018       | Tire Poly 10.5x4.5x8       |
| 1075061   | 077086       | Wheel 3.25x5x2.047x0.59    |

| OE Number    | Crown Number | Description                      |
|--------------|--------------|----------------------------------|
| 1075062      | 077086       | Wheel 3.25x5x2.047x0.59          |
| 1075063      | 077086       | Wheel 3.25x5x2.047x0.59          |
| 1075064      | 077086       | Wheel 3.25x5x2.047x0.59          |
| 1086863      | 310180       | Wheel 3.25x4.2x2.047x1.18        |
| 1086864      | 310180       | Wheel 3.25x4.2x2.047x1.18        |
| 1086865      | 310180       | Wheel 3.25x4.2x2.047x1.18        |
| 1086866      | 310180       | Wheel 3.25x4.2x2.047x1.18        |
| 1092509      | 310176       | Wheel 4x2x2.44xNon Typical       |
| 1149188      | 310162       | Wheel 3.38x2.25x1.85x0.551       |
| 1154009      | 154840       | Wheel 3.25x2x2.047x0.59          |
| 1154011      | 154840       | Wheel 3.25x2x2.047x0.59          |
| 1154013      | 154840       | Wheel 3.25x2x2.047x0.59          |
| 1179201      | 310078       | Wheel 3.25x2.88x2.047x0.59       |
| 1179210      | 073961       | Wheel 4x2.88x2.047x0.59          |
| 1179213      | 310164       | Wheel 5x2.88x2.047x0.59          |
| 1201281      | 310078       | Wheel 3.25x2.88x2.047x0.59       |
| 1201764      | 154840       | Wheel 3.25x2x2.047x0.59          |
| 1201766      | 073961       | Wheel 4x2.88x2.047x0.59          |
| 1201767      | 310158       | Wheel 4x3.62x2.047x0.59          |
| 1201768      | 310158       | Wheel 4x3.62x2.047x0.59          |
| 1201769      | 310164       | Wheel 5x2.88x2.047x0.59          |
| 1201770      | 310160       | Wheel 5x3.63x2.44x0.668          |
| 1201771      | 310160       | Wheel 5x3.63x2.44x0.668          |
| 1201774      | 310078       | Wheel 3.25x2.88x2.047x0.59       |
| 1201776      | 310179       | Wheel 8x4x2.44x0.656             |
| 1201777      | 310179       | Wheel 8x4x2.44x0.656             |
| 1201778      | 310172       | Wheel 6x3.63x2.44x0.668          |
| 1201779      | 310172       | Wheel 6x3.63x2.44x0.668          |
| 1201785      | 310018       | Tire Poly 10.5x4.5x8             |
| 10289069     | 310178       | Wheel 3.25x5.91x2.047x1.18       |
| 50136157     | 370231       | Load Wheel Assembly              |
| 50179921     | 370231       | Load Wheel Assembly              |
| 51061889     | 310310       | Tire Poly 13.5x4.5x10.25         |
| 71305290     | 370231       | Load Wheel Assembly              |
| 00590-00027  | 310178       | Wheel 3.25x5.91x2.047x1.18       |
| 00590-41747  | 310225       | Wheel 6x3x1.9687                 |
| 116P         | 310078       | Wheel 3.25x2.88x2.047x0.59       |
| 2I2824       | 077086       | Wheel 3.25x5x2.047x0.59          |
| 2I5852       | 310131       | Wheel 8.5x2.66x2.754xNon Typical |
| 2I5854       | 310131       | Wheel 8.5x2.66x2.754xNon Typical |
| 2I5938       | 041269       | Wheel Poly                       |
| 310225-035   | 310225       | Wheel 6x3x1.9687                 |
| 312636-000   | 310316       | Wheel 3.25x4.48x2.047x0.582      |
| 325-P        | 310174       | Wheel 3.25x4x1.85x0.551          |
| 590-00013-71 | 310180       | Wheel 3.25x4.2x2.047x1.18        |
| 590-00506-71 | 310078       | Wheel 3.25x2.88x2.047x0.59       |
| 632-041      | 310168       | Wheel 5x1.12x2.047xNon Typical   |
| CTNA067018   | 083179       | Wheel 4x2.50x2.047x0.59          |
| CTS654X      | 310160       | Wheel 5x3.63x2.44x0.668          |
| S132         | 310180       | Wheel 3.25x4.2x2.047x1.18        |
| S2400        | 310178       | Wheel 3.25x5.91x2.047x1.18       |
| S2401        | 310162       | Wheel 3.38x2.25x1.85x0.551       |
| S2402        | 310164       | Wheel 5x2.88x2.047x0.59          |
| S2403        | 310160       | Wheel 5x3.63x2.44x0.668          |
| S2404        | 310161       | Wheel 6x2.5x2.327x1.967          |
| S626         | 310078       | Wheel 3.25x2.88x2.047x0.59       |
| S627         | 154840       | Wheel 3.25x2x2.047x0.59          |
| S629         | 310178       | Wheel 3.25x5.91x2.047x1.18       |
| S632         | 310176       | Wheel 4x2x2.44xNon Typical       |
| S636         | 077086       | Wheel 3.25x5x2.047x0.59          |
| S640         | 310221       | Wheel 4x1.92x1.781x.84           |
| S645         | 310158       | Wheel 4x3.62x2.047x0.59          |
| S653         | 310164       | Wheel 5x2.88x2.047x0.59          |
| S654         | 310160       | Wheel 5x3.63x2.44x0.668          |
| S654X        | 310160       | Wheel 5x3.63x2.44x0.668          |
| S673         | 310172       | Wheel 6x3.63x2.44x0.668          |
| S674         | 310172       | Wheel 6x3.63x2.44x0.668          |
| S675         | 310177       | Wheel 6x3x2.047x0.67             |
| S684         | 310179       | Wheel 8x4x2.44x0.656             |

WHEELS AND TIRES

**Note:** You need to add the compound part number to the wheel base number listed above. See compounds listed on page 11.03 for the dash number. Complete part number format is XXXXX-XXX.

Caterpillar/Towmotor Continued ▶

Caterpillar/Towmotor Continued

| OE Number         | Crown Number | Description                      |
|-------------------|--------------|----------------------------------|
| S700              | 310178       | Wheel 3.25x5.91x2.047x1.18       |
| S9811             | 077086       | Wheel 3.25x5x2.047x0.59          |
| S9812             | 077086       | Wheel 3.25x5x2.047x0.59          |
| S9813             | 077086       | Wheel 3.25x5x2.047x0.59          |
| S9814             | 077086       | Wheel 3.25x5x2.047x0.59          |
| S984              | 310078       | Wheel 3.25x2.88x2.047x0.59       |
| A0000-23185       | 310245       | Wheel 3.25x4.5x2.047x.710        |
| A0000-35291       | 310245       | Wheel 3.25x4.5x2.047x.710        |
| W2050-11106       | 370231       | Load Wheel Assembly              |
| W2050-12975       | 100462       | Wheel 3.25x6.5x2.047x1.44        |
| W2050-12884       | 310467       | Caster Wheel Assembly            |
| W5050-10126       | 310310       | Tire Poly 13.5x4.5x10.25         |
| <b>Clark (CL)</b> |              |                                  |
| 105               | 077086       | Wheel 3.25x5x2.047x0.59          |
| 109               | 310100       | Wheel 3.38x2.63x1.967x0.935      |
| 119               | 310101       | Wheel 3.38x2.63x1.979x1.242      |
| 123               | 310110       | Wheel 3.38x2.63x2.047x0.67       |
| 125               | 310110       | Wheel 3.38x2.63x2.047x0.67       |
| 130               | 310112       | Wheel 3.38x2.63x2.047x1.137      |
| 136               | 310118       | Wheel 3.25x2.63x2.046x1.1373     |
| 201               | 071894       | Wheel 4 Poly                     |
| 202               | 310103       | Wheel 4x2.63x2.44x0.77           |
| 203               | 310105       | Wheel 4x2.5x1.938x0.96           |
| 204               | 310114       | Wheel 4x2.5x2.047x0.76           |
| 211               | 310186       | Wheel 4x2.37x1.938x0.96          |
| 300               | 310113       | Wheel 3.35x5.74x2.047x1.452      |
| 301               | 310118       | Wheel 3.25x2.63x2.046x1.1373     |
| 303               | 310112       | Wheel 3.38x2.63x2.047x1.137      |
| 304               | 310114       | Wheel 4x2.5x2.047x0.76           |
| 306               | 310154       | Wheel 6x3.94x2.872x1.224         |
| 308               | 310109       | Wheel 6x4x2.834x1.17             |
| 309               | 310112       | Wheel 3.38x2.63x2.047x1.137      |
| 321               | 310104       | Wheel 5x2.62x2.834x0.77          |
| 325               | 310107       | Wheel 7x2.5x2.328xNon Typical    |
| 326               | 310106       | Wheel 4x3.62x2.44x0.77           |
| 332               | 310116       | Wheel 5x3.75x2.834x0.74          |
| 335               | 310100       | Wheel 3.38x2.63x1.967x0.935      |
| 338               | 310101       | Wheel 3.38x2.63x1.979x1.242      |
| 339               | 310110       | Wheel 3.38x2.63x2.047x0.67       |
| 341               | 310103       | Wheel 4x2.63x2.44x0.77           |
| 342               | 310105       | Wheel 4x2.5x1.938x0.96           |
| 343               | 310106       | Wheel 4x3.62x2.44x0.77           |
| 351               | 310104       | Wheel 5x2.62x2.834x0.77          |
| 353               | 310102       | Wheel 5x3.62x2.834x0.76          |
| 354               | 310116       | Wheel 5x3.75x2.834x0.74          |
| 362               | 310109       | Wheel 6x4x2.834x1.17             |
| 372               | 310107       | Wheel 7x2.5x2.328xNon Typical    |
| 395               | 310117       | Wheel 9x5x3.542x0.787 Black      |
| 502               | 310108       | Wheel 4x1.88x2.44x0.76           |
| 653               | 310164       | Wheel 5x2.88x2.047x0.59          |
| 824               | 310186       | Wheel 4x2.37x1.938x0.96          |
| 9102              | 071894       | Wheel 4 Poly                     |
| 9111              | 082021       | Wheel 6x2.75x3.149x0.83          |
| 9119              | 310131       | Wheel 8.5x2.66x2.754xNon Typical |
| 9136              | 100462       | Wheel 3.25x6.5x2.047x1.44        |
| 9139              | 083970       | Wheel 3.25x4.50x2.44x0.66        |
| 9151              | 083587       | Wheel 5x4.12x3.149x0.98          |
| 9152              | 083586       | Wheel 5x2.88x3.149x0.98          |
| 9330              | 310188       | Wheel 3.25x3.75x1.75xThru        |
| 9811              | 077086       | Wheel 3.25x5x2.047x0.59          |
| 9842              | 310181       | Wheel 4x2.88x2.44x0.832          |
| 9862              | 310154       | Wheel 6x3.94x2.872x1.224         |
| 182145            | 077086       | Wheel 3.25x5x2.047x0.59          |
| 301473            | 310109       | Wheel 6x4x2.834x1.17             |
| 310806            | 310109       | Wheel 6x4x2.834x1.17             |
| 311679            | 310109       | Wheel 6x4x2.834x1.17             |
| 314713            | 310100       | Wheel 3.38x2.63x1.967x0.935      |
| 315538            | 310100       | Wheel 3.38x2.63x1.967x0.935      |
| 315540            | 310100       | Wheel 3.38x2.63x1.967x0.935      |

| OE Number | Crown Number | Description                      |
|-----------|--------------|----------------------------------|
| 326915    | 310100       | Wheel 3.38x2.63x1.967x0.935      |
| 326917    | 310100       | Wheel 3.38x2.63x1.967x0.935      |
| 327229    | 310109       | Wheel 6x4x2.834x1.17             |
| 399153    | 310103       | Wheel 4x2.63x2.44x0.77           |
| 885906    | 310061       | Tire Poly 16x6x10.5              |
| 886191    | 310071       | Tire Poly 18x8x12.125            |
| 886192    | 310067       | Tire Poly 18x5x12.125            |
| 886310    | 107933       | Tire Poly 10x5x6.5 Contour       |
| 886342    | 310100       | Wheel 3.38x2.63x1.967x0.935      |
| 887050    | 077086       | Wheel 3.25x5x2.047x0.59          |
| 898577    | 310105       | Wheel 4x2.5x1.938x0.96           |
| 908684    | 310154       | Wheel 6x3.94x2.872x1.224         |
| 910970    | 310186       | Wheel 4x2.37x1.938x0.96          |
| 915157    | 083179       | Wheel 4x2.50x2.047x0.59          |
| 996691    | 310107       | Wheel 7x2.5x2.328xNon Typical    |
| 1612413   | 310104       | Wheel 5x2.62x2.834x0.77          |
| 1747963   | 310108       | Wheel 4x1.88x2.44x0.76           |
| 1780716   | 310101       | Wheel 3.38x2.63x1.979x1.242      |
| 1784625   | 310222       | Wheel 6x3.88x2.834x.735          |
| 1800127   | 310109       | Wheel 6x4x2.834x1.17             |
| 1800338   | 310103       | Wheel 4x2.63x2.44x0.77           |
| 1800344   | 073961       | Wheel 4x2.88x2.047x0.59          |
| 1800435   | 310104       | Wheel 5x2.62x2.834x0.77          |
| 1802523   | 310106       | Wheel 4x3.62x2.44x0.77           |
| 1802848   | 310039       | Tire Poly 13.5x5.5x8             |
| 1803654   | 083587       | Wheel 5x4.12x3.149x0.98          |
| 1803655   | 083586       | Wheel 5x2.88x3.149x0.98          |
| 1803656   | 082021       | Wheel 6x2.75x3.149x0.83          |
| 1803657   | 132359       | Wheel Caster                     |
| 1803657   | 310131       | Wheel 8.5x2.66x2.754xNon Typical |
| 1803659   | 100462       | Wheel 3.25x6.5x2.047x1.44        |
| 1803792   | 310164       | Wheel 5x2.88x2.047x0.59          |
| 1803794   | 083970       | Wheel 3.25x4.50x2.44x0.66        |
| 1803829   | 100462       | Wheel 3.25x6.5x2.047x1.44        |
| 1819046   | 310181       | Wheel 4x2.88x2.44x0.832          |
| 1820704   | 310003       | Tire Poly 8x4.5x4.5              |
| 1821946   | 077086       | Wheel 3.25x5x2.047x0.59          |
| 2309088   | 310116       | Wheel 5x3.75x2.834x0.74          |
| 2309954   | 107933       | Tire Poly 10x5x6.5 Contour       |
| 2324039   | 105089       | Tire Poly 10.5x4.5x8             |
| 2324040   | 310017       | Tire Poly 10.5x3.5x8             |
| 2324041   | 105089       | Tire Poly 10.5x4.5x8             |
| 2324106   | 310102       | Wheel 5x3.62x2.834x0.76          |
| 2326083   | 310072       | Tire Poly 18x9x12.125            |
| 2326659   | 310068       | Tire Poly 18x6x12.125            |
| 2334092   | 079266       | Tire Poly 13x5.5x8               |
| 2338041   | 310060       | Tire Poly 16x5x10.5              |
| 2381813   | 310101       | Wheel 3.38x2.63x1.979x1.242      |
| 2389996   | 310110       | Wheel 3.38x2.63x2.047x0.67       |
| 2742092   | 310110       | Wheel 3.38x2.63x2.047x0.67       |
| 2742092   | 310111       | Wheel 3.35x2.63x2.047x0.76       |
| 2750167   | 310144       | Wheel 3.25x6x2.047x0.812         |
| 2751505   | 310106       | Wheel 4x3.62x2.44x0.77           |
| 2758129   | 107933       | Tire Poly 10x5x6.5 Contour       |
| 2760613   | 310101       | Wheel 3.38x2.63x1.979x1.242      |
| 2775267   | 310117       | Wheel 9x5x3.542x0.787 Black      |
| 2777378   | 310114       | Wheel 4x2.5x2.047x0.76           |
| 2777940   | 310112       | Wheel 3.38x2.63x2.047x1.137      |
| 2778678   | 310113       | Wheel 3.35x5.74x2.047x1.452      |
| 2778705   | 107933       | Tire Poly 10x5x6.5 Contour       |
| 2779408   | 310112       | Wheel 3.38x2.63x2.047x1.137      |
| 2780830   | 310113       | Wheel 3.35x5.74x2.047x1.452      |
| 2788079   | 310116       | Wheel 5x3.75x2.834x0.74          |
| 2788081   | 310115       | Wheel 5x3x2.834x0.74             |
| 2792213   | 310117       | Wheel 9x5x3.542x0.787 Black      |
| 2793182   | 310117       | Wheel 9x5x3.542x0.787 Black      |
| 2793509   | 310039       | Tire Poly 13.5x5.5x8             |
| 2794001   | 310208       | Tire Poly 9x5x5 Smooth Step      |
| 2794307   | 079266       | Tire Poly 13x5.5x8               |

Clark Continued ▶

**Note:** You need to add the compound part number to the wheel base number listed above. See compounds listed on page 11.03 for the dash number. Complete part number format is XXXXX-XXX.

# Wheel & Tire Cross References by Manufacturer

Continued ▶

Clark Continued

| OE Number | Crown Number | Description                      |
|-----------|--------------|----------------------------------|
| 2795684   | 310116       | Wheel 5x3.75x2.834x0.74          |
| 2795685   | 310115       | Wheel 5x3x2.834x0.74             |
| 2800769   | 310138       | Wheel 3.25x4.71x2.047x0.825      |
| 2800770   | 310118       | Wheel 3.25x2.63x2.046x1.1373     |
| 7002324   | 082742       | Wheel Steel                      |
| 7003071   | 082274       | Wheel Assm                       |
| 7003097   | 044495       | Wheel Assm Poly                  |
| 7003580   | 082443       | Wheel 2.50x2.06x1.187            |
| 7003582   | 081645       | Wheel Poly                       |
| 106A      | 310144       | Wheel 3.25x6x2.047x0.812         |
| B26460    | 310154       | Wheel 6x3.94x2.872x1.224         |
| L000318   | 310118       | Wheel 3.25x2.63x2.046x1.1373     |
| L000319   | 310112       | Wheel 3.38x2.63x2.047x1.137      |
| L000322   | 310112       | Wheel 3.38x2.63x2.047x1.137      |
| L000328   | 310112       | Wheel 3.38x2.63x2.047x1.137      |
| L000333   | 310110       | Wheel 3.38x2.63x2.047x0.67       |
| L000335   | 310100       | Wheel 3.38x2.63x1.967x0.935      |
| L000338   | 310101       | Wheel 3.38x2.63x1.979x1.242      |
| L000339   | 310111       | Wheel 3.35x2.63x2.047x0.76       |
| L000341   | 310103       | Wheel 4x2.63x2.44x0.77           |
| L000342   | 310105       | Wheel 4x2.5x1.938x0.96           |
| L000343   | 310106       | Wheel 4x3.62x2.44x0.77           |
| L000344   | 310181       | Wheel 4x2.88x2.44x0.832          |
| L000345   | 077086       | Wheel 3.25x5x2.047x0.59          |
| L000346   | 310114       | Wheel 4x2.5x2.047x0.76           |
| L000351   | 310104       | Wheel 5x2.62x2.834x0.77          |
| L000353   | 310102       | Wheel 5x3.62x2.834x0.76          |
| L000359   | 310113       | Wheel 3.35x5.74x2.047x1.452      |
| L000362   | 310109       | Wheel 6x4x2.834x1.17             |
| L000366   | 310154       | Wheel 6x3.94x2.872x1.224         |
| L000372   | 310107       | Wheel 7x2.5x2.328xNon Typical    |
| L000376   | 310115       | Wheel 5x3x2.834x0.74             |
| L000377   | 310116       | Wheel 5x3.75x2.834x0.74          |
| L000393   | 310117       | Wheel 9x5x3.542x0.787 Black      |
| L000399   | 310112       | Wheel 3.38x2.63x2.047x1.137      |
| L000529   | 310144       | Wheel 3.25x6x2.047x0.812         |
| L000581   | 310179       | Wheel 8x4x2.44x0.656             |
| L000641   | 073961       | Wheel 4x2.88x2.047x0.59          |
| L000684   | 310179       | Wheel 8x4x2.44x0.656             |
| L000850   | 310093       | Wheel 3.25x6.5x1.98x1.177        |
| L002361   | 081645       | Wheel Poly                       |
| L009101   | 072718       | Wheel Assm Poly                  |
| L009103   | 073602       | Wheel 5 Steel Assm               |
| L009105   | 071892       | Wheel 5 dia                      |
| L009107   | 071665       | Wheel Polyurethane               |
| L009110   | 075999       | Wheel                            |
| L009111   | 082021       | Wheel 6x2.75x3.149x0.83          |
| L009112   | 082443       | Wheel 2.50x2.06x1.187            |
| L009113   | 083834       | Wheel                            |
| L009116   | 080915       | Wheel 8x3.75x3.15x0.83           |
| L009117   | 082020       | Wheel 6x4.25x3.149x0.83          |
| L009119   | 310131       | Wheel 8.5x2.66x2.754xNon Typical |
| L009130   | 311520       | Wheel 10x3 Caster                |
| L009132   | 083879       | Roller Load                      |
| L009135   | 077086       | Wheel 3.25x5x2.047x0.59          |
| L009136   | 100462       | Wheel 3.25x6.5x2.047x1.44        |
| L009138   | 083879       | Roller Load                      |
| L009138S  | 083879       | Roller Load                      |
| L009140   | 071665       | Wheel Polyurethane               |
| L009142   | 081645       | Wheel Poly                       |
| L009143   | 083179       | Wheel 4x2.50x2.047x0.59          |
| L009145   | 081645       | Wheel Poly                       |
| L009146   | 083585       | Wheel 4x2.88x2.047x0.75          |
| L009149   | 088628       | Wheel 4x4.12x2.047x0.75          |
| L009150   | 115032       | Wheel 5x2.88x2.44x0.83           |
| L009151   | 083587       | Wheel 5x4.12x3.149x0.98          |
| L009152   | 083586       | Wheel 5x2.88x3.149x0.98          |
| L009153   | 115033       | Wheel 5x4.12x2.44x0.83           |
| L009154   | 310131       | Wheel 8.5x2.66x2.754xNon Typical |
| L009157   | 115033       | Wheel 5x4.12x2.44x0.83           |

| OE Number          | Crown Number | Description                      |
|--------------------|--------------|----------------------------------|
| L009532            | 083879       | Roller Load                      |
| L010210            | 044507       | Roller Poly                      |
| L300628            | 310251       | Wheel 3.25x5.937x2.047x0.591     |
| L300982            | 081645       | Wheel Poly                       |
| L309105            | 071892       | Wheel 5 dia                      |
| L309107            | 071665       | Wheel Polyurethane               |
| L309111            | 082021       | Wheel 6x2.75x3.149x0.83          |
| L309116            | 080915       | Wheel 8x3.75x3.15x0.83           |
| L309117            | 082020       | Wheel 6x4.25x3.149x0.83          |
| L309130            | 311520       | Wheel 10x3 Caster                |
| L309140            | 071665       | Wheel Polyurethane               |
| L309146            | 083585       | Wheel 4x2.88x2.047x0.75          |
| L309149            | 088628       | Wheel 4x4.12x2.047x0.75          |
| L309153            | 115033       | Wheel 5x4.12x2.44x0.83           |
| L309154            | 310131       | Wheel 8.5x2.66x2.754xNon Typical |
| L309157            | 115033       | Wheel 5x4.12x2.44x0.83           |
| L502361            | 081645       | Wheel Poly                       |
| L509101            | 072718       | Wheel Assm Poly                  |
| L509109            | 083586       | Wheel 5x2.88x3.149x0.98          |
| L509110            | 075999       | Wheel                            |
| L509142            | 081645       | Wheel Poly                       |
| L509146            | 083585       | Wheel 4x2.88x2.047x0.75          |
| L509149            | 088628       | Wheel 4x4.12x2.047x0.75          |
| L509150            | 115032       | Wheel 5x2.88x2.44x0.83           |
| L509152            | 083586       | Wheel 5x2.88x3.149x0.98          |
| L509817            | 083179       | Wheel 4x2.50x2.047x0.59          |
| L510210            | 044507       | Roller Poly                      |
| R0101              | 310188       | Wheel 3.25x3.75x1.75xThru        |
| S303               | 310112       | Wheel 3.38x2.63x2.047x1.137      |
| S312               | 310188       | Wheel 3.25x3.75x1.75xThru        |
| S317               | 310186       | Wheel 4x2.37x1.938x0.96          |
| S318               | 310118       | Wheel 3.25x2.63x2.046x1.1373     |
| S319               | 310118       | Wheel 3.25x2.63x2.046x1.1373     |
| S322               | 310112       | Wheel 3.38x2.63x2.047x1.137      |
| S328               | 310112       | Wheel 3.38x2.63x2.047x1.137      |
| S333               | 310110       | Wheel 3.38x2.63x2.047x0.67       |
| S335               | 310100       | Wheel 3.38x2.63x1.967x0.935      |
| S338               | 310101       | Wheel 3.38x2.63x1.979x1.242      |
| S339               | 310110       | Wheel 3.38x2.63x2.047x0.67       |
| S339               | 310111       | Wheel 3.35x2.63x2.047x0.76       |
| S341               | 310103       | Wheel 4x2.63x2.44x0.77           |
| S342               | 310105       | Wheel 4x2.5x1.938x0.96           |
| S343               | 310106       | Wheel 4x3.62x2.44x0.77           |
| S344               | 310181       | Wheel 4x2.88x2.44x0.832          |
| S345               | 077086       | Wheel 3.25x5x2.047x0.59          |
| S346               | 310114       | Wheel 4x2.5x2.047x0.76           |
| S351               | 310104       | Wheel 5x2.62x2.834x0.77          |
| S353               | 310102       | Wheel 5x3.62x2.834x0.76          |
| S354               | 310116       | Wheel 5x3.75x2.834x0.74          |
| S359               | 310113       | Wheel 3.35x5.74x2.047x1.452      |
| S362               | 310109       | Wheel 6x4x2.834x1.17             |
| S366               | 310154       | Wheel 6x3.94x2.872x1.224         |
| S372               | 310107       | Wheel 7x2.5x2.328xNon Typical    |
| S376               | 310115       | Wheel 5x3x2.834x0.74             |
| S377               | 310116       | Wheel 4x2.5x1.938x0.74           |
| S393               | 310117       | Wheel 9x5x3.542x0.787 Black      |
| S395               | 310117       | Wheel 9x5x3.542x0.787 Black      |
| S399               | 310112       | Wheel 3.38x2.63x2.047x1.137      |
| S502               | 310108       | Wheel 4x1.88x2.44x0.76           |
| S529               | 310144       | Wheel 3.25x6x2.047x0.812         |
| S9811              | 077086       | Wheel 3.25x5x2.047x0.59          |
| S9842              | 310181       | Wheel 4x2.88x2.44x0.832          |
| S9862              | 310154       | Wheel 6x3.94x2.872x1.224         |
| SP0766-508         | 310199       | Tire Poly 8x4x6.5                |
| <b>Hyster (HY)</b> |              |                                  |
| 105                | 077086       | Wheel 3.25x5x2.047x0.59          |
| 108                | 310174       | Wheel 3.25x4x1.85x0.551          |
| 124                | 310135       | Wheel 3.25x3.25x2.047x0.825      |
| 132                | 310137       | Wheel 3.25x4.28x2.047x0.825      |
| 133                | 310136       | Wheel 3.25x4.71x2.047x0.825      |

WHEELS AND TIRES

**Note:** You need to add the compound part number to the wheel base number listed above.  
See compounds listed on page 11.03 for the dash number. Complete part number format is XXXXXX-XXX.

Hyster Continued ▶

# Wheel & Tire Cross References by Manufacturer

Continued ▶

Hyster Continued

| OE Number | Crown Number | Description                       |
|-----------|--------------|-----------------------------------|
| 134       | 310138       | Wheel 3.25x5.75x2.047x0.825       |
| 143       | 310183       | Wheel 4x2.75x2.44x0.843           |
| 153       | 312360       | Wheel 5x3.88x2.05x0.60            |
| 202       | 310164       | Wheel 5x2.88x2.047x0.59           |
| 203       | 073961       | Wheel 4x2.88x2.047x0.59           |
| 312       | 310132       | Wheel 6x3x2.047x0.595             |
| 354       | 310116       | Wheel 5x3.75x2.834x0.74           |
| 371       | 310134       | Wheel 6x3x2.44x0.775              |
| 377       | 310133       | Wheel 5x2.88x2.44x0.775           |
| 383       | 310139       | Wheel 5x2.5x1.939x0.95            |
| 386       | 310091       | Wheel 7.88x2.48x2.047xNon Typical |
| 420       | 154840       | Wheel 3.25x2x2.047x0.59           |
| 423       | 310174       | Wheel 3.25x4x1.85x0.551           |
| 425       | 310137       | Wheel 3.25x4.28x2.047x0.825       |
| 429       | 310138       | Wheel 3.25x5.75x2.047x0.825       |
| 435       | 310145       | Wheel 3.25x6.25x2.047x0.812       |
| 441       | 310136       | Wheel 3.25x4.71x2.047x0.825       |
| 442       | 310135       | Wheel 3.25x3.25x2.047x0.825       |
| 445       | 310135       | Wheel 3.25x3.25x2.047x0.825       |
| 452       | 310094       | Wheel 4x2x1.575x0.575             |
| 455       | 310139       | Wheel 5x2.5x1.939x0.95            |
| 459       | 310134       | Wheel 6x3x2.44x0.775              |
| 467       | 310132       | Wheel 6x3x2.047x0.595             |
| 553       | 310133       | Wheel 5x2.88x2.44x0.775           |
| 606       | 310091       | Wheel 7.88x2.48x2.047xNon Typical |
| 641       | 073961       | Wheel 4x2.88x2.047x0.59           |
| 647       | 310094       | Wheel 4x2x1.575x0.575             |
| 653       | 310164       | Wheel 5x2.88x2.047x0.59           |
| 806       | 310245       | Wheel 3.25x4.5x2.047x.710         |
| 815       | 310093       | Wheel 3.25x6.5x1.98x1.177         |
| 828       | 083179       | Wheel 4x2.50x2.047x0.59           |
| 9133      | 077084       | Wheel 3.25x3.25x2.047x0.59        |
| 9143      | 083179       | Wheel 4x2.50x2.047x0.59           |
| 9811      | 077086       | Wheel 3.25x5x2.047x0.59           |
| 103219    | 073961       | Wheel 4x2.88x2.047x0.59           |
| 206435    | 073961       | Wheel 4x2.88x2.047x0.59           |
| 207444    | 310135       | Wheel 3.25x3.25x2.047x0.825       |
| 211349    | 077086       | Wheel 3.25x5x2.047x0.59           |
| 213841    | 310143       | Wheel 5x2.88x2.44x0.75            |
| 223853    | 310174       | Wheel 3.25x4x1.85x0.551           |
| 230711    | 310164       | Wheel 5x2.88x2.047x0.59           |
| 239145    | 310135       | Wheel 3.25x3.25x2.047x0.825       |
| 267314    | 077086       | Wheel 3.25x5x2.047x0.59           |
| 267317    | 310135       | Wheel 3.25x3.25x2.047x0.825       |
| 267318    | 077086       | Wheel 3.25x5x2.047x0.59           |
| 281070    | 310094       | Wheel 4x2x1.575x0.575             |
| 326410    | 310094       | Wheel 4x2x1.575x0.575             |
| 338604    | 077050       | Tire Poly 13.5x5.5x8 Contour      |
| 340480    | 310139       | Wheel 5x2.5x1.939x0.95            |
| 350534    | 310138       | Wheel 3.25x5.75x2.047x0.825       |
| 350561    | 310135       | Wheel 3.25x3.25x2.047x0.825       |
| 350562    | 310137       | Wheel 3.25x4.28x2.047x0.825       |
| 350563    | 310136       | Wheel 3.25x4.71x2.047x0.825       |
| 350564    | 310138       | Wheel 3.25x5.75x2.047x0.825       |
| 354575    | 310135       | Wheel 3.25x3.25x2.047x0.825       |
| 354576    | 310137       | Wheel 3.25x4.28x2.047x0.825       |
| 354577    | 310136       | Wheel 3.25x4.71x2.047x0.825       |
| 354578    | 310138       | Wheel 3.25x5.75x2.047x0.825       |
| 358719    | 077050       | Tire Poly 13.5x5.5x8 Contour      |
| 358720    | 077050       | Tire Poly 13.5x5.5x8 Contour      |
| 365649    | 310095       | Wheel 5x2.88x2.047x0.625          |
| 389630    | 310091       | Wheel 7.88x2.48x2.047xNon Typical |
| 813378    | 310048       | Tire Poly 15x5x11.25              |
| 813421    | 310048       | Tire Poly 15x5x11.25              |
| 885900    | 310061       | Tire Poly 16x6x10.5               |
| 1032195   | 073961       | Wheel 4x2.88x2.047x0.59           |
| 1048320   | 310134       | Wheel 6x3x2.44x0.775              |
| 1098878   | 310013       | Tire Poly 10x6x6.25               |
| 1151016   | 310132       | Wheel 6x3x2.047x0.595             |
| 1152781   | 154840       | Wheel 3.25x2x2.047x0.59           |

| OE Number | Crown Number | Description                       |
|-----------|--------------|-----------------------------------|
| 1195247   | 310132       | Wheel 6x3x2.047x0.595             |
| 1195954   | 077086       | Wheel 3.25x5x2.047x0.59           |
| 1195955   | 077086       | Wheel 3.25x5x2.047x0.59           |
| 1196008   | 073961       | Wheel 4x2.88x2.047x0.59           |
| 1196100   | 310174       | Wheel 3.25x4x1.85x0.551           |
| 1196530   | 073961       | Wheel 4x2.88x2.047x0.59           |
| 1196604   | 310164       | Wheel 5x2.88x2.047x0.59           |
| 1196605   | 077086       | Wheel 3.25x5x2.047x0.59           |
| 1196637   | 310095       | Wheel 5x2.88x2.047x0.625          |
| 1196869   | 310145       | Wheel 3.25x6.25x2.047x0.812       |
| 1196908   | 154840       | Wheel 3.25x2x2.047x0.59           |
| 1197013   | 310143       | Wheel 5x2.88x2.44x0.75            |
| 1300306   | 310091       | Wheel 7.88x2.48x2.047xNon Typical |
| 1457073   | 083179       | Wheel 4x2.50x2.047x0.59           |
| 1492445   | 073961       | Wheel 4x2.88x2.047x0.59           |
| 1492447   | 310134       | Wheel 6x3x2.44x0.775              |
| 1548228   | 310239       | Wheel 6x3.89x3.149x.828           |
| 2013297   | 310094       | Wheel 4x2x1.575x0.575             |
| 2033219   | 310131       | Wheel 8.5x2.66x2.754xNon Typical  |
| 2039298   | 310240       | Wheel 3.25x6.5x2.047x1.00         |
| 2039299   | 100462       | Wheel 3.25x6.5x2.047x1.44         |
| 2039299   | 310041       | Wheel 3.25x6.5x2.047x1.681        |
| 2039300   | 310241       | Wheel 3.25x3.125x2.047x.975       |
| 2045917   | 083179       | Wheel 4x2.50x2.047x0.59           |
| 2046054   | 310245       | Wheel 3.25x4.5x2.047x.710         |
| 2066073   | 310259       | Wheel 5x4x2.44x0.63               |
| 2066239   | 310312       | Wheel 4x2.5x2.440x0.67            |
| 2086327   | 310239       | Wheel 6x3.875x3.149x0.828         |
| 2091428   | 083179       | Wheel 4x2.50x2.047x0.59           |
| 2302342   | 310183       | Wheel 4x2.75x2.44x0.843           |
| 2302392   | 310185       | Wheel 3.25x4.5x1.575x0.56         |
| 2302427   | 370355       | Wheel Rubber 5x5x5x2.19           |
| 2305605   | 310164       | Wheel 5x2.88x2.047x0.59           |
| 2306047   | 312360       | Wheel 5x3.88x2.05x0.60            |
| 2307117   | 312360       | Wheel 5x3.88x2.05x0.60            |
| 2307857   | 073961       | Wheel 4x2.88x2.047x0.59           |
| 2308415   | 310094       | Wheel 4x2x1.575x0.575             |
| 2309701   | 310095       | Wheel 5x2.88x2.047x0.625          |
| 2309954   | 107933       | Tire Poly 10x5x6.5 Contour        |
| 3005911   | 310185       | Wheel 3.25x4.5x1.575x0.56         |
| 3005984   | 310164       | Wheel 5x2.88x2.047x0.59           |
| 3005987   | 073961       | Wheel 4x2.88x2.047x0.59           |
| 3012693   | 083586       | Wheel 5x2.88x3.149x0.98           |
| 3012706   | 082742       | Wheel Steel                       |
| 3012707   | 077086       | Wheel 3.25x5x2.047x0.59           |
| 3012710   | 100462       | Wheel 3.25x6.5x2.047x1.44         |
| 3012931   | 154840       | Wheel 3.25x2x2.047x0.59           |
| 3012933   | 310174       | Wheel 3.25x4x1.85x0.551           |
| 3012947   | 310164       | Wheel 5x2.88x2.047x0.59           |
| 3012949   | 310134       | Wheel 6x3x2.44x0.775              |
| 3012966   | 310144       | Wheel 3.25x6x2.047x0.812          |
| 3013015   | 075999       | Wheel                             |
| 3013115   | 075999       | Wheel                             |
| 3013116   | 082021       | Wheel 6x2.75x3.149x0.83           |
| 3013117   | 082443       | Wheel 2.50x2.06x1.187             |
| 3013122   | 082020       | Wheel 6x4.25x3.149x0.83           |
| 3013133   | 081645       | Wheel Poly                        |
| 3013134   | 083585       | Wheel 4x2.88x2.047x0.75           |
| 3013137   | 083587       | Wheel 5x4.12x3.149x0.98           |
| 3013173   | 073961       | Wheel 4x2.88x2.047x0.59           |
| 3017646   | 310131       | Wheel 8.5x2.66x2.754xNon Typical  |
| 3020006   | 071894       | Wheel 4 Poly                      |
| 3021893   | 310071       | Tire Poly 18x8x12.125             |
| 3021924   | 310012       | Tire Poly 10x5x6.5                |
| 3021936   | 310061       | Tire Poly 16x6x10.5               |
| 3021949   | 077848       | Tire Poly 9x5x5                   |
| 3022125   | 077848       | Tire Poly 9x5x5                   |
| 3022375   | 310060       | Tire Poly 16x5x10.5               |
| 3022382   | 310014       | Tire Poly 10x6x6.5                |
| 3022517   | 310075       | Tire Poly 22x8x16                 |

**Note:** You need to add the compound part number to the wheel base number listed above.  
See compounds listed on page 11.03 for the dash number. Complete part number format is XXXXXX-XXX.

Hyster Continued ▶

# Wheel & Tire Cross References by Manufacturer

Continued ▶

Hyster Continued

| OE Number | Crown Number | Description                       |
|-----------|--------------|-----------------------------------|
| 3022554   | 107933       | Tire Poly 10x5x6.5 Contour        |
| 3022555   | 310022       | Tire Poly 10.5x6x6.5              |
| 3022556   | 310025       | Tire Poly 12x4.5x8                |
| 3022557   | 310042       | Tire Poly 14x4.5x8                |
| 3022558   | 310068       | Tire Poly 18x6x12.125             |
| 3022571   | 075715       | Tire Poly 10x4x6.5                |
| 3022601   | 310061       | Tire Poly 16x6x10.5               |
| 3022612   | 310072       | Tire Poly 18x9x12.125             |
| 3022782   | 077984       | Tire Poly 8.5x4x4                 |
| 3022806   | 310014       | Tire Poly 10x6x6.5                |
| 3022937   | 310076       | Tire Poly 22x10x16                |
| 3023045   | 310060       | Tire Poly 16x5x10.5               |
| 3025553   | 310067       | Tire Poly 18x5x12.125             |
| 3025565   | 310207       | Tire Poly 22x9x16                 |
| 3026131   | 310024       | Tire Poly 10.5x7x6.5              |
| 3026509   | 077050       | Tire Poly 13.5x5.5x8 Contour      |
| 3027350   | 310048       | Tire Poly 15x5x11.25              |
| 3027736   | 310024       | Tire Poly 10.5x7x6.5              |
| 3027773   | 154840       | Wheel 3.25x2x2.047x0.59           |
| 3028194   | 077848       | Tire Poly 9x5x5                   |
| 3028200   | 075715       | Tire Poly 10x4x6.5                |
| 3028227   | 310207       | Tire Poly 22x9x16                 |
| 3028670   | 077848       | Tire Poly 9x5x5                   |
| 3029013   | 077848       | Tire Poly 9x5x5                   |
| 3029017   | 075715       | Tire Poly 10x4x6.5                |
| 3030218   | 077984       | Tire Poly 8.5x4x4                 |
| 3030223   | 075715       | Tire Poly 10x4x6.5                |
| 3030828   | 075715       | Tire Poly 10x4x6.5                |
| 3031330   | 310131       | Wheel 8.5x2.66x2.754xNon Typical  |
| 3032897   | 310178       | Wheel 3.25x5.91x2.047x1.18        |
| 3051525   | 310093       | Wheel 3.25x6.5x1.98x1.177         |
| 3056709   | 310091       | Wheel 7.88x2.48x2.047xNon Typical |
| 3056852   | 310164       | Wheel 5x2.88x2.047x0.59           |
| 3068626   | 077086       | Wheel 3.25x5x2.047x0.59           |
| 3102707   | 077086       | Wheel 3.25x5x2.047x0.59           |
| 3120636   | 107933       | Tire Poly 10x5x6.5 Contour        |
| 3120637   | 077848       | Tire Poly 9x5x5                   |
| 3120638   | 310025       | Tire Poly 12x4.5x8                |
| 3121144   | 082021       | Load Wheel Assm 6x2.75            |
| 3126223   | 081520       | Wheel Caster Assm 10 x 3          |
| 3133013   | 115033       | Wheel 5x4.12x2.44x0.83            |
| 3133017   | 310181       | Wheel 4x2.88x2.44x0.832           |
| 4609400   | 310245       | Wheel 3.25x4.5x2.047x.710         |
| 754507300 | 310091       | Wheel 7.88x2.48x2.047xNon Typical |
| 800017067 | 123603       | Load Wheel Assm 3.25 x 4.50       |
| 800017230 | 125070       | Wheel 6x4.12x3.149x0.98           |
| 800017585 | 127723       | Wheel Caster 8x4x2.83             |
| 800020380 | 077084       | Load Wheel Assm 3.25x3.25         |
| 800020380 | 092537       | Wheel Assm 3.25x3.25x2.047x0.59   |
| 800026169 | 310131       | Wheel 8.5x2.66x2.754xNon Typical  |
| 800045244 | 083586       | Wheel 5x2.88x3.149x0.98           |
| 800045250 | 310131       | Wheel 8.5x2.66x2.754xNon Typical  |
| 800045277 | 125070       | Wheel 6x4.12x3.149x0.98           |
| 800045371 | 083879       | Roller Load                       |
| 800046166 | 073602       | Wheel 5 Steel Assm                |
| 800046167 | 125069       | Wheel 6x2.88x3.15x0.80            |
| 800050148 | 100462       | Wheel 3.25x6.5x2.047x1.44         |
| 800050156 | 115032       | Wheel 5x2.88x2.44x0.83            |
| 800076056 | 071894       | Wheel 4 Poly                      |
| 800076068 | 073602       | Wheel 5 Steel Assm                |
| 800076205 | 082741       | Wheel Nylon                       |
| 800076404 | 082283       | Wheel Assm (Poly)                 |
| 800113692 | 044507       | Roller Poly                       |
| 800114768 | 072718       | Wheel Assm Poly                   |
| 800114775 | 071892       | Wheel 5 dia                       |
| 800114779 | 071665       | Wheel Polyurethane                |
| 800114783 | 082021       | Wheel 6x2.75x3.149x0.83           |
| 800114787 | 077084       | Load Wheel Assm 3.25x3.25         |
| 800114787 | 092537       | Wheel Assm 3.25x3.25x2.047x0.59   |
| 800114789 | 125069       | Wheel 6x2.88x3.15x0.80            |

| OE Number | Crown Number | Description                       |
|-----------|--------------|-----------------------------------|
| 800114802 | 311520       | Wheel 10x3 Caster                 |
| 800114805 | 077084       | Load Wheel Assm 3.25x3.25         |
| 800114805 | 092537       | Wheel Assm 3.25x3.25x2.047x0.59   |
| 800114810 | 077086       | Wheel 3.25x5x2.047x0.59           |
| 800114812 | 115033       | Wheel 5x4.12x2.44x0.83            |
| 800114818 | 100462       | Wheel 3.25x6.5x2.047x1.44         |
| 800114833 | 083179       | Wheel 4x2.50x2.047x0.59           |
| 800114837 | 083585       | Wheel 4x2.88x2.047x0.75           |
| 800114838 | 083585       | Wheel 4x2.88x2.047x0.75           |
| 800114845 | 088628       | Wheel 4x4.12x2.047x0.75           |
| 800114846 | 088628       | Wheel 4x4.12x2.047x0.75           |
| 800114848 | 115032       | Wheel 5x2.88x2.44x0.83            |
| 800114851 | 083587       | Wheel 5x4.12x3.149x0.98           |
| 800114853 | 083586       | Wheel 5x2.88x3.149x0.98           |
| 800114856 | 115033       | Wheel 5x4.12x2.44x0.83            |
| 800114858 | 115033       | Wheel 5x4.12x2.44x0.83            |
| 800120656 | 123603       | Wheel 3.25x4.50x2.16x0.52         |
| 800120779 | 310131       | Wheel 8.5x2.66x2.754xNon Typical  |
| 800120802 | 115032       | Wheel 5x2.88x2.44x0.83            |
| C32195    | 073961       | Wheel 4x2.88x2.047x0.59           |
| C-32195   | 073961       | Wheel 4x2.88x2.047x0.59           |
| C33557    | 310132       | Wheel 6x3x2.047x0.595             |
| C33735    | 310164       | Wheel 5x2.88x2.047x0.59           |
| C33746    | 077086       | Wheel 3.25x5x2.047x0.59           |
| C34835    | 077084       | Wheel 3.25x3.25x2.047x0.59        |
| C34836    | 310135       | Wheel 3.25x3.25x2.047x0.825       |
| C426173   | 154840       | Wheel 3.25x2x2.047x0.59           |
| C426174   | 154840       | Wheel 3.25x2x2.047x0.59           |
| C46239    | 310133       | Wheel 5x2.88x2.44x0.775           |
| C46239    | 310143       | Wheel 5x2.88x2.44x0.75            |
| C48320    | 310134       | Wheel 6x3x2.44x0.775              |
| C60088    | 310174       | Wheel 3.25x4x1.85x0.551           |
| C-60088   | 310174       | Wheel 3.25x4x1.85x0.551           |
| HYC-20196 | 077086       | Wheel 3.25x5x2.047x0.59           |
| HYC-20197 | 077086       | Wheel 3.25x5x2.047x0.59           |
| L309088   | 310116       | Wheel 5x3.75x2.834x0.74           |
| S143      | 310183       | Wheel 4x2.75x2.44x0.843           |
| S153      | 312360       | Wheel 5x3.88x2.05x0.60            |
| S420      | 154840       | Wheel 3.25x2x2.047x0.59           |
| S423      | 310174       | Wheel 3.25x4x1.85x0.551           |
| S425      | 310137       | Wheel 3.25x4.28x2.047x0.825       |
| S429      | 310138       | Wheel 3.25x5.75x2.047x0.825       |
| S434      | 077086       | Wheel 3.25x5x2.047x0.59           |
| S435      | 310145       | Wheel 3.25x6.25x2.047x0.812       |
| S438      | 310135       | Wheel 3.25x3.25x2.047x0.825       |
| S441      | 310136       | Wheel 3.25x4.71x2.047x0.825       |
| S442      | 310135       | Wheel 3.25x3.25x2.047x0.825       |
| S443      | 073961       | Wheel 4x2.88x2.047x0.59           |
| S444      | 310137       | Wheel 3.25x4.28x2.047x0.825       |
| S445      | 310136       | Wheel 3.25x4.71x2.047x0.825       |
| S446      | 310137       | Wheel 3.25x4.28x2.047x0.825       |
| S447      | 077086       | Wheel 3.25x5x2.047x0.59           |
| S448      | 310138       | Wheel 3.25x5.75x2.047x0.825       |
| S450      | 310133       | Wheel 5x2.88x2.44x0.775           |
| S451      | 310164       | Wheel 5x2.88x2.047x0.59           |
| S452      | 310094       | Wheel 4x2x1.575x0.575             |
| S456      | 310139       | Wheel 5x2.5x1.939x0.95            |
| S457      | 312360       | Wheel 5x3.88x2.05x0.60            |
| S459      | 310134       | Wheel 6x3x2.44x0.775              |
| S467      | 310132       | Wheel 6x3x2.047x0.595             |
| S487      | 310091       | Wheel 7.88x2.48x2.047xNon Typical |
| S529      | 310144       | Wheel 3.25x6x2.047x0.812          |
| S553      | 310133       | Wheel 5x2.88x2.44x0.775           |
| S647      | 310094       | Wheel 4x2x1.575x0.575             |
| S648      | 310094       | Wheel 4x2x1.575x0.575             |
| S653      | 310164       | Wheel 5x2.88x2.047x0.59           |
| S673      | 310172       | Wheel 6x3.63x2.44x0.668           |
| S700      | 310178       | Wheel 3.25x5.91x2.047x1.18        |
| S815      | 310093       | Wheel 3.25x6.5x1.98x1.177         |
| S820      | 310185       | Wheel 3.25x4.5x1.575x0.56         |

WHEELS AND TIRES

Hyster Continued ▶

**Note:** You need to add the compound part number to the wheel base number listed above. See compounds listed on page 11.03 for the dash number. Complete part number format is XXXXXX-XXX.

# Wheel & Tire Cross References by Manufacturer

Continued ▶

Hyster Continued

| OE Number                | Crown Number | Description                    |
|--------------------------|--------------|--------------------------------|
| S9534                    | 310174       | Wheel 3.25x4x1.85x0.551        |
| S9842                    | 310181       | Wheel 4x2.88x2.44x0.832        |
| <b>Jungheinrich (JU)</b> |              |                                |
| 32086                    | 310296       | Tire Poly 9x2.875x6.63         |
| 822785                   | 082285       | Wheel (Nylon)                  |
| 50432647                 | 310467       | Caster Wheel Assembly          |
| 6311846                  | 807557       | Drive Tire Assembly ESR4500    |
| 6314589                  | 807557       | Drive Tire Assembly ESR4500    |
| 7180668                  | 370231       | Load Wheel Assembly            |
| 50136157                 | 370231       | Load Wheel Assembly            |
| 50460101                 | 370220       | JU50460101 Drive Tire          |
| 63118460                 | 807557       | Drive Tire Assembly ESR4500    |
| 63145890                 | 807557       | Drive Tire Assembly ESR4500    |
| 71305290                 | 370231       | Load Wheel Assembly            |
| 71806680                 | 370231       | Load Wheel Assembly            |
| <b>Komatsu (KO)</b>      |              |                                |
| 8773965                  | 136247       | Tube 6.00-9 Tire - 600/690x9   |
| 8779048                  | 136243       | Tube 7.00-12 Tire - 700/825x12 |
| 8779866                  | 355500       | Solid Resi 500x8 3" TR         |
| MIT27218501              | 355500       | Solid Resi 500x8 3" TR         |
| MIT42300000              | 136247       | Tube 6-9 Tire - 600/690x9      |
| MIT42400000              | 136243       | Tube 7.00-12 Tire - 700/825x12 |
| OP03000205               | 310029       | Tire Poly 12x5x9               |
| <b>Lansing (LA)</b>      |              |                                |
| 1004018-001              | 154840       | Wheel 3.25x2x2.047x0.59        |
| 1410                     | 154840       | Wheel 3.25x2x2.047x0.59        |
| 1415                     | 310174       | Wheel 3.25x4x1.85x0.551        |
| 2029211-001              | 310142       | Wheel 4x2.88x2.44x0.75         |
| 2029242-001              | 310096       | Wheel 6x2x2.44x0.625           |
| 78435                    | 310098       | Wheel 4x2.75x1.938xThru        |
| S1404                    | 310174       | Wheel 3.25x4x1.85x0.551        |
| S1410                    | 154840       | Wheel 3.25x2x2.047x0.59        |
| S1415                    | 310174       | Wheel 3.25x4x1.85x0.551        |
| <b>Lift Rite (LR)</b>    |              |                                |
| 102                      | 310182       | Wheel 3x4x1.85x0.56            |
| 10210                    | 310182       | Wheel 3x4x1.85x0.56            |
| 10210P                   | 310182       | Wheel 3x4x1.85x0.56            |
| 302                      | 310090       | Wheel 8x2x2.047x0.595          |
| 302                      | 310092       | Wheel 8x2x2.047x0.67           |
| 783                      | 310090       | Wheel 8x2x2.047x0.595          |
| 783                      | 310092       | Wheel 8x2x2.047x0.67           |
| 82                       | 310090       | Wheel 8x2x2.047x0.595          |
| 82                       | 310092       | Wheel 8x2x2.047x0.67           |
| B40220                   | 310090       | Wheel 8x2x2.047x0.595          |
| B40220                   | 310092       | Wheel 8x2x2.047x0.67           |
| S10210                   | 310182       | Wheel 3x4x1.85x0.56            |
| S10212                   | 310182       | Wheel 3x4x1.85x0.56            |
| S10237                   | 310090       | Wheel 8x2x2.047x0.595          |
| S10237                   | 310092       | Wheel 8x2x2.047x0.67           |
| <b>Linde (LI)</b>        |              |                                |
| 102                      | 310189       | Wheel 3x3.5x1.85x0.56          |
| 103                      | 310141       | Wheel 3.25x3x2.047x0.812       |
| 106                      | 310146       | Wheel 3.25x6.38x2.047x0.812    |
| 107                      | 310140       | Wheel 3.25x3.88x2.047x.812     |
| 109                      | 310145       | Wheel 3.25x6.25x2.047x0.812    |
| 111                      | 154840       | Wheel 3.25x2x2.047x0.59        |
| 117                      | 310185       | Wheel 3.25x4.5x1.575x0.56      |
| 138                      | 154840       | Wheel 3.25x2x2.047x0.59        |
| 202                      | 310164       | Wheel 5x2.88x2.047x0.59        |
| 203                      | 073961       | Wheel 4x2.88x2.047x0.59        |
| 207                      | 071894       | Wheel 4 Poly                   |
| 306                      | 310132       | Wheel 6x3x2.047x0.595          |
| 306                      | 310177       | Wheel 6x3x2.047x0.67           |
| 319                      | 310179       | Wheel 8x4x2.44x0.656           |
| 377                      | 310133       | Wheel 5x2.88x2.44x0.775        |
| 377                      | 310143       | Wheel 5x2.88x2.44x0.75         |
| 443                      | 073961       | Wheel 4x2.88x2.047x0.59        |
| 502                      | 310108       | Wheel 4x1.88x2.44x0.76         |
| 532                      | 310149       | Wheel 3.25x3x2.047x0.656       |

| OE Number  | Crown Number | Description                 |
|------------|--------------|-----------------------------|
| 534        | 310145       | Wheel 3.25x6.25x2.047x0.812 |
| 535        | 310141       | Wheel 3.25x3x2.047x0.812    |
| 538        | 310140       | Wheel 3.25x3.88x2.047x.812  |
| 539        | 310190       | Wheel 3.25x6.38x2.047x1.187 |
| 542        | 310142       | Wheel 4x2.88x2.44x0.75      |
| 553        | 310133       | Wheel 5x2.88x2.44x0.775     |
| 553        | 310143       | Wheel 5x2.88x2.44x0.75      |
| 560        | 310132       | Wheel 6x3x2.047x0.595       |
| 560        | 310177       | Wheel 6x3x2.047x0.67        |
| 581        | 310179       | Wheel 8x4x2.44x0.656        |
| 630        | 310162       | Wheel 3.38x2.25x1.85x0.551  |
| 641        | 073961       | Wheel 4x2.88x2.047x0.59     |
| 647        | 310094       | Wheel 4x2x1.575x0.575       |
| 653        | 310164       | Wheel 5x2.88x2.047x0.59     |
| 820        | 310185       | Wheel 3.25x4.5x1.575x0.56   |
| 900        | 310147       | Wheel 3.25x6x2.047x1.187    |
| 985        | 310080       | Wheel 3x2x2.047x0.625       |
| 9143       | 083179       | Wheel 4x2.50x2.047x0.59     |
| 9433       | 310189       | Wheel 3x3.5x1.85x0.56       |
| 9841       | 071894       | Wheel 4 Poly                |
| 3-4        | 310179       | Wheel 8x4x2.44x0.656        |
| 4-1        | 310179       | Wheel 8x4x2.44x0.656        |
| 116808     | 310207       | Tire Poly 22x9x16           |
| 127223     | 310121       | Tire Poly 21x8x15           |
| 138937     | 310142       | Wheel 4x2.88x2.44x0.75      |
| 146735     | 083179       | Wheel 4x2.50x2.047x0.59     |
| 152681     | 310218       | Wheel 3.25x6.38x2.047x1.062 |
| 154423     | 310218       | Wheel 3.25x6.38x2.047x1.062 |
| 160948     | 310231       | Wheel 3.25x4.84x2.047x0.8   |
| 632078     | 310179       | Wheel 8x4x2.44x0.656        |
| 703637     | 310108       | Wheel 4x1.88x2.44x0.76      |
| 708086     | 310146       | Wheel 3.25x6.38x2.047x0.812 |
| 708367     | 073961       | Wheel 4x2.88x2.047x0.59     |
| 985189     | 310164       | Wheel 5x2.88x2.047x0.59     |
| 993474     | 310132       | Wheel 6x3x2.047x0.595       |
| 993474     | 310177       | Wheel 6x3x2.047x0.67        |
| 994070     | 310179       | Wheel 8x4x2.44x0.656        |
| 9904070    | 310179       | Wheel 8x4x2.44x0.656        |
| 9815001933 | 310067       | Tire Poly 18x5x12.125       |
| 106A       | 310144       | Wheel 3.25x6x2.047x0.812    |
| 13HP       | 310189       | Wheel 3x3.5x1.85x0.56       |
| 632-078    | 310179       | Wheel 8x4x2.44x0.656        |
| BHP014     | 310189       | Wheel 3x3.5x1.85x0.56       |
| LIAW-3-4   | 310179       | Wheel 8x4x2.44x0.656        |
| LIAW-4-1   | 310179       | Wheel 8x4x2.44x0.656        |
| LIS530     | 310250       | Wheel 3.25x1.88x2.047x0.595 |
| M0108      | 310080       | Wheel 3x2x2.047x0.625       |
| PAL 13     | 310145       | Wheel 3.25x6.25x2.047x0.812 |
| PAL13-A    | 310149       | Wheel 3.25x3x2.047x0.656    |
| PAL13-C    | 310149       | Wheel 3.25x3x2.047x0.656    |
| PAL13-GH   | 310140       | Wheel 3.25x3.88x2.047x.812  |
| PAL13-GL   | 310141       | Wheel 3.25x3x2.047x0.812    |
| PAL13-GLD  | 310149       | Wheel 3.25x3x2.047x0.656    |
| PAL13-K    | 310140       | Wheel 3.25x3.88x2.047x.812  |
| PAL13-KG   | 310140       | Wheel 3.25x3.88x2.047x.812  |
| PAL13-M    | 310144       | Wheel 3.25x6x2.047x0.812    |
| S443       | 073961       | Wheel 4x2.88x2.047x0.59     |
| S524       | 310162       | Wheel 3.38x2.25x1.85x0.551  |
| S525       | 310080       | Wheel 3x2x2.047x0.625       |
| S528       | 310146       | Wheel 3.25x6.38x2.047x0.812 |
| S529       | 310144       | Wheel 3.25x6x2.047x0.812    |
| S530       | 310250       | Wheel 3.25x1.88x2.047x0.595 |
| S532       | 310149       | Wheel 3.25x3x2.047x0.656    |
| S533       | 310189       | Wheel 3x3.5x1.85x0.56       |
| S534       | 310145       | Wheel 3.25x6.25x2.047x0.812 |
| S534-S     | 310146       | Wheel 3.25x6.38x2.047x0.812 |
| S535       | 310141       | Wheel 3.25x3x2.047x0.812    |
| S538       | 310140       | Wheel 3.25x3.88x2.047x.812  |
| S542       | 310142       | Wheel 4x2.88x2.44x0.75      |

**Note:** You need to add the compound part number to the wheel base number listed above. See compounds listed on page 11.03 for the dash number. Complete part number format is XXXXX-XXX.

Linde Continued ▶



# Wheel & Tire Cross References by Manufacturer

Continued ▶

Linde Continued

| OE Number              | Crown Number | Description                    |
|------------------------|--------------|--------------------------------|
| S544                   | 073961       | Wheel 4x2.88x2.047x0.59        |
| S548                   | 310094       | Wheel 4x2x1.575x0.575          |
| S552                   | 310164       | Wheel 5x2.88x2.047x0.59        |
| S553                   | 310133       | Wheel 5x2.88x2.44x0.775        |
| S553                   | 310143       | Wheel 5x2.88x2.44x0.75         |
| S560                   | 310132       | Wheel 6x3x2.047x0.595          |
| S560                   | 310177       | Wheel 6x3x2.047x0.67           |
| S581                   | 310179       | Wheel 8x4x2.44x0.656           |
| S591                   | 310108       | Wheel 4x1.88x2.44x0.76         |
| S820                   | 310185       | Wheel 3.25x4.5x1.575x0.56      |
| S985                   | 310080       | Wheel 3x2x2.047x0.625          |
| W2-G                   | 310080       | Wheel 3x2x2.047x0.625          |
| W3-6G                  | 310132       | Wheel 6x3x2.047x0.595          |
| W3-6G                  | 310177       | Wheel 6x3x2.047x0.67           |
| W413923                | 310162       | Wheel 3.38x2.25x1.85x0.551     |
| <b>Mitsubishi (MB)</b> |              |                                |
| 301                    | 310102       | Wheel 5x3.62x2.834x0.76        |
| 302                    | 310087       | Wheel 7x2.86x2.047xNon Typical |
| 353                    | 310102       | Wheel 5x3.62x2.834x0.76        |
| 560                    | 310177       | Wheel 6x3x2.047x0.67           |
| 635                    | 310077       | Wheel 3.25x5.88x2.047x0.599    |
| 700                    | 310178       | Wheel 3.25x5.91x2.047x1.18     |
| 9143                   | 083179       | Wheel 4x2.50x2.047x0.59        |
| 9811                   | 077086       | Wheel 3.25x5x2.047x0.59        |
| 9827                   | 310087       | Wheel 7x2.86x2.047xNon Typical |
| 67018                  | 083179       | Wheel 4x2.50x2.047x0.59        |
| 289069                 | 310178       | Wheel 3.25x5.91x2.047x1.18     |
| 1009234                | 310178       | Wheel 3.25x5.91x2.047x1.18     |
| 1009591                | 310178       | Wheel 3.25x5.91x2.047x1.18     |
| 1029602                | 310178       | Wheel 3.25x5.91x2.047x1.18     |
| 1029607                | 310178       | Wheel 3.25x5.91x2.047x1.18     |
| 1029609                | 310178       | Wheel 3.25x5.91x2.047x1.18     |
| 1029612                | 310178       | Wheel 3.25x5.91x2.047x1.18     |
| 1050142                | 310179       | Wheel 8x4x2.44x0.656           |
| 1050236                | 310179       | Wheel 8x4x2.44x0.656           |
| 1075061                | 077086       | Wheel 3.25x5x2.047x0.59        |
| 1075062                | 077086       | Wheel 3.25x5x2.047x0.59        |
| 1075063                | 077086       | Wheel 3.25x5x2.047x0.59        |
| 1075064                | 077086       | Wheel 3.25x5x2.047x0.59        |
| 1201773                | 310178       | Wheel 3.25x5.91x2.047x1.18     |
| 10092234               | 310178       | Wheel 3.25x5.91x2.047x1.18     |
| 50136157               | 370231       | Load Wheel Assembly            |
| 50179921               | 370231       | Load Wheel Assembly            |
| 50432647               | 310467       | Caster Wheel Assembly          |
| 71305290               | 370231       | Load Wheel Assembly            |
| 452204620              | 083179       | Wheel 4x2.50x2.047x0.59        |
| 10236B                 | 310092       | Wheel 8x2x2.047x0.67           |
| 4522-04620             | 083179       | Wheel 4x2.50x2.047x0.59        |
| 4522-33000             | 310077       | Wheel 3.25x5.88x2.047x0.599    |
| 4522-35050             | 310177       | Wheel 6x3x2.047x0.67           |
| 4621-27282             | 310087       | Wheel 7x2.86x2.047xNon Typical |
| 4690-03540             | 310087       | Wheel 7x2.86x2.047xNon Typical |
| 4770-30250             | 310115       | Wheel 5x3x2.834x0.74           |
| 4780-30230             | 310102       | Wheel 5x3.62x2.834x0.76        |
| 4B43971                | 310102       | Wheel 5x3.62x2.834x0.76        |
| MBNA067018             | 083179       | Wheel 4x2.50x2.047x0.59        |
| S353                   | 310102       | Wheel 5x3.62x2.834x0.76        |
| S9751                  | 310077       | Wheel 3.25x5.88x2.047x0.599    |
| S9752                  | 083179       | Wheel 4x2.50x2.047x0.59        |
| S9754                  | 310102       | Wheel 5x3.62x2.834x0.76        |
| S9755                  | 310177       | Wheel 6x3x2.047x0.67           |
| S9773                  | 310087       | Wheel 7x2.86x2.047xNon Typical |
| S9827                  | 310087       | Wheel 7x2.86x2.047xNon Typical |
| W2050-11106            | 370231       | Load Wheel Assembly            |
| W2050-12884            | 310467       | Caster Wheel Assembly          |
| <b>Multiton (MT)</b>   |              |                                |
| 9534                   | 310174       | Wheel 3.25x4x1.85x0.551        |
| 90304                  | 310174       | Wheel 3.25x4x1.85x0.551        |
| 90326                  | 310174       | Wheel 3.25x4x1.85x0.551        |
| 325P                   | 310174       | Wheel 3.25x4x1.85x0.551        |

| OE Number                | Crown Number | Description                      |
|--------------------------|--------------|----------------------------------|
| A212                     | 310174       | Wheel 3.25x4x1.85x0.551          |
| MTA212                   | 310174       | Wheel 3.25x4x1.85x0.551          |
| S9534                    | 310174       | Wheel 3.25x4x1.85x0.551          |
| <b>Nissan (NI)</b>       |              |                                  |
| 253                      | 310144       | Wheel 3.25x6x2.047x0.812         |
| 4035-FS000               | 310144       | Wheel 3.25x6x2.047x0.812         |
| SP0766-508               | 310199       | Tire Poly 8x4x6.5                |
| <b>Palletmaster (PS)</b> |              |                                  |
| 82                       | 310090       | Wheel 8x2x2.047x0.595            |
| 82                       | 310092       | Wheel 8x2x2.047x0.67             |
| <b>Prime Mover (PM)</b>  |              |                                  |
| 103                      | 310150       | Wheel 3.25x2.94x1.98xNon Typical |
| 104                      | 310149       | Wheel 3.25x3x2.047x0.656         |
| 105                      | 077086       | Wheel 3.25x5x2.047x0.59          |
| 201                      | 310153       | Wheel 4x2.88x2.325x0.832         |
| 202                      | 310152       | Wheel 4x2.75x1.938xThru          |
| 203                      | 310181       | Wheel 4x2.88x2.44x0.832          |
| 206                      | 310221       | Wheel 4x1.92x1.781x.84           |
| 207                      | 071894       | Wheel 4 Poly                     |
| 211                      | 310186       | Wheel 4x2.37x1.938x0.96          |
| 301                      | 310148       | Wheel 8x1.90x1.98x0.81           |
| 305                      | 310151       | Wheel 5x2.88x2.325x0.832         |
| 306                      | 310154       | Wheel 6x3.94x2.872x1.224         |
| 309                      | 310155       | Wheel 7x2.5x2.326xNon Typical    |
| 321                      | 310104       | Wheel 5x2.62x2.834x0.77          |
| 351                      | 310104       | Wheel 5x2.62x2.834x0.77          |
| 353                      | 310102       | Wheel 5x3.62x2.834x0.76          |
| 644                      | 310221       | Wheel 4x1.92x1.781x.84           |
| 824                      | 310186       | Wheel 4x2.37x1.938x0.96          |
| 900                      | 310147       | Wheel 3.25x6x2.047x1.187         |
| 901                      | 310090       | Wheel 8x2x2.047x0.595            |
| 2335                     | 310244       | Wheel 3.25x4.5x2.047x.594        |
| 9112                     | 082443       | Wheel 2.50x2.06x1.187            |
| 9143                     | 083179       | Wheel 4x2.50x2.047x0.59          |
| 9800                     | 310212       | Wheel 3.25x3x2.047x.590          |
| 9803                     | 310153       | Wheel 4x2.88x2.325x0.832         |
| 9804                     | 310150       | Wheel 3.25x2.94x1.98xNon Typical |
| 9805                     | 310151       | Wheel 5x2.88x2.325x0.832         |
| 9806                     | 310149       | Wheel 3.25x3x2.047x0.656         |
| 9808                     | 310152       | Wheel 4x2.75x1.938xThru          |
| 9810                     | 310085       | Wheel 3.25x6x2.047x0.585         |
| 9811                     | 077086       | Wheel 3.25x5x2.047x0.59          |
| 9841                     | 071894       | Wheel 4 Poly                     |
| 9842                     | 310181       | Wheel 4x2.88x2.44x0.832          |
| 9844                     | 310235       | Wheel 4x2.88x2.44x0.672          |
| 9862                     | 310154       | Wheel 6x3.94x2.872x1.224         |
| 9870                     | 310155       | Wheel 7x2.5x2.326xNon Typical    |
| 9880                     | 310148       | Wheel 8x1.90x1.98x0.81           |
| 13864                    | 310148       | Wheel 8x1.90x1.98x0.81           |
| 15881                    | 310189       | Wheel 3x3.5x1.85x0.56            |
| 20001                    | 310186       | Wheel 4x2.37x1.938x0.96          |
| 22006                    | 107933       | Tire Poly 10x5x6.5 Contour       |
| 25922                    | 310020       | Tire Poly 10.5x5x6.5             |
| 27625                    | 310149       | Wheel 3.25x3x2.047x0.656         |
| 27808                    | 083179       | Wheel 4x2.50x2.047x0.59          |
| 40868                    | 310181       | Wheel 4x2.88x2.44x0.832          |
| 42125                    | 310102       | Wheel 5x3.62x2.834x0.76          |
| 200015                   | 310186       | Wheel 4x2.37x1.938x0.96          |
| 204274                   | 083179       | Wheel 4x2.50x2.047x0.59          |
| 301738                   | 310020       | Tire Poly 10.5x5x6.5             |
| 303692                   | 310104       | Wheel 5x2.62x2.834x0.77          |
| 305622                   | 310053       | Tire Poly 13.5x5.5x10            |
| 305624                   | 310039       | Tire Poly 13.5x5.5x8             |
| 306752                   | 310053       | Tire Poly 13.5x5.5x10            |
| 306895                   | 310017       | Tire Poly 10.5x3.5x8             |
| 309826                   | 310053       | Tire Poly 13.5x5.5x10            |
| 312636                   | 310244       | Wheel 3.25x4.5x2.047x.594        |
| 1612413                  | 310104       | Wheel 5x2.62x2.834x0.77          |
| 2324109                  | 310102       | Wheel 5x3.62x2.834x0.76          |
| 20071-01                 | 310020       | Tire Poly 10.5x5x6.5             |

WHEELS AND TIRES

**Note:** You need to add the compound part number to the wheel base number listed above. See compounds listed on page 11.03 for the dash number. Complete part number format is XXXXXX-XXX.

Prime Mover Continued ▶

# Wheel & Tire Cross References by Manufacturer

Continued ▶

Prime Mover Continued

| OE Number  | Crown Number | Description                      |
|------------|--------------|----------------------------------|
| 23041-00   | 077086       | Wheel 3.25x5x2.047x0.59          |
| 24269-00   | 310003       | Tire Poly 8x4.5x4.5              |
| 25202-02   | 310153       | Wheel 4x2.88x2.325x0.832         |
| 25922-01   | 310020       | Tire Poly 10.5x5x6.5             |
| 27626-02   | 310085       | Wheel 3.25x6x2.047x0.585         |
| 27626-03   | 310147       | Wheel 3.25x6x2.047x1.187         |
| 27808-00   | 083179       | Wheel 4x2.50x2.047x0.59          |
| 302623-002 | 310212       | Wheel 3.25x3x2.047x.590          |
| 303692-00  | 310104       | Wheel 5x2.62x2.834x0.77          |
| 305620-00  | 310227       | Wheel 7x2.75x1.98                |
| 307110-03  | 310147       | Wheel 3.25x6x2.047x1.187         |
| 312636-000 | 310316       | Wheel 3.25x4.48x2.047x0.582      |
| 314275-000 | 310179       | Wheel 8x4x2.44x0.656             |
| 314334-000 | 310179       | Wheel 8x4x2.44x0.656             |
| 40254-00   | 107933       | Tire Poly 10x5x6.5 Contour       |
| 40254-01   | 310018       | Tire Poly 10.5x4.5x8             |
| 40265-00   | 107933       | Tire Poly 10x5x6.5 Contour       |
| 40266-01   | 310039       | Tire Poly 13.5x5.5x8             |
| 40721-00   | 310155       | Wheel 7x2.5x2.326xNon Typical    |
| 40868-2    | 310181       | Wheel 4x2.88x2.44x0.832          |
| 42125-00   | 310102       | Wheel 5x3.62x2.834x0.76          |
| 42136-00   | 310235       | Wheel 4x2.88x2.44x0.672          |
| 4522-04620 | 083179       | Wheel 4x2.50x2.047x0.59          |
| A26327     | 071894       | Wheel 4 Poly                     |
| B20755     | 310150       | Wheel 3.25x2.94x1.98xNon Typical |
| B20972     | 310150       | Wheel 3.25x2.94x1.98xNon Typical |
| B25195     | 310152       | Wheel 4x2.75x1.938xThru          |
| B25199     | 310153       | Wheel 4x2.88x2.325x0.832         |
| B25761     | 310151       | Wheel 5x2.88x2.325x0.832         |
| B26327     | 071894       | Wheel 4 Poly                     |
| B26460     | 310154       | Wheel 6x3.94x2.872x1.224         |
| B27042     | 310149       | Wheel 3.25x3x2.047x0.656         |
| B27042     | 310212       | Wheel 3.25x3x2.047x.590          |
| B27049     | 071894       | Wheel 4 Poly                     |
| B-27606    | 310212       | Wheel 3.25x3x2.047x.590          |
| B27626-00  | 310147       | Wheel 3.25x6x2.047x1.187         |
| B27626-01  | 310085       | Wheel 3.25x6x2.047x0.585         |
| B-27626-03 | 310147       | Wheel 3.25x6x2.047x1.187         |
| B27674     | 310221       | Wheel 4x1.92x1.781x.84           |
| MB-26460   | 310159       | Wheel 5x2x2.047x0.59             |
| P-13863    | 310148       | Wheel 8x1.90x1.98x0.81           |
| P-13864    | 310148       | Wheel 8x1.90x1.98x0.81           |
| P21038     | 310152       | Wheel 4x2.75x1.938xThru          |
| P25199     | 310153       | Wheel 4x2.88x2.325x0.832         |
| PMA-26327  | 071894       | Wheel 4 Poly                     |
| S901       | 310090       | Wheel 8x2x2.047x0.595            |
| S9143      | 083179       | Wheel 4x2.50x2.047x0.59          |
| S9803      | 310153       | Wheel 4x2.88x2.325x0.832         |
| S9804      | 310150       | Wheel 3.25x2.94x1.98xNon Typical |
| S9805      | 310151       | Wheel 5x2.88x2.325x0.832         |
| S9806      | 310149       | Wheel 3.25x3x2.047x0.656         |
| S9811      | 077086       | Wheel 3.25x5x2.047x0.59          |
| S9812      | 310085       | Wheel 3.25x6x2.047x0.585         |
| S9813      | 310152       | Wheel 4x2.75x1.938xThru          |
| S9814      | 077086       | Wheel 3.25x5x2.047x0.59          |
| S9815      | 310147       | Wheel 3.25x6x2.047x1.187         |
| S9817      | 083179       | Wheel 4x2.50x2.047x0.59          |
| S9818      | 310221       | Wheel 4x1.92x1.781x.84           |
| S9819      | 310186       | Wheel 4x2.37x1.938x0.96          |
| S9841      | 071894       | Wheel 4 Poly                     |
| S9842      | 310181       | Wheel 4x2.88x2.44x0.832          |
| S9843      | 071894       | Wheel 4 Poly                     |
| S9850      | 310104       | Wheel 5x2.62x2.834x0.77          |
| S9854      | 310102       | Wheel 5x3.62x2.834x0.76          |
| S9862      | 310154       | Wheel 6x3.94x2.872x1.224         |
| S9870      | 310155       | Wheel 7x2.5x2.326xNon Typical    |
| S9880      | 310148       | Wheel 8x1.90x1.98x0.81           |
| X29050-00  | 082443       | Wheel 2.50x2.06x1.187            |

| OE Number    | Crown Number | Description                      |
|--------------|--------------|----------------------------------|
| X301738-00   | 310020       | Tire Poly 10.5x5x6.5             |
| XP20262-02X  | 310020       | Tire Poly 10.5x5x6.5             |
| Raymond (RA) |              |                                  |
| 101          | 310162       | Wheel 3.38x2.25x1.85x0.551       |
| 115          | 310178       | Wheel 3.25x5.91x2.047x1.18       |
| 116          | 310078       | Wheel 3.25x2.88x2.047x0.59       |
| 201          | 310099       | Wheel 4x2.75x2.047x0.59          |
| 202          | 310164       | Wheel 5x2.88x2.047x0.59          |
| 204          | 310159       | Wheel 5x2x2.047x0.59             |
| 206          | 310160       | Wheel 5x3.63x2.44x0.668          |
| 208          | 310158       | Wheel 4x3.62x2.047x0.59          |
| 210          | 310176       | Wheel 4x2x2.44xNon Typical       |
| 303          | 310112       | Wheel 3.38x2.63x2.047x1.137      |
| 307          | 310165       | Wheel 6x2x2.835xNon Typical      |
| 314          | 310161       | Wheel 6x2.5x2.327x1.967          |
| 317          | 310166       | Wheel 6x2.5x1.938x0.937          |
| 318          | 310167       | Wheel 6x3x2.44x0.68              |
| 319          | 310169       | Wheel 6x4x2.835x0.668            |
| 321          | 310163       | Wheel 6.88x2x2.835x0.97          |
| 325          | 310172       | Wheel 6x3.63x2.44x0.668          |
| 326          | 310177       | Wheel 6x3x2.047x0.67             |
| 327          | 310179       | Wheel 8x4x2.44x0.656             |
| 338          | 310101       | Wheel 3.38x2.63x1.979x1.242      |
| 341          | 310103       | Wheel 4x2.63x2.44x0.77           |
| 535          | 310141       | Wheel 3.25x3x2.047x0.812         |
| 623          | 310220       | Wheel 3.25x1.75x1.850x.551       |
| 629          | 154840       | Wheel 3.25x2x2.047x0.59          |
| 630          | 310162       | Wheel 3.38x2.25x1.85x0.551       |
| 631          | 310156       | Wheel 3.25x2.25x1.85x0.551       |
| 632          | 310176       | Wheel 4x2x2.44xNon Typical       |
| 633          | 310157       | Wheel 3.25x2.88x1.85x0.551       |
| 635          | 310144       | Wheel 3.25x6x2.047x0.812         |
| 636          | 310078       | Wheel 3.25x2.88x2.047x0.59       |
| 638          | 310219       | Wheel 3.25x4.2x2.047x.590        |
| 641          | 073961       | Wheel 4x2.88x2.047x0.59          |
| 644          | 310221       | Wheel 4x1.92x1.781x.84           |
| 645          | 310158       | Wheel 4x3.62x2.047x0.59          |
| 647          | 310094       | Wheel 4x2x1.575x0.575            |
| 648          | 310099       | Wheel 4x2.75x2.047x0.59          |
| 650          | 310159       | Wheel 5x2x2.047x0.59             |
| 651          | 310173       | Wheel 5x2x2.44xNon Typical       |
| 653          | 310164       | Wheel 5x2.88x2.047x0.59          |
| 654          | 310160       | Wheel 5x3.63x2.44x0.668          |
| 656          | 310168       | Wheel 5x1.12x2.047xNon Typical   |
| 660          | 310165       | Wheel 6x2x2.835xNon Typical      |
| 663          | 310161       | Wheel 6x2.5x2.327x1.967          |
| 664          | 310167       | Wheel 6x3x2.44x0.68              |
| 666          | 310169       | Wheel 6x4x2.835x0.668            |
| 667          | 310166       | Wheel 6x2.5x1.938x0.937          |
| 671          | 310163       | Wheel 6.88x2x2.835x0.97          |
| 673          | 310172       | Wheel 6x3.63x2.44x0.668          |
| 684          | 310179       | Wheel 8x4x2.44x0.656             |
| 699          | 310177       | Wheel 6x3x2.047x0.67             |
| 700          | 310178       | Wheel 3.25x5.91x2.047x1.18       |
| 7711         | 310180       | Wheel 3.25x4.2x2.047x1.18        |
| 9111         | 082021       | Wheel 6x2.75x3.149x0.83          |
| 9117         | 082020       | Wheel 6x4.25x3.149x0.83          |
| 9119         | 310131       | Wheel 8.5x2.66x2.754xNon Typical |
| 9136         | 100462       | Wheel 3.25x6.5x2.047x1.44        |
| 9143         | 083179       | Wheel 4x2.50x2.047x0.59          |
| 9151         | 083587       | Wheel 5x4.12x3.149x0.98          |
| 9433         | 310189       | Wheel 3x3.5x1.85x0.56            |
| 9534         | 310174       | Wheel 3.25x4x1.85x0.551          |
| 9811         | 077086       | Wheel 3.25x5x2.047x0.59          |
| 224382       | 083179       | Wheel 4x2.50x2.047x0.59          |
| 226864       | 310175       | Wheel 3.25x5.91x2.047x0.590      |
| 226864       | 310178       | Wheel 3.25x5.91x2.047x1.18       |
| 237271       | 073961       | Wheel 4x2.88x2.047x0.59          |

Raymond Continued ▶

**Note:** You need to add the compound part number to the wheel base number listed above. See compounds listed on page 11.03 for the dash number. Complete part number format is XXXXXX-XXX.

# Wheel & Tire Cross References by Manufacturer

Continued ▶

Raymond Continued

| OE Number       | Crown Number | Description                    |
|-----------------|--------------|--------------------------------|
| 309882-X01      | 310108       | Wheel 4x1.88x2.44x0.75         |
| 310272          | 310272       | Tire Poly 14.75x6.5x10.75      |
| 630051          | 310128       | Wheel Poly 4x2.88x1.85x0.575   |
| 632139          | 310271       | Tire Poly 14x8x10.25           |
| 632145          | 310463       | Tire Poly 15x6.5x10.75         |
| 632163          | 310293       | Tire Poly 9x7x6.25             |
| 939353          | 310244       | Wheel 3.25x4.5x2.047x.594      |
| 1002754         | 310225       | Wheel 6x3x1.9687               |
| 632069107       | 310178       | Wheel 3.25x5.91x2.047x1.18     |
| 632087003       | 310008       | Tire Poly 10x3.5x8             |
| 632126107       | 310046       | Tire Poly 14x6x11.25           |
| 632145015       | 310463       | Tire Poly 15x6.5x10.75         |
| 6632052107      | 310160       | Wheel 5x3.63x2.44x0.668        |
| 015-114-007-561 | 310220       | Wheel 3.25x1.75x1.850x.551     |
| 031-043-310     | 073961       | Wheel 4x2.88x2.047x0.59        |
| 061-053-310     | 073961       | Wheel 4x2.88x2.047x0.59        |
| 114-007-561     | 310220       | Wheel 3.25x1.75x1.850x.551     |
| 15-201          | 073961       | Wheel 4x2.88x2.047x0.59        |
| 23041-00        | 077086       | Wheel 3.25x5x2.047x0.59        |
| 312636-000      | 310316       | Wheel 3.25x4.5x2.047x.594      |
| 312728-000      | 310115       | Wheel 5x3x2.834x0.74           |
| 313687-001      | 310102       | Wheel 5x3.62x2.834x0.76        |
| 313716-001      | 077086       | Wheel 3.25x5x2.047x0.59        |
| 313717-000      | 310147       | Wheel 3.25x6x2.047x1.187       |
| 313717-001      | 310147       | Wheel 3.25x6x2.047x1.187       |
| 313718-000      | 310085       | Wheel 3.25x6x2.047x0.585       |
| 313721-001      | 083179       | Wheel 4x2.50x2.047x0.59        |
| 313723-000      | 310235       | Wheel 4x2.88x2.44x0.672        |
| 313724-000      | 310154       | Wheel 6x3.94x2.872x1.224       |
| 314322-000      | 100462       | Wheel 3.25x6.5x2.047x1.44      |
| 314325-000      | 310160       | Wheel 5x3.63x2.44x0.668        |
| 314364-000      | 310244       | Wheel 3.25x4.5x2.047x.594      |
| 314365-000      | 310244       | Wheel 3.25x4.5x2.047x.594      |
| 314366-000      | 310244       | Wheel 3.25x4.5x2.047x.594      |
| 314376-000      | 310210       | Wheel 3.25x5.5x1.98x0.69       |
| 630-030         | 073961       | Wheel 4x2.88x2.047x0.59        |
| 630-050         | 073961       | Wheel 4x2.88x2.047x0.59        |
| 630-051         | 310128       | Wheel Poly 4x2.88x1.85x0.575   |
| 630-229         | 310011       | Tire Poly 10x4.75x6.5 Contour  |
| 630-229/002     | 350005       | Rubber 10x4.75x6.5 SM NM       |
| 630-235         | 107933       | Tire Poly 10x5x6.5 Contour     |
| 630-248         | 077050       | Tire Poly 13.5x5.5x8 Contour   |
| 630-255         | 310065       | Tire Poly 16.25x6x11.25        |
| 630-259         | 310065       | Tire Poly 16.25x6x11.25        |
| 631-030         | 073961       | Wheel 4x2.88x2.047x0.59        |
| 631-031         | 073961       | Wheel 4x2.88x2.047x0.59        |
| 631-051         | 310164       | Wheel 5x2.88x2.047x0.59        |
| 632/139         | 310271       | Tire Poly 14x8x10.25           |
| 632/145         | 310463       | Tire Poly 15x6.5x10.75         |
| 632-009         | 310156       | Wheel 3.25x2.25x1.85x0.551     |
| 632-010         | 310162       | Wheel 3.38x2.25x1.85x0.551     |
| 632-015         | 310144       | Wheel 3.25x6x2.047x0.812       |
| 632-016         | 077086       | Wheel 3.25x5x2.047x0.59        |
| 632-016-003     | 077086       | Wheel 3.25x5x2.047x0.59        |
| 632-016-NL7     | 077086       | Wheel 3.25x5x2.047x0.59        |
| 632-018         | 310078       | Wheel 3.25x2.88x2.047x0.59     |
| 632-018/101     | 310078       | Wheel 3.25x2.88x2.047x0.59     |
| 632-019         | 310157       | Wheel 3.25x2.88x1.85x0.551     |
| 632-026         | 310176       | Wheel 4x2x2.44xNon Typical     |
| 632-030         | 073961       | Wheel 4x2.88x2.047x0.59        |
| 632-031         | 073961       | Wheel 4x2.88x2.047x0.59        |
| 632-031/669     | 310103       | Wheel 4x2.63x2.44x0.77         |
| 632-031-001     | 073961       | Wheel 4x2.88x2.047x0.59        |
| 632-031-003     | 073961       | Wheel 4x2.88x2.047x0.59        |
| 632-031-008     | 073961       | Wheel 4x2.88x2.047x0.59        |
| 632-031-01      | 073961       | Wheel 4x2.88x2.047x0.59        |
| 632-032         | 310158       | Wheel 4x3.62x2.047x0.59        |
| 632-032/101     | 310158       | Wheel 4x3.62x2.047x0.59        |
| 632-041/101     | 310168       | Wheel 5x1.12x2.047xNon Typical |
| 632-042         | 310159       | Wheel 5x2x2.047x0.59           |

| OE Number    | Crown Number | Description                    |
|--------------|--------------|--------------------------------|
| 632-042/101  | 310159       | Wheel 5x2x2.047x0.59           |
| 632-043      | 310164       | Wheel 5x2.88x2.047x0.59        |
| 632-045      | 310173       | Wheel 5x2x2.44xNon Typical     |
| 632-050      | 310164       | Wheel 5x2.88x2.047x0.59        |
| 632-052      | 310160       | Wheel 5x3.63x2.44x0.668        |
| 632-053      | 310161       | Wheel 6x2.5x2.327x1.967        |
| 632-057      | 310169       | Wheel 6x4x2.835x0.668          |
| 632-058      | 310165       | Wheel 6x2x2.835xNon Typical    |
| 632-061      | 310177       | Wheel 6x3x2.047x0.67           |
| 632-061-007  | 310177       | Wheel 6x3x2.047x0.67           |
| 632-062      | 310167       | Wheel 6x3x2.44x0.68            |
| 632-064      | 310166       | Wheel 6x2.5x1.938x0.937        |
| 632-066      | 310163       | Wheel 6.88x2x2.835x0.97        |
| 632-069      | 310178       | Wheel 3.25x5.91x2.047x1.18     |
| 632-071      | 310180       | Wheel 3.25x4.2x2.047x1.18      |
| 632-072      | 310219       | Wheel 3.25x4.2x2.047x.590      |
| 632-076      | 154840       | Wheel 3.25x2x2.047x0.59        |
| 632-078      | 310179       | Wheel 8x4x2.44x0.656           |
| 632-081      | 310005       | Tire Poly 9x3.5x6.5            |
| 632-085      | 107933       | Tire Poly 10x5x6.5 Contour     |
| 632-087      | 310008       | Tire Poly 10x3.5x8             |
| 632-090      | 107933       | Tire Poly 10x5x6.5 Contour     |
| 632-090/03   | 310202       | Tire Poly 10x5x6.5 w/Bevel     |
| 632-090/SPCL | 310202       | Tire Poly 10x5x6.5 w/Bevel     |
| 632-090-03   | 310012       | Tire Poly 10x5x6.5             |
| 632-090-SPCL | 310202       | Tire Poly 10x5x6.5 w/Bevel     |
| 632-091      | 310011       | Tire Poly 10x4.75x6.5 Contour  |
| 632-094      | 310017       | Tire Poly 10.5x3.5x8           |
| 632-095      | 310020       | Tire Poly 10.5x5x6.5           |
| 632-096      | 310018       | Tire Poly 10.5x4.5x8           |
| 632-098      | 310023       | Tire Poly 10.5x6.5x8           |
| 632-099      | 310015       | Tire Poly 10x7x6.25            |
| 632-101      | 310020       | Tire Poly 10.5x5x6.5 Sipe w CG |
| 632-101/BA   | 310020       | Tire Poly 10.5x5x6.5           |
| 632-102      | 310016       | Tire Poly 10x7x8               |
| 632-104      | 310029       | Tire Poly 12x5x9               |
| 632-106      | 310013       | Tire Poly 10x6x6.25            |
| 632-108      | 310034       | Tire Poly 13x6x10.5            |
| 632-112      | 077050       | Tire Poly 13.5x5.5x8 Contour   |
| 632-114      | 310055       | Tire Poly 15x7x11.25           |
| 632-115      | 310056       | Tire Poly 15x8x11.125 G        |
| 632-119      | 310066       | Tire Poly 16.25x7x11.25        |
| 632-120      | 310065       | Tire Poly 16.25x6x11.25        |
| 632-121      | 310052       | Tire Poly 15x6x11.25           |
| 632-122      | 310056       | Tire Poly 15x8x11.125 G        |
| 632-123      | 310066       | Tire Poly 16.25x7x11.25        |
| 632-125      | 310044       | Tire Poly 14x5x11.25           |
| 632-126      | 310046       | Tire Poly 14x6x11.25           |
| 632-126/962  | 310046       | Tire Poly 14x6x11.25           |
| 632-129      | 310047       | Tire Poly 14x8x11.25           |
| 632-131      | 310037       | Tire Poly 13.5x6x10.5          |
| 632-132      | 310054       | Tire Poly 15x6x11.75           |
| 632-133      | 079266       | Tire Poly 13x5.5x8             |
| 632-134-CR1  | 079494       | Tire Poly 13x4.5x8             |
| 632-135      | 310027       | Tire Poly 12x5x8               |
| 632-139      | 310271       | Tire Poly 14x8x10.25           |
| 632-141      | 310065       | Tire Poly 16.25x6x11.25        |
| 632-145      | 310463       | Tire Poly 15x6.5x10.75         |
| 632-145/015  | 310463       | Tire Poly 15x6.5x10.75         |
| 632-146      | 310005       | Tire Poly 9x3.5x6.5            |
| 632-147      | 310011       | Tire Poly 10x4.75x6.5 Contour  |
| 632-151      | 310463       | Tire Poly 15x6.5x10.75         |
| 632-153      | 310054       | Tire Poly 15x6x11.75           |
| 632-154      | 310047       | Tire Poly 14x8x11.25           |
| 632-156      | 310172       | Wheel 6x3.63x2.44x0.668        |
| 632-157      | 310175       | Wheel 3.25x5.91x2.047x0.590    |
| 632-159      | 310066       | Tire Poly 16.25x7x11.25        |
| 632-161      | 310064       | Tire Poly 16.25x5x11.25        |
| 632-161/CA   | 310064       | Tire Poly 16.25x5x11.25        |
| 632-163      | 310293       | Tire Poly 9x7x6.25             |

**WHEELS AND TIRES**

**Note:** You need to add the compound part number to the wheel base number listed above.  
See compounds listed on page 11.03 for the dash number. Complete part number format is XXXXXX-XXX.

Raymond Continued ▶

# Wheel & Tire Cross References by Manufacturer

Continued ▶

Raymond Continued

| OE Number      | Crown Number | Description                      |
|----------------|--------------|----------------------------------|
| 632-163/015    | 310293       | Tire Poly 9x7x6.25               |
| 632-163-015    | 310293       | Tire Poly 9x7x6.25               |
| 632-165        | 310220       | Wheel 3.25x1.75x1.850x.551       |
| 632-168        | 310011       | Tire Poly 10x4.75x6.5 Contour    |
| 632-169        | 310011       | Tire Poly 10x4.75x6.5 Contour    |
| 632-170        | 310011       | Tire Poly 10x4.75x6.5 Contour    |
| 632-171        | 310011       | Tire Poly 10x4.75x6.5 Contour    |
| 632-204        | 077084       | Wheel 3.25x3.25x2.047x0.59       |
| 632-204/CR1    | 077084       | Wheel 3.25x3.25x2.047x0.59       |
| 632-241        | 083179       | Wheel 4x2.50x2.047x0.59          |
| 632-258        | 310101       | Wheel 3.38x2.63x1.979x1.242      |
| 632-258-CL1    | 310101       | Wheel 3.38x2.63x1.979x1.242      |
| 632-278        | 075999       | Wheel                            |
| 632-314        | 310141       | Wheel 3.25x3x2.047x0.812         |
| 632-314        | 310174       | Wheel 3.25x4x1.85x0.551          |
| 632-314/BA     | 310141       | Wheel 3.25x3x2.047x0.812         |
| 632-314/MT     | 310174       | Wheel 3.25x4x1.85x0.551          |
| 632-314MT      | 310174       | Wheel 3.25x4x1.85x0.551          |
| 632-321        | 100462       | Wheel 3.25x6.5x2.047x1.44        |
| 632-321/CR     | 100462       | Wheel 3.25x6.5x2.047x1.44        |
| 632-322        | 310112       | Wheel 3.38x2.63x2.047x1.137      |
| 632-322/CL1    | 310112       | Wheel 3.38x2.63x2.047x1.137      |
| 632-41         | 082020       | Wheel 6x4.25x3.149x0.83          |
| 632-414        | 082020       | Wheel 6x4.25x3.149x0.83          |
| 632-421        | 083179       | Wheel 4x2.50x2.047x0.59          |
| 632-421/CR     | 083179       | Wheel 4x2.50x2.047x0.59          |
| 632421CR1      | 083179       | Wheel 4x2.50x2.047x0.59          |
| 632-421-CR7    | 083179       | Wheel 4x2.50x2.047x0.59          |
| 632-541        | 083587       | Wheel 5x4.12x3.149x0.98          |
| 632-541/CR     | 083587       | Wheel 5x4.12x3.149x0.98          |
| 632-623        | 082021       | Wheel 6x2.75x3.149x0.83          |
| 632-623/CR1    | 082021       | Wheel 6x2.75x3.149x0.83          |
| 632-637        | 310171       | Wheel 6x3x1.781x0.81             |
| 632-812        | 132359       | Wheel Caster                     |
| 632-812        | 310131       | Wheel 8.5x2.66x2.754xNon Typical |
| 632-955/CR1    | 310208       | Tire Poly 9x5x5 Smooth Step      |
| 632-955-CR1    | 077848       | Tire Poly 9x5x5                  |
| 640-051        | 073961       | Wheel 4x2.88x2.047x0.59          |
| 640-070        | 310164       | Wheel 5x2.88x2.047x0.59          |
| 671-013        | 083179       | Wheel 4x2.50x2.047x0.59          |
| 671-015-21     | 083179       | Wheel 4x2.50x2.047x0.59          |
| 671-024        | 310221       | Wheel 4x1.92x1.781x.84           |
| 671-024/25     | 310221       | Wheel 4x1.92x1.781x.84           |
| 671-026/020    | 310094       | Wheel 4x2x1.575x0.575            |
| 671-026-20     | 310094       | Wheel 4x2x1.575x0.575            |
| 671-041        | 310189       | Wheel 3x3.5x1.85x0.56            |
| 671-041-07     | 310189       | Wheel 3x3.5x1.85x0.56            |
| 671-053        | 310166       | Wheel 6x2.5x1.938x0.937          |
| 671-421        | 083179       | Wheel 4x2.50x2.047x0.59          |
| 921-000-370    | 310175       | Wheel 3.25x5.91x2.047x0.590      |
| 928-603        | 310164       | Wheel 5x2.88x2.047x0.59          |
| 939-353-251    | 310244       | Wheel 3.25x4.5x2.047x.594        |
| 950-WHL/CENTER | 310250       | Wheel 3.25x1.88x2.047x0.595 I    |
| 950-WHL/ KIT   | 310250       | Wheel Kit 3.25x1.88x2.047x0.595  |
| 950-WHL/ OUTER | 310250       | Wheel 3.25x1.88x2.047x0.595 O    |
| D524334        | 310005       | Tire Poly 9x3.5x6.5              |
| M0203          | 073961       | Wheel 4x2.88x2.047x0.59          |
| RADS226864     | 310175       | Wheel 3.25x5.91x2.047x0.590      |
| S132           | 310180       | Wheel 3.25x4.2x2.047x1.18        |
| S158           | 310034       | Tire Poly 13x6x10.5              |
| S182           | 310056       | Tire Poly 15x8x11.125 G          |
| S621           | 310219       | Wheel 3.25x4.2x2.047x.590        |
| S623           | 310220       | Wheel 3.25x1.75x1.850x.551       |
| S624           | 310165       | Wheel 6x2x2.835xNon Typical      |
| S626           | 310078       | Wheel 3.25x2.88x2.047x0.59       |
| S627           | 154840       | Wheel 3.25x2x2.047x0.59          |
| S628           | 310144       | Wheel 3.25x6x2.047x0.812         |
| S629           | 310178       | Wheel 3.25x5.91x2.047x1.18       |
| S632           | 310176       | Wheel 4x2x2.44xNon Typical       |
| S633           | 310157       | Wheel 3.25x2.88x1.85x0.551       |

| OE Number           | Crown Number | Description                    |
|---------------------|--------------|--------------------------------|
| S635                | 310144       | Wheel 3.25x6x2.047x0.812       |
| S636                | 077086       | Wheel 3.25x5x2.047x0.59        |
| S640                | 310221       | Wheel 4x1.92x1.781x.84         |
| S645                | 310158       | Wheel 4x3.62x2.047x0.59        |
| S647                | 310099       | Wheel 4x2.75x2.047x0.59        |
| S648                | 310094       | Wheel 4x2x1.575x0.575          |
| S650                | 310159       | Wheel 5x2x2.047x0.59           |
| S651                | 310173       | Wheel 5x2x2.44xNon Typical     |
| S653                | 310164       | Wheel 5x2.88x2.047x0.59        |
| S654                | 310160       | Wheel 5x3.63x2.44x0.668        |
| S656                | 310168       | Wheel 5x1.12x2.047xNon Typical |
| S663                | 310161       | Wheel 6x2.5x2.327x1.967        |
| S664                | 310167       | Wheel 6x3x2.44x0.68            |
| S666                | 310169       | Wheel 6x4x2.835x0.668          |
| S667                | 310166       | Wheel 6x2.5x1.938x0.937        |
| S671                | 310163       | Wheel 6.88x2x2.835x0.97        |
| S673                | 310172       | Wheel 6x3.63x2.44x0.668        |
| S674                | 310172       | Wheel 6x3.63x2.44x0.668        |
| S675                | 310177       | Wheel 6x3x2.047x0.67           |
| S684                | 310179       | Wheel 8x4x2.44x0.656           |
| S699                | 310177       | Wheel 6x3x2.047x0.67           |
| S700                | 310178       | Wheel 3.25x5.91x2.047x1.18     |
| <b>Ro-Lift (RL)</b> |              |                                |
| 101                 | 310188       | Wheel 3.25x3.75x1.75xThru      |
| 9330                | 310188       | Wheel 3.25x3.75x1.75xThru      |
| 9380                | 310089       | Wheel 8x2x1.75xThru            |
| 913393              | 310089       | Wheel 8x2x1.75xThru            |
| 3-91002             | 310089       | Wheel 8x2x1.75xThru            |
| 3-91023             | 310188       | Wheel 3.25x3.75x1.75xThru      |
| R0301               | 310089       | Wheel 8x2x1.75xThru            |
| S9330               | 310188       | Wheel 3.25x3.75x1.75xThru      |
| S9380               | 310089       | Wheel 8x2x1.75xThru            |
| T-23-A              | 310089       | Wheel 8x2x1.75xThru            |
| T-42A               | 310188       | Wheel 3.25x3.75x1.75xThru      |
| <b>Schreck (SC)</b> |              |                                |
| 41-27083            | 073961       | Wheel 4x2.88x2.047x0.59        |
| <b>Still (SL)</b>   |              |                                |
| 5402294             | 082285       | Wheel (Nylon)                  |
| <b>Toyota (TY)</b>  |              |                                |
| 636                 | 310078       | Wheel 3.25x2.88x2.047x0.59     |
| 700                 | 310178       | Wheel 3.25x5.91x2.047x1.18     |
| 9143                | 083179       | Wheel 4x2.50x2.047x0.59        |
| 9811                | 077086       | Wheel 3.25x5x2.047x0.59        |
| 310225              | 310225       | Wheel 6x3x1.9687               |
| 5900281871          | 310172       | Wheel 6x3.63x2.44x0.668        |
| 00590-00013-71      | 310178       | Wheel 3.25x5.91x2.047x1.18     |
| 00590-00023-71      | 310178       | Wheel 3.25x5.91x2.047x1.18     |
| 00590-00025-71      | 310178       | Wheel 3.25x5.91x2.047x1.18     |
| 00590-00506-71      | 310078       | Wheel 3.25x2.88x2.047x0.59     |
| 00590-00773-71      | 077086       | Wheel 3.25x5x2.047x0.59        |
| 00590-00777-71      | 077086       | Wheel 3.25x5x2.047x0.59        |
| 00590-00779-71      | 077086       | Wheel 3.25x5x2.047x0.59        |
| 00590-02818-71      | 310172       | Wheel 6x3.63x2.44x0.668        |
| 00590-04775-71      | 083179       | Wheel 4x2.50x2.047x0.59        |
| 00590-04780-71      | 083179       | Wheel 4x2.50x2.047x0.59        |
| 00590-05044-71      | 310102       | Wheel 5x3.62x2.834x0.76        |
| 00590-05047-71      | 310235       | Wheel 4x2.88x2.44x0.672        |
| 00590-40028-71      | 310053       | Tire Poly 13.5x5.5x10          |
| 00590-40031-71      | 310053       | Tire Poly 13.5x5.5x10          |
| 00590-41747-71      | 310225       | Wheel 6x3x1.9687               |
| 00590-41998-71      | 310225       | Wheel 6x3x1.9687               |
| 00590-42111-71      | 310178       | Wheel 3.25x5.91x2.047x1.18     |
| 00590-43383-71      | 310244       | Wheel 3.25x4.5x2.047x.594      |
| 00590-46419-71      | 310244       | Wheel 3.25x4.5x2.047x.594      |
| 00590-46420-71      | 310244       | Wheel 3.25x4.5x2.047x.594      |
| 00590-46421-71      | 310244       | Wheel 3.25x4.5x2.047x.594      |
| 00591-04635-81      | 071665       | Wheel Polyurethane             |
| 00591-04638-81      | 071894       | Wheel 4 Poly                   |
| 00591-04647-81      | 073602       | Wheel 5 Steel Assm             |
| 00591-04828-81      | 080915       | Wheel 8x3.75x3.15x0.83         |

Toyota Continued ▶

**Note:** You need to add the compound part number to the wheel base number listed above.  
See compounds listed on page 11.03 for the dash number. Complete part number format is XXXXX-XXX.

WHEELS AND TIRES

# Wheel & Tire Cross References by Manufacturer

Continued ▶

Toyota Continued

| OE Number      | Crown Number | Description                      |
|----------------|--------------|----------------------------------|
| 00591-04838-81 | 081645       | Wheel Poly                       |
| 00591-04841-81 | 082020       | Wheel 6x4.25x3.149x0.83          |
| 00591-04842-81 | 082021       | Wheel 6x2.75x3.149x0.83          |
| 00591-04848-81 | 083879       | Roller Load                      |
| 00591-04849-81 | 083879       | Roller Load                      |
| 00591-04852-81 | 082443       | Wheel 2.50x2.06x1.187            |
| 00591-04885-81 | 083585       | Wheel 4x2.88x2.047x0.75          |
| 00591-04886-81 | 083586       | Wheel 5x2.88x3.149x0.98          |
| 00591-04887-81 | 083587       | Wheel 5x4.12x3.149x0.98          |
| 00591-04897-81 | 083834       | Wheel                            |
| 00591-05016-81 | 310131       | Wheel 8.5x2.66x2.754xNon Typical |
| 00591-10209-81 | 310249       | Wheel 5.5x5x2.5                  |
| 00591-10318-81 | 073602       | Wheel 5 Steel Assm               |
| 00591-10322-81 | 075999       | Wheel                            |
| 00591-10325-81 | 077084       | Load Wheel Assm 3.25x3.25        |
| 00591-10326-81 | 125069       | Wheel 6x2.88x3.15x0.80           |
| 00591-10330-81 | 311520       | Wheel 10x3 Caster                |
| 00591-10332-81 | 077084       | Load Wheel Assm 3.25x3.25        |
| 00591-10341-81 | 083585       | Wheel 4x2.88x2.047x0.75          |
| 00591-10342-81 | 088628       | Wheel 4x4.12x2.047x0.75          |
| 00591-10343-81 | 088628       | Wheel 4x4.12x2.047x0.75          |
| 00591-10362-81 | 077086       | Wheel 3.25x5x2.047x0.59          |
| 00591-20043-81 | 044506-101   | Roller Poly Assm                 |
| 00591-21783-81 | 044507       | Roller Poly                      |
| 00591-21851-81 | 107933       | Tire Poly 10x5x6.5 Contour       |
| 00591-25893-81 | 310108       | Wheel 4x1.88x2.44x0.75           |
| 00591-26006-81 | 310093       | Wheel 3.25x6.5x1.98x1.177        |
| 00591-26068-81 | 072718       | Wheel Assm Poly                  |
| 00591-26070-81 | 071892       | Wheel 5 dia                      |
| 00591-26079-81 | 115032       | Wheel 5x2.88x2.44x0.83           |
| 00591-26080-81 | 115032       | Wheel 5x2.88x2.44x0.83           |
| 00591-26085-81 | 083167       | Wheel Rubber Assm                |
| 00591-30917-81 | 310093       | Wheel 3.25x6.5x1.98x1.177        |
| 00591-31561-81 | 082274       | Wheel Assm                       |
| 00591-31569-81 | 082283       | Wheel Assm (Poly)                |
| 00591-31841-81 | 073961       | Wheel 4x2.88x2.047x0.59          |
| 00591-31851-81 | 071894       | Wheel 4 Poly                     |
| 00591-31852-81 | 073602       | Wheel 5 Steel Assm               |
| 00591-31853-81 | 075999       | Wheel                            |
| 00591-31854-81 | 082021       | Wheel 6x2.75x3.149x0.83          |
| 00591-31855-81 | 310131       | Wheel 8.5x2.66x2.754xNon Typical |
| 00591-31856-81 | 083879       | Roller Load                      |
| 00591-31858-81 | 077086       | Wheel 3.25x5x2.047x0.59          |
| 00591-31859-81 | 100462       | Wheel 3.25x6.5x2.047x1.44        |
| 00591-31861-81 | 083179       | Wheel 4x2.50x2.047x0.59          |
| 00591-31862-81 | 081645       | Wheel Poly                       |
| 00591-31863-81 | 083585       | Wheel 4x2.88x2.047x0.75          |
| 00591-31864-81 | 083587       | Wheel 5x4.12x3.149x0.98          |
| 00591-31865-81 | 083586       | Wheel 5x2.88x3.149x0.98          |
| 00591-31866-81 | 041269       | Wheel Poly                       |
| 00591-31874-81 | 083179       | Wheel 4x2.50x2.047x0.59          |
| 00591-36575-81 | 077086       | Wheel 3.25x5x2.047x0.59          |
| 00591-37817-81 | 082742       | Wheel Steel                      |
| 00591-39562-81 | 082285       | Wheel (Nylon)                    |
| 00591-39612-81 | 044508       | Roller Nylon                     |
| 00591-39613-81 | 044506-102   | Roller Nylon Assm                |
| 00591-39618-81 | 044506-101   | Roller Poly Assm                 |
| 00591-39626-81 | 044507       | Roller Poly                      |
| 00591-39628-81 | 044495       | Wheel Assm Poly                  |
| 00591-40742-81 | 072718       | Wheel Assm Poly                  |
| 00591-40744-81 | 071892       | Wheel 5 dia                      |
| 00591-40745-81 | 071665       | Wheel Polyurethane               |
| 00591-40746-81 | 082443       | Wheel 2.50x2.06x1.187            |
| 00591-40747-81 | 080915       | Wheel 8x3.75x3.15x0.83           |
| 00591-40748-81 | 082020       | Wheel 6x4.25x3.149x0.83          |
| 00591-40752-81 | 088628       | Wheel 4x4.12x2.047x0.75          |
| 00591-40753-81 | 083167       | Wheel Rubber Assm                |
| 00591-40771-81 | 073961       | Wheel 4x2.88x2.047x0.59          |
| 00591-43114-81 | 044506-101   | Roller Poly Assm                 |
| 00591-43136-81 | 044495       | Wheel Assm Poly                  |

| OE Number        | Crown Number | Description                      |
|------------------|--------------|----------------------------------|
| 00591-43153-81   | 082285       | Wheel (Nylon)                    |
| 00591-43213-81   | 044506-102   | Roller Nylon Assm                |
| 00591-43276-81   | 044508       | Roller Nylon                     |
| 00591-44880-81   | 044507       | Roller Poly                      |
| 00591-44881-81   | 115032       | Wheel 5x2.88x2.44x0.83           |
| 00591-44882-81   | 115033       | Wheel 5x4.12x2.44x0.83           |
| 00591-52026-81   | 082443       | Wheel 2.50x2.06x1.187            |
| 00591-52028-81   | 075999       | Wheel                            |
| 00591-52035-81   | 077086       | Wheel 3.25x5x2.047x0.59          |
| 00591-52037-81   | 083879       | Roller Load                      |
| 00591-52038-81   | 071665       | Wheel Polyurethane               |
| 00591-52040-81   | 077086       | Wheel 3.25x5x2.047x0.59          |
| 00591-52046-81   | 100462       | Wheel 3.25x6.5x2.047x1.44        |
| 00591-52050-81   | 081645       | Wheel Poly                       |
| 00591-52052-81   | 071894       | Wheel 4 Poly                     |
| 00591-52053-81   | 083179       | Wheel 4x2.50x2.047x0.59          |
| 00591-52059-81   | 071892       | Wheel 5 dia                      |
| 00591-52062-81   | 083586       | Wheel 5x2.88x3.149x0.98          |
| 00591-52068-81   | 083587       | Wheel 5x4.12x3.149x0.98          |
| 00591-52072-81   | 082021       | Wheel 6x2.75x3.149x0.83          |
| 00591-52080-81   | 082020       | Wheel 6x4.25x3.149x0.83          |
| 00591-52089-81   | 080915       | Wheel 8x3.75x3.15x0.83           |
| 00591-52093-81   | 041269       | Wheel Poly                       |
| 00591-52099-81   | 083879       | Roller Load                      |
| 00591-52108-81   | 073961       | Wheel 4x2.88x2.047x0.59          |
| 00591-52115-81   | 310131       | Wheel 8.5x2.66x2.754xNon Typical |
| 00591-52125-81   | 107933       | Tire Poly 10x5x6.5 Contour       |
| 00591-52540-81   | 082274       | Wheel Assm                       |
| 00591-57656-81   | 044508       | Roller Nylon                     |
| 00591-57662-81   | 044506-101   | Roller Poly Assm                 |
| 00591-57673-81   | 044506-102   | Roller Nylon Assm                |
| 00591-57678-81   | 044507       | Roller Poly                      |
| 00591-57680-81   | 044495       | Wheel Assm Poly                  |
| 00591-57793-81   | 072718       | Wheel Assm Poly                  |
| 00591-57811-81   | 077086       | Wheel 3.25x5x2.047x0.59          |
| 00591-57827-81   | 088628       | Wheel 4x4.12x2.047x0.75          |
| 00591-57829-81   | 073602       | Wheel 5 Steel Assm               |
| 00591-57861-81   | 310179       | Wheel 8x4x2.44x0.656             |
| 00591-57865-81   | 310093       | Wheel 3.25x6.5x1.98x1.177        |
| 00591-57886-81   | 077086       | Wheel 3.25x5x2.047x0.59          |
| 00591-57903-81   | 083167       | Wheel Rubber Assm                |
| 00591-62172-81   | 310275       | Caster Assembly FS STR4001       |
| 00591-71713-81   | 082021       | Load Wheel Assm 6x2.75           |
| 00591-73835-81   | 123603       | Load Wheel Assm 3.25 x 4.50      |
| 00591-74086-81   | 077084       | Load Wheel Assm 3.25x3.25        |
| 590-00025-71     | 310178       | Wheel 3.25x5.91x2.047x1.18       |
| 590-001086-71    | 310011       | Tire Poly 10x4.75x6.5 Contour    |
| 590-04-006-71    | 310053       | Tire Poly 13.5x5.5x10            |
| 590-04-148-71    | 310053       | Tire Poly 13.5x5.5x10            |
| S353             | 310102       | Wheel 5x3.62x2.834x0.76          |
| S700             | 310178       | Wheel 3.25x5.91x2.047x1.18       |
| S9143            | 083179       | Wheel 4x2.50x2.047x0.59          |
| <b>Yale (YT)</b> |              |                                  |
| 108              | 310174       | Wheel 3.25x4x1.85x0.551          |
| 117              | 310185       | Wheel 3.25x4.5x1.575x0.56        |
| 118              | 310170       | Wheel 3.38x2.75x2.047x0.91       |
| 118              | 310184       | Wheel 3.38x2.75x2.047x0.605      |
| 121              | 154840       | Wheel 3.25x2x2.047x0.59          |
| 129              | 310187       | Wheel 3.25x5.75x2.44x0.69        |
| 130              | 310138       | Wheel 3.25x5.75x2.047x0.825      |
| 133              | 310093       | Wheel 3.25x6.5x1.98x1.177        |
| 137              | 310184       | Wheel 3.38x2.75x2.047x0.605      |
| 138              | 154840       | Wheel 3.25x2x2.047x0.59          |
| 143              | 310183       | Wheel 4x2.75x2.44x0.843          |
| 153              | 312360       | Wheel 5x3.88x2.05x0.60           |
| 209              | 310235       | Wheel 4x2.88x2.44x0.672          |
| 210              | 310183       | Wheel 4x2.75x2.44x0.843          |
| 211              | 310186       | Wheel 4x2.37x1.938x0.96          |
| 234              | 310193       | Wheel 4x2.75x1.78x0.72           |
| 301              | 310089       | Wheel 8x2x1.75xThru              |

WHEELS AND TIRES

**Note:** You need to add the compound part number to the wheel base number listed above.  
See compounds listed on page 11.03 for the dash number. Complete part number format is XXXXXX-XXX.

Yale Continued ▶

# Wheel & Tire Cross References by Manufacturer

Continued ▶

Yale Continued

| OE Number | Crown Number | Description                       |
|-----------|--------------|-----------------------------------|
| 338       | 310101       | Wheel 3.38x2.63x1.979x1.242       |
| 354       | 310116       | Wheel 5x3.75x2.834x0.74           |
| 386       | 310091       | Wheel 7.88x2.48x2.047xNon Typical |
| 425       | 310137       | Wheel 3.25x4.28x2.047x0.825       |
| 606       | 310091       | Wheel 7.88x2.48x2.047xNon Typical |
| 641       | 073961       | Wheel 4x2.88x2.047x0.59           |
| 647       | 310094       | Wheel 4x2x1.575x0.575             |
| 653       | 310164       | Wheel 5x2.88x2.047x0.59           |
| 663       | 310161       | Wheel 6x2.5x2.327x1.967           |
| 801       | 310138       | Wheel 3.25x5.75x2.047x0.825       |
| 805       | 310185       | Wheel 3.25x4.5x1.575x0.56         |
| 806       | 310245       | Wheel 3.25x4.5x2.047x.710         |
| 815       | 310093       | Wheel 3.25x6.5x1.98x1.177         |
| 816       | 310000       | Wheel 3.25x6.5 Single Bearing     |
| 817       | 100462       | Wheel 3.25x6.5x2.047x1.44         |
| 820       | 310185       | Wheel 3.25x4.5x1.575x0.56         |
| 821       | 310187       | Wheel 3.25x5.75x2.44x0.69         |
| 824       | 310186       | Wheel 4x2.37x1.938x0.96           |
| 826       | 310103       | Wheel 4x2.63x2.44x0.77            |
| 827       | 310149       | Wheel 3.25x3x2.047x0.656          |
| 828       | 083179       | Wheel 4x2.50x2.047x0.59           |
| 828       | 310114       | Wheel 4x2.5x2.047x0.76            |
| 844       | 310235       | Wheel 4x2.88x2.44x0.672           |
| 5581      | 154840       | Wheel 3.25x2x2.047x0.59           |
| 8313      | 310116       | Wheel 5x3.75x2.834x0.74           |
| 9110      | 310078       | Wheel 3.25x2.88x2.047x0.59        |
| 9143      | 083179       | Wheel 4x2.50x2.047x0.59           |
| 9145      | 081645       | Wheel Poly                        |
| 9330      | 310188       | Wheel 3.25x3.75x1.75xThru         |
| 9380      | 310089       | Wheel 8x2x1.75xThru               |
| 9534      | 310174       | Wheel 3.25x4x1.85x0.551           |
| 11493     | 081645       | Wheel Poly                        |
| 156181    | 310093       | Wheel 3.25x6.5x1.98x1.177         |
| 188457    | 310096       | Wheel 6x2x2.44x0.625              |
| 301314    | 083585       | Wheel 4x2.88x2.047x0.75           |
| 310530    | 310078       | Wheel 3.25x2.88x2.047x0.59        |
| 325993    | 310174       | Wheel 3.25x4x1.85x0.551           |
| 560524    | 310174       | Wheel 3.25x4x1.85x0.551           |
| 569987    | 310149       | Wheel 3.25x3x2.047x0.656          |
| 569987    | 310212       | Wheel 3.25x3x2.047x.590           |
| 598215    | 310142       | Wheel 4x2.88x2.44x0.75            |
| 598215    | 310235       | Wheel 4x2.88x2.44x0.672           |
| 650546    | 310185       | Wheel 3.25x4.5x1.575x0.56         |
| 1213591   | 310170       | Wheel 3.38x2.75x2.047x0.91        |
| 1219933   | 310002       | Tire Poly 8x4x6.25                |
| 1291933   | 310002       | Tire Poly 8x4x6.25                |
| 3032897   | 310178       | Wheel 3.25x5.91x2.047x1.18        |
| 3051525   | 310093       | Wheel 3.25x6.5x1.98x1.177         |
| 3133017   | 310181       | Wheel 4x2.88x2.44x0.832           |
| 5748215   | 310142       | Wheel 4x2.88x2.44x0.75            |
| 5748215   | 310235       | Wheel 4x2.88x2.44x0.672           |
| 5800091   | 132359       | Wheel Caster                      |
| 5932569   | 310101       | Wheel 3.38x2.63x1.979x1.242       |
| 6057853   | 310184       | Wheel 3.38x2.75x2.047x0.605       |
| 65269600  | 310185       | Wheel 3.25x4.5x1.575x0.56         |
| 65269601  | 310185       | Wheel 3.25x4.5x1.575x0.56         |
| 15162900  | 310096       | Wheel 6x2x2.44x0.625              |
| 19069600  | 310096       | Wheel 6x2x2.44x0.625              |
| 25404500  | 310096       | Wheel 6x2x2.44x0.625              |
| 57482700  | 310142       | Wheel 4x2.88x2.44x0.75            |
| 57482700  | 310235       | Wheel 4x2.88x2.44x0.672           |
| 65509200  | 310185       | Wheel 3.25x4.5x1.575x0.56         |
| 120564301 | 310183       | Wheel 4x2.75x2.44x0.843           |
| 121359100 | 310170       | Wheel 3.38x2.75x2.047x0.91        |
| 129661100 | 154840       | Wheel 3.25x2x2.047x0.59           |
| 129887100 | 154840       | Wheel 3.25x2x2.047x0.59           |
| 150015306 | 310193       | Wheel 4x2.75x1.78x0.72            |
| 150015364 | 077086       | Wheel 3.25x5x2.047x0.59           |
| 150015365 | 077086       | Wheel 3.25x5x2.047x0.59           |

| OE Number | Crown Number | Description                      |
|-----------|--------------|----------------------------------|
| 150015428 | 310179       | Wheel 8x4x2.44x0.656             |
| 150015437 | 073961       | Wheel 4x2.88x2.047x0.59          |
| 150015450 | 310161       | Wheel 6x2.5x2.327x1.967          |
| 150015505 | 073961       | Wheel 4x2.88x2.047x0.59          |
| 150015527 | 072718       | Wheel Assm Poly                  |
| 150015529 | 073602       | Wheel 5 Steel Assm               |
| 150015530 | 073961       | Wheel 4x2.88x2.047x0.59          |
| 150015531 | 071892       | Wheel 5 dia                      |
| 150015533 | 071665       | Wheel Polyurethane               |
| 150015536 | 075999       | Wheel                            |
| 150015537 | 082021       | Wheel 6x2.75x3.149x0.83          |
| 150015538 | 082443       | Wheel 2.50x2.06x1.187            |
| 150015543 | 082020       | Wheel 6x4.25x3.149x0.83          |
| 150015546 | 083879       | Roller Load                      |
| 150015549 | 077086       | Wheel 3.25x5x2.047x0.59          |
| 150015550 | 100462       | Wheel 3.25x6.5x2.047x1.44        |
| 150015552 | 083879       | Roller Load                      |
| 150015554 | 071665       | Wheel Polyurethane               |
| 150015555 | 100462       | Wheel 3.25x6.5x2.047x1.44        |
| 150015556 | 081645       | Wheel Poly                       |
| 150015557 | 083179       | Wheel 4x2.50x2.047x0.59          |
| 150015558 | 081645       | Wheel Poly                       |
| 150015559 | 083585       | Wheel 4x2.88x2.047x0.75          |
| 150015562 | 083587       | Wheel 5x4.12x3.149x0.98          |
| 150015563 | 083586       | Wheel 5x2.88x3.149x0.98          |
| 150015568 | 083879       | Roller Load                      |
| 150017803 | 107933       | Tire Poly 10x5x6.5 Contour       |
| 150017805 | 107933       | Tire Poly 10x5x6.5 Contour       |
| 150102610 | 107933       | Tire Poly 10x5x6.5 Contour       |
| 150103694 | 310028       | Tire Poly 12x5.5x8               |
| 150110002 | 310002       | Tire Poly 8x4x6.25               |
| 150110132 | 310040       | Tire Poly 13.5x6.5x8             |
| 150110144 | 107933       | Tire Poly 10x5x6.5 Contour       |
| 150110192 | 077848       | Tire Poly 9x5x5                  |
| 150110322 | 107933       | Tire Poly 10x5x6.5 Contour       |
| 150110663 | 310028       | Tire Poly 12x5.5x8               |
| 150110666 | 107933       | Tire Poly 10x5x6.5 Contour       |
| 150110683 | 107933       | Tire Poly 10x5x6.5 Contour       |
| 155015398 | 310144       | Wheel 3.25x6x2.047x0.812         |
| 220002190 | 310131       | Wheel 8.5x2.66x2.754xNon Typical |
| 220007770 | 083879       | Roller Load                      |
| 220007781 | 072718       | Wheel Assm Poly                  |
| 220007782 | 073602       | Wheel 5 Steel Assm               |
| 220008327 | 073961       | Wheel 4x2.88x2.047x0.59          |
| 220008610 | 083586       | Wheel 5x2.88x3.149x0.98          |
| 220008615 | 100462       | Wheel 3.25x6.5x2.047x1.44        |
| 220008657 | 071894       | Wheel 4 Poly                     |
| 220008659 | 075999       | Wheel                            |
| 220008660 | 082021       | Wheel 6x2.75x3.149x0.83          |
| 220008661 | 082443       | Wheel 2.50x2.06x1.187            |
| 220008662 | 080915       | Wheel 8x3.75x3.15x0.83           |
| 220008663 | 082020       | Wheel 6x4.25x3.149x0.83          |
| 220008666 | 083179       | Wheel 4x2.50x2.047x0.59          |
| 220008667 | 081645       | Wheel Poly                       |
| 220008668 | 083585       | Wheel 4x2.88x2.047x0.75          |
| 220008669 | 083587       | Wheel 5x4.12x3.149x0.98          |
| 220012781 | 073961       | Wheel 4x2.88x2.047x0.59          |
| 220012897 | 071892       | Wheel 5 dia                      |
| 220013557 | 132359       | Wheel Caster                     |
| 220013668 | 041269       | Wheel Poly                       |
| 220015006 | 115032       | Wheel 5x2.88x2.44x0.83           |
| 220015019 | 115033       | Wheel 5x4.12x2.44x0.83           |
| 220015044 | 100462       | Wheel 3.25x6.5x2.047x1.44        |
| 220015049 | 088628       | Wheel 4x4.12x2.047x0.75          |
| 220015058 | 082021       | Wheel 6x2.75x3.149x0.83          |
| 220015616 | 073961       | Wheel 4x2.88x2.047x0.59          |
| 220016967 | 082021       | Wheel 6x2.75x3.149x0.83          |
| 220016976 | 077084       | Wheel 3.25x3.25x2.047x0.59       |
| 220017453 | 082285       | Wheel (Nylon)                    |

Yale Continued ▶

**Note:** You need to add the compound part number to the wheel base number listed above. See compounds listed on page 11.03 for the dash number. Complete part number format is XXXXXX-XXX.

# Wheel & Tire Cross References by Manufacturer

Continued ▶

Yale Continued

| OE Number  | Crown Number | Description                      |
|------------|--------------|----------------------------------|
| 220020717  | 082283       | Wheel Assm (Poly)                |
| 220021096  | 081520       | Wheel Caster Assm 10 x 3         |
| 220022590  | 073961       | Wheel 4x2.88x2.047x0.59          |
| 220023602  | 083179       | Wheel 4x2.50x2.047x0.59          |
| 220024613  | 115033       | Wheel 5x4.12x2.44x0.83           |
| 220028022  | 077086       | Wheel 3.25x5x2.047x0.59          |
| 220028358  | 083167       | Wheel Rubber Assm                |
| 220034310  | 310131       | Wheel 8.5x2.66x2.754xNon Typical |
| 220043337  | 083179       | Wheel 4x2.50x2.047x0.59          |
| 220044606  | 077086       | Wheel 3.25x5x2.047x0.59          |
| 220052145  | 071665       | Wheel Polyurethane               |
| 220052147  | 083879       | Roller Load                      |
| 500660501  | 310065       | Tire Poly 16.25x6x11.25          |
| 500660502  | 310066       | Tire Poly 16.25x7x11.25          |
| 500660503  | 310121       | Tire Poly 21x8x15                |
| 500660506  | 310066       | Tire Poly 16.25x7x11.25          |
| 500660507  | 310075       | Tire Poly 22x8x16                |
| 500660511  | 310071       | Tire Poly 18x8x12.125            |
| 500660512  | 310064       | Tire Poly 16.25x5x11.25          |
| 500660513  | 310066       | Tire Poly 16.25x7x11.25          |
| 500660514  | 310065       | Tire Poly 16.25x6x11.25          |
| 500660516  | 310121       | Tire Poly 21x8x15                |
| 500660519  | 310052       | Tire Poly 15x6x11.25             |
| 500660521  | 310065       | Tire Poly 16.25x6x11.25          |
| 500660522  | 310052       | Tire Poly 15x6x11.25             |
| 500660523  | 310072       | Tire Poly 18x9x12.125            |
| 500660524  | 310048       | Tire Poly 15x5x11.25             |
| 501593000  | 310183       | Wheel 4x2.75x2.44x0.843          |
| 501774915  | 107933       | Tire Poly 10x5x6.5 Contour       |
| 5017766932 | 079266       | Tire Poly 13x5.5x8               |
| 501776904  | 077848       | Tire Poly 9x5x5                  |
| 501776927  | 310025       | Tire Poly 12x4.5x8               |
| 501777904  | 310028       | Tire Poly 12x5.5x8               |
| 501786902  | 310002       | Tire Poly 8x4x6.25               |
| 501788915  | 107933       | Tire Poly 10x5x6.5 Contour       |
| 502036002  | 107933       | Tire Poly 10x5x6.5 Contour       |
| 503566503  | 310187       | Wheel 3.25x5.75x2.44x0.69        |
| 504246501  | 310088       | Wheel 3.38x2.75x2.047x0.812      |
| 504246502  | 310184       | Wheel 3.38x2.75x2.047x0.605      |
| 504449731  | 310164       | Wheel 5x2.88x2.047x0.59          |
| 504574233  | 310137       | Wheel 3.25x4.28x2.047x0.825      |
| 504574280  | 073961       | Wheel 4x2.88x2.047x0.59          |
| 504646501  | 310184       | Wheel 3.38x2.75x2.047x0.605      |
| 504646505  | 310187       | Wheel 3.25x5.75x2.44x0.69        |
| 504820503  | 310138       | Wheel 3.25x5.75x2.047x0.825      |
| 504910501  | 310184       | Wheel 3.38x2.75x2.047x0.605      |
| 504910502  | 310184       | Wheel 3.38x2.75x2.047x0.605      |
| 504910503  | 310138       | Wheel 3.25x5.75x2.047x0.825      |
| 504910505  | 310184       | Wheel 3.38x2.75x2.047x0.605      |
| 504919500  | 310012       | Tire Poly 10x5x6.5               |
| 504919501  | 310202       | Tire Poly 10x5x6.5 w/Bevel       |
| 504919501  | 107933       | Tire Poly 10x5x6.5 Contour       |
| 505596501  | 310093       | Wheel 3.25x6.5x1.98x1.177        |
| 506626501  | 312360       | Wheel 5x3.88x2.05x0.60           |
| 506626502  | 312360       | Wheel 5x3.88x2.05x0.60           |
| 506788501  | 310164       | Wheel 5x2.88x2.047x0.59          |
| 506788502  | 310164       | Wheel 5x2.88x2.047x0.59          |
| 506788503  | 310164       | Wheel 5x2.88x2.047x0.59          |
| 506790500  | 073961       | Wheel 4x2.88x2.047x0.59          |
| 506790501  | 073961       | Wheel 4x2.88x2.047x0.59          |
| 506790502  | 073961       | Wheel 4x2.88x2.047x0.59          |
| 506790503  | 073961       | Wheel 4x2.88x2.047x0.59          |
| 506837301  | 310096       | Wheel 6x2x2.44x0.625             |
| 515732816  | 310089       | Wheel 8x2x1.75xThru              |
| 515732830  | 310188       | Wheel 3.25x3.75x1.75xThru        |
| 515732831  | 310188       | Wheel 3.25x3.75x1.75xThru        |
| 516353810  | 310089       | Wheel 8x2x1.75xThru              |
| 518782600  | 310094       | Wheel 4x2x1.575x0.575            |
| 518822810  | 310186       | Wheel 4x2.37x1.938x0.96          |

| OE Number | Crown Number  | Description                      |
|-----------|---------------|----------------------------------|
| 518822829 | 310186        | Wheel 4x2.37x1.938x0.96          |
| 520318808 | 310094        | Wheel 4x2x1.575x0.575            |
| 522572001 | 310093        | Wheel 3.25x6.5x1.98x1.177        |
| 524140950 | 310240        | Wheel 3.25x6.5 Single Bearing    |
| 524140951 | 310041        | Wheel 3.25x6.5x2.047x1.681       |
| 524140951 | 100462        | Wheel 3.25x6.5x2.047x1.44        |
| 524148457 | 083179        | Wheel 4x2.50x2.047x0.59          |
| 524148750 | 310245        | Wheel 3.25x4.5x2.047x.710        |
| 524149477 | 310025        | Tire Poly 12x4.5x8               |
| 524150937 | 310298        | Wheel 4x1.75x2.44x0.81           |
| 524196822 | 310234        | Wheel 5x3.875x2.44x0.67          |
| 550023492 | 310245        | Wheel 3.25x4.5x2.047x.710        |
| 580006428 | 310039        | Tire Poly 13.5x5.5x8             |
| 580009181 | 310129        | Wheel 8.5x2.69x2.754x2.5         |
| 580016713 | 083179        | Wheel 4x2.50x2.047x0.59          |
| 580022365 | 073961        | Wheel 4x2.88x2.047x0.59          |
| 580022366 | 310164        | Wheel 5x2.88x2.047x0.59          |
| 580046742 | 310079        | Wheel 5x2.875x2.44x0.67          |
| 580062912 | 310299        | Caster Wheel 7.5x2.125           |
| 580067769 | 310234-306-88 | Wheel 5x3.875x2.44x.67 No Seal   |
| 580068147 | 310234-306-66 | Wheel 5x3.875x2.44x.67 Sealed    |
| 580070396 | 310234        | Wheel 5x3.875x2.44x0.67          |
| 590010047 | 310227        | Wheel 7x2.75x1.98                |
| 60215440C | 370355        | Wheel Rubber 5.5x5x2.19          |
| 620982100 | 154840        | Wheel 3.25x2x2.047x0.59          |
| 624148750 | 310136        | Wheel 3.25x4.71x2.047x0.825      |
| 720465001 | 310183        | Wheel 4x2.75x2.44x0.843          |
| 720465006 | 310183        | Wheel 4x2.75x2.44x0.843          |
| 721743000 | 310183        | Wheel 4x2.75x2.44x0.843          |
| 723227302 | 310198        | Tire Poly 6x3x4                  |
| 730320302 | 310133        | Wheel 5x2.88x2.44x0.775          |
| 752739301 | 310142        | Wheel 4x2.88x2.44x0.75           |
| 753009400 | 310025        | Tire Poly 12x4.5x8               |
| 754442400 | 312360        | Wheel 5x3.88x2.05x0.60           |
| 800017230 | 125070        | Wheel 6x4.12x3.149x0.98          |
| 800017585 | 127723        | Wheel Caster 8x4x2.83            |
| 800020380 | 077084        | Load Wheel Assm 3.25x3.25        |
| 800020380 | 092537        | Wheel Assm 3.25x3.25x2.047x0.59  |
| 800045244 | 083586        | Wheel 5x2.88x3.149x0.98          |
| 800045250 | 310131        | Wheel 8.5x2.66x2.754xNon Typical |
| 800045277 | 125070        | Wheel 6x4.12x3.149x0.98          |
| 800046166 | 073602        | Wheel 5 Steel Assm               |
| 800046167 | 125069        | Wheel 6x2.88x3.15x0.80           |
| 800050156 | 115032        | Wheel 5x2.88x2.44x0.83           |
| 800076056 | 071894        | Wheel 4 Poly                     |
| 800076068 | 073602        | Wheel 5 Steel Assm               |
| 800076205 | 082741        | Wheel Nylon                      |
| 800076404 | 082283        | Wheel Assm (Poly)                |
| 800114768 | 072718        | Wheel Assm Poly                  |
| 800114775 | 071892        | Wheel 5 dia                      |
| 800114779 | 071665        | Wheel Polyurethane               |
| 800114783 | 082021        | Wheel 6x2.75x3.149x0.83          |
| 800114787 | 077084        | Load Wheel Assm 3.25x3.25        |
| 800114787 | 092537        | Wheel Assm 3.25x3.25x2.047x0.59  |
| 800114802 | 311520        | Wheel 10x3 Caster                |
| 800114805 | 077084        | Load Wheel Assm 3.25x3.25        |
| 800114805 | 092537        | Wheel Assm 3.25x3.25x2.047x0.59  |
| 800114812 | 115033        | Wheel 5x4.12x2.44x0.83           |
| 800114818 | 100462        | Wheel 3.25x6.5x2.047x1.44        |
| 800114833 | 083179        | Wheel 4x2.50x2.047x0.59          |
| 800114837 | 083585        | Wheel 4x2.88x2.047x0.75          |
| 800114838 | 083585        | Wheel 4x2.88x2.047x0.75          |
| 800114845 | 088628        | Wheel 4x4.12x2.047x0.75          |
| 800114846 | 088628        | Wheel 4x4.12x2.047x0.75          |
| 800114851 | 083587        | Wheel 5x4.12x3.149x0.98          |
| 800114853 | 083586        | Wheel 5x2.88x3.149x0.98          |
| 800114856 | 115033        | Wheel 5x4.12x2.44x0.83           |
| 800114858 | 115033        | Wheel 5x4.12x2.44x0.83           |
| 800120656 | 123603        | Wheel 3.25x4.50x2.16x0.52        |

WHEELS AND TIRES

**Note:** You need to add the compound part number to the wheel base number listed above.  
See compounds listed on page 11.03 for the dash number. Complete part number format is XXXXXX-XXX.

⚠ WARNING: Cancer - www.P65Warnings.ca.gov

Yale Continued ▶

## Wheel & Tire Cross References by Manufacturer

Yale Continued

| OE Number  | Crown Number | Description                       |
|------------|--------------|-----------------------------------|
| 800120802  | 115032       | Wheel 5x2.88x2.44x0.83            |
| 800354576  | 310137       | Wheel 3.25x4.28x2.047x0.825       |
| 6200613100 | 310184       | Wheel 3.38x2.75x2.047x0.605       |
| 118P       | 310184       | Wheel 3.38x2.75x2.047x0.605       |
| 12056430A  | 310183       | Wheel 4x2.75x2.44x0.843           |
| R0101      | 310188       | Wheel 3.25x3.75x1.75xThru         |
| S107       | 310174       | Wheel 3.25x4x1.85x0.551           |
| S124       | 310078       | Wheel 3.25x2.88x2.047x0.59        |
| S127       | 310188       | Wheel 3.25x3.75x1.75xThru         |
| S128       | 310188       | Wheel 3.25x3.75x1.75xThru         |
| S129       | 310185       | Wheel 3.25x4.5x1.575x0.56         |
| S130       | 310170       | Wheel 3.38x2.75x2.047x0.91        |
| S137       | 310184       | Wheel 3.38x2.75x2.047x0.605       |
| S138       | 154840       | Wheel 3.25x2x2.047x0.59           |
| S139       | 154840       | Wheel 3.25x2x2.047x0.59           |
| S143       | 310183       | Wheel 4x2.75x2.44x0.843           |
| S144       | 310187       | Wheel 3.25x5.75x2.44x0.69         |
| S149       | 310186       | Wheel 4x2.37x1.938x0.96           |
| S152       | 310186       | Wheel 4x2.37x1.938x0.96           |
| S153       | 312360       | Wheel 5x3.88x2.05x0.60            |
| S186       | 310089       | Wheel 8x2x1.75xThru               |
| S188       | 310091       | Wheel 7.88x2.48x2.047xNon Typical |
| S230       | 310144       | Wheel 3.25x6x2.047x0.812          |
| S234       | 310193       | Wheel 4x2.75x1.78x0.72            |
| S420       | 154840       | Wheel 3.25x2x2.047x0.59           |
| S425       | 310137       | Wheel 3.25x4.28x2.047x0.825       |
| S441       | 310136       | Wheel 3.25x4.71x2.047x0.825       |
| S443       | 073961       | Wheel 4x2.88x2.047x0.59           |
| S446       | 310137       | Wheel 3.25x4.28x2.047x0.825       |
| S529       | 310144       | Wheel 3.25x6x2.047x0.812          |

| OE Number | Crown Number | Description                       |
|-----------|--------------|-----------------------------------|
| S542      | 310142       | Wheel 4x2.88x2.44x0.75            |
| S553      | 310133       | Wheel 5x2.88x2.44x0.775           |
| S553      | 310143       | Wheel 5x2.88x2.44x0.75            |
| S630      | 310185       | Wheel 3.25x4.5x1.575x0.56         |
| S653      | 310164       | Wheel 5x2.88x2.047x0.59           |
| S700      | 310178       | Wheel 3.25x5.91x2.047x1.18        |
| S819      | 310149       | Wheel 3.25x3x2.047x0.656          |
| S820      | 310185       | Wheel 3.25x4.5x1.575x0.56         |
| S821      | 310187       | Wheel 3.25x5.75x2.44x0.69         |
| S824      | 310186       | Wheel 4x2.37x1.938x0.96           |
| S825      | 310184       | Wheel 3.38x2.75x2.047x0.605       |
| S826      | 310103       | Wheel 4x2.63x2.44x0.77            |
| S827      | 310138       | Wheel 3.25x5.75x2.047x0.825       |
| S837      | 310174       | Wheel 3.25x4x1.85x0.551           |
| S844      | 310235       | Wheel 4x2.88x2.44x0.672           |
| S847      | 081645       | Wheel Poly                        |
| S848      | 310116       | Wheel 5x3.75x2.834x0.74           |
| S850      | 310093       | Wheel 3.25x6.5x1.98x1.177         |
| S851      | 073961       | Wheel 4x2.88x2.047x0.59           |
| S857      | 310164       | Wheel 5x2.88x2.047x0.59           |
| S872      | 310198       | Tire Poly 6x3x4                   |
| S888      | 310091       | Wheel 7.88x2.48x2.047xNon Typical |
| S9143     | 083179       | Wheel 4x2.50x2.047x0.59           |
| S9330     | 310188       | Wheel 3.25x3.75x1.75xThru         |
| S9380     | 310089       | Wheel 8x2x1.75xThru               |
| S9534     | 310174       | Wheel 3.25x4x1.85x0.551           |
| S9811     | 077086       | Wheel 3.25x5x2.047x0.59           |
| S9842     | 310181       | Wheel 4x2.88x2.44x0.832           |

**Note:** You need to add the compound part number to the wheel base number listed above. See compounds listed on page 11.03 for the dash number. Complete part number format is XXXXXX-XXX.

WHEELS AND TIRES







**Forklift Laser Guidance Systems**

**Reduce Damage and Increase Productivity**

See Work Assist Section

## IC Planned Maintenance and Tune-Up Kits

Available for IC forklifts and engine types from a wide variety of manufacturers.



### Planned Maintenance Kits Include:

- Air Filter
- Oil Filter
- 10W30 Motor Oil

### Tune-Up Kits Include:

- Distributor Cap
- Rotor
- Spark Plugs
- Ignition Wire Set



See IC Truck Components Section



## Section 12

# Crown Operator and Service Training

### Contents

|   |       |
|---|-------|
| Operator Training Workshops             | 12.02 |
| Operator Training Materials             | 12.03 |
| Service Training Workshops              | 12.04 |
| Supplemental Service Training Materials | 12.05 |





**Demonstrated Performance®**

Operator Training

# Operator Training Workshops

CROWN OPERATOR AND SERVICE TRAINING

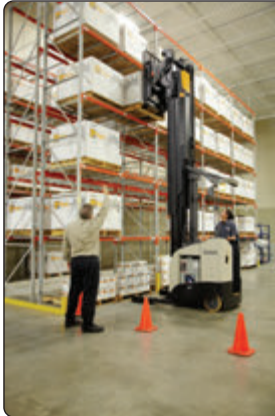

## DP MoveSafe® - Train-the-Operator

Crown's nationwide network of factory-trained instructors offer full-service training programs. Conducted at your site, these highly trained instructor led sessions present the full gamut of powered industrial truck safety information with clear, understandable and highly visual video and animated presentations. Hands-on time is maximized and structured to assure your operators are trained not only in truck operation and task performance, but in safe operating habits and practices as well. These are crucial in the effective training of your operators.

Contact your local Crown lift truck dealer for available dates and pricing.

## DP LeadSafe® - Train-the-Supervisor

Supervisors of lift truck operators play a critical role in reinforcing the safe operating skills and habits taught during operator training sessions. To help them do this, Crown offers the award winning\* LeadSafe Program in a Demonstrated Performance format to help them learn and demonstrate how to effectively supervise lift truck operators and reinforce safe operating habits.

**The workshop covers topics such as:** Identifying Proper and Improper Operation, Recognizing Potential Hazards, and Giving Feedback to Operators.

Contact your local Crown lift truck dealer for pricing. Crown's Operator Training Programs are optimized for interactive streaming. The training can be hosted and tracked on Crown's Learning Management System (LMS) or utilized within your current Learning Management System (LMS). Each program has a step by step interface guiding the user through the training process.

## DP TrainSafe® - Train-the-Trainer

DP TrainSafe uses Crown's award winning, hands-on, Demonstrated Performance approach to deliver the best and most comprehensive operator train-the-trainer program in the industry. Participants in the two day TrainSafe program will learn and practice implementing Crown's MoveSafe operator training programs, 11 step hands-on training and safe skill and habit development process. Trainers will leave with the skills needed to conduct these workshops, as well as three year re-evaluations, safety refreshers (workshops), warehouse inspections, and much more.

**DP TrainSafe is offered at most Crown dealers.**

Contact your local Crown lift truck dealer for available dates and pricing.

Available Operator Training Materials listed on page 12.03

Visit Crown.com for more Training information and to locate your closest Crown dealer.



\*2008 International Society for Performance Improvement Award of Excellence

To view information videos on DP TrainSafe®, DP MoveSafe® and DP LeadSafe®, go to:  
<http://www.youtube.com/user/CrownEquipment>



**Demonstrated Performance**

Operator Training

# Operator Training Materials

**Crown offers the most comprehensive line of training tools to help maximize your resources for more effective Operator Training.**

Crown's Operator Training Programs are optimized for interactive streaming. The training can be hosted and tracked on Crown's Learning Management System (LMS) or utilized within your current Learning Management System (LMS). Each program has a step by step interface guiding the user through the training process.

All lift truck programs are available in English and Spanish, including the 11-step hands on training process.



## Operator Training Programs

**Note:** All programs are bilingual, English and Spanish

| Program Name   | Part Number        |
|--|--------------------|
| <b>It's Up to You</b><br>(Required with programs marked with † below ) | <b>SF18329-PRO</b> |
| GPW Series Walkie Pallet Trucks †                                      | SF12480-PRO        |
| PW3500 Series Walkie Pallet Trucks †                                   | SF12481-PRO        |
| WP2000 Series Walkie Pallet Trucks †                                   | SF12858-PRO        |
| WP2300-3000 Series Walkie Pallet Trucks                                | SF18995-PRO        |
| B Series Power Lift Stackers †   | SF12478-PRO        |
| M Series Intermediate Duty Walkie Stackers †                           | SF12479-PRO        |
| SH/SHR, ST/SX3000 and WE/WS2300 Series                                 | SF18007-PRO        |
| W/WR Series Walkie Stackers †  | SF12486-PRO-W      |
| WB Series Walkie Stackers †  | SF12486-PRO-WB     |
| WE/WS 2000 Series Walkie Stackers †                                    | SF12617-PRO        |
| PC4500 Series Rider Pallet Trucks                                      | SF18534-PRO        |
| PE4000-4500 Series Rider Pallet Trucks                                 | SF19245-PRO        |
| PR3000-4500 Series Rider Pallet Trucks †                               | SF12484-PRO        |
| RT4000 Series Rider Pallet Trucks                                      | SF19959-PRO        |
| TR-TWR 3000-3600 Series Tow Tractors †                                 | SF12485-PRO        |

| Program Name                                     | Part Number |
|--|-------------|
| RC3000 Series Stand-up Riders †                  | SF12487-PRO |
| RC5500 Series Stand-up Riders                    | SF14751-PRO |
| RR/RD 3000-3500 Series Reach Trucks †            | SF12490-PRO |
| RR/RD-RM/RMD 5000-6000 Series Reach Trucks       | SF18375-PRO |
| C5 Series Internal Combustion Class IV and V     | SF18399-PRO |
| IC Class IV and V Internal Combustion Trucks     | SF18092-PRO |
| FC-FP Series Four Wheel Sit-Down Trucks †        | SF12489-PRO |
| FC4000-4500 Series Four Wheel Sit-Down Trucks †  | SF14016-PRO |
| SC Series Three Wheel Sit-Down Lift Trucks †     | SF12488-PRO |
| SC4000-4500 Series Three Wheel Sit-Down Trucks † | SF12755-PRO |
| SP36-48 Series Stockpickers †                    | SF12492-PRO |
| SP3000-4000 Series Stockpickers                  | SF18996-PRO |
| TS Series Turret Sideloaders †                   | SF12493-PRO |
| TSP Series Turret Sideloaders †                  | SF12494-PRO |
| TSP 6000-7000 Series Turret Sideloaders †        | SF14559-PRO |
| Wave® Work Assist Vehicle                        | SF19571-PRO |

## Trainer's and Supervisor's Tools

| Program Name   | Part Number |
|--|-------------|
| Notice of Completion Certificates (Package of 100)             | SF12464     |
| Trainer's Binder   | SF12756-PRO |
| Trainer's Binder Kit - Contains Operator Training Resource USB | SF12756-KIT |
| Triennial Evaluation Program                                   | SF18025-PRO |
| Safety Awareness Topics Program                                | SF18026-PRO |
| Triennial/Safety Topics Bundle                                 | SF18322-PKG |

## Pedestrian Training

| Program Name              | Part Number |
|---------------------------|-------------|
| Pedestrian Safety Program | SF18590-PRO |

## Stand-Up Safety

| Program Name  | Part Number |
|---|-------------|
| Stand-Up Safety<br>Included in RC3000 & RR/RS/RD 3000/3500. | PF12396-DVD |

## Supervisor's Training

| Program Name                           | Part Number |
|--|-------------|
| LeadSafe Program Streaming Option Only | SF14763-KIT |

## Operator Manuals

See your local Crown dealer or find part numbers at this link:  
[http://www.crown.com/usa/parts/lookup\\_tool.html](http://www.crown.com/usa/parts/lookup_tool.html)



**Demonstrated Performance<sup>®</sup>**

Service Training

## Service Training Workshops

CROWN OPERATOR AND SERVICE TRAINING



### DP Service Training - For your Lift Truck Technicians

**Our award winning\* Demonstrated Performance service training workshops give your technicians the Crown-specific skills and knowledge they need to keep your Crown fleet up and running.** Since many technicians are hands-on learners, they're more likely to retain information learned through first-hand experience than material presented in a lecture. Crown's Demonstrated Performance Service Technician Training goes above and beyond traditional classroom training, allowing participants to work on trucks with instructor supervision. Technicians can move at their own pace and focus on the particular tasks and skill groups that best serve their organization's needs.

**Learn It.  
Do It.  
Use It.<sup>®</sup>**

This defines the philosophy behind Crown DP training. Participants "Learn it" by reading the module, reviewing any reference material, and practicing the required skills. Then they "Do it" by performing what we call a "skill check" for the instructor to demonstrate their ability to perform the skill. This prepares them to bring their newly acquired skills back to their job and "Use it" to improve the uptime and reliability of Crown lift trucks.

**Demonstrated Performance workshops are completely customizable to the needs of your technician.** They'll only spend time on what they need to learn, and only work on the trucks that apply to them. For example, they won't spend two hours learning about basic electricity if they already know it. Before the DP training course spend some time talking to your technician about what you want them to cover during the session. Do you want them to focus on mechanical topics, such as repairing or replacing components? Or do you want them to learn how to troubleshoot the electrical system? Contact one of the following Regional Training Centers and the Regional Service Trainer to have a customized training course map developed to match your need.

**DP Service Training is offered at the following Regional Training Centers. To schedule, email [Education.center@crowncorp.com](mailto:Education.center@crowncorp.com)**

Atlanta, GA  
Franklin, MA  
Dallas, TX  
Dayton, OH  
Kansas City, KS  
Los Angeles, CA  
Schaumburg, IL  
Toledo, OH

\*2006 International Society for Performance Improvement Award of Excellence



The programs listed below cover fundamental principles and systems that can apply to many truck models.

For Crown DP Service Training, contact one of Crown's Regional DP Service Training locations listed on the previous page.

### Service Training Programs

#### PM Training

| Program Name           | Part Number |
|------------------------|-------------|
| RR/RD5000-5700 - PM    | PF18983-PRO |
| PE4000-4500 - PM       | PF18984-PRO |
| PR4000-4500 - PM       | PF18985-PRO |
| SP3000-4000 - PM       | PF18986-PRO |
| RC5500 - PM            | PF18987-PRO |
| C5 - PM                | PF19243-PRO |
| RM/RMD6000 Series - PM | PF19836-PRO |

#### Legacy Programs

| Program Name                                   | Part Number |
|--|-------------|
| FC 4000 EV100                                  | PF13437-PRO |
| RR 5000 Hydraulics                             | PF13044-PRO |
| RR 5000 Wiring Diagrams                        | PF13342-PRO |
| SC 4000 Series                                 | PF12825-PRO |
| Basic Electricity, Hydraulics and Motor Theory | PF18660-102 |

## Supplemental Service Training Materials



- Absorbent Products..... 1.12, 1.17-1.19, 2.15-2.16  
Accelerator..... 5.52  
Accu-Tilt..... 6.15  
Adhesives..... 1.21-1.22  
Adhesive Eraser..... 1.14, 9.23  
Aerosols..... 1.08-1.09  
Air Filters..... 1.26-1.46  
Air Pneumatic Tires..... 11.27  
Aircraft Cable..... 4.19  
Alarms..... 4.10, 7.04  
Alternators..... 5.19-5.21  
Antifreeze & Test Kit..... 1.04-1.05  
Anti-Slip Floor Tape..... 3.05  
Aprons..... 2.12, 8.43  
Attachment Parts..... 7.12-7.18  
Automotive Battery Connectors..... 5.61, 8.38  
Axles, Shafts & Pins  
..... 4.48-4.49, 4.53-4.55, 5.52-5.54, 11.11-11.15  
Back-Up Alarms..... 4.10  
Bags  
Trash Can..... 1.19  
Battery Cell..... 8.43  
Batteries..... 8.13-8.19  
Battery  
Acid Indicators..... 8.39  
Cable Assemblies..... 8.09-8.10, 8.31-8.32  
Cable Mount..... 8.06, 8.29  
Cable Retractor..... 8.06, 8.29  
Capacity Indicator..... 4.31-4.32  
Caps..... 8.33  
Cell Bag..... 8.43  
Connectors..... 8.33-8.37  
Demo Watering Kit..... 8.22  
Discharge Indicator..... 4.31-4.32  
Display Rack..... 8.17  
Extractor, Strap & Hook..... 8.42, 9.05  
Monitoring..... 8.05, 8.39, 9.16  
Spill Kit..... 2.16, 8.44  
Strap..... 8.29  
Tester..... 8.40, 9.16  
Tools..... 8.24, 8.28, 8.39-8.42  
Watering..... 8.21-8.28  
BDI..... 4.31-4.32  
Bearings..... 4.33-4.35, 4.73, 11.16-11.18  
Belts  
Fan..... 5.45-5.46  
Seat..... 2.02, 5.08  
Timing..... 4.55, 5.46  
Biljax OEM Parts..... 3.19-3.20  
Blackout Lens..... 4.06  
Bollards..... 3.02  
Borescope..... 9.08  
Brackets..... 2.14, 4.04, 8.05-8.06, 8.29  
Brake  
Adjuster..... 5.29  
Cable..... 4.56, 5.29  
Cylinders..... 5.32-5.33  
Disc..... 4.56  
Electric..... 4.56  
Emergency Handle..... 5.28-5.29  
Fluid..... 1.04  
Pads..... 5.27  
Pedal/Pedal Cover..... 5.27, 5.31  
Rotors..... 4.56  
Shoes..... 5.25-5.27  
Springs..... 5.27-5.28, 5.29  
Tail/Back-Up Lights..... 4.05  
Tools..... 9.17  
Breathing Protection..... 2.09  
Brush  
Motor..... 4.61-4.66  
Spring..... 4.67-4.68  
Bulbs..... 4.02  
Bumpers..... 3.02  
Bushings..... 4.33-4.35, 4.43-4.44, 4.49, 4.54, 5.55  
Buttons..... 4.50, 4.52, 4.71, 4.73, 5.60  
Cable  
Aircraft..... 4.19  
Cable..... 5.61  
Camera..... 6.13  
Control..... 4.19  
Emergency Brake..... 5.29  
Ends..... 8.38  
Parking Brake..... 4.56, 5.29  
Power..... 4.19, 8.38  
Retractors, Battery..... 8.06, 8.38  
Ties..... 1.16, 8.38  
Camera Systems..... 6.13-6.14  
Can Liners..... 1.19  
Cap  
Buffant..... 2.11  
Knit Cap with LED Light..... 2.12  
Caps, Distributor..... 5.375-5.41  
Carabiners..... 2.05-2.06  
Cards, Electronic..... 4.27-4.29  
Cart..... 3.14, 8.20, 9.05  
Cascade Parts..... 7.13-7.15  
Caster, Wheels..... 3.16, 4.45, 11.07-11.09  
Chain..... 3.04, 7.07-7.08, 11.28  
Chain Wear Gauge..... 7.08, 9.05  
Charger Stands..... 8.04  
Chargers..... 8.02-8.03, 8.06-8.07  
Checklist..... 8.11  
Chemicals..... 1.22-1.25  
Chocks, Wheel..... 3.11-3.12, 9.21  
Cleaners..... 1.07-1.10, 1.12, 3.07, 8.43-8.44  
Clutch Cover..... 5.60  
Coils..... 5.41  
Compressor Oil..... 1.03  
Cones, Traffic..... 2.14  
Connectors  
Battery..... 8.33-8.37  
Deutsch..... 4.11  
Connecting Link..... 5.57-5.58  
Contactor, Tips..... 4.26  
Contactors..... 4.24-4.25  
Control Cable..... 4.19  
Control Cards..... 4.27-4.29  
Converters  
DC/DC..... 4.29  
Propane..... 5.09-5.10  
Torque..... 5.51  
Coolant..... 1.04-1.05  
Cord, Replacement..... 3.22, 4.70, 8.08  
Couplings..... 10.03-10.08  
Cover  
Clutch..... 5.60  
Forklift..... 6.18  
Hub..... 5.59  
Water Pump..... 5.17-5.18  
Coveralls..... 2.11-2.12  
Crimping Tools..... 8.34, 8.42, 9.08-9.10, 9.16, 9.19-9.20  
Cross References  
Battery..... 8.18-8.19  
Filters..... 1.26-1.46  
Righttime Parts..... 7.17-7.18  
Wheels & Tires..... 11.34-11.50  
Cylinders..... 4.56, 4.69, 5.32-5.35  
DC/DC Converters..... 4.29  
De-icer..... 1.05  
Deionizers..... 8.23  
Demo Watering Kit..... 8.22  
Diagnostic Tools..... 9.14-9.16  
Diaphragm Kit..... 5.12  
DIN Connectors..... 8.36-8.37  
Dipstick..... 5.63  
Disc Brakes..... 4.56  
Dispensers  
Chemical..... 1.07, 1.12-1.13  
Towel..... 1.18-1.19  
Wipe..... 1.10  
Disposable Clothing..... 2.11-2.12  
Distributors & Caps..... 5.37-5.41  
Dockboards..... 3.17  
Dome Lights..... 4.05  
Drive Motors..... 4.58-4.60  
Drive Tools..... 9.13  
Drive Unit Parts..... 4.49-4.56  
Drum, 55 Gallon..... 1.12  
Durometer..... 9.05, 11.24  
Ear Protection..... 2.08  
Electrical Tools..... 9.18-9.20  
Electronic Cards..... 4.27-4.29  
Emergency Brake Handle..... 5.28-5.29  
Emergency Brake Switch..... 4.72  
Encoder..... 4.53  
Evacuator, Fluid..... 9.17  
Exhaust Pipe..... 5.51  
Expandable Sleeving..... 8.38  
Extraction Tools..... 9.19-9.20  
Eye  
Wash..... 2.08, 8.44  
Wash Station..... 2.08, 8.45  
Face Shields..... 2.10  
Fall Protection..... 2.03-2.06  
Fan..... 6.07  
Fan  
Belts..... 5.45-5.46  
Blades..... 5.44  
Filler, Repair Body..... 1.25  
Filters, Air, Fuel, Hydraulic & Oil..... 1.26-1.46, 5.12-5.13  
Fire Extinguisher..... 2.14  
First Aid Kits..... 2.16  
Flaps..... 11.27  
Flashing Lights..... 2.14, 4.07, 6.07  
Flashlight..... 1.03, 9.04, 9.16  
Float Systems & Parts..... 8.21-8.28  
Floor  
Cleaner..... 1.12, 3.07, 8.43  
Mats..... 1.20, 2.15, 3.18, 8.43  
Signs..... 3.08-3.09  
Tape..... 3.04-3.09  
Fluids..... 1.04-1.05  
Fluorescent Dye..... 1.03  
Fork..... 7.09-7.10, 7.16  
Covers, Magnetic..... 7.11  
Extenders..... 7.11  
Labels..... 7.09

|  |  |
|--|--|
| Pallet Protector.....                      | 7.12   |
| Pin Kits.....                              | 7.08   |
| Wear Calipers.....                         | 7.10, 9.05                                     |
| Forklift.....                              |  |
| Cover.....                                 | 6.18   |
| Jack.....                                  | 9.06   |
| Laser Guidance Systems.....                | 6.15 - 6.17                                    |
| Fuel Filters.....                          | 1.26-1.46, 5.13                                |
| Fuel/Water Separators Filters.....         | 1.26-1.46, 5.13                                |
| Fuses.....                                 | 4.20-4.23                                      |
| Gas Springs.....                           | 4.55, 5.60                                     |
| Gaskets.....                               | 1.24-1.25, 5.18, 5.56                          |
| Gear Oil.....                              | 1.03   |
| Genie OEM Parts.....                       | 3.21-3.22                                      |
| Glasses, Safety.....                       | 1.03, 2.07                                     |
| Gloves.....                                | 1.14-1.16                                      |
| Goggles.....                               | 2.07   |
| Grease.....                                | 1.05-1.06, 1.11                                |
| Guns.....                                  | 1.06, 9.23                                     |
| Fittings.....                              | 4.45, 5.56                                     |
| Pump.....                                  | 1.06   |
| Grip, Handle.....                          | 4.50-4.51                                      |
| Grounding Strap.....                       | 4.12   |
| Hand Cleaners.....                         | 1.07   |
| Hand Truck Dolly.....                      | 3.14, 8.20, 9.05                               |
| Hand Trucks.....                           |  |
| P-Handle.....                              | 3.14   |
| Personal.....                              | 3.14, 8.20, 9.05                               |
| Handles.....                               | 4.48, 4.50-4.51, 5.28, 8.35                    |
| Hard Hat.....                              | 2.12   |
| Harnesses.....                             |  |
| Body.....                                  | 2.03-2.04, 2.06                                |
| Wire.....                                  | 4.48, 4.51, 7.04                               |
| Heat Shrink Tubing.....                    | 8.39   |
| Hopper.....                                | 3.15-3.16                                      |
| Horn.....                                  | 4.09-4.10, 5.60                                |
| Parts.....                                 | 4.52, 4.70-4.71, 5.60                          |
| Hose.....                                  | 5.23, 5.61, 8.22-8.25, 8.27-8.28, 10.02, 10.05 |
| Sheave.....                                | 5.28, 5.59                                     |
| Hour Meters.....                           | 4.31-4.32                                      |
| Hubs.....                                  | 11.22-11.23                                    |
| Cover.....                                 | 5.59   |
| Hydraulic.....                             |  |
| Filters.....                               | 1.26-1.46, 5.62                                |
| Fluid.....                                 | 1.04-1.05                                      |
| Oil.....                                   | 1.02-1.03                                      |
| Oil Additive.....                          | 1.03   |
| Pump.....                                  | 5.18   |
| Tools.....                                 | 9.09-9.12                                      |
| Hyster, Yale, Raymond Parts Breakdown..... | 4.33-4.35, 4.48-4.49                           |
| Ignition.....                              |  |
| Coils.....                                 | 5.41   |
| Rotors.....                                | 5.37-5.41                                      |
| Switches.....                              | 4.16-4.18                                      |
| Wire Sets.....                             | 5.37-5.40                                      |
| InfoLink® Replacement Parts.....           | 7.03   |
| Injector.....                              | 5.12-5.13                                      |
| Injector Watering System.....              | 8.26-8.28                                      |
| Intercell Shroud.....                      | 8.30   |
| Intercells.....                            | 8.30   |
| Jacks.....                                 |  |
| Forklift.....                              | 9.06   |
| Machinery.....                             | 3.12-3.13                                      |
| Trailer.....                               | 3.13   |

|                                       |                        |
|---------------------------------------|------------------------|
| Jump Packs.....                       | 8.20                   |
| Key Pad.....                          | 2.14, 6.08             |
| Keys.....                             | 4.16-4.18              |
| Kneeling Pad.....                     | 1.16                   |
| Knife, Utility.....                   | 1.22                   |
| Knuckles.....                         | 5.62                   |
| Knurled Nut Replacements.....         | 4.18                   |
| Labels.....                           |                        |
| Fork Tip Indicator.....               | 7.09                   |
| Protectors.....                       | 3.07                   |
| Sideshift.....                        | 7.10                   |
| Ladders.....                          | 3.09, 3.23             |
| Lamps.....                            | 4.04-4.06              |
| Lanyards.....                         | 2.05-2.06, 2.11        |
| Lasers, Forklift Guidance System..... | 6.15-6.17              |
| Lead, Pellets & Sticks.....           | 8.40-8.41              |
| Lead Wire.....                        | 4.19                   |
| Leadhead Shrouds.....                 | 8.30                   |
| Leadheads.....                        | 8.31-8.32              |
| Leaf Chain.....                       | 7.07                   |
| Leak Detection.....                   | 1.03                   |
| LED.....                              |                        |
| Flashlight.....                       | 9.04                   |
| Knit Cap with LED Light.....          | 2.12                   |
| Strobe.....                           | 4.06                   |
| Tail Lights.....                      | 4.05                   |
| Work Lights.....                      | 4.03-4.05, 4.08, 6.07  |
| Lights.....                           |                        |
| Bulbs.....                            | 4.02                   |
| Dome.....                             | 4.05, 6.07             |
| Flashing.....                         | 4.07, 6.07             |
| LED.....                              | 4.03-4.08              |
| Spotlight.....                        | 4.04-4.05, 4.08        |
| Light Kits, Blue/Red.....             | 4.08                   |
| Strobes.....                          | 4.06, 6.07, 7.04       |
| Tail.....                             | 4.05                   |
| Work.....                             | 4.03-4.05, 4.08, 6.07  |
| Liners, Trash Can.....                | 1.19                   |
| Lithium-Ion Batteries.....            | 8.13                   |
| Load Wheel Assemblies.....            | 4.44, 11.10            |
| Load Wheel Kits.....                  | 11.12-11.15            |
| Lockout Devices.....                  | 2.13                   |
| LPG.....                              |                        |
| Tanks.....                            | 5.09                   |
| Parts.....                            | 5.09-5.13              |
| LPG Safety Valve.....                 | 5.09                   |
| Lubricants.....                       | 1.11, 1.23             |
| Mask, Breathing.....                  | 2.09                   |
| Master Cylinders.....                 | 4.69, 5.32             |
| Mats, Floor.....                      | 1.20, 2.15, 3.18, 8.43 |
| Mechanical Tools.....                 | 9.05-9.08              |
| Meters.....                           | 4.31-4.32, 9.14-9.16   |
| Mirrors.....                          | 2.02, 9.03             |
| Modules, InfoLink®.....               | 7.03                   |
| Monitors.....                         | 6.14                   |
| Motor Oil.....                        | 1.02                   |
| Motors.....                           |                        |
| Drive.....                            | 4.58-4.60              |
| Pump.....                             | 4.57-4.58              |
| Steer.....                            | 4.60-4.61              |
| Neutralizing Wash.....                | 1.12, 8.43             |
| Oil Additive.....                     | 1.03                   |
| Oil Filters.....                      | 1.26-1.46              |
| Oils.....                             | 1.02-1.03              |
| Operator Training.....                | 12.02-12.03            |

|  |   |
|--|---|
| Pad.....                                   |   |
| Kneeling.....                              | 1.16                                    |
| Deadman.....                               | 4.56                                    |
| Paint.....                                 | 1.14                                    |
| Suit.....                                  | 2.12                                    |
| Pallet Trucks (PTH & PTH50S/PS).....       | 7.05-7.06                               |
| Pallets & Accessories.....                 | 3.10                                    |
| Pin Kits, Fork.....                        | 7.08                                    |
| Pins, Axles & Shafts.....                  | 4.33-4.42, 4.51, 5.52-5.54, 11.11-11.15 |
| Pipe.....                                  | 5.51                                    |
| Planned Maintenance & Tune-Up Kits.....    | 5.36                                    |
| Platforms.....                             | 3.09, 6.08                              |
| Plug Kits.....                             | 4.11                                    |
| Pneumatic Tires.....                       | 11.25-11.27                             |
| Pogo Stick.....                            | 8.05-8.06, 8.29                         |
| Poly Tires.....                            | 11.19-11.20                             |
| Potentiometer.....                         | 3.19, 4.53, 9.15                        |
| Power Cable.....                           | 4.19, 8.38                              |
| Power Cord, Replacement.....               | 4.70, 8.08                              |
| Power Supply.....                          | 4.29, 7.04                              |
| Fuel/LPG Parts.....                        | 5.09-5.13                               |
| Propane Tanks.....                         | 5.09                                    |
| Protection.....                            |   |
| Breathing.....                             | 2.09                                    |
| Charger Stand.....                         | 8.04                                    |
| Rack.....                                  | 3.03                                    |
| Ear.....                                   | 2.08                                    |
| Fall.....                                  | 2.03-2.05                               |
| Prybar.....                                | 9.08                                    |
| Pumps.....                                 |   |
| Battery Watering.....                      | 8.22, 8.24, 8.27                        |
| Grease.....                                | 1.06                                    |
| Hand.....                                  | 1.03, 1.07, 1.12, 9.12                  |
| Hydraulic.....                             | 4.61, 5.18                              |
| Motors.....                                | 4.57-4.58                               |
| Transmission Charging.....                 | 5.51                                    |
| Water.....                                 | 5.17-5.18                               |
| Quick Change Load Wheels.....              | 11.10                                   |
| Rack.....                                  |   |
| Battery Display.....                       | 8.17                                    |
| Tire.....                                  | 11.21                                   |
| Rack Protection.....                       | 3.03                                    |
| Radiators & Accessories.....               | 5.21-5.24                               |
| Rags.....                                  | 1.17-1.19                               |
| RAM Mounts.....                            | 6.09-6.12                               |
| Ramp.....                                  | 9.05                                    |
| Raymond, Hyster, Yale Parts Breakdown..... | 4.33-4.35, 4.48-4.49                    |
| Regulator.....                             | 5.11                                    |
| Repair Body Filler.....                    | 1.25                                    |
| Rescue Booster Pack.....                   | 8.20                                    |
| Reservoir.....                             | 4.68                                    |
| Cap.....                                   | 5.63                                    |
| Resilient Tires.....                       | 11.25-11.27                             |
| Respiratory.....                           |   |
| Cartridges.....                            | 2.09                                    |
| Masks.....                                 | 2.09                                    |
| Rightline.....                             |   |
| Replacement Parts.....                     | 7.17-7.18                               |
| Fork Assemblies.....                       | 7.16                                    |
| Rims.....                                  | 11.27                                   |
| Risers.....                                | 4.33-4.36                               |
| Roller Chain.....                          | 7.08                                    |
| Rotors.....                                |   |
| Brake.....                                 | 4.56                                    |

## Section 13 - Index

|                                     |   |
|-------------------------------------|---|
| Ignition .....                      | 5.37-5.41                                     |
| Rubber Tires .....                  | 11.29-11.33                                   |
| Safety                              |   |
| Cones .....                         | 2.14  |
| Glasses .....                       | 1.03, 2.07                                    |
| Vests .....                         | 2.11  |
| Sanding Discs .....                 | 1.14, 9.23                                    |
| Sealant .....                       | 1.24-1.25                                     |
| Seals .....                         | 5.47-5.50                                     |
| Seat                                |   |
| Belts .....                         | 2.02, 5.08                                    |
| Cushions .....                      | 5.06-5.07                                     |
| Switches .....                      | 5.02-5.07                                     |
| Tracks .....                        | 5.07  |
| Seats .....                         | 5.02-5.06                                     |
| Self-Retracting Lanyard .....       | 2.05  |
| Self-Retracting Life Line .....     | 2.06  |
| Sensor .....                        | 4.53, 4.72, 4.75, 5.13, 5.57-5.59, 5.61, 7.04 |
| Service Training .....              | 12.04-12.05                                   |
| Shafts, Axles & Pins                |   |
| .....                               | 4.35-4.42, 4.54-4.55, 5.53-5.54, 11.11-11.15  |
| Shoe Covers .....                   | 2.10  |
| Shoes, Brake .....                  | 5.25-5.27                                     |
| Shop Vac .....                      | 9.05  |
| Shrink Wrap .....                   | 1.22  |
| Shrink Wrap Holders .....           | 6.02, 6.06                                    |
| Shrouds, Leadhead & Intercell ..... | 8.30  |
| Sideshift Label .....               | 7.10  |
| Signs .....                         | 2.13, 3.08-3.09                               |
| Skyjack OEM Parts .....             | 3.23-3.24                                     |
| Sleeving .....                      | 8.38  |
| Solenoids .....                     | 3.19, 3.21, 4.30-4.31, 4.48, 4.70, 5.16, 5.59 |
| Spark Plug                          |   |
| Tube .....                          | 5.41  |
| Wires .....                         | 5.36-5.40                                     |
| Spark Plugs .....                   | 5.42-5.44                                     |
| Spill Kits .....                    | 1.12, 2.15-2.16, 8.43-8.44                    |
| Spotlights .....                    | 4.04-4.05, 4.08                               |
| Spray Nozzle Quarts .....           | 1.13  |
| Sprayer/Bottles .....               | 1.13  |
| Springs .....                       | 4.46, 4.48, 4.51, 4.54, 4.71-4.72             |
| Brake .....                         | 5.27-5.30                                     |
| Brush .....                         | 4.61-4.66                                     |
| Gas .....                           | 4.48, 5.55, 5.60                              |
| Return .....                        | 4.51, 4.55, 4.72                              |
| Starters .....                      | 5.14-5.16                                     |
| Static Strap .....                  | 4.12  |
| Steer Motors .....                  | 4.60-4.61                                     |
| Steering Link .....                 | 5.57  |

|                           |  |
|---------------------------|--|
| Steering Tools .....      | 9.16   |
| Storage Net .....         | 6.05   |
| Storage Trays .....       | 3.10, 6.04-6.05, 9.04  |
| Stretch Film .....        | 1.22   |
| Strobe Lights .....       | 4.06, 6.07, 7.04   |
| Suppressor .....          | 4.10   |
| Switches .....            | 3.19, 4.12-4.18, 4.52, 4.71-4.73, 5.02-5.07, 5.13, 5.57, 5.61-5.62 |
| Tail Lights .....         | 4.05   |
| Tanks, LP .....           | 5.09   |
| Tape                      |  |
| Adhesive .....            | 1.21-1.22  |
| Applicator .....          | 3.05   |
| Caution .....             | 2.13   |
| Dispenser .....           | 1.22   |
| Floor .....               | 3.04-3.07  |
| Tender Kit .....          | 8.06, 8.29   |
| Terminal                  |  |
| Battery .....             | 5.61, 8.33-8.37  |
| Lugs .....                | 8.38   |
| Mounting Plates .....     | 6.03   |
| Protectors .....          | 8.33   |
| Thermostats .....         | 5.24   |
| Throttle, Body .....      | 5.12   |
| Tie Rod End .....         | 5.58   |
| Ties, Cable .....         | 1.16, 8.38   |
| Tips, Contactor .....     | 4.26   |
| Tire Chains .....         | 11.28  |
| Tires                     |  |
| Hole .....                | 11.21  |
| Poly .....                | 4.53, 11.19-11.21  |
| Press & Rings .....       | 11.24  |
| Rack .....                | 11.21  |
| Resilient/Pneumatic ..... | 11.25-11.27  |
| Rubber .....              | 11.29-11.33  |
| Tools                     |  |
| Battery .....             | 8.24, 8.28, 8.39-8.42  |
| Box .....                 | 9.04   |
| Brake .....               | 9.17   |
| Crimping .....            | 8.34, 8.42, 9.08-9.10, 9.16, 9.19-9.20                             |
| Crown Branded Tools ..... | 9.02-9.04  |
| Diagnostic .....          | 9.14-9.16  |
| Drive .....               | 9.13   |
| Electrical .....          | 9.18-9.20  |
| Extraction .....          | 9.19-9.20  |
| Hydraulic .....           | 9.09-9.12  |
| Mechanical .....          | 9.05-9.08  |
| Retractor .....           | 6.08, 9.06   |
| Steering .....            | 9.16   |

|  |   |
|--|---|
| Towels .....                             | 1.17-1.19                                 |
| Traffic Cones .....                      | 2.14                                      |
| Training Programs .....                  | 12.02-12.05                               |
| Transmission                             |   |
| Evacuator .....                          | 9.17                                      |
| Filter .....                             | 1.26-1.46                                 |
| Fluid .....                              | 1.04                                      |
| Strainer & Cup .....                     | 5.51                                      |
| Trash Can Liners .....                   | 1.19                                      |
| Trauma Strap .....                       | 2.04                                      |
| Trays, Storage .....                     | 3.10, 6.04-6.05, 9.04                     |
| Tubes                                    |   |
| Bicycle/Tricycle .....                   | 3.17                                      |
| Tire .....                               | 11.27                                     |
| Tubing, Heat Shrink .....                | 8.39                                      |
| Tune-Up & Planned Maintenance Kits ..... | 5.36                                      |
| Unigauges .....                          | 4.31-4.32                                 |
| Utility Knife & Blades .....             | 1.22                                      |
| UV Flashlight .....                      | 1.03, 9.16                                |
| Valve .....                              | 5.13, 5.57-5.58                           |
| Vaporizer .....                          | 5.11                                      |
| Vest, Safety .....                       | 2.11                                      |
| Washer Fluid .....                       | 1.05                                      |
| Water Pump .....                         | 5.17-5.18                                 |
| Watering, Battery .....                  | 8.21-8.28                                 |
| Welding Jacket .....                     | 2.12                                      |
| Wheel Axles .....                        | 4.33-4.38, 4.49, 4.54, 11.07-11.08, 11.11 |
| Wheels .....                             | 4.44-4.45, 4.53, 11.02-11.11, 11.34-11.50 |
| Caster .....                             | 4.45, 11.07-11.09                         |
| Chocks .....                             | 3.11-3.12, 9.21                           |
| Cylinder .....                           | 5.32-5.33                                 |
| Load Wheel Assemblies .....              | 11.10                                     |
| Load Wheel Kits .....                    | 11.12-11.15                               |
| Non-Polyurethane .....                   | 11.06                                     |
| Dual Tandem Load Wheels .....            | 11.11                                     |
| Polyurethane .....                       | 11.04-11.06                               |
| Quick Change .....                       | 11.10                                     |
| Triple .....                             | 11.11                                     |
| Windshield Washer Fluid .....            | 1.05                                      |
| Wiper                                    |   |
| Blades .....                             | 1.13                                      |
| Towels .....                             | 1.17-1.19                                 |
| Wipes, Cleaner/Disinfectant .....        | 1.10                                      |
| Wire .....                               | 4.19                                      |
| Wire Sets, Ignition .....                | 5.36-5.40                                 |
| Work Assist® .....                       | 6.02-6.08                                 |
| Work Lights .....                        | 4.03-4.05, 4.08, 6.07                     |
| Yale, Hyster, Raymond Parts Breakdown    |   |
| .....                                    | 4.33-4.35, 4.48-4.49                      |











# START UP YOUR SYSTEM OF SAVINGS.



## A full-service parts and service system provider.

Crown doesn't just want to sell parts. By observing how you use your forklift and understanding your specific needs, Crown collaborates to deliver the long-term durability and value you expect.

Combine all this with Crown's forklift quality, replacement part accessibility, part commonality, proven technical service and an operator-friendly, ergonomic design, and you'll experience uptime like no other.

With Crown and our retail network, you'll benefit from:

- ▶ A well-managed dealer parts inventory
- ▶ Quick delivery
- ▶ Online parts ordering
- ▶ Exceptional customer service

**These benefits add up to less downtime, easier and faster parts replacement and longer truck life.**



◀ Our online Parts and Service Resource Tool (PSRT) system allows customers to find exactly what they need.



A Crown Equipment Brand

# Total Truck Power Solutions

Crown offers the resources and expert guidance to build a complete power system for your application:



- **Lead Acid Batteries**
- **Industrial Battery Chargers**
- **Supplies and Accessories**
- **Power Study and Maintenance**

See Section 8  
For the Battery and Charger Section



# Protect Products and Pallets

## Pallet Dawg - Bull Dawg



Pallet Dawg

Bull Dawg

- For high-impact and rigorous applications
- Easy installation with only a few simple parts
- Compatible with any Class II forklift carriage

### Bull Dawg

- Two galvanized steel bars for heavy-duty environments
- For severe cold environments

See Section 7  
InfoLink, PTH50, Chain, Forks and Attachment Parts

## Contact Your Local Dealer:



**Crown Equipment Corporation**  
New Bremen, Ohio 45869 USA  
**Tel** 419-629-2311  
**Fax** 419-629-2099  
crown.com

Because Crown is continually improving its products, specifications are subject to change without notice.

Crown, the Crown logo, the color beige, Crown Integrity Parts, Integrity Parts System, Integrity Service System, Wave, Work Assist, Demonstrated Performance, V-Force, One Source Lift Truck Parts, and InfoLink, are trademarks of the Crown Equipment Corporation in the United States and other countries.

Other trademarks are the property of their respective owners.

Copyright 2021 Crown Equipment Corporation  
PF14434 02-21 Vol. 31 Printed in U.S.A.

Note: 1910.178(q)(5) (1998) of the Occupational Safety and Health Act (OSHA) requires that "All parts of any such industrial truck requiring replacement shall be replaced only by parts equivalent as to safety with those used in the original design."