

Make It Yours

Choose from a variety of options to customize your ride. If you don't see what you need, contact your authorized UniCarriers dealer for help.



Strobe & LED Work Lights

Trucker's Mast

High Air Intake Pre-Cleaner

Overhead Guard-Mounted Fire Extinguisher

Forks with High Visibility Paint

Dual Drive Tires*

* Available on pneumatic tire models only. Standard, pre-drilled holes in thick front fenders simplify field installation of dual tire option. Data plate change is required. Consult factory.

Option Availability

● Standard ○ Optional

	LP	GASOLINE	DUAL FUEL
VEHICLE MANAGEMENT			
Vehicle Control Module (VCM)	●	●	●
Operator security PIN access	●	●	●
Interactive LCD meter panel	●	●	●
On-board diagnostics and programmable service reminders	●	●	●
Engine coolant temperature gauge	●	●	●
Oil pressure, transmission fluid and low coolant warning lights	●	●	●
LPMax low fuel warning	●	—	●
Fuel gauge - gas	—	●	●
SmoothShift system	○	○	○
Starter interlock - low LP	○	—	○
POWERTRAIN			
Electronic Engine Control System	●	●	●
Engine/transmission protection and warning system	●	●	●
Floating powertrain for reduced vibration (pneumatic)	●	●	●
Three-way catalytic converter	●	●	●
Cushioned stability control	●	●	●
Travel speed control (high/low speed selector)	○	○	○
Controlled acceleration (power/economy selector)	○	○	○
Radiator screen	○	○	○
Diffusion exhaust muffler	○	○	○
LP SYSTEM			
Swing-out LP bracket*	●	—	●
Swing-down LP bracket*	○	—	○
BRAKE			
Parking brake with warning buzzer	●	●	●
Parking brake transmission interlock	●	●	●
MAST			
Seat actuated auto-mast lock system	●	●	●
OptiView® three-stage mast	○	○	○
High-Visibility Carriage*	●	●	●
HYDRAULIC SYSTEM			
Single lift/tilt control lever	●	●	●
Separate lift & tilt control levers	○	○	○
Automatic fork leveling*	○	○	○
OPERATOR CONVENIENCES			
Full suspension seat with weight & lumbar adjustment	●	●	●
Overhead guard-mounted LED headlights	●	●	●
Rearview mirrors	○	○	○
Rear LED combination light package (turn, stop, back-up)	○	○	○
Rear LED drive light	○	○	○
Secure rear grip with horn button	○	○	○
PROTECTION /SECURITY			
Operator Presence System with return-to-neutral and auto mast lock	●	●	●
Seatbelt interlocks	○	○	○
UL Safety rating*	○	—	—
Back-up warning alarm	●	●	●
Self-adjusting back up alarm	○	○	○
Fire Extinguisher	○	○	○

*Available on select models. Consult factory.

Specifications

Safety ratings available on select models/fuel types

PNEUMATIC TIRE 3000 – 7000 LB. MODELS

SHORT MODEL CODES	PF30 PF30LP PF30DF	PF35 PF35LP PF35DF	PFS40 PF340LP PFS40DF	PF(U)40 PF(U)40LP PF(U)40DF	PF(U)50 PF(U)50LP PF(U)50DF	PF55 PF55LP PF55DF	PF60 PF60LP PF60DF	PF70 PF70LP PF70DF
Engine Models Available	K21	K21	K21	K21/K25	K21/K25	K25	K25	K25
Load Capacity - lb	3000	3500	4000	4000	5000	5500	6000	7000
Wheelbase - in	55.1	55.1	55.1	63.0	63.0	63.8	66.9	66.9
Overall Width - in	41.9	41.9	41.9	45.3	45.3	49.2	49.2	50.4
Overall Length (no forks) - in	89.0	90.2	91.3	96.9	99.0	102.8	105.5	108.5
Overall Height (OHG) - in	83.3	83.3	83.3	83.5	83.5	84.6	84.6	84.8
Turning Radius (outside) - in	76.2	77.6	79.1	83.5	85.8	88.2	90.6	94.1

CUSHION TIRE 3000 – 8000 LB. MODELS

SHORT MODEL CODES	CF30LP CF30DF	CF35LP CF35DF	CFS40LP CFS40DF	CF40 CF(U)40LP CF(U)40DF	CF50 CF(U)50LP CF(U)50DF	CF55 CF(U)55LP CF(U)55DF	CFS60LP CFS60DF	CF60LP CF60DF	CFS65LP CFS65DF	CF70LP CF70DF	CF80LP CF80DF
Engine Models Available	K21	K21	K21	K21/K25	K21/K25	K21/K25	K25	K25	K25	K25	K25
Load Capacity - lb	3000	3500	4000	4000	5000	5500	6000	6000	6500	7000	8000
Wheelbase - in	46.9	46.9	46.9	55.1	55.1	55.1	55.1	59.1	55.1	59.1	59.1
Overall Width - in	38.2	38.2	38.2	42.1	42.1	43.1	43.1	43.9	43.9	45.9	45.9
Overall Length (no forks) - in	81.9	83.1	84.4	89.0	91.3	93.9	95.3	96.5	96.3	98.2	100.0
Overall Height (OHG) - in	81.1	81.1	81.1	82.1	82.1	82.1	82.1	82.3	82.1	82.3	82.3
Turning Radius (outside) - in	68.3	69.5	70.9	76.0	78.3	79.5	80.7	80.9	81.5	82.5	83.9

COMPACT PNEUMATIC TIRE (NOMAD) 3000 – 5000 LB. MODELS

SHORT MODEL CODES	AF30LP AF30DF	AF35LP AF35DF	AF50LP AF50DF
Engine Models Available	K21	K21	K21
Load Capacity - lb	3000	3500	5000
Wheelbase - in	50.8	50.8	59.1
Overall Width - in	40.7	40.7	46.3
Overall Length (no forks) - in	83.9	85	92.9
Overall Height (OHG) - in	83	82.7	82.3
Turning Radius (outside) - in	72.6	73.8	80.7

ENGINES

ENGINE MODELS	K21 (2.1 LITER) GAS, LPG, DUAL FUEL	K25 (2.5 LITER) GAS, LPG, DUAL FUEL
Displacement - cu in	126	151.8
Rated Output - hp/rpm	55 / 2700	62.9 / 2700
Rated Torque - ft-lb/rpm	111.4 / 2000	138.7 / 1600

Platinum II® Series Applications

Powered by our GTC K21 and K25 engines, the Platinum II sets the standard for performance, using less fuel and delivering more cycles per hour in a variety of demanding applications that include:

- Manufacturing
- Warehousing
- Recycling
- Beverage/Bottling
- Trucking



NEVER QUIT.

It defines our forklifts and the company that builds them.

Over the course of a century, the company known as UniCarriers took shape. As we grew and evolved into a US manufacturer with a global reach in nearly 100 countries worldwide, much has changed, but one thing hasn't: our mission. UniCarriers is committed to providing you with the ultimate in reliability, performance, and value.

And that commitment can be seen in the Platinum II Series. Powered by our legendary K21 and K25 industrial engines, our rugged Platinum II forklifts deliver greater torque and horsepower...reduce CO, HC and NOx exhaust emissions...and come standard with some of the most advanced performance, security and operator comfort features available anywhere. Plus, it's all backed by the best standard, limited warranty in the business.



Up Your UpTime

Discover reliability features that cut downtime and keep your business up and running



Comfort Zone

Your drivers and your entire operation will benefit from our comfort & productivity features



Power & Performance

You'll find amazing efficiency, reliability and performance in our K21 and K25 engines



Sweet Savings

The Platinum II is designed to deliver you a low cost of ownership year after year after year



Play It Safe

Safety is everybody's business, and the Platinum II is all business when it comes to safety



Control Freak

You're in complete control when it comes to managing costs and productivity



Versatility & Value

Discover how our unique design can help you improve performance indoors and out



Make It Yours

Already well appointed, Platinum II can be customized to meet your specific needs



To learn more, and a find a dealer near you, visit UniCarriersAmericas.com



Look for these symbols for features available only on UniCarriers forklifts or that provide a proven performance advantage as compared to competitive trucks.

Up Your UpTime

Trained technicians can **program service interval alerts** for each unit in operation through the meter panel. Drivers are notified when scheduled maintenance is required.

When it comes to keeping your operation up and running, the Platinum II Series offers you significant advantages, beginning with a reliable cooling design, service reminders and longer maintenance intervals. Throughout the Platinum II you'll find innovative and proven protection and warning systems to help you maximize uptime, while minimizing cost.

Longer Preventative Maintenance Intervals

With the Platinum II Series, most major service intervals are only required every 500-600 hours, reducing labor and lowering your operating costs.



A standard **parking brake transmission interlock** keeps the forklift in neutral and prevents the operator from driving while the parking brake is engaged to protect the brakes and transmission and reduce premature brake wear.



Inhibit operators from shifting at high speeds with our **SmoothShift** system. This option limits transmission shock and excessive wear— and extends service life too.



Easy LP Tank Changes

With our simplified LP replacement system, an optional bracket swings out 90°, then pulls down to a manageable height, for faster, easier tank replacement. *Not available on all models.*

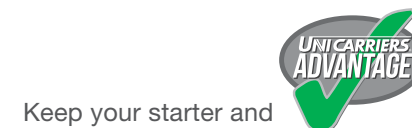

Keep your starter and battery healthy with a **starter interlock**. This optional equipment **protects the forklift's starting system** by restricting repeated attempts to start the engine when the LP system is out of fuel.

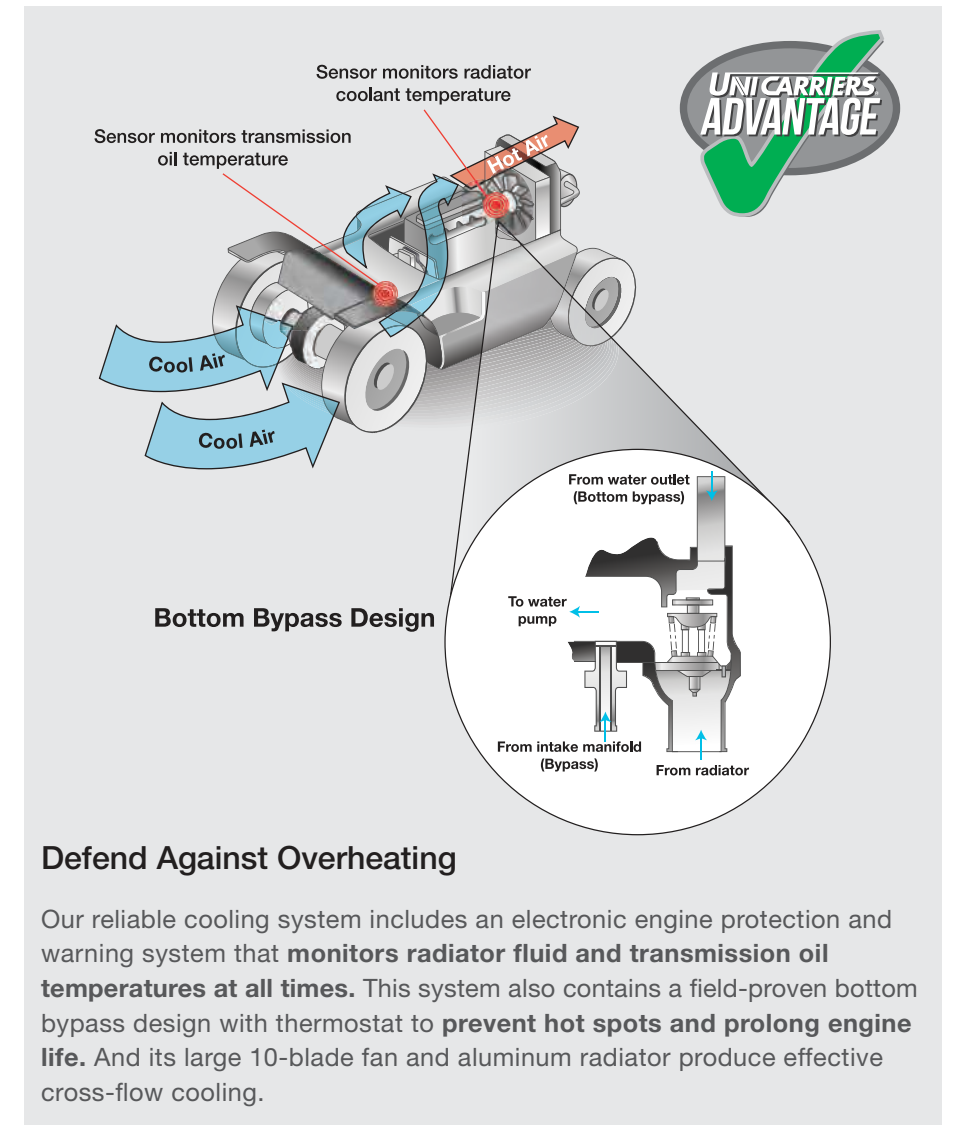

Defend Against Overheating

Our reliable cooling system includes an electronic engine protection and warning system that **monitors radiator fluid and transmission oil temperatures at all times**. This system also contains a field-proven bottom bypass design with thermostat to **prevent hot spots and prolong engine life**. And its large 10-blade fan and aluminum radiator produce effective cross-flow cooling.

Reduce Downtime through Self-Diagnostics

Integrated **on-board diagnostics** provides immediate truck status. Standard equipment on the Platinum II Series, this intuitive dialogue display, combined with accessible service history, **reduces troubleshooting time**, so the unit is back in operation faster. Everything is done through its smart LCD panel. No handset device is needed.



Comfort Zone

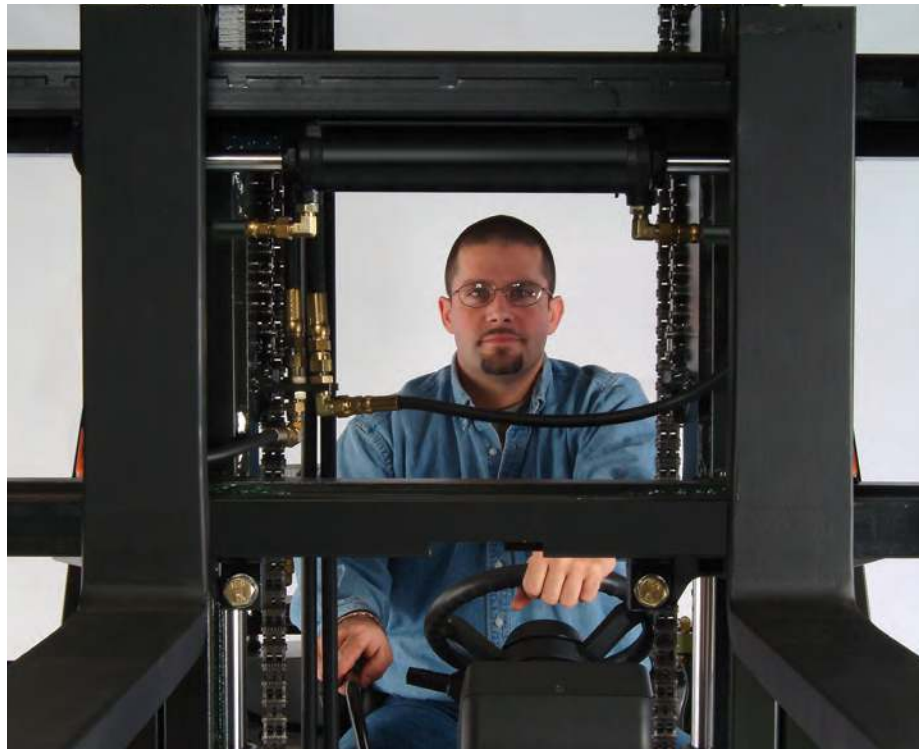

Superior Visibility

A standard high-visibility carriage* and your choice of an OptiView®, triple stage or wide-view mast — together these features produce clear sightlines for both loading and moving.

**Available at no additional cost on model capacities up to 5500 lbs.*



Improved Control and Security

Maneuverability during reverse driving is easier with an optional secure assist grip. And it helps keep the operator's hand inside the compartment where it belongs. A horn button is included.



Convenience at Your Fingertips

Standard automotive-style controls are located on either side of the steering column for accessibility and intuitive operation.



Get a Smoother Ride

Pneumatic tire models are designed with a floating powertrain that includes four independent dampers, to reduce vibrations that can cause operator fatigue.

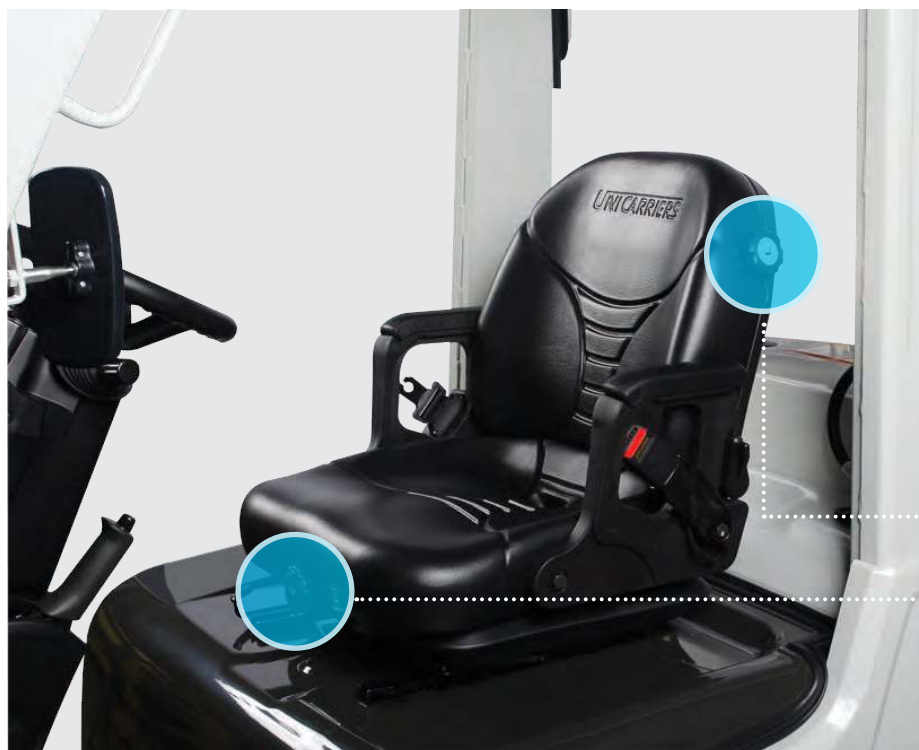

Our Seat Supports Your Driver and Your Productivity

The lumbar support and weight adjustments create customized comfort for the operator, while a non-cinching seatbelt allows a wider range of movement. The full suspension design absorbs shocks for a smoother, more comfortable ride — and it's all standard on Platinum II Series forklifts.

Lumbar support adjustment

Weight adjustment

Seat and backrest cushions can be individually replaced for enhanced savings.

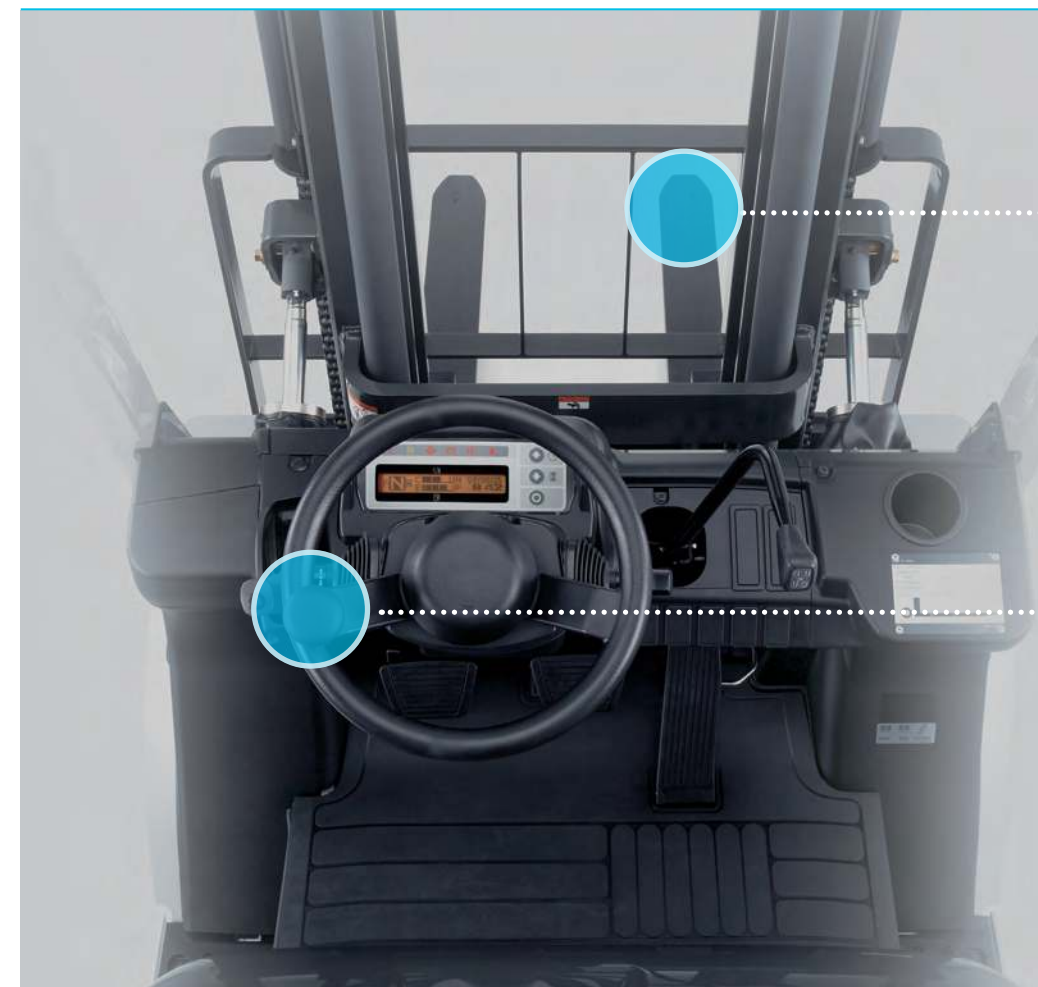

Better Fork Tip Visibility

Controls are ergonomically placed across a low profile cowl, making visibility while picking up loads easier for a variety of operator heights.

Add a Spinner Knob for Easier Handling

Operators love this optional feature because it gives them even easier control behind the wheel.

Power & Performance

Operator Efficiency Achieved

Choose the optional integral side shifter resulting in fewer moves to store and retrieve loads, while minimizing capacity loss versus hang-on designs.



More Power, More Efficiently

Advanced engine technology makes it possible for our K21 and K25 engines to deliver **greater torque at lower RPMs**. This is achieved due to a combination of factors, including **direct ignition coils connected to each cylinder**, a centrally positioned spark plug on the combustion chamber as well as electronic monitoring and control systems. Platinum II models also include an atmospheric sensor that delivers enhanced performance in high altitudes.



Paired for Maximum Performance

Built to our specifications, the Platinum II's transmission is uniquely designed to **optimize the horsepower and torque of our K21 and K25 industrial engines**. This proven drivetrain delivers powerful, yet efficient performance.

Cleaner Running Engines for Greater Performance



The injector valve's powerful opening force aids in conditions where lower quality LP fuel is used. Gas is located under the valve to **help reduce possible tar build up on the injectors** which can adversely affect performance. A pressure sensor is located between the two injectors.

Consistent Performance through Reliable Technology

The Platinum II's engine and vehicle control modules along with multi-function display communicate through a reliable CAN-bus network to manage changing system requirements and maintain consistent performance.



Built for Rugged Dependability

Solid steer axles and thick steel front fenders provide protection against harsh work environments.



Compact Design

A small steering wheel and intuitive controls make these trucks highly suited for maneuverable performance within confined areas of the warehouse.



The Nomad's standard Power setting allows you to achieve maximum performance — and an annual productivity increase of up to 2500 cycles per truck.

Study findings are based on a 1200-hour usage

SELECT POWER SETTING FOR GREATER PRODUCTIVITY

PLATINUM II SERIES

BRAND A

BRAND B

50 51 52 53 54 55

Cycles per Hour

Switch to the Platinum II's optional Economy mode to get greater fuel efficiency. Independent testing has shown our K21 engines use nearly 11% less fuel compared to competitive models under unloaded conditions.*

** Results based on 5000 lb. capacity LP cushion tire models in Economy mode.*

SELECT ECONOMY SETTING FOR FUEL SAVINGS

PLATINUM II SERIES

BRAND A

BRAND B

4 5 6 7 8

Fuel Usage in Pounds per Hour

Sweet Savings



Extra Protection Without Extra Expense



In the event of excessive heat or loss in engine oil pressure, our **Powertrain Protection System** reduces engine RPM for longer engine and drivetrain life. This great feature is standard on models powered by our K21 and K25 engines, versus competitive forklifts requiring a costly add-on.

Reduce Tire Wear & Save Fuel



Our power/economy controlled acceleration feature restricts the acceleration rate to **maximize fuel economy and minimize tire spin**. Gradual acceleration is also **useful when moving fragile loads or operating in confined areas**. Three design choices for this option offer increasingly more **security against tampering**: toggle switch, key switch or set internal parameters to keep this feature activated.

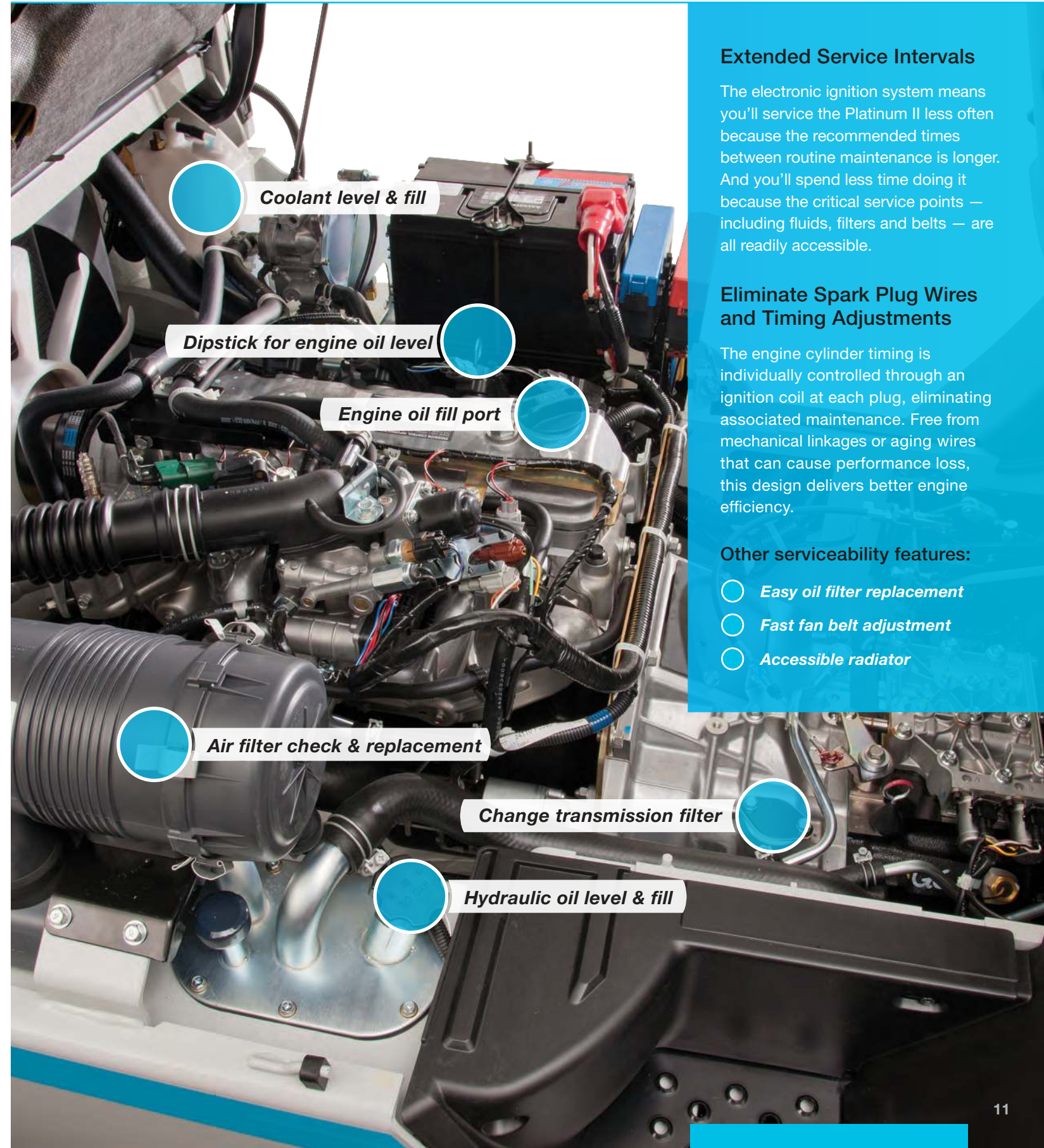

Coolant level & fill

Dipstick for engine oil level

Engine oil fill port

Air filter check & replacement

Change transmission filter

Hydraulic oil level & fill

Extended Service Intervals

The electronic ignition system means you'll service the Platinum II less often because the recommended times between routine maintenance is longer. And you'll spend less time doing it because the critical service points — including fluids, filters and belts — are all readily accessible.

Eliminate Spark Plug Wires and Timing Adjustments

The engine cylinder timing is individually controlled through an ignition coil at each plug, eliminating associated maintenance. Free from mechanical linkages or aging wires that can cause performance loss, this design delivers better engine efficiency.

Other serviceability features:

- Easy oil filter replacement
- Fast fan belt adjustment
- Accessible radiator



Long Life LEDs

Everything about the Platinum II is designed for longer life and greater savings, including the standard LED headlights that deliver greater visibility while being more economical and cost-effective over the life of the machine.

Repositionable Headlights



Save More, Waste Less



With the Platinum II's **standard LPM_{ax} System** nearly every drop of liquid LP is used thanks to its reliable and timely low fuel warning, **reducing early tank replacement and saving you money**. An average 8-minute* warning means the operator can maximize productivity — instead of lugging an empty tank to the refill station.



Our Overhead Guard Reduces Your Overhead

Beyond ample headroom, the five-piece overhead guard takes **75% less time to make needed replacements** versus competitors' single-piece, welded-on guards. That cuts downtime and costs.

*Based on typical traveling operation in unloaded condition. Time interval varies depending upon individual application and usage.

Play It Safe

As a leader in clean air engines for nearly a decade, our products have benefited from the knowledge gained through our automotive heritage. Our K21 and K25 industrial engines incorporate an electronic engine control system, using a closed loop design to produce high combustion efficiency with lower and cleaner emission levels. We've also included several security systems as standard, and more options to meet your particular needs.



For Even Greater Security

Several options are available for added protection:

- **Seatbelt Interlocks** include a variety of choices for restricting forklift operations if the seatbelt is not latched.
- **Fire Extinguisher** mounted to the overhead guard pillar, for quick and easy access.
- **Orange Seatbelt** is highly visible, making seatbelt usage easier to enforce.
- **LP Safety Rating** is UL approved.

Operator Presence System



This comprehensive system includes a **seat-actuated power interrupt with mast-lock**, automatically preventing lift and tilt operations if the operator leaves the seat. The **return-to-neutral** feature minimizes forklift movement if the operator leaves the truck while still in gear. Other audible and visual warnings come standard, including **parking brake warning** and **seatbelt alarm**.



A rubber damper provides enhanced stability and easier handling



Safety Doesn't Have to be Complicated

Unlike the complex systems offered by some competitors, our cushioned stability control is simple, extremely effective and **zero maintenance** — enhanced lateral stability is achieved by a rubber damper placed between the axle and frame.

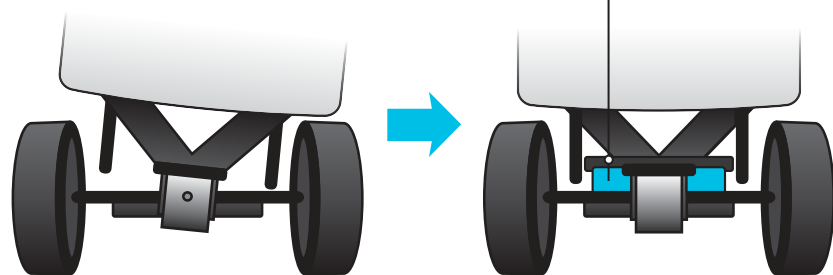

Seeing is Believing

Cylinders are positioned behind the mast rails resulting in fewer visual obstructions for the operator. Ideal for facilities that transport delicate loads, our optional OptiView® mast makes fork positioning and load handling easier.



OSHA strictly regulates carbon monoxide (CO) levels in the workplace for good reason.



The Platinum II's CO levels are among the lowest in its engine class — three times lower than those of a major competitor based on 2015 certification results from the California Air Resources Board.

We achieved these lower and cleaner emission levels through the higher combustion efficiency delivered by our electronic engine control system that incorporates a Vehicle Control Module (VCM), Engine Control Module (ECM) and a 3-way catalytic muffler.

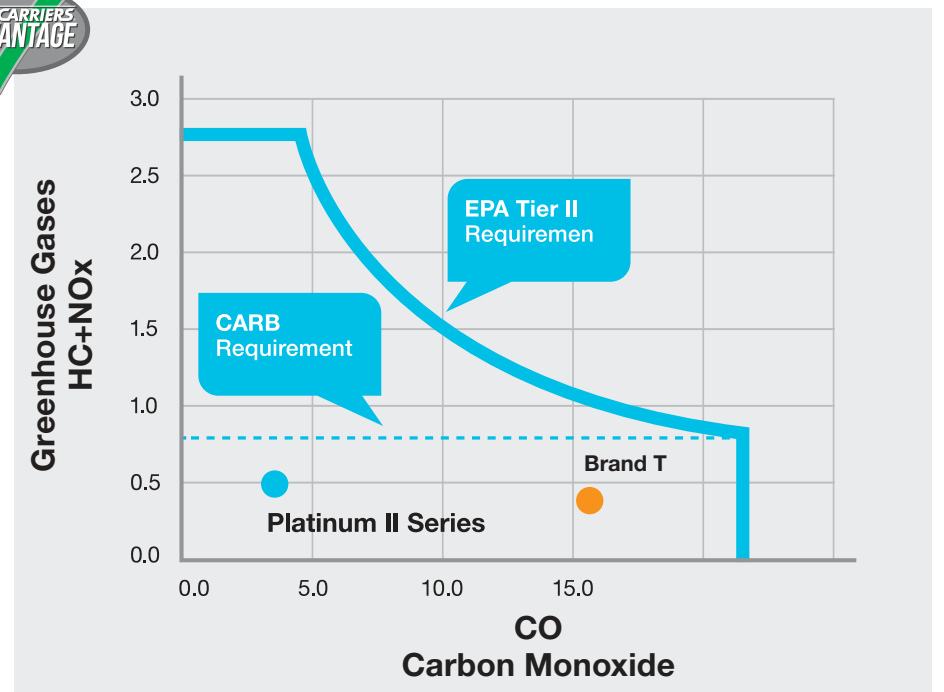

*Based on 2015 CARB certification results.

Control Freak

Make a Positive Impact

A variety of optional impact sensors are available to record each time the forklift comes into contact with a stationary object, allowing you to respond accordingly.

Single Handle Control Lever

Faster, easier and more fluid, our single handle control combines both lift and tilt functions for greater productivity. It's standard equipment on the Platinum II Series — and not available from any other forklift brand. Separate control levers are available at no charge.



Auto-Tilt Leveling System

Press the button on the hydraulic control lever to tilt the forks forward to a horizontal position. This option is used for easier load placement and retrieval operations.



Parking Brake Alarm

As part of the Operator Presence System, a warning buzzer alerts the driver if he leaves the seat without first setting the parking brake.

Forward Thinking Back-Up Alarm

Our standard back-up alarm provides plenty of notice to pedestrians and other drivers in the area. For applications with varying noise levels, there is an optional self-adjusting alarm that adjusts sound volume based on ambient noise levels.



Find Your Top Travel Speed Easier



With an optional speed switch, drivers can toggle from a high speed pre-set in one area then select a low speed, confident they are adhering to corporate requirements*.



Select the security key switch option to lock in a pre-set high or low speed*.

Set Travel Speeds Without Losing Productivity

Top travel speed is electronically controlled, so you won't sacrifice lift performance. The great news? No tools are needed to set desired speeds*.

* Speed pre-sets performed by trained service technician

The Ultimate in Control

The interactive meter panel on the Platinum II Series provides operators and technicians with a wealth of information through its LCD warnings and readouts. A visual indicator for its return-to-neutral feature shows the forklift's transmission direction.

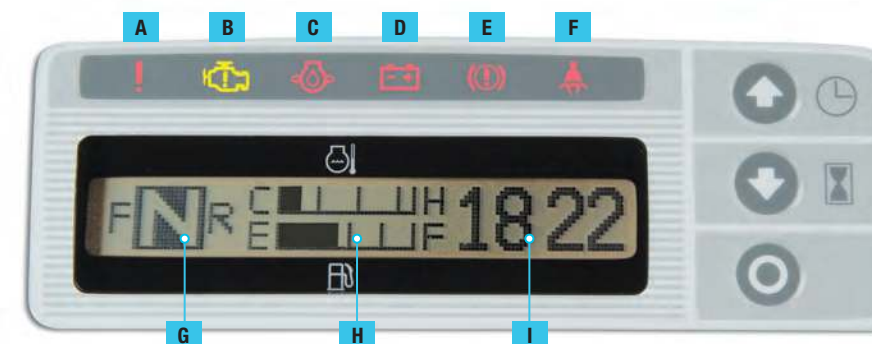

Our multi-function display provides an at-a-glance view of critical functions:

- A** Multipurpose warning
- B** Check engine warning
- C** Oil pressure warning
- D** Charge warning
- E** Parking brake warning
- F** Seatbelt warning
- G** Directional indicator
- H** Fuel & water temperature gauges
- I** Multi-function display:
 - Hour meter
 - Clock/calendar
 - Speedometer
 - Programmable service reminder
 - Error codes

Reliability.

It's the defining trait of our company and our forklifts.



UniCarriers' roots extend back over 100 years, and over that time, strong, reliable performance has always been the hallmark of our organization, our people and our equipment.

Today, our unrivaled reliability continues to provide UniCarriers' customers with a competitive edge. And together, we move the merchandise that moves world commerce with greater efficiency, economy and reliability.

When it comes to providing forklifts that make a difference for our customers and theirs...

We Never Quit.



Engine Powered Forklifts

Gas, LP, Dual Fuel
3,000 - 8,000 lbs. Capacities | Cushion Tire
3,000 - 7,000 lbs. Capacities | Pneumatic Tire



Platinum II® Series



Debris Resistance Package
 Includes a belly screen and slotted wheel well inserts to prevent larger debris from entering the engine compartment and affecting key components. For additional protection, select the Recycler Package.



Blue LED Pedestrian Awareness Light
 Reverse driving actuates an optional blue spotlight to illuminate the floor, for advanced visual warning.



Tilt Cylinder Protection
 Cylinder boots and covers provide extra protection against contaminants that can cause premature wear on cylinder packing.



Extended Overhead Guard
 Extension provides protection to mounted components, including on-board computer and headlight (shown).



Fingertip Controls
 Increase operator productivity with ergonomic hydraulic controls. Choose single joystick or multiple lever designs.



Polycarbonate Overhead Guard Cover
 Prevents small debris from entering the operator compartment through the overhead guard.



Sideshifting Fork Positioner
 Hydraulically positions forks, eliminating the need for manual adjustment by the operator, providing increased productivity.



Rear LED Combination Lights
 Package includes a reflector, turn signals, brake and back-up lights. Design provides high visibility and vibration resistance for long life and low service costs. Choose vertical or horizontal mounting (shown).



Radiator Screen
 Minimizes debris entering radiator, resulting in more efficient engine cooling.

Versatility and Value

The Nomad Series



Don't downsize your fleet – right size it. A proven performer across a variety of applications, the Nomad is bound to be one of the most relied upon forklifts in your facility. From loading dock to work yard, you'll discover the many ways these flexible trucks will benefit your operation.



*Calculations based on comparison of Nomad vs. pneumatic tire forklift of same capacity.

Two Forklifts in One

The Nomad Series is a UniCarriers exclusive. At home anywhere, its cushion tire-sized chassis rides on solid pneumatic tires to deliver exceptional performance both indoors and out. And because our Nomad is part of the Platinum II family, you'll also enjoy the same reliability that comes with utilizing UniCarriers brand equipment in your operation.

For Indoor and Outdoor Use

The Nomad Series is available in 3000, 3500 and 5000 lb. lifting capacities. Its short wheelbase and tight turning radius mean it's sized like a standard cushion tire forklift, offering precise maneuverability in confined areas. But don't let its size fool you. It's just as effective in tough outdoor applications. And it offers higher capacity retention versus comparable pneumatic tire trucks.

Operate on improved surfaces for best outdoor performance results.



Get up to 8% tighter turning radius without sacrificing capacity.*

72.6-87.5
INCHES